

PART NUMBER	SML-LXR851USBC-TR	REV.	C
DATE	E.C.N. NUMBER AND REVISION COMMENTS		REV.
09.07.04	E.C.N. #10967.		A
11.14.07	E.C.N. #11148.		B
05.16.11	E.C.N. #11710/#11721/10BRDR. & REDRAWN.		C

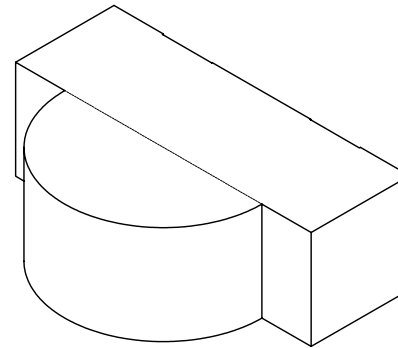
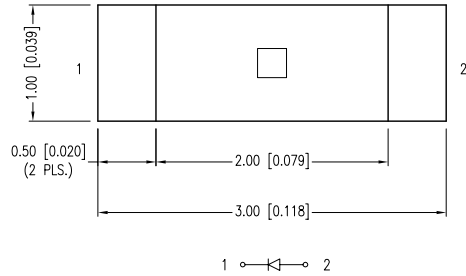

**C** ELECTRO-OPTICAL CHARACTERISTICS TA =25°C If=20mA

PARAMETER	MIN	TYP.	MAX	UNITS	TEST COND
PEAK WAVELENGTH		468		nm	
FORWARD VOLTAGE		3.3	3.7	Vf	
REVERSE VOLTAGE	5.0			Vr	If=100µA
AXIAL INTENSITY		50		mcd	If=20mA
VIEWING ANGLE		120		2x theta	
EMITTED COLOR:	BLUE				
EPOXY LENS FINISH:	WATER CLEAR				

**C** LIMITS OF SAFE OPERATION AT 25°C

PARAMETER	MAX	UNITS
PEAK FORWARD CURRENT*	100	mA
STEADY CURRENT	25	mA
POWER DISSIPATION	110	mW
DERATE FROM 25°C	-1.2	mW/°C
OPERATING TEMP.	-40 TO +85	°C
STORAGE TEMP.	-40 TO +85	°C

\* t<10µs

**C** **A** CAUTION: MOISTURE SENSITIVE DEVICE  
PER JEDEC LEVEL 2 STANDARDS

CAUTION: STATIC SENSITIVE DEVICE  
FOLLOW PROPER E.S.D. HANDLING PROCEDURES  
WHEN WORKING WITH THIS PART.

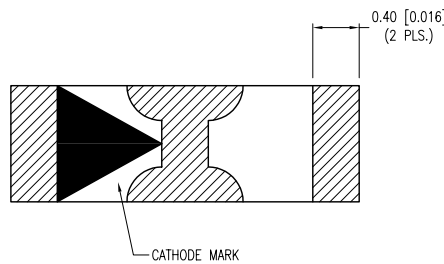
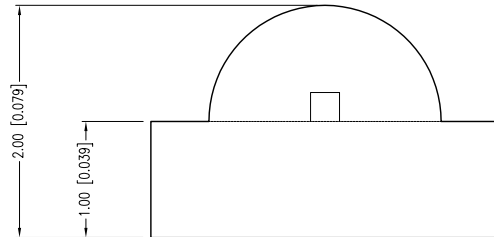

RECOMMENDED SOLDER PAD LAYOUT

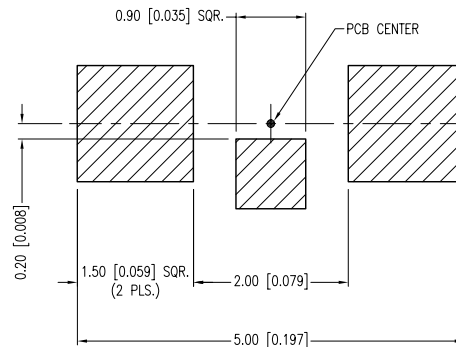

\*UNLESS OTHERWISE SPECIFIED TOLERANCES PER DECIMAL PRECISION ARE: X=±1 (±0.039), X.X=±0.5 (±0.020), X.XX=±0.25 (±0.010), X.XXX=±0.127 (±0.005). LEAD SIZE=±0.05 (±0.002), LEAD LENGTH=±0.75 (±0.030). MIN.= +DECIMAL PRECISION MAX.= +0.00 -DECIMAL PRECISION

**LUMEX**  
Creating LED and LCD Solutions Together™  
290 E. HELEN ROAD  
PALATINE, IL 60067-6976  
PHONE: +1.847.359.2790  
FAX: +1.847.359.6538  
WEB: WWW.LUMEX.COM

1.0x3.0mm PCB RIGHT ANGLE SURFACE MOUNT LED, 468nm SUPER BLUE LED, WATER CLEAR LENS, TAPE & REEL.

\*\*THE SPECIFICATIONS MAY CHANGE AT ANY TIME WITHOUT NOTICE DUE TO NEW MATERIALS OR PRODUCT IMPROVEMENT.\*\*

CONFIDENTIAL INFORMATION  
THE INFORMATION CONTAINED IN THIS DOCUMENT IS THE PROPERTY OF LUMEX INC. EXCEPT AS SPECIFICALLY AUTHORIZED IN WRITING BY LUMEX INC., THE HOLDER OF THIS DOCUMENT SHALL KEEP ALL INFORMATION CONTAINED HEREIN CONFIDENTIAL AND SHALL PROTECT SAME IN WHOLE OR IN PART FROM DISCLOSURE AND DISSEMINATION TO ALL THIRD PARTIES.

DATE:	05.16.11	DRAWN BY:	AB
PAGE:	1 OF 2	CHKD BY:	BC
SCALE:	NTS	APRVD BY:	KF
UNIT:	mm [INCH]		Ⓟ

PART NUMBER	SML-LXR851USBC-TR	REV.	C
DATE	E.C.N. NUMBER AND REVISION COMMENTS		REV.
09.07.04	E.C.N. #10967.		A
11.14.07	E.C.N. #11148.		B
05.16.11	E.C.N. #11710/#11721/10BRDR. & REDRAWN.		C

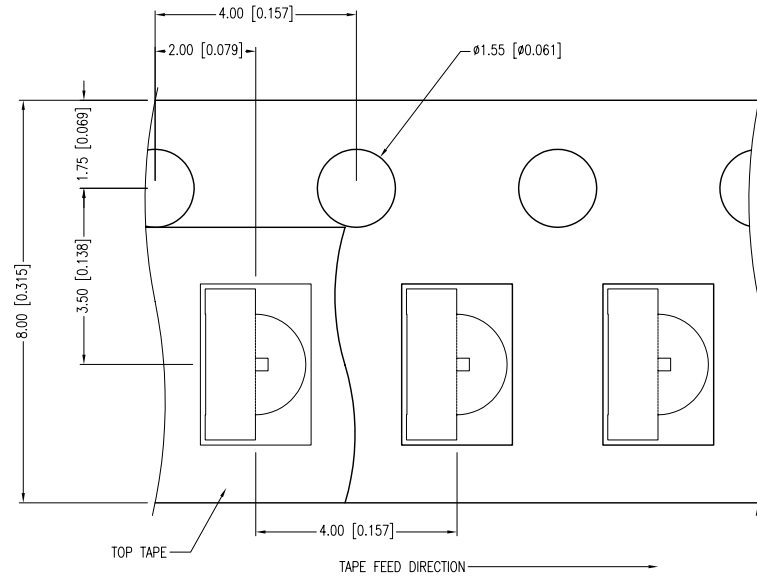
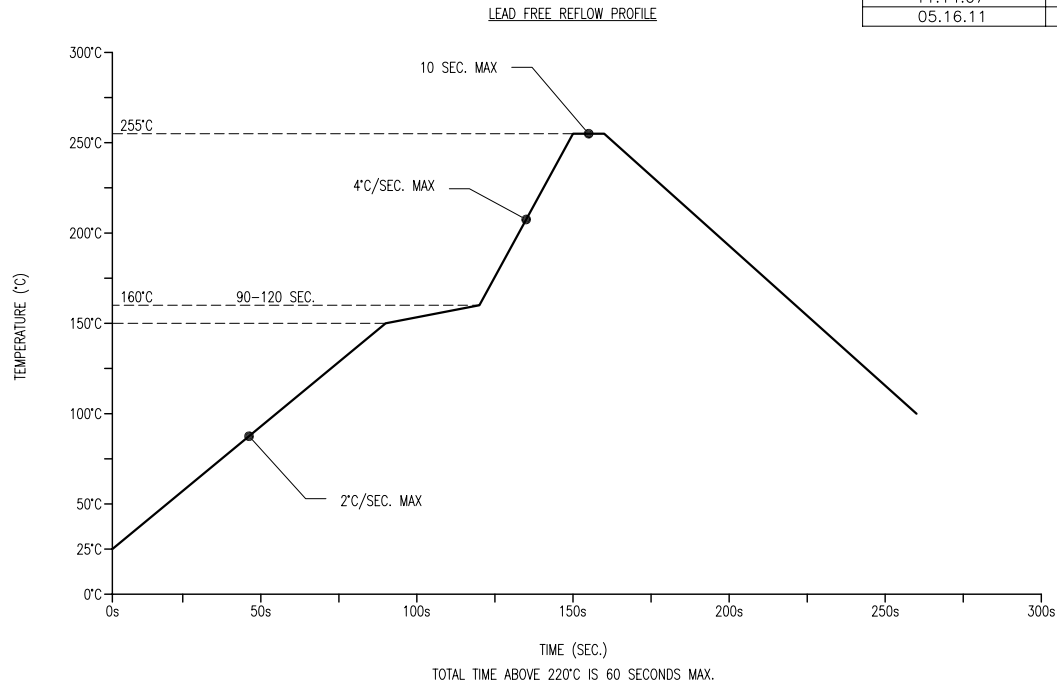

- NOTES:**
- 2,000 PER REEL.
  - THE CATHODE IS ORIENTED TOWARDS THE TAPE SPROCKET HOLE.

\*UNLESS OTHERWISE SPECIFIED TOLERANCES PER DECIMAL PRECISION ARE: X=±1 (±0.039), X.X=±0.5 (±0.020), X.XX=±0.25 (±0.010), X.XXX=±0.127 (±0.005). LEAD SIZE=±0.05 (±0.002), LEAD LENGTH=±0.75 (±0.030). MIN= <sup>+DECIMAL PRECISION</sup> -0.00 <sub>-DECIMAL PRECISION</sub>



290 E. HELEN ROAD  
PALATINE, IL 60067-6976  
PHONE: +1.847.359.2790  
FAX: +1.847.359.6538  
WEB: WWW.LUMEX.COM

1.0x3.0mm PCB RIGHT ANGLE SURFACE MOUNT LED, 468nm SUPER BLUE LED, WATER CLEAR LENS, TAPE & REEL.

\*\*THE SPECIFICATIONS MAY CHANGE AT ANY TIME WITHOUT NOTICE DUE TO NEW MATERIALS OR PRODUCT IMPROVEMENT.\*\*

CONFIDENTIAL INFORMATION  
THE INFORMATION CONTAINED IN THIS DOCUMENT IS THE PROPERTY OF LUMEX INC. EXCEPT AS SPECIFICALLY AUTHORIZED IN WRITING BY LUMEX INC., THE HOLDER OF THIS DOCUMENT SHALL KEEP ALL INFORMATION CONTAINED HEREIN CONFIDENTIAL AND SHALL PROTECT SAME IN WHOLE OR IN PART FROM DISCLOSURE AND DISSEMINATION TO ALL THIRD PARTIES.

DATE:	05.16.11	DRAWN BY:	AB
PAGE:	2 OF 2	CHKD BY:	BC
SCALE:	NTS	APRVD BY:	KF
UNIT:	mm [INCH]		(Pb)