

REV.	E.C.N. NUMBER AND REVISION COMMENTS	DATE
A	E.C.N. #11073.	12.31.03

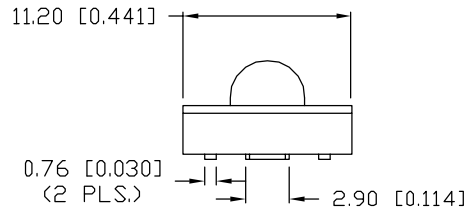
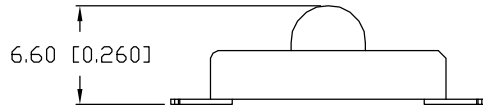
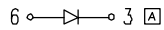
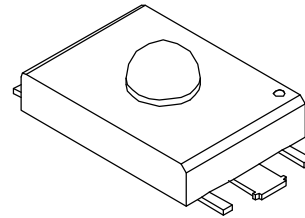
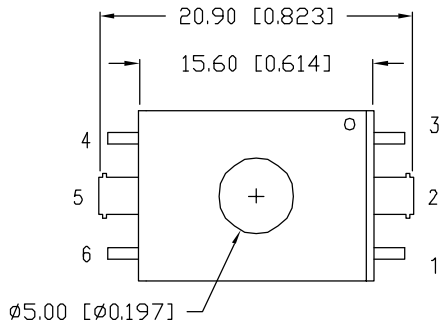

ELECTRO-OPTICAL CHARACTERISTICS $T_A=25^\circ\text{C}$ $I_f=120\text{mA}$

PARAMETER	MIN	TYP	MAX	UNITS	TEST COND
PEAK WAVELENGTH		470		nm	
FORWARD VOLTAGE		3.4	4.0	V_f	
REVERSE VOLTAGE	5.0			V_r	$I_r=100\mu\text{A}$
AXIAL INTENSITY		4.0		cd	$I_f=120\text{mA}$
TOTAL FLUX		2.0		Lm	$I_f=120\text{mA}$
VIEWING ANGLE			30	2x theta	
EMITTED COLOR:	BLUE				
EPOXY LENS FINISH:	WATER CLEAR				

LIMITS OF SAFE OPERATION AT 25°C

PARAMETER	MAX	UNITS
PEAK FORWARD CURRENT*	250	mA
STEADY CURRENT	120	mA
POWER DISSIPATION	420	mW
DERATE FROM 25°C	-1.2	$\text{mW}/^\circ\text{C}$
OPERATING TEMP.	-20 TO +80	$^\circ\text{C}$
STORAGE TEMP.	-35 TO +85	$^\circ\text{C}$

* $t < 10\mu\text{s}$

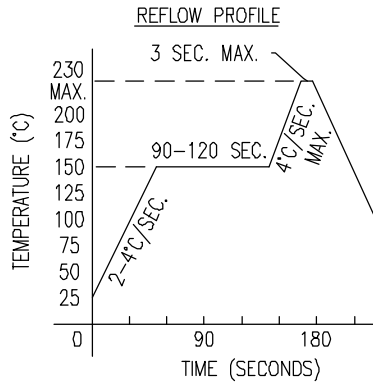

RECOMMENDED SOLDER PAD LAYOUT

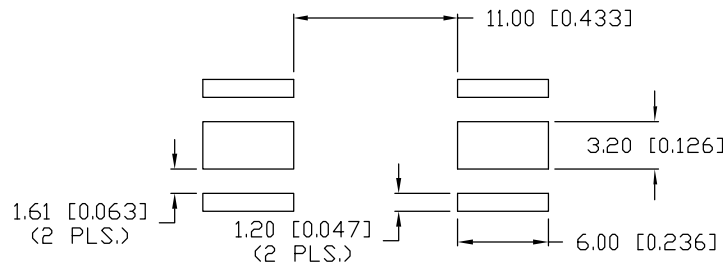

NOTES:

- PARTS ARE PACKAGED IN ANTI-STATIC TUBES.

CAUTION: STATIC SENSITIVE DEVICE
FOLLOW PROPER E.S.D. HANDLING PROCEDURES
WHEN WORKING WITH THIS PART.

*UNLESS OTHERWISE SPECIFIED TOLERANCES PER DECIMAL PRECISION ARE: X=±1 (±0.039), X.X=±0.5 (±0.020), X.XX=±0.25 (±0.010), X.XXX=±0.127 (±0.005). LEAD SIZE=±0.05 (±0.002), LEAD LENGTH=±0.75 (±0.030). MIN= $\frac{+}{-}$ DECIMAL PRECISION MAX= $\frac{+0.00}{-0.00}$ DECIMAL PRECISION

REV. A	PART NUMBER SSP-LX6144C7UC
30° VIEWING LUXLED, 470nm BLUE, WATER CLEAR LENS.	

CONFIDENTIAL INFORMATION
THE INFORMATION CONTAINED IN THIS DOCUMENT IS THE PROPERTY OF SUNBRITE LEDS. EXCEPT AS SPECIFICALLY AUTHORIZED IN WRITING BY SUNBRITE LEDS, THE HOLDER OF THIS DOCUMENT SHALL KEEP ALL INFORMATION CONTAINED HEREIN CONFIDENTIAL AND SHALL PROTECT SAME IN WHOLE OR IN PART FROM DISCLOSURE AND DISSEMINATION TO ALL THIRD PARTIES.

RELIABILITY NOTE
OUR MANY YEARS OF EXPERIENCE DATA ACCUMULATION INDICATE THAT SOLDER HEAT IS A MAJOR CAUSE OF EARLY AND FUTURE FAILURE. PLEASE PAY ATTENTION TO YOUR SOLDERING PROCESS.

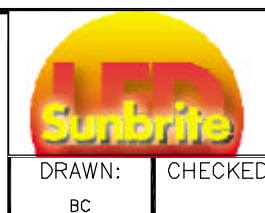

286 E. HELEN ROAD
PALATINE, IL 60067-6976
PHONE: +1.847.348.3116
FAX: +1.847.359.2867
WEB: www.sunbriteleds.com

DRAWN: BC	CHECKED:	APPROVED:	DATE: 7.18.03 PAGE: 1 OF 1
--------------	----------	-----------	-------------------------------