

For NEW designs consider
this replacement product:

• LUXEON 3014

LUXEON 4014

A compact footprint delivering high efficacy and just the right amount of light

LUXEON 4014 is a 2.9V low-power product, the first of its kind from Lumileds. It is a compact QFN 4.0mm x 1.4mm x 0.7mm package that delivers the Quality of Light needed for indoor lighting applications. LUXEON 4014 offers an ideal solution when uniformity and a smooth lighting appearance are critical in luminaire designs.



FEATURES AND BENEFITS

- Rectangular QFN package design increases uniformity
- Superior heat dissipation enables cost effective design
- Unique phosphor technology enables high efficacy
- 1/6th ANSI color binning for tight color control
- Superior heat dissipation enables cost effective thermal design

PRIMARY APPLICATIONS

- Indoor Area Lighting

Table of Contents

| | |
|--|----|
| General Information | 2 |
| Product Nomenclature | 2 |
| Average Lumen Maintenance Characteristics | 2 |
| Environmental Compliance | 2 |
| Product Performance and Characterization Guide | 3 |
| Electrical Characteristics | 3 |
| Absolute Maximum Ratings | 4 |
| JEDEC Moisture Sensitivity | 4 |
| Reflow Soldering Characteristics | 5 |
| Material Information & Mechanical Dimensions | 6 |
| Characteristic Curves | 7 |
| Typical Forward Current | 9 |
| Light Output Characteristics | 10 |
| Typical Radiation Patterns | 11 |
| Emitter Pocket Tape Packaging | 12 |
| Emitter Reel Packaging | 13 |
| Product Binning and Labeling | 14 |
| Color Bin Structure | 15 |

General Information

Product Nomenclature

LUXEON 4014 is tested and binned at $T_j = 25^\circ\text{C}$ and 30mA DC.

The part number designation is explained as follows:

M X Z A – B C D D – 0 0 E E

Where:

- A — designates minimum CRI (value 8 for 80, 9 for 90)
- B — designates radiation pattern (value P for Lambertian)
- C — designates color (W for White)
- DD — designates nominal CCT (27 for 2700K, 30 for 3000K, 35 for 3500K, 40 for 4000K and 50 for 5000K)
- EEEE — designates additional part numbers

Therefore 4000K, 80CRI LUXEON 4014 product will be:

M X Z 8 – P W 4 0 – 0 0 0 0

Average Lumen Maintenance Characteristics

The LUXEON 4014 is being tested in accordance with LM-80 standards. Please contact your Lumileds TSM or sales person for more detailed information.

Environmental Compliance

Lumileds is committed to providing environmentally friendly products to the solid-state lighting market. LUXEON 4014 is compliant to the European Union directives on the restriction of hazardous substances in electronic equipment, namely the RoHS and REACH directives. Lumileds will not intentionally add the following restricted material to the LUXEON 4014: lead, mercury, cadmium, hexavalent chromium, polybrominated biphenyls (PBB) or polybrominated diphenyl ethers (PBDE).

Product Performance and Characterization Guide

Typical Product Characteristics at 30mA and 60mA

Table 1. Performance Characteristics at $T_j = 25^\circ\text{C}$, I_f

| Nominal CCT | Part Number | Minimum CRI | Luminous Flux @ 30mA, 25°C | | Luminous Flux @ 60mA, 25°C | | V_f at 30mA |
|-------------|-------------|-------------|----------------------------|--------------|----------------------------|--------------|---------------|
| | | | Minimum (lm) | Typical (lm) | Minimum (lm) | Typical (lm) | Typical |
| 5000K | MXZ7-PW50 | 70 | 10.0 | 13.0 | 18 | 23 | 2.9 |
| 5700K | MXZ7-PW57 | 70 | 10.0 | 13.0 | 18 | 23 | 2.9 |
| 6500K | MXZ7-PW65 | 70 | 10.0 | 13.0 | 18 | 23 | 2.9 |
| 2200K | MXZ8-PW22 | 80 | 8.5 | 9.7 | 14 | 17 | 2.9 |
| 2500K | MXZ8-PW25 | 80 | 8.5 | 10.2 | 14 | 17 | 2.9 |
| 2700K | MXZ8-PW27 | 80 | 8.5 | 10.5 | 15 | 18 | 2.9 |
| 3000K | MXZ8-PW30 | 80 | 8.5 | 11.0 | 15 | 20 | 2.9 |
| 3500K | MXZ8-PW35 | 80 | 9.0 | 11.0 | 16 | 20 | 2.9 |
| 4000K | MXZ8-PW40 | 80 | 10.0 | 12.0 | 18 | 22 | 2.9 |
| 5000K | MXZ8-PW50 | 80 | 10.0 | 12.0 | 18 | 22 | 2.9 |
| 5700K | MXZ8-PW57 | 80 | 9.5 | 11.5 | 17 | 20 | 2.9 |
| 6500K | MXZ8-PW65 | 80 | 9.5 | 11.5 | 17 | 20 | 2.9 |
| 2700K | MXZ9-PW27 | 90 | 8.5 | 9.0 | 14 | 17 | 2.9 |
| 3000K | MXZ9-PW30 | 90 | 8.5 | 9.3 | 14 | 17 | 2.9 |
| 4000K | MXZ9-PW40 | 90 typ. | 10.0 | 11.1 | 17 | 20 | 2.9 |
| 5000K | MXZ9-PW50 | 90 typ. | 10.0 | 11.1 | 17 | 20 | 2.9 |

Notes for Table 1:

- Lumileds maintains a tolerance of $\pm 7.5\%$ on luminous flux, ± 2 on CRI.
- Production parts are binned at 30mA, 25°C.
- Performance at 60mA, 25°C is for reference only.

Electrical Characteristics

Electrical Characteristics of Low-Power LEDs

Solder Pad Temperature = 25°C, Test Current = 30mA

Table 2.

| Part Numbers | Forward Voltage V_f ^[1] (V) | | | Typ. Temperature Coefficient of Forward Voltage ^[2] ($\text{mV}/^\circ\text{C}$) $\Delta V_f / \Delta T_j$ | Typical Thermal Resistance Junction to Solder Pad ($^\circ\text{C}/\text{W}$) $R\theta_{J-C}$ |
|--------------|--|---------|---------|--|--|
| | Minimum | Typical | Maximum | | |
| MXZx-PWXX | 2.7 | 2.9 | 3.2 | -1.6 | 45 |

Notes for Table 2:

- Lumileds maintains a tolerance of $\pm 0.10\text{V}$ on forward voltage measurements.
- Measured between $T_j = 25^\circ\text{C}$ and $T_j = 110^\circ\text{C}$.

Absolute Maximum Ratings

Table 3. Operating Condition and Ratings

| Parameter | Maximum Performance |
|--|--|
| DC Forward Current ^[1] | 90mA |
| Peak Pulsed Forward Current ^[2] | 100mA |
| Soldering Temperature | 260°C |
| Allowable Reflow Cycles | 3 |
| ESD Sensitivity | ≤ 2000V Human Body Model (HBM) Class 2 JEDEC JS-001-2012 400V Machine Model (MM) Class C JESD22-A115C |
| Storage Temperature | -40°C - 85°C |
| LED Junction Temperature | 125°C |
| Operating Case Temperature | 85°C |
| Reverse Voltage (Vr) ^{[3][4]} | -5V |

Notes for Table 3:

1. Ripple current with a frequency of 50-150 Hz is allowed, as long as the average of the current waveform is below 80mA, and the maximum of the current waveform is lower than 100mA.
2. At 10% duty cycle and pulse width 10ms.
3. LUXEON low-power LEDs are not designed to be driven in reverse bias.
4. At maximum reverse current of 10 μA.

JEDEC Moisture Sensitivity

Table 4.

| Level | Floor Life | | Soak Requirements | |
|-------|------------|-----------------|------------------------|-----------------|
| | Time | Conditions | Standard | |
| | | | Time | Conditions |
| 2 | 1 year | ≤ 30°C / 60% RH | 168 Hrs. + 5 / -0 Hrs. | ≤ 85°C / 60% RH |

Reflow Soldering Characteristics

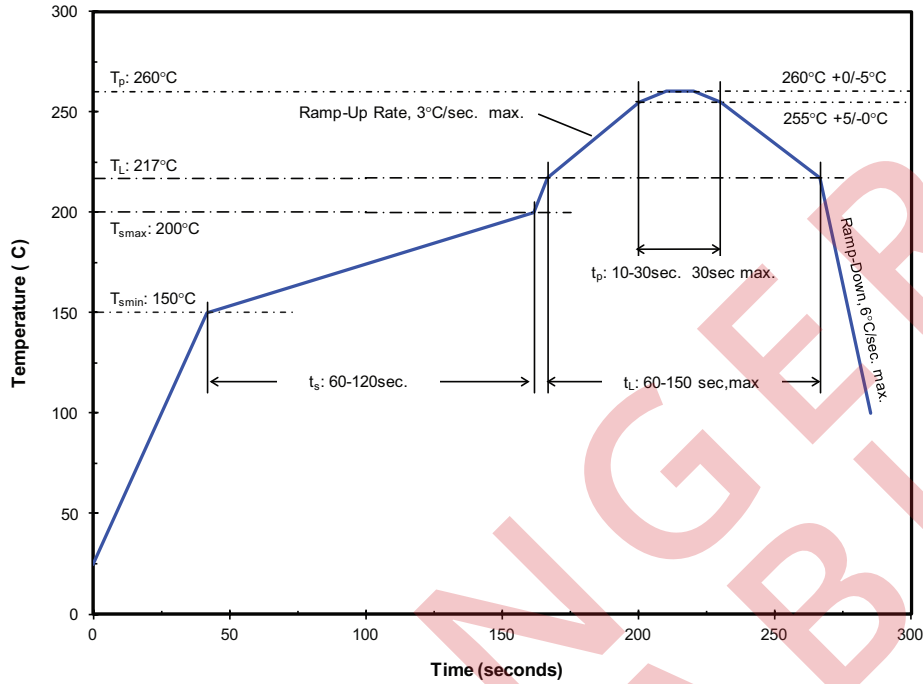

Temperature Profile for Table 5.

Table 5. Reflow Profile in Accordance with J-Std-020D.

| Profile Feature | Lead Free Assembly |
|--|--------------------|
| Preheat/Soak : | |
| Temperature Min (T_{smin}) | 150°C |
| Temperature Max (T_{smax}) | 200°C |
| Maximum Time (t_s) from T_{smin} to T_{smax} | 120 seconds |
| Ramp-up Rate (T_L to T_p) | 3°C / second |
| Liquidous Temperature (T_L) | 217°C |
| Maximum Time (t_L) Maintained above T_L | 150 seconds |
| Maximum Peak Package Body Temperature (T_p) | 260°C |
| Time (t_p) within 5°C of the specified temperature (T_c) | 10-30 seconds |
| Maximum Ramp-Down Rate (T_p to T_L) | 6°C / second |
| Maximum Time 25°C to Peak Temperature | 8 minutes |

Note for Table 5:

1. All temperatures refer to the application Printed Circuit Board (PCB), measured on the surface adjacent to the package body.

Material Information & Mechanical Dimensions

MXZx-PWxx

Table 6. Material Information

| Material/Component | Specification |
|--------------------|----------------------------------|
| Lead Frame Base: | Copper Alloy |
| Reflector Plating: | Ni/Ag |
| Electrode Plating: | Ni/Ag |
| Package Body: | High Temperature Thermal Plastic |
| Encapsulant: | Silicone Resin, with Phosphor |
| LED Chip: | InGaN |

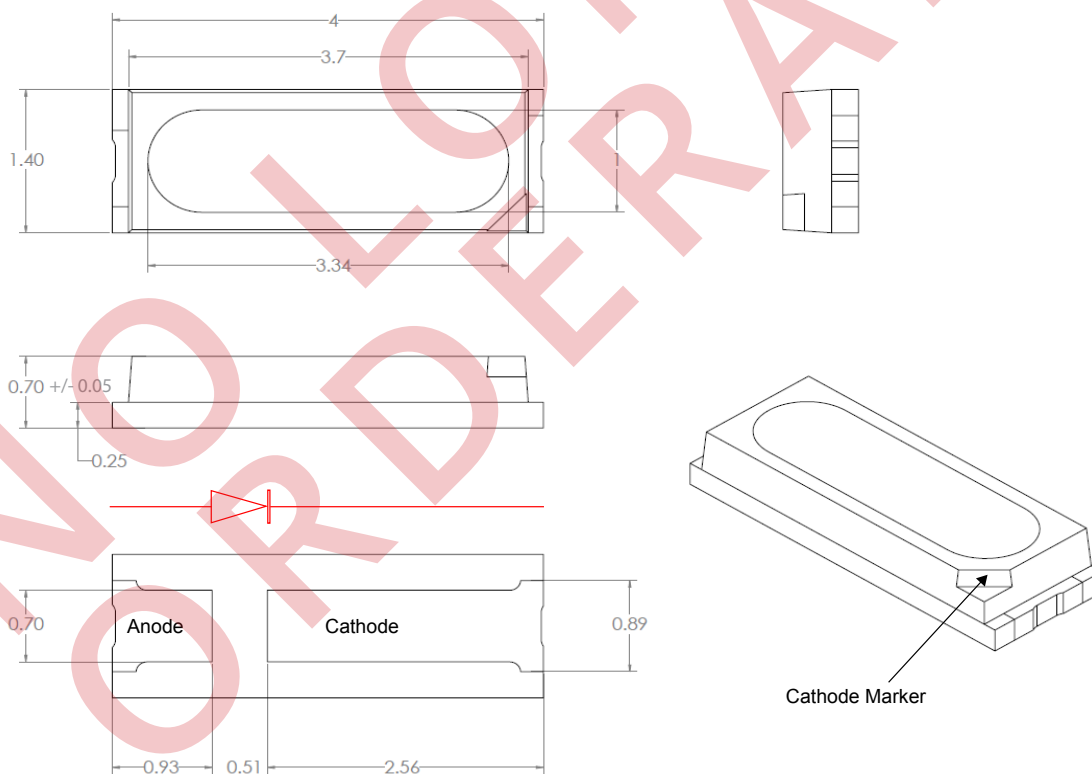

Figure 1. Package outline dimensions.

Notes for Figure 1:

1. All dimensions are in millimeters.
2. General tolerance +/- 0.10.

Characteristic Curves

Relative Spectral Distribution vs. Wavelength
Junction Temperature at 25°C; Test Current = 30mA

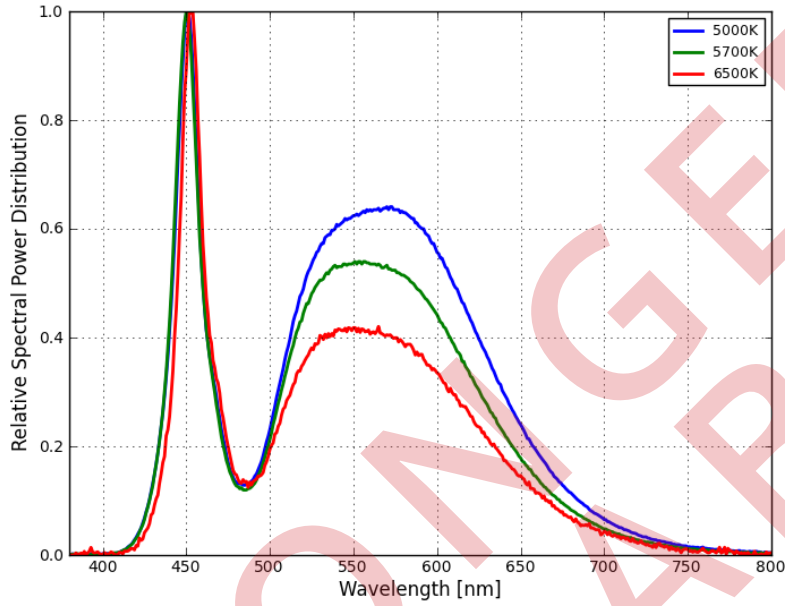

Figure 2. Emission color spectrum for MXZ7-PWxx

Relative Spectral Distribution vs. Wavelength
Junction Temperature at 25°C; Test Current = 30mA

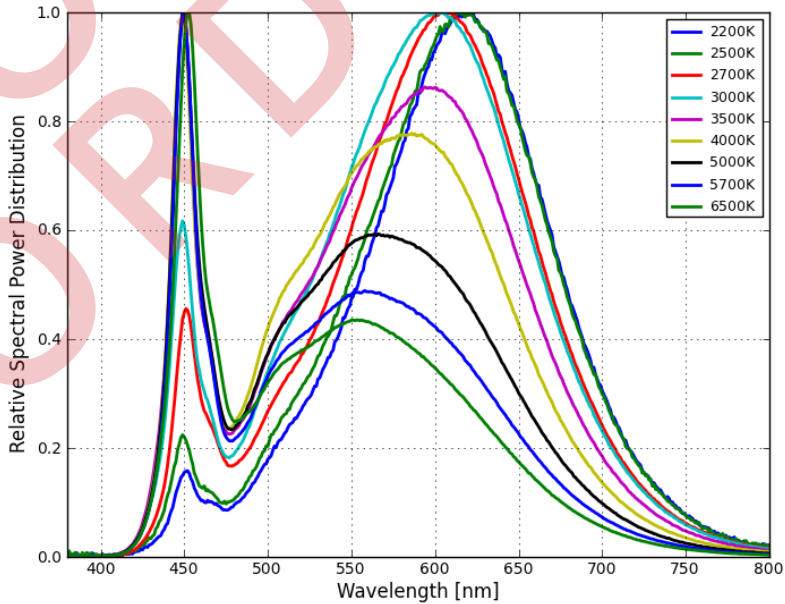

Figure 3. Emission color spectrum for MXZ8-PWxx.

Characteristic Curves, Continued

Relative Spectral Distribution vs. Wavelength
Junction Temperature at 25°C; Test Current = 30mA

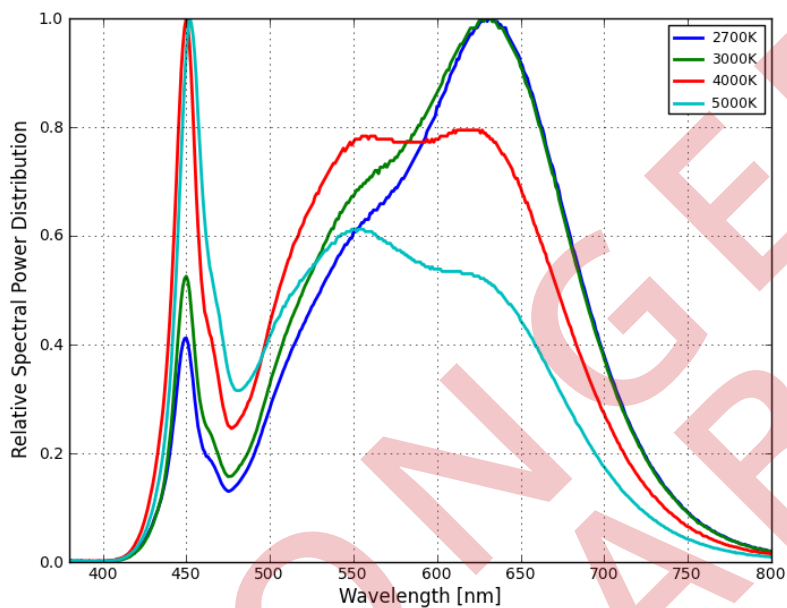

Figure 4. Emission color spectrum for MXZ9-PWxx.

Relative Light Output Characteristics over Temperature
Test Current = 30mA

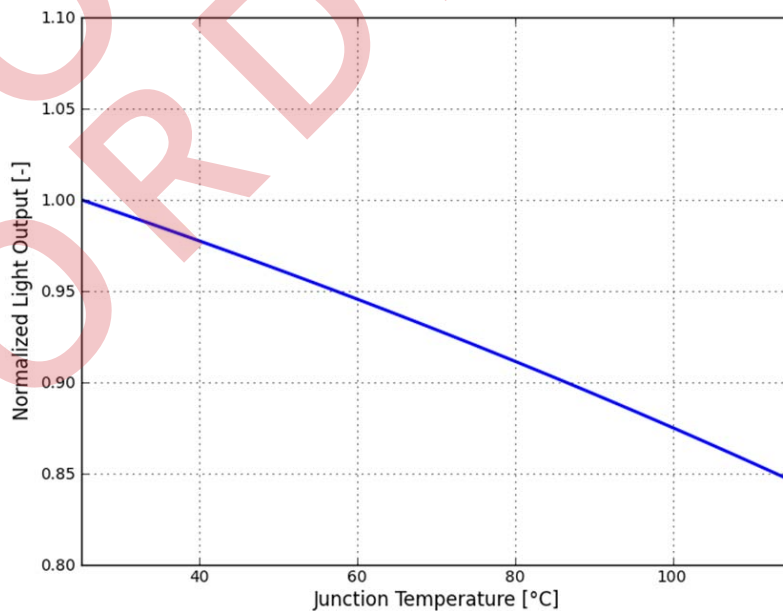

Figure 5. Relative light output vs. junction temperature for MXZx-PWxx.

Typical Forward Current

Junction Temperature at 25°C

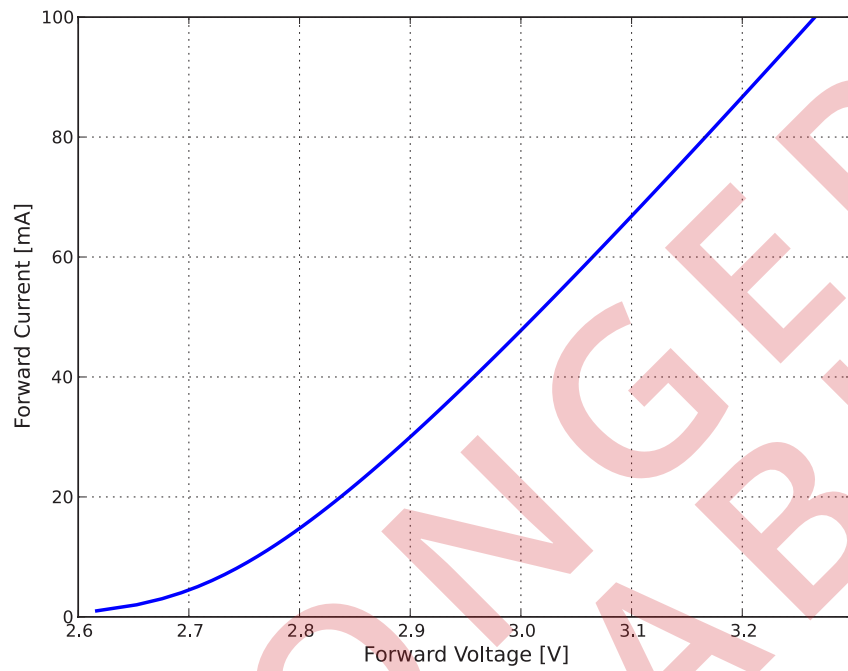

Figure 6. Forward current vs. forward voltage for MXZx-PWxx.

Light Output Characteristics

Relative Light Output Characteristics over Forward Current
Junction Temperature at 25°C

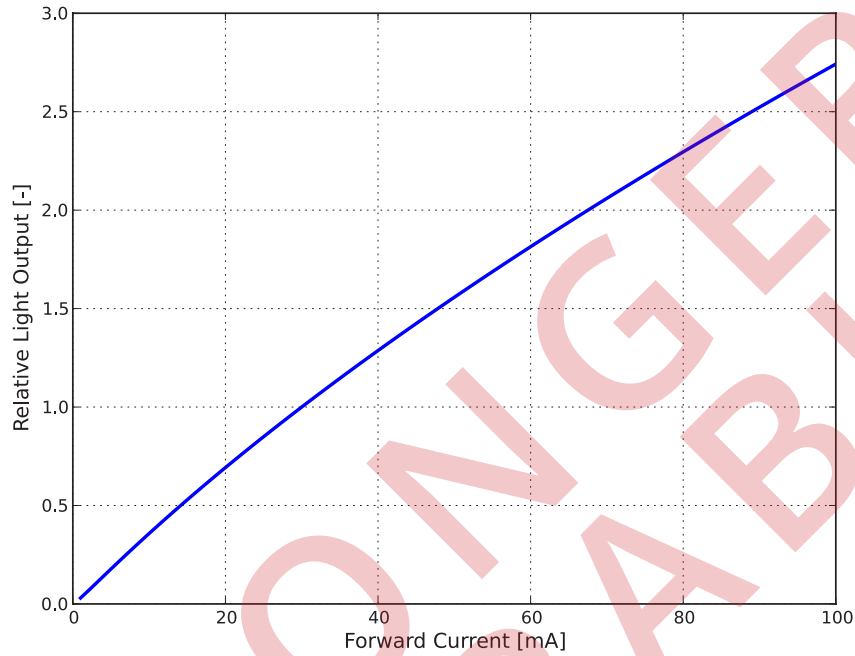

Figure 7. Light output vs. forward current for MXZx-PWxx.

Typical Relative Efficiency vs. Forward Current
Junction Temperature at 25°C

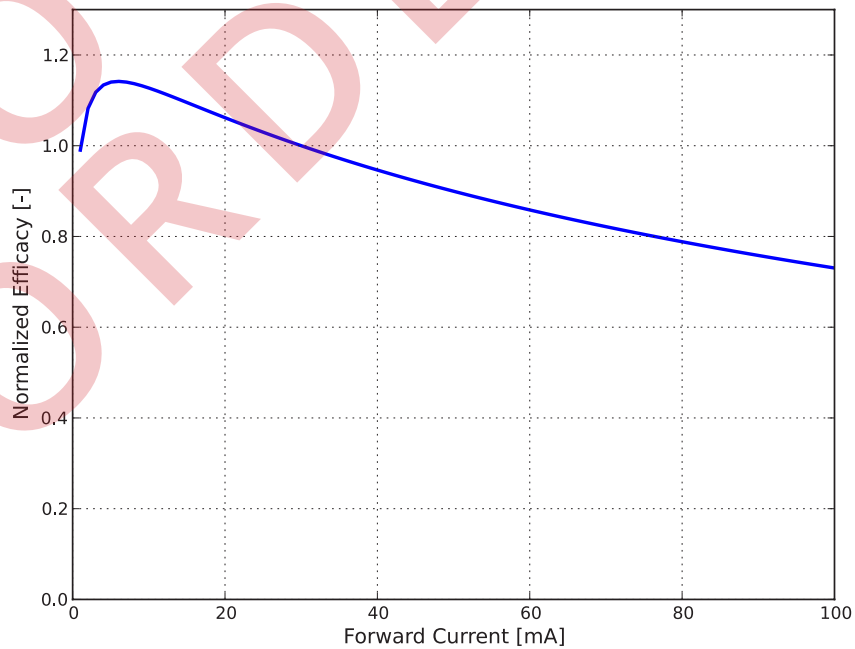

Figure 8. Typical relative efficiency vs. forward current for MXZx-PWxx.

Typical Radiation Patterns

Junction Temperature at 25°C

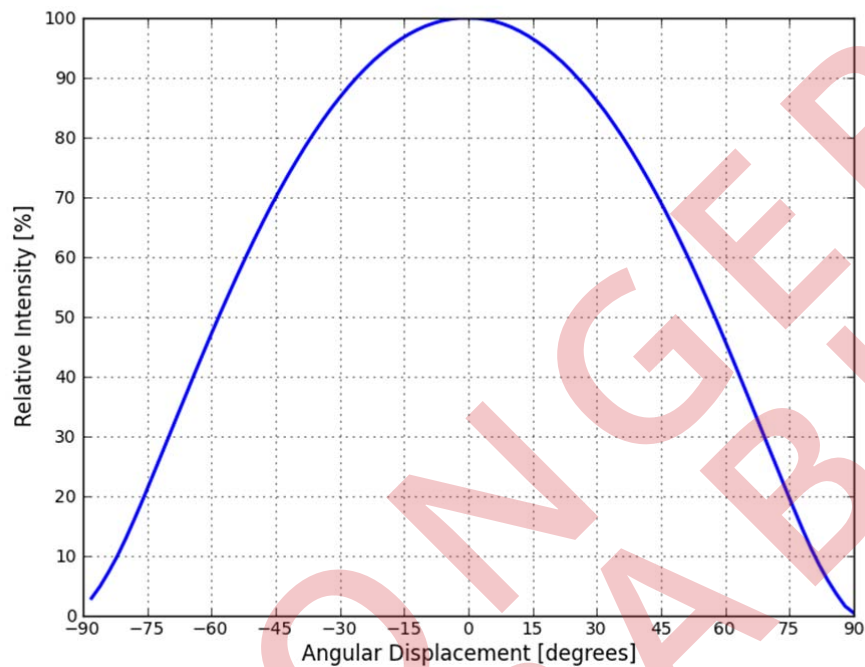

Figure 9. Radiation pattern for MXZx-PWxx.

Polar Radiation Pattern, Junction Temperature at 25°C

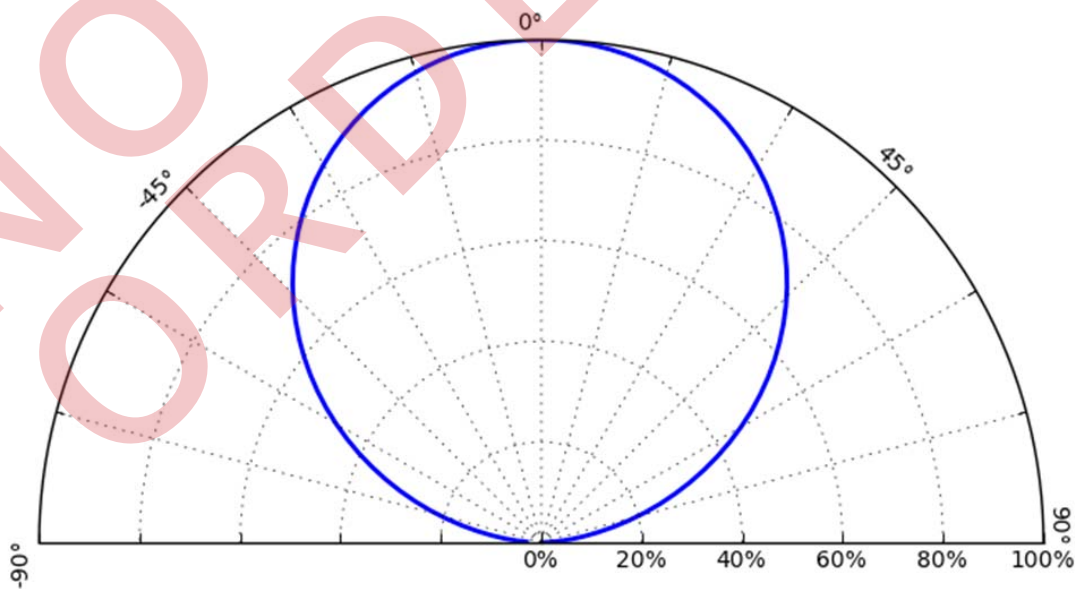

Figure 10. Radiation pattern in polar for MXZx-PWxx.

Emitter Pocket Tape Packaging

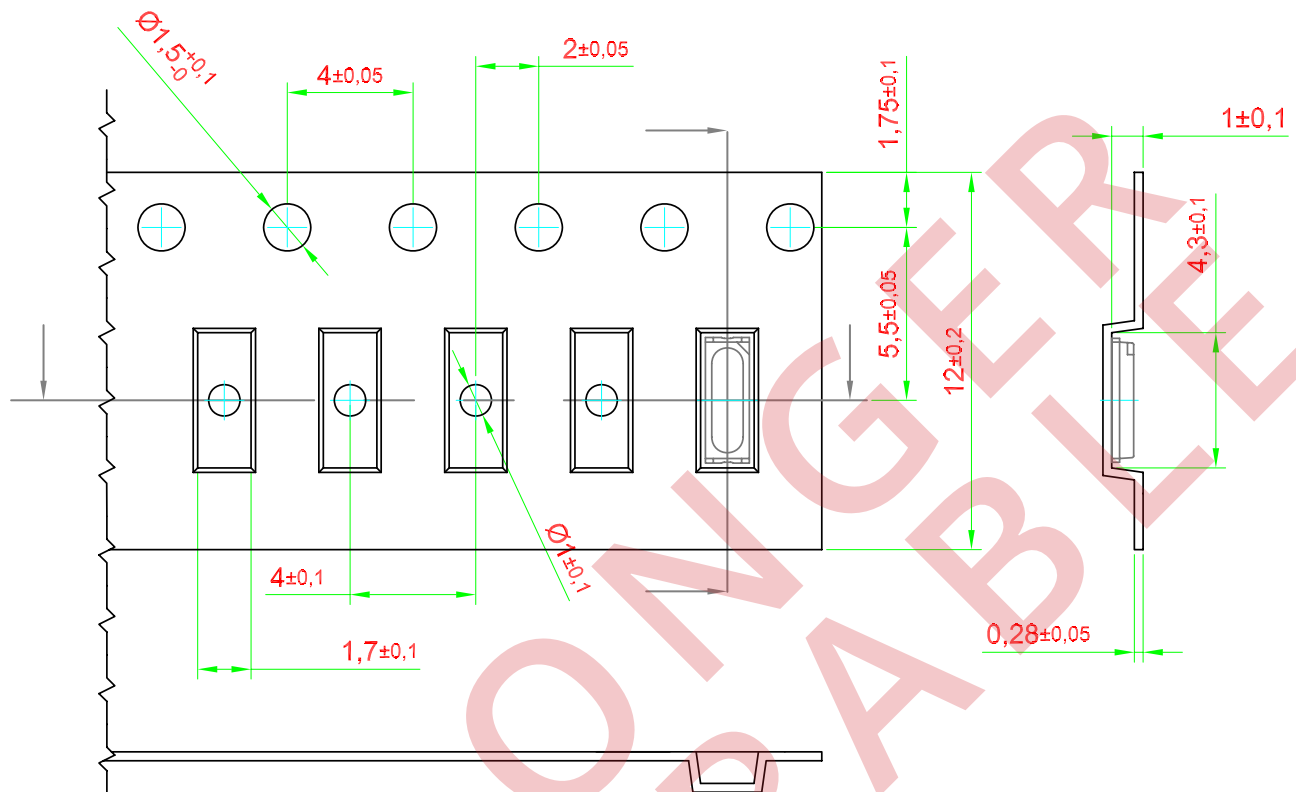

Figure 11. Emitter pocket tape packaging.

Notes for Figure 11:

1. All dimensions are in millimeters.
2. Empty component pockets sealed with top cover tape.
3. The maximum number of consecutive missing LEDs is two.

Emitter Reel Packaging

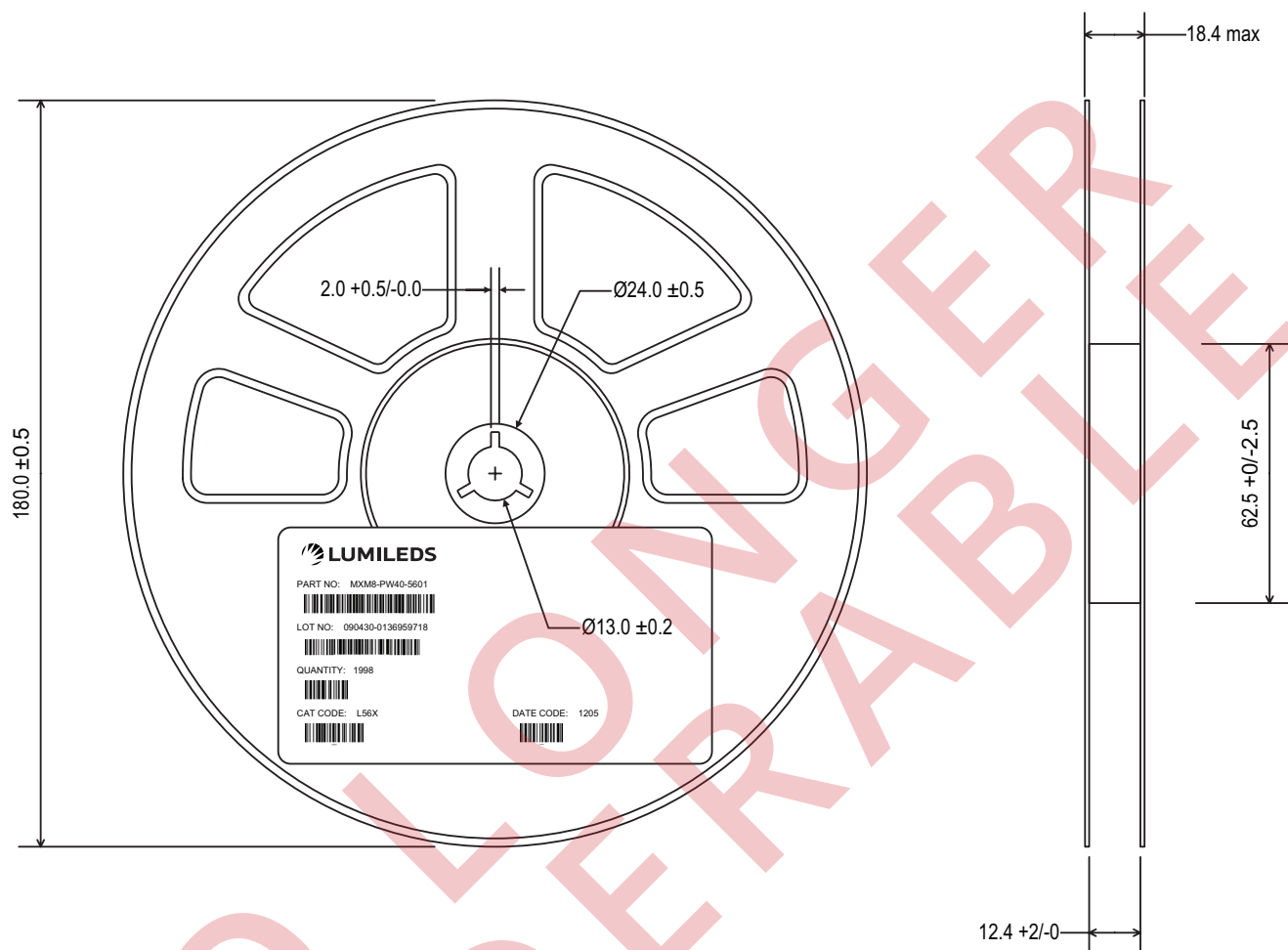

Figure 12. Emitter reel packaging.

Notes for Figure 12:

1. All dimensions are in millimeters.
2. Empty component pockets sealed with top cover tape.
3. 7 inch reel-3000 pieces per reel.
4. Minimum packing quantity is 1000 pieces.
5. The maximum number of consecutive missing LEDs is two.
6. In accordance with EIA-481-1-B specification.

Product Binning and Labeling

Purpose of Product Binning

In the manufacturing of LED products, there is a distribution of performance around the typical values given in the technical data sheets. For this reason, Lumileds bins the LED components for luminous flux, color and forward voltage (V_f).

Decoding Product Bin Labeling

LUXEON 4014 emitters are labeled using a four digit alphanumeric code (CAT code) depicting the bin values for emitters packaged on a single reel. All emitters packaged within a reel are of the same 3-variable bin combination. Using these codes, it is possible to determine optimum mixing and matching of products for consistency in a given application.

Reels of 2700K, 3000K, 3500K, 4000K, 5000K, 6500K emitters are labeled with a four digit alphanumeric CAT code following the format below.

ABCD

A = Flux bin (L etc.)

B and C = Color bin (For example 93, A1, 5L or 5M)

D = V_f bin

Luminous Flux and Forward Voltage Bins

Tables 7 and 8 list the standard photometric luminous flux bins for LUXEON 4014 emitters (tested and binned at 30mA). Although several bins are outlined, product availability in a particular bin varies by production run and by product performance. Not all bins are available in all colors.

Table 7. Flux Bins

| Bin Code | Minimum Photometric Flux (lm) | Maximum Photometric Flux (lm) |
|----------|-------------------------------|-------------------------------|
| A | 8.5 | 10.0 |
| B | 10.0 | 11.5 |
| C | 11.5 | 13.0 |
| D | 13.0 | 15.0 |
| E | 15.0 | 18.0 |

Tested and binned at 25°C, $I_f=30\text{mA}$. Tester tolerance: $\pm 7.5\%$.

Table 8. V_f Bins

| Bin Code | Minimum Forward Voltage (V) | Maximum Forward Voltage (V) |
|----------|-----------------------------|-----------------------------|
| S | 2.7 | 2.8 |
| T | 2.8 | 2.9 |
| V | 2.9 | 3.0 |
| W | 3.0 | 3.1 |
| X | 3.1 | 3.2 |

Tested and binned at 25°C, $I_f=30\text{mA}$. Tester tolerance: $\pm 0.10\text{V}$.

Color Bin Structure

MXZ8-PW22 1/6th Color Bin Structure

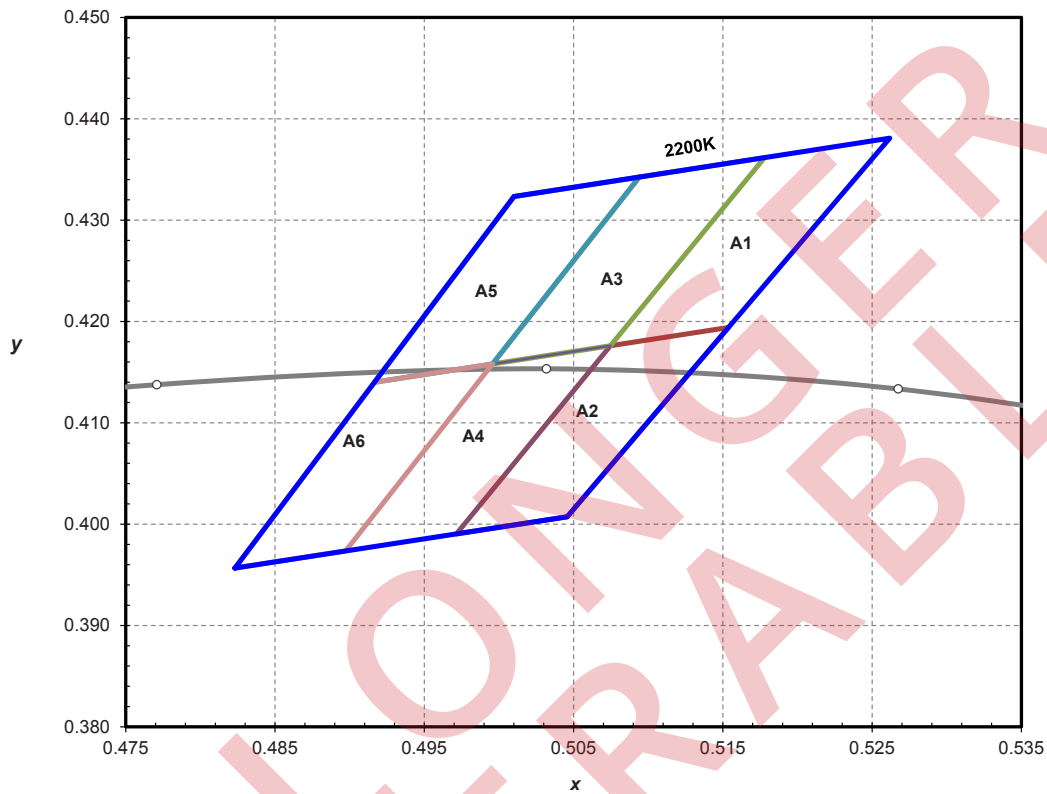

Figure 13. 2200K 1/6th ANSI color bin structure.

LUXEON 4014 emitters are tested and binned by x,y coordinates.

Table 9.

| LUXEON 4014 1/6 th ANSI Color Bin Coordinates for MXZ8-PW22-0000 Emitter | | | | | |
|---|--------|--------|----------|--------|--------|
| Bin Code | x | y | Bin Code | x | y |
| A1 | 0.5178 | 0.4362 | A4 | 0.4996 | 0.4158 |
| | 0.5262 | 0.4381 | | 0.5075 | 0.4176 |
| | 0.5154 | 0.4194 | | 0.4972 | 0.3990 |
| | 0.5075 | 0.4176 | | 0.4897 | 0.3974 |
| A2 | 0.5075 | 0.4176 | A5 | 0.5010 | 0.4323 |
| | 0.5154 | 0.4194 | | 0.5094 | 0.4343 |
| | 0.5046 | 0.4007 | | 0.4996 | 0.4158 |
| | 0.4972 | 0.3990 | | 0.4917 | 0.4140 |
| A3 | 0.5094 | 0.4343 | A6 | 0.4917 | 0.4140 |
| | 0.5178 | 0.4362 | | 0.4996 | 0.4158 |
| | 0.5075 | 0.4176 | | 0.4897 | 0.3974 |
| | 0.4996 | 0.4158 | | 0.4823 | 0.3957 |

Notes for Figure 13 and Table 9:

1. Tested and binned at 25°C, I_f=30mA. Tester tolerance: ± 0.01 in x and y coordinates.

Color Bin Structure

MXZ8-PW25 1/6th Color Bin Structure

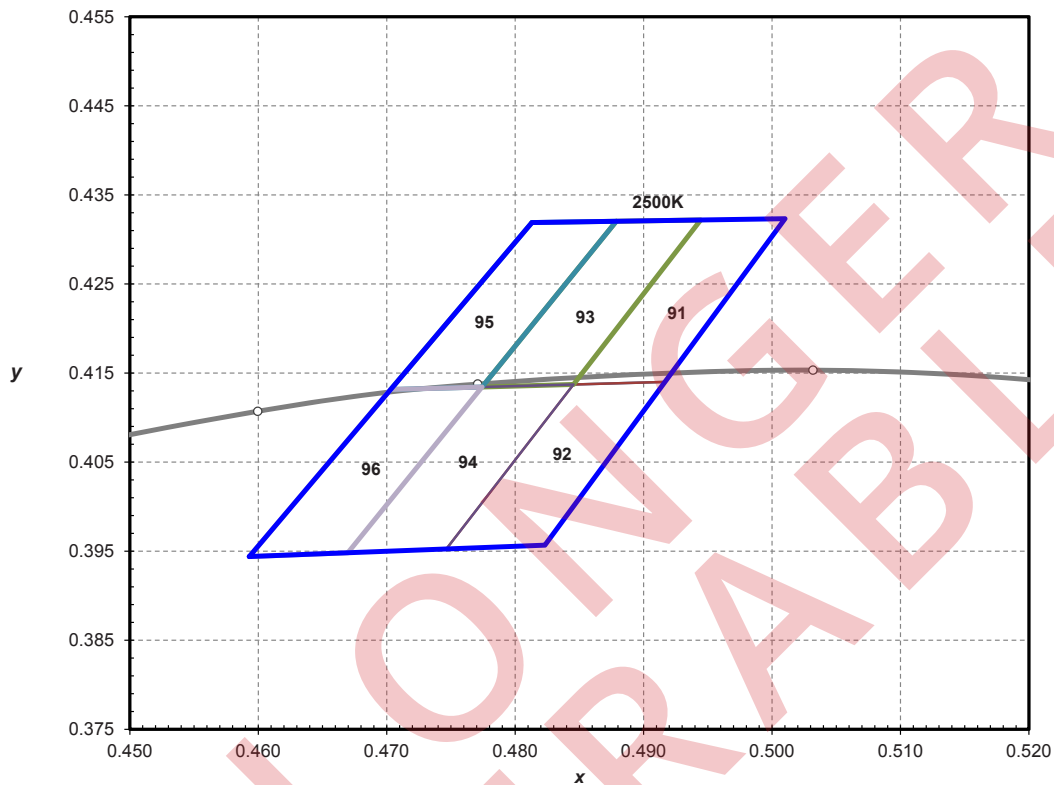

Figure 14. 2500K 1/6th ANSI color bin structure.

LUXEON 4014 emitters are tested and binned by x,y coordinates.

Table 10.

| LUXEON 4014 1/6 th ANSI Color Bin Coordinates for MXZ8-PW25-0000 Emitter | | | | | |
|---|--------|--------|----------|--------|--------|
| Bin Code | x | y | Bin Code | x | y |
| 91 | 0.4944 | 0.4322 | 94 | 0.4774 | 0.4134 |
| | 0.5010 | 0.4323 | | 0.4845 | 0.4137 |
| | 0.4917 | 0.4140 | | 0.4746 | 0.3952 |
| | 0.4845 | 0.4137 | | 0.4670 | 0.3948 |
| 92 | 0.4845 | 0.4137 | 95 | 0.4813 | 0.4319 |
| | 0.4917 | 0.4140 | | 0.4879 | 0.4320 |
| | 0.4823 | 0.3957 | | 0.4774 | 0.4134 |
| | 0.4746 | 0.3952 | | 0.4703 | 0.4132 |
| 93 | 0.4879 | 0.4320 | 96 | 0.4703 | 0.4132 |
| | 0.4944 | 0.4322 | | 0.4774 | 0.4134 |
| | 0.4845 | 0.4137 | | 0.4670 | 0.3948 |
| | 0.4774 | 0.4134 | | 0.4593 | 0.3944 |

Notes for Figure 14 and Table 10:

1. Tested and binned at 25°C, I_f=30mA. Tester tolerance: ± 0.01 in x and y coordinates.

Color Bin Structure

MXZx-PW27 1/9th Color Bin Structure

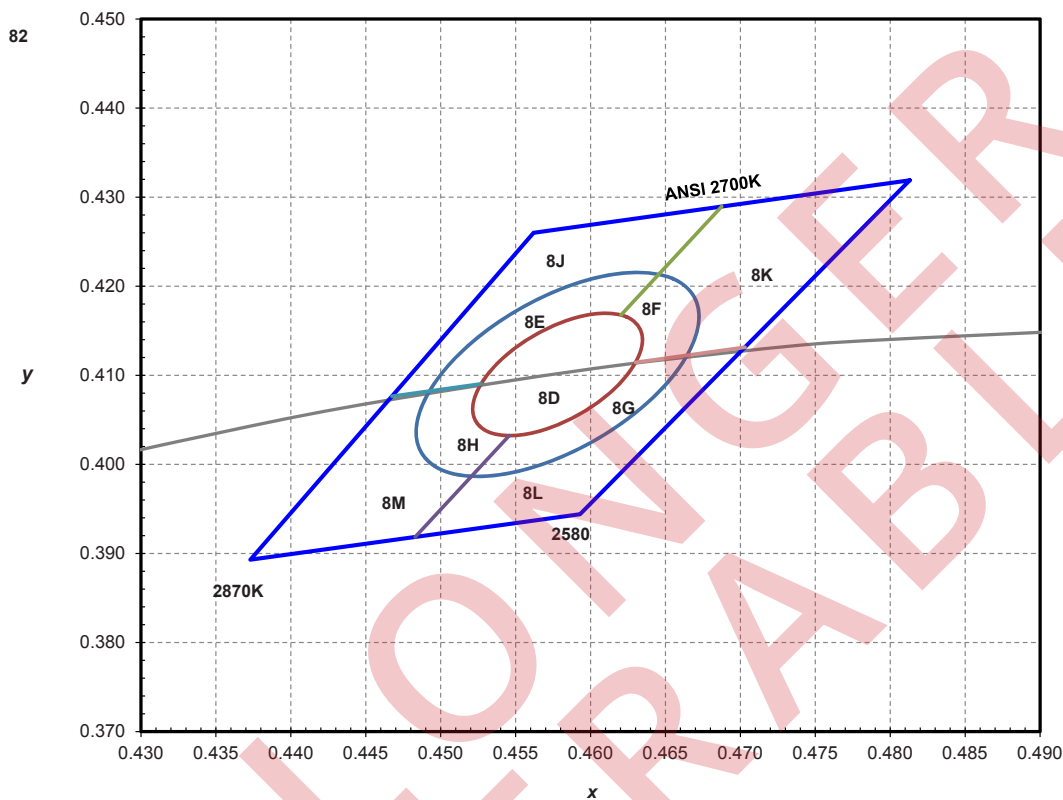

Figure 15. 2700K 1/9th ANSI color bin structure.

LUXEON 4014 emitters are tested and binned by x,y coordinates.

Table 11.

| Nominal ANSI CCT | Color Space | Center Point (cx, cy) | Major Axis, a | Minor Axis, b | Ellipse Rotation Angle (degrees) |
|------------------|-------------------------------|-----------------------|---------------|---------------|----------------------------------|
| 2700K | Single 3-step MacAdam ellipse | (0.4578, 0.4101) | 0.00810 | 0.00420 | 53.70 |
| 2700K | Single 5-step MacAdam ellipse | (0.4578, 0.4101) | 0.01350 | 0.00700 | 53.70 |

Notes for Figure 15 and Table 11:

1. Tested and binned at 25°C, I_f=30mA. Tester tolerance: ± 0.01 in x and y coordinates.

Color Bin Structure

MXZx-PW30 1/9th Color Bin Structure

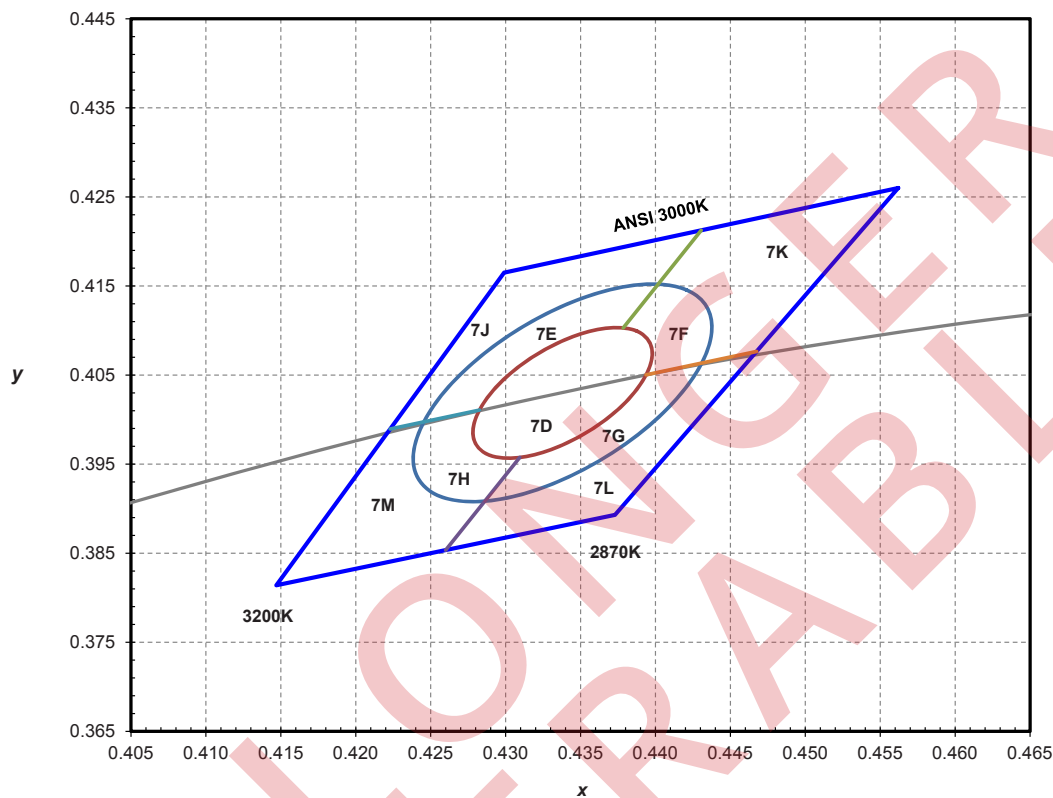

Figure 16. 3000K 1/9th ANSI color bin structure.

LUXEON 4014 emitters are tested and binned by x,y coordinates.

Table 12.

| Nominal ANSI CCT | Color Space | Center Point (cx, cy) | Major Axis, a | Minor Axis, b | Ellipse Rotation Angle (degrees) |
|------------------|-------------------------------|-----------------------|---------------|---------------|----------------------------------|
| 3000K | Single 3-step MacAdam ellipse | (0.4338, 0.403) | 0.00834 | 0.00408 | 53.22 |
| 3000K | Single 5-step MacAdam ellipse | (0.4338, 0.403) | 0.01390 | 0.00680 | 53.22 |

Notes for Figure 16 and Table 12:

1. Tested and binned at 25°C, I_f=30mA. Tester tolerance: ± 0.01 in x and y coordinates.

Color Bin Structure

MXZx-PW35 1/9th Color Bin Structure

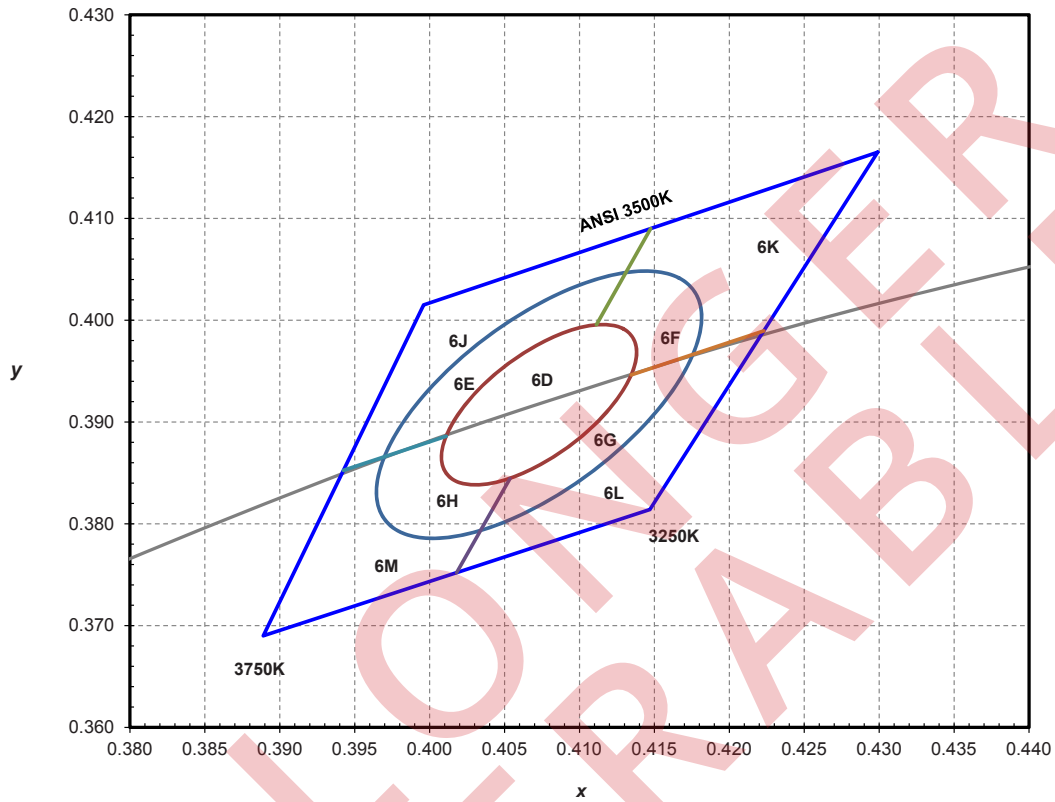

Figure 17. 3500K 1/9th ANSI color bin structure.

LUXEON 4014 emitters are tested and binned by x,y coordinates.

Table 13.

| Nominal ANSI CCT | Color Space | Center Point (cx, cy) | Major Axis, a | Minor Axis, b | Ellipse Rotation Angle (degrees) |
|------------------|-------------------------------|-----------------------|---------------|---------------|----------------------------------|
| 3500K | Single 3-step MacAdam ellipse | (0.4073, 0.3917) | 0.00927 | 0.00414 | 54.00 |
| 3500K | Single 5-step MacAdam ellipse | (0.4073, 0.3917) | 0.01545 | 0.00690 | 54.00 |

Notes for Figure 17 and Table 13:

1. Tested and binned at 25°C, I_f=30mA. Tester tolerance: ± 0.01 in x and y coordinates.

Color Bin Structure

MXZx-PW40 1/9th Color Bin Structure

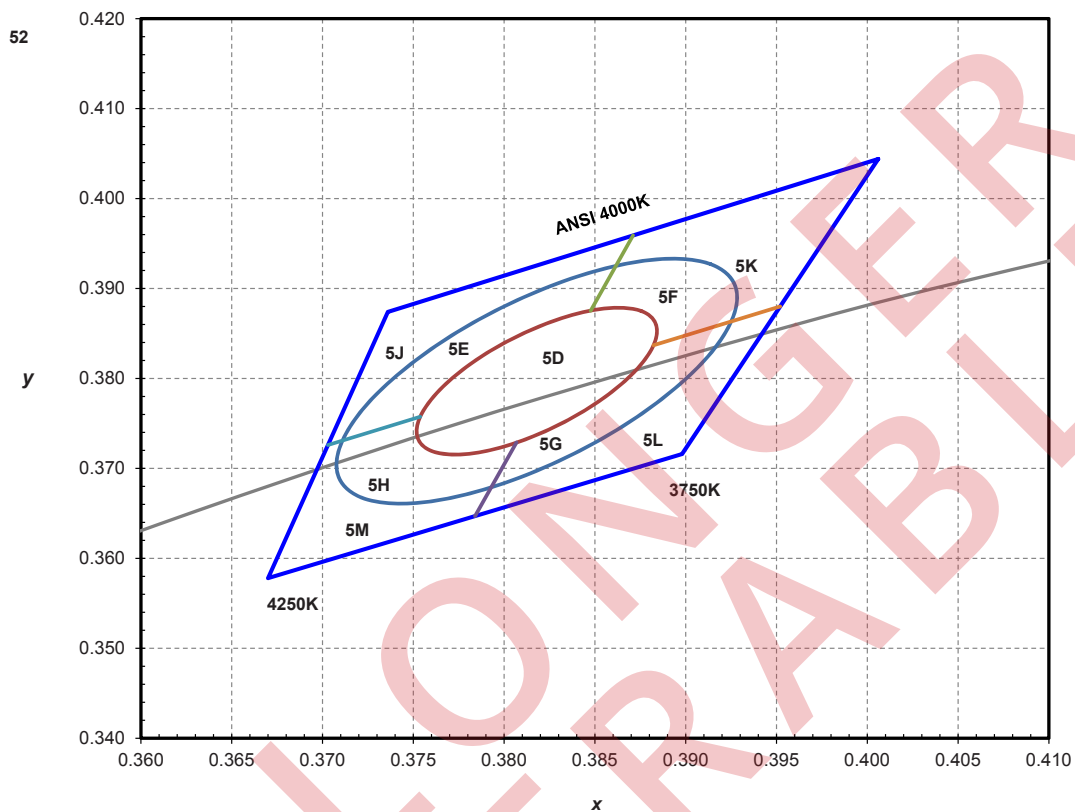

Figure 18. 4000K 1/9th ANSI color bin structure.

LUXEON 4014 emitters are tested and binned by x,y coordinates.

Table 14.

| Nominal ANSI CCT | Color Space | Center Point (cx, cy) | Major Axis, a | Minor Axis, b | Ellipse Rotation Angle (degrees) |
|------------------|-------------------------------|-----------------------|---------------|---------------|----------------------------------|
| 4000K | Single 3-step MacAdam ellipse | (0.3818, 0.3797) | 0.00939 | 0.00402 | 53.72 |
| 4000K | Single 5-step MacAdam ellipse | (0.3818, 0.3797) | 0.01565 | 0.00670 | 53.72 |

Notes for Figure 18 and Table 14:

1. Tested and binned at 25°C, I_f=30mA. Tester tolerance: ± 0.01 in x and y coordinates.

Color Bin Structure

MXZx-PW50 1/9th Color Bin Structure

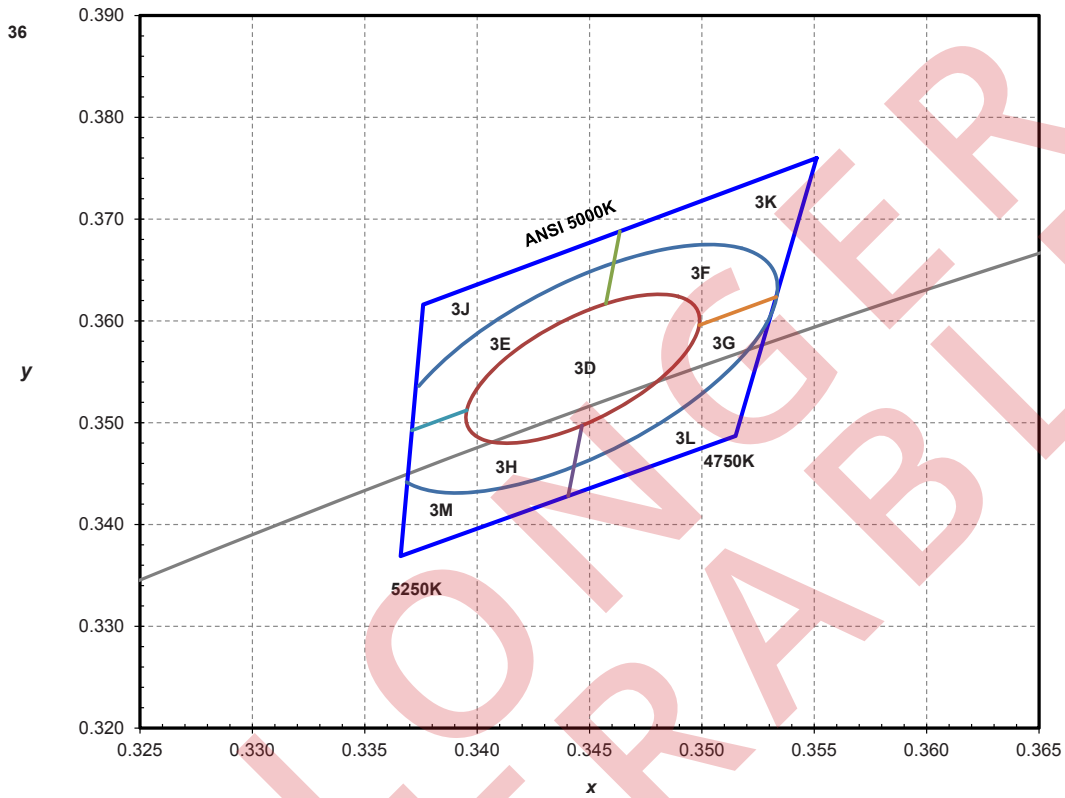

Figure 19. 5000K 1/9th ANSI color bin structure.

LUXEON 4014 emitters are tested and binned by x,y coordinates.

Table 15.

| Nominal ANSI CCT | Color Space | Center Point (cx, cy) | Major Axis, a | Minor Axis, b | Ellipse Rotation Angle (degrees) |
|------------------|-------------------------------|-----------------------|---------------|---------------|----------------------------------|
| 5000K | Single 3-step MacAdam ellipse | (0.3447, 0.3553) | 0.00822 | 0.00354 | 59.62 |
| 5000K | Single 5-step MacAdam ellipse | (0.3447, 0.3553) | 0.01370 | 0.00590 | 59.62 |

Notes for Figure 19 and Table 15:

1. Tested and binned at 25°C, I_f=30mA. Tester tolerance: ± 0.01 in x and y coordinates.

Color Bin Structure

MXZx-PW57 1/9th Color Bin Structure

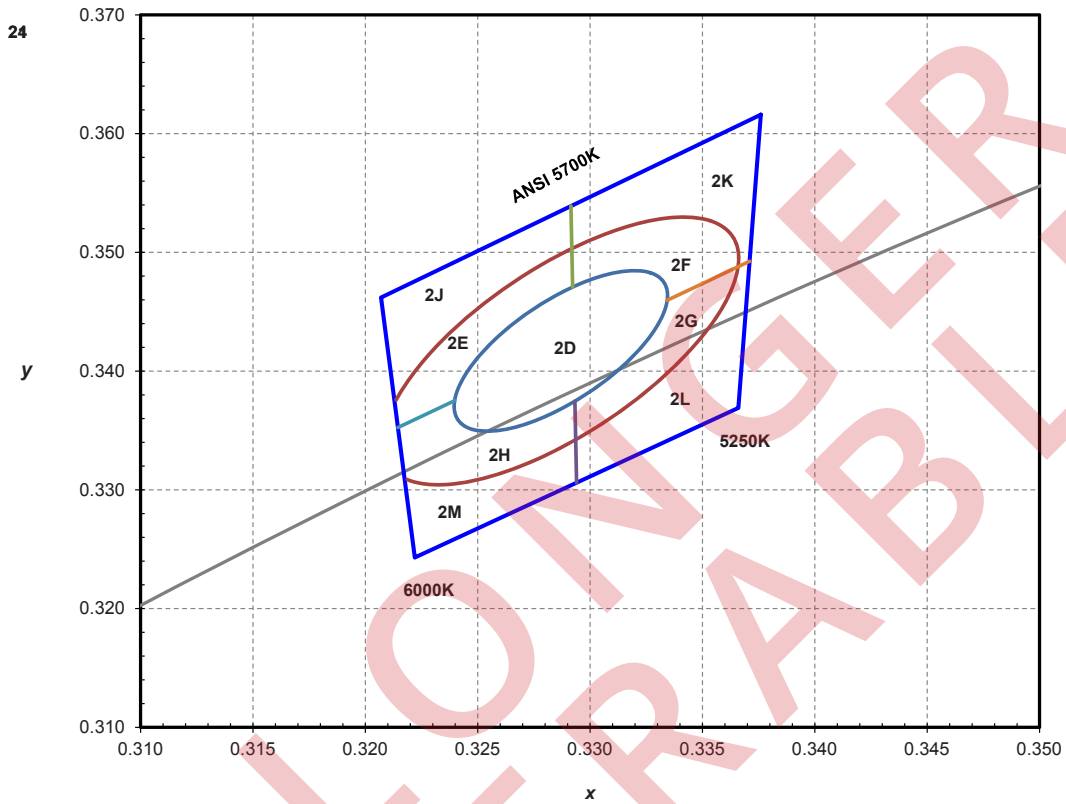

Figure 20. 5700K ANSI 1/9th color bin structure.

LUXEON 4014 emitters are tested and binned by x,y coordinates.

Table 16.

| Nominal ANSI CCT | Color Space | Center Point (cx, cy) | Major Axis, a | Minor Axis, b | Ellipse Rotation Angle (degrees) |
|------------------|-------------------------------|-----------------------|---------------|---------------|----------------------------------|
| 5700K | Single 3-step MacAdam ellipse | (0.3287, 0.3417) | 0.00746 | 0.00320 | 59.09 |
| 5700K | Single 5-step MacAdam ellipse | (0.3287, 0.3417) | 0.01243 | 0.00533 | 59.09 |

Notes for Figure 20 and Table 16:

1. Tested and binned at 25°C, I_f=30mA. Tester tolerance: ± 0.01 in x and y coordinates.

Color Bin Structure

MXZx-PW65 1/9th ColorBin Structure

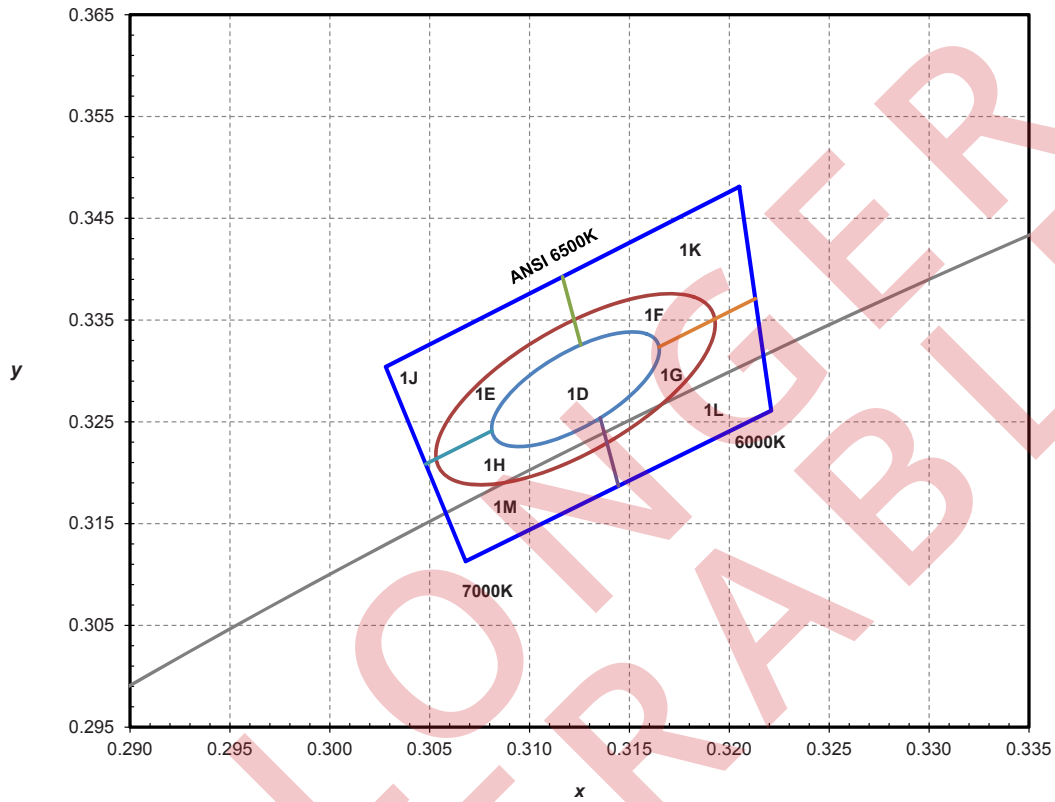

Figure 21. 6500K 1/9th ANSI color bin structure.

LUXEON 4014 emitters are tested and binned by x,y coordinates.

Table 17.

| Nominal ANSI CCT | Color Space | Center Point (cx, cy) | Major Axis, a | Minor Axis, b | Ellipse Rotation Angle (degrees) |
|------------------|-------------------------------|-----------------------|---------------|---------------|----------------------------------|
| 6500K | Single 3-step MacAdam ellipse | (0.3123, 0.3282) | 0.00669 | 0.00285 | 58.57 |
| 6500K | Single 5-step MacAdam ellipse | (0.3123, 0.3282) | 0.01115 | 0.00475 | 58.57 |

Notes for Figure 21 and Table 17:

1. Tested and binned at 25°C, I_f=30mA. Tester tolerance: ± 0.01 in x and y coordinates.

About Lumileds

Lumileds is the global leader in light engine technology. The company develops, manufactures and distributes groundbreaking LEDs and automotive lighting products that shatter the status quo and help customers gain and maintain a competitive edge.

With a rich history of industry “firsts,” Lumileds is uniquely positioned to deliver lighting advancements well into the future by maintaining an unwavering focus on quality, innovation and reliability.

To learn more about our portfolio of light engines visit lumileds.com.

NO LONGER AVAILABLE



©2016 Lumileds Holding B.V. All rights reserved.
LUXEON is a registered trademark of the Lumileds Holding B.V.
in the United States and other countries.

lumileds.com

Neither Lumileds Holding B.V. nor its affiliates shall be liable for any kind of loss of data or any other damages, direct, indirect or consequential, resulting from the use of the provided information and data. Although Lumileds Holding B.V. and/or its affiliates have attempted to provide the most accurate information and data, the materials and services information and data are provided “as is,” and neither Lumileds Holding B.V. nor its affiliates warrants or guarantees the contents and correctness of the provided information and data. Lumileds Holding B.V. and its affiliates reserve the right to make changes without notice. You as user agree to this disclaimer and user agreement with the download or use of the provided materials, information and data.