

### Features

- LO 2.5 TO 11.5 GHz
- RF 4.5 TO 9.5 GHz
- IF DC TO 2.0 GHz
- LO DRIVE: +10 dBm (NOMINAL)
- LOW NOISE FIGURE 5.5 dB (TYP.)

### Description

The MY76 is a double balanced mixer, designed for use in military, commercial and test equipment applications. The design utilizes Schottky ring quad diodes and broadband soft dielectric and ferrite baluns to attain excellent performance. This mixer can also be used as a phase detector and/or bi-phase modulator since the IF port is DC coupled to the diodes. The use of high temperature solder and welded assembly processes used internally makes it ideal for use in manual, semi-automated assembly. Environmental screening available to MIL-STD-883, MIL-STD-202, or MIL-DTL-28837, consult factory.

### Product Image

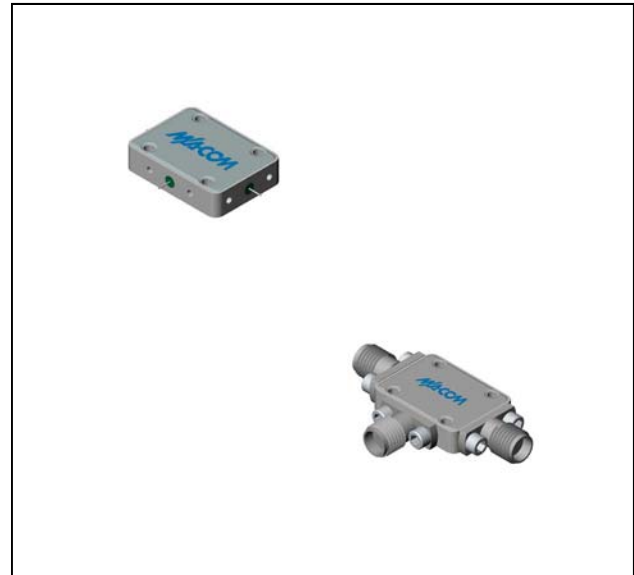

### Ordering Information

Part Number	Package
MY76	Versapac
MY76C	SMA Connectorized

### Electrical Specifications: $Z_0 = 50\Omega$ $L_o = +10$ dBm (Downconverter application only)

Parameter	Test Conditions	Units	Typical	Guaranteed	
				+25°C	-54° to +85°C
SSB Conversion Loss (max) & SSB Noise Figure (max)	fR = 6 to 8 GHz, fL = 4 to 9 GHz, fI = 0.03 to 2 GHz fR = 5 to 9 GHz, fL = 4 to 9 GHz, fI = 0.03 to 1 GHz fR = 4.5 to 9.5 GHz, fL = 2.5 to 11.5 GHz, fI = 0.03 to 2 GHz	dB	5.5	7.0	7.5
			5.5	7.0	7.5
			6.0	8.0	8.5
Isolation, L to R (min)	fL = 2.5 to 9 GHz fL = 9 to 11.5 GHz	dB	40	25	23
			30	20	18
Isolation, L to I (min)	fL = 4 to 11.5 GHz fL = 2.5 to 4 GHz	dB	25	15	13
			20	10	8
1 dB Conversion Comp.	fL = +10 dBm	dBm	+3		
Input IP3	fR1 = 7 GHz at -6 dBm, fR2 = 7.01 GHz at -6 dBm, fL = 8 GHz at +10 dBm	dBm	+13		

### Typical Performance Curves

**Conversion Loss Vs. LO Drive**

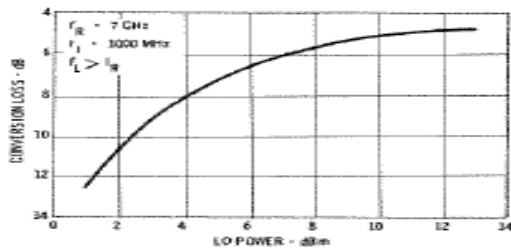

**Conversion Loss vs. RF Input Power**

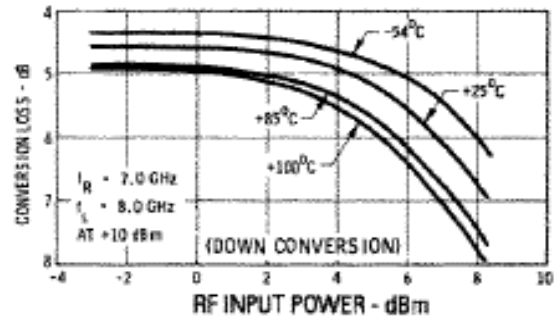

**Conversion Loss vs. Frequency**

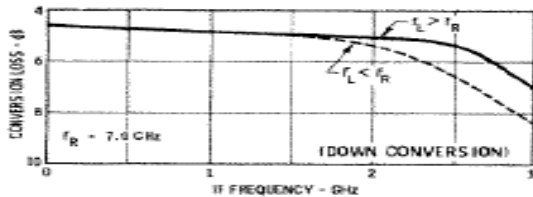
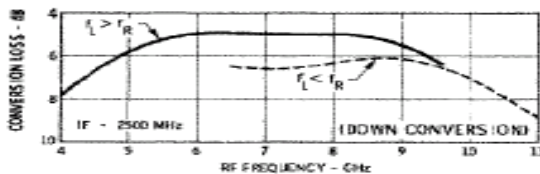
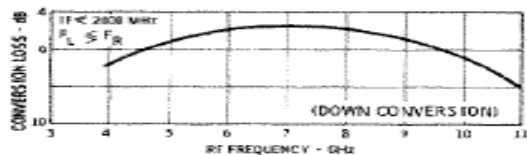

**Isolation vs. Frequency**

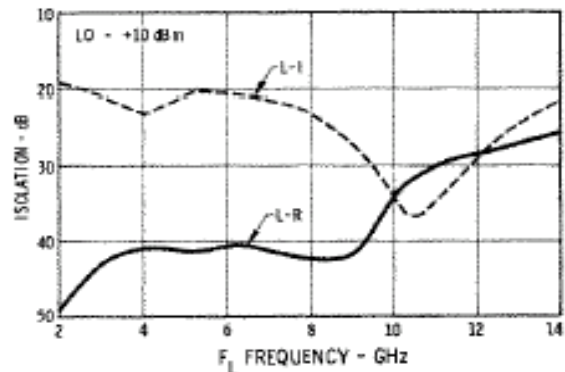

**Conversion Loss vs. Output Frequency**

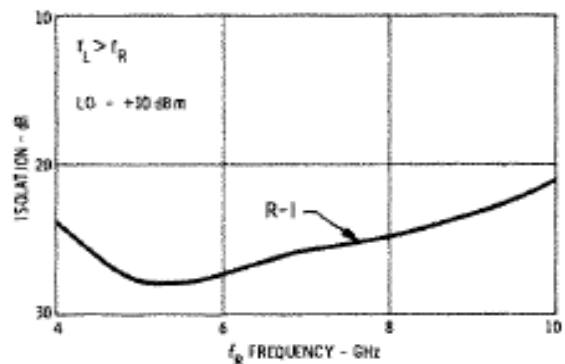
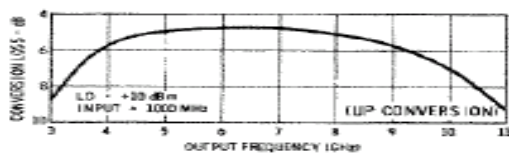

### Absolute Maximum Ratings

Parameter	Absolute Maximum
Operating Temperature	-54°C to +100°C
Storage Temperature	-65°C to +100°C
Peak Input Power	+23 dBm max @ +25°C +20 dBm max @ +100°C
Peak Input Current	100 mA DC

### R-Port VSWR vs. Frequency

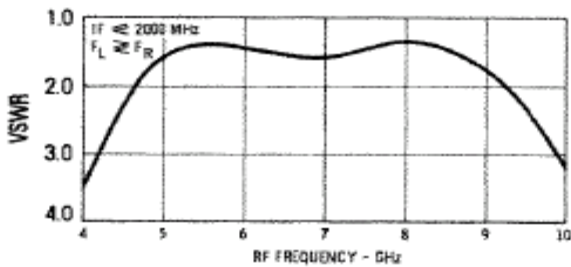

### I-Port VSWR vs. f<sub>L</sub>

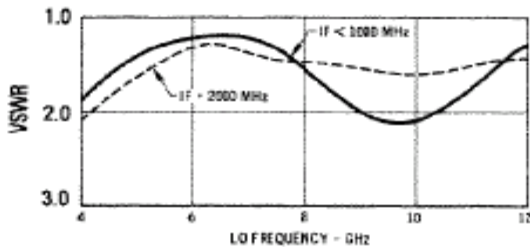

### L-Port VSWR vs. Frequency

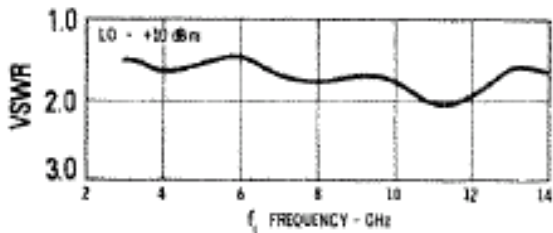

### Outline Drawing: Versapac \*

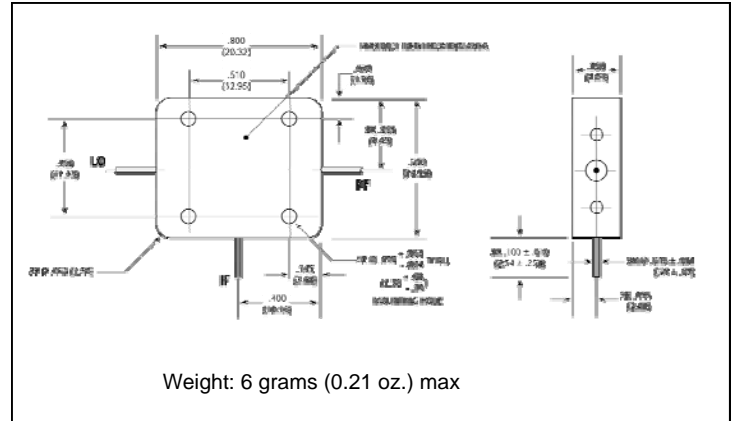

### Outline Drawing: SMA Connectorized \*

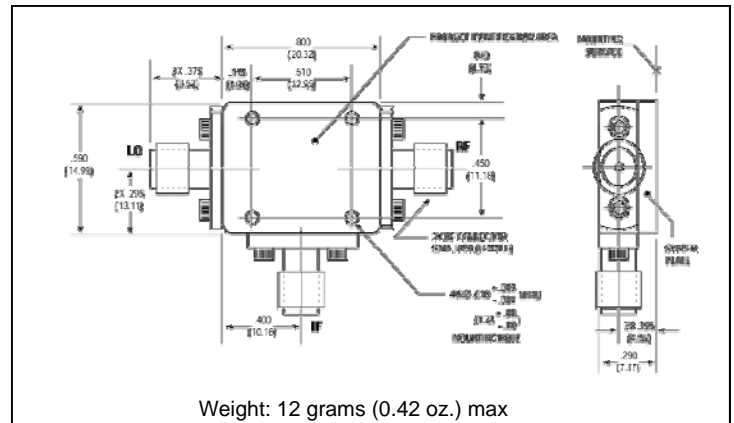

\* Dimensions are inches (millimeters) ±0.015 (0.38) unless otherwise specified.