

## Low Cost High IP3 Mixer for PCS/WLL Applications

Rev. V3

### Features

- LO & RF 10 TO 2800 MHz
- IF 10 TO 2000 MHz
- LO DRIVE +10 dBm (NOMINAL)
- SURFACE MOUNT
- HIGH INTERCEPT +20 dBm (TYP.)
- +260°C REFLOW COMPATIBLE

### Description

The CSM2-10 is a double balanced mixer, designed for use in the high volume wireless applications. The design utilizes Schottky ring quad diodes and broadband baluns to attain excellent performance.

### Product Image

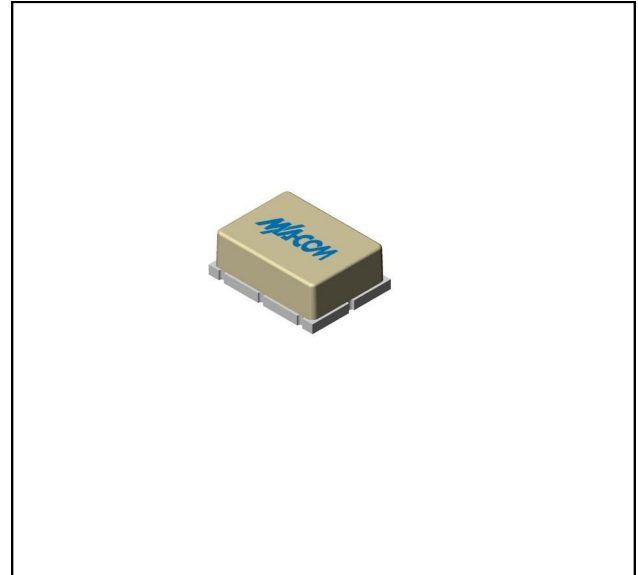

### Ordering Information

Part Number	Package
CSM2-10	Surface Mount

### Electrical Specifications: $Z_0 = 50\Omega$ $Lo = +10$ dBm (Downconverter application only)

Parameter	Test Conditions	Units	Typical	Guaranteed	
				+25°C	-40° to +85°C
SSB Conversion Loss(max)	fR = 10 to 1200 MHz, fL = 10 to 1200 MHz, fi = 10 to 1000 MHz fR = 1200 to 2800 MHz, fL = 1200 to 2800 MHz, fi = 10 to 2000 MHz	dB dB	8.0	8.5	9.0
			9.0	10.0	10.5
SSB Noise Figure		dB	Within 1 dB of conversion loss		
L - R Isolation (min)	fL = 10 to 1200 MHz fL = 1200 to 2800 MHz	dB dB	35	32	30
			30	28	26
L - I Isolation (min)	fL = 10 to 2800 MHz	dB	27	23	21
R - I Isolation (min)	fR = 10 to 2800 MHz	dB	27		
1 dB Conversion Comp.	fL = +10 dBm	dBm	+7		
Input IP3	fL = 10 to 2800 MHz, fi = 10 to 1000 MHz, fR = 10 to 2800 MHz fL = 2000 to 2800 MHz, fi = 10 to 2000 MHz, fR = 2000 to 2800 MHz	dBm dBm	+20		
			+17		
R-Port VSWR	fR = 10 to 2800 MHz		1.80:1		
L-Port VSWR	fL = 10 to 2000 MHz fL = 2000 to 2800 MHz		1.90:1		
			2.50:1		
I-Port VSWR	fi = 10 to 2200 MHz		1.80:1		

1  
1

M/A-COM Technology Solutions Inc. (MACOM) and its affiliates reserve the right to make changes to the product(s) or information contained herein without notice. Visit [www.macom.com](http://www.macom.com) for additional data sheets and product information.

For further information and support please visit:  
<https://www.macom.com/support>

## Typical Performance Curves

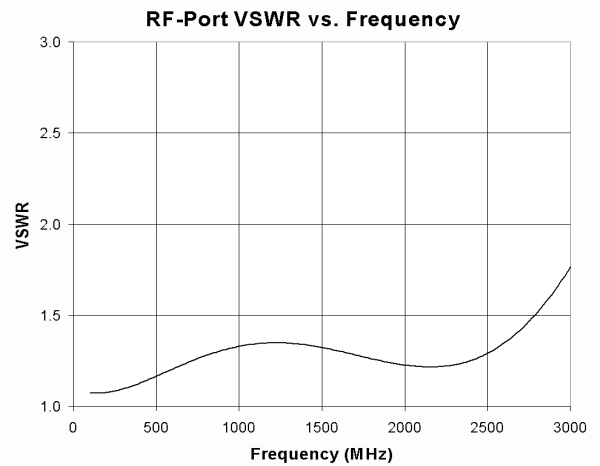
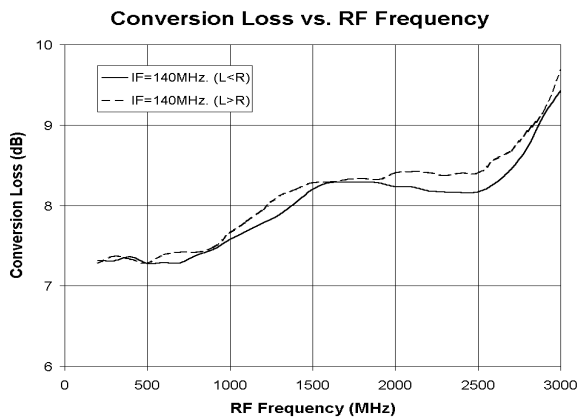
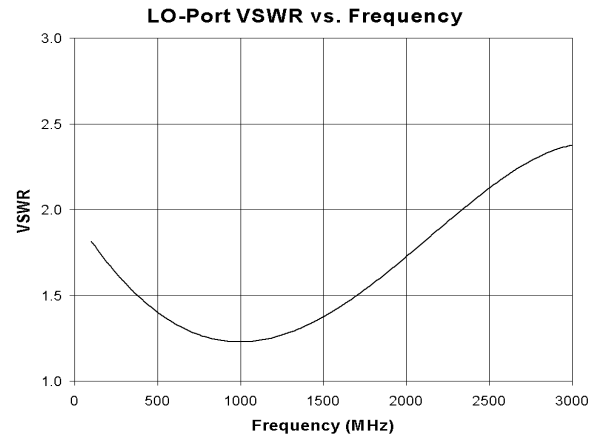
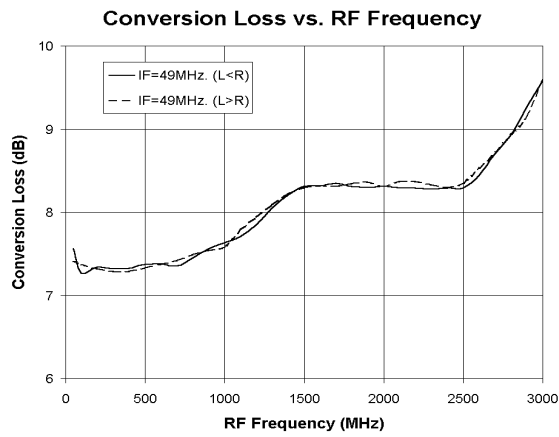
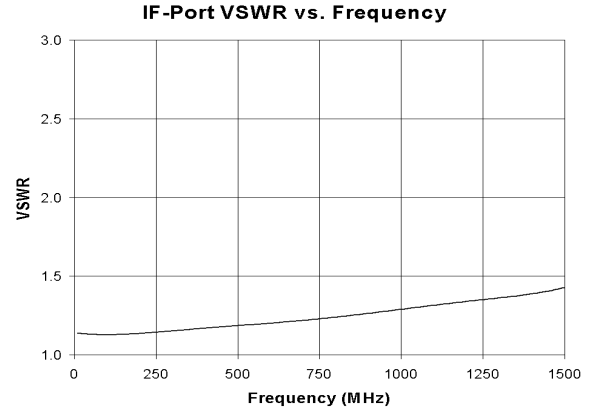
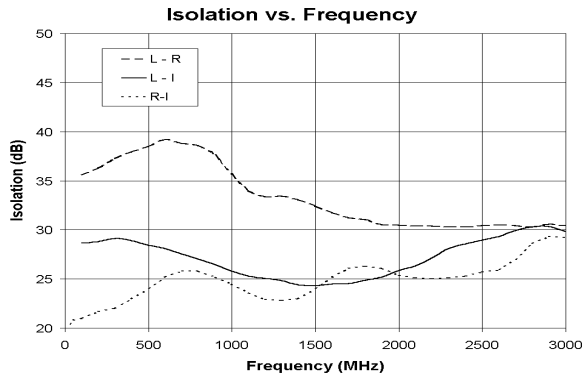

## Outline Drawing: Surface Mount \*

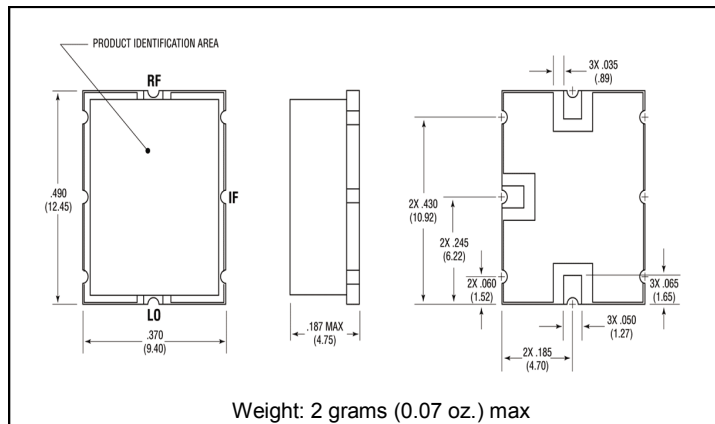

\* Dimensions are inches (millimeters)  $\pm 0.015$  (0.38) unless otherwise specified.

## Absolute Maximum Ratings

Parameter	Absolute Maximum
Operating Temperature	-54°C to +85°C
Storage Temperature	-65°C to +100°C
Peak Input Power	+20 dBm max @ -25°C +17 dBm max @ +85°C
Peak Input Current	50 mA DC

M/A-COM Technology Solutions Inc. All rights reserved.

Information in this document is provided in connection with M/A-COM Technology Solutions Inc ("MACOM") products. These materials are provided by MACOM as a service to its customers and may be used for informational purposes only. Except as provided in MACOM's Terms and Conditions of Sale for such products or in any separate agreement related to this document, MACOM assumes no liability whatsoever. MACOM assumes no responsibility for errors or omissions in these materials. MACOM may make changes to specifications and product descriptions at any time, without notice. MACOM makes no commitment to update the information and shall have no responsibility whatsoever for conflicts or incompatibilities arising from future changes to its specifications and product descriptions. No license, express or implied, by estoppel or otherwise, to any intellectual property rights is granted by this document.

THESE MATERIALS ARE PROVIDED "AS IS" WITHOUT WARRANTY OF ANY KIND, EITHER EXPRESS OR IMPLIED, RELATING TO SALE AND/OR USE OF MACOM PRODUCTS INCLUDING LIABILITY OR WARRANTIES RELATING TO FITNESS FOR A PARTICULAR PURPOSE, CONSEQUENTIAL OR INCIDENTAL DAMAGES, MERCHANTABILITY, OR INFRINGEMENT OF ANY PATENT, COPYRIGHT OR OTHER INTELLECTUAL PROPERTY RIGHT. MACOM FURTHER DOES NOT WARRANT THE ACCURACY OR COMPLETENESS OF THE INFORMATION, TEXT, GRAPHICS OR OTHER ITEMS CONTAINED WITHIN THESE MATERIALS. MACOM SHALL NOT BE LIABLE FOR ANY SPECIAL, INDIRECT, INCIDENTAL, OR CONSEQUENTIAL DAMAGES, INCLUDING WITHOUT LIMITATION, LOST REVENUES OR LOST PROFITS, WHICH MAY RESULT FROM THE USE OF THESE MATERIALS.

MACOM products are not intended for use in medical, lifesaving or life sustaining applications. MACOM customers using or selling MACOM products for use in such applications do so at their own risk and agree to fully indemnify MACOM for any damages resulting from such improper use or sale.