

## Dual 50MHz to 1000MHz High-Linearity, Serial/Analog-Controlled VGA

### General Description

The MAX2064 high-linearity, dual analog variable-gain amplifier (VGA) operates in the 50MHz to 1000MHz frequency range. Each analog attenuator is controlled using an external voltage, or through the SPI-compatible interface using an on-chip 8-bit DAC.

Since each of the stages has its own external RF input and RF output, this component can be configured to either optimize noise figure (NF) (amplifier configured first) or OIP3 (amplifier last). The device's performance features include 24dB amplifier gain (amplifier only), 4.4dB NF at maximum gain (includes attenuator insertion losses), and a high OIP3 level of +41dBm. Each of these features makes the device an ideal VGA for multipath receiver and transmitter applications.

In addition, the device operates from a single +5V supply with full performance, or a +3.3V supply for an enhanced power-savings mode with lower performance. The device is available in a compact 48-pin TQFN package (7mm x 7mm) with an exposed pad. Electrical performance is guaranteed over the extended temperature range, from  $T_C = -40^{\circ}\text{C}$  to  $+85^{\circ}\text{C}$ .

### Applications

IF and RF Gain Stages  
 Temperature-Compensation Circuits  
 WCDMA, TD-SCDMA, and cdma2000® Base Stations  
 GSM 850/GSM 900 EDGE Base Stations  
 WiMAX®, LTE, and TD-LTE Base Stations and Customer-Premise Equipment  
 Fixed Broadband Wireless Access  
 Wireless Local Loop

*cdma2000 is a registered certification mark and registered service mark of the Telecommunications Industry Association.*

*WiMAX is a registered certification mark and registered service mark of the WiMAX Forum.*

### Features

- ◆ Independently Controlled Dual Paths
- ◆ 50MHz to 1000MHz RF Frequency Range
- ◆ Pin-Compatible Family Includes  
     MAX2062 (Analog/Digital VGA)  
     MAX2063 (Digital-Only VGA)
- ◆ 22dB (typ) Maximum Gain
- ◆ 0.19dB Gain Flatness Over 100MHz Bandwidth
- ◆ 33dB Gain Range
- ◆ 49dB Path Isolation (at 200MHz)
- ◆ Built-In 8-Bit DACs for Analog Attenuation Control
- ◆ Excellent Linearity at 200MHz (Configured with Amp Last)
  - +41dBm OIP3
  - +59dBm OIP2
  - +19dBm Output 1dB Compression Point
- ◆ 4.4dB Typical Noise Figure (at 200MHz)
- ◆ Single +5V Supply (or +3.3V Operation)
- ◆ Amplifier Power-Down Mode for TDD Applications

### Ordering Information

PART	TEMP RANGE	PIN-PACKAGE
MAX2064ETM+	-40°C to +85°C	48 TQFN-EP*
MAX2064ETM+T	-40°C to +85°C	48 TQFN-EP*

+ Denotes a lead(Pb)-free/RoHS-compliant package.

\*EP = Exposed pad.

T = Tape and reel.

# MAX2064

## ual 50MHz to 1000MHz High-Linearity, Serial/Analog-Controlled VGA

### ABSOLUTE MAXIMUM RATINGS

VCC\_AMP\_1, VCC\_AMP\_2, VCC\_RG to GND .....-0.3V to +5.5V  
 PD\_1, PD\_2, AMPSET to GND .....-0.3V to +3.6V  
 A\_VCTL\_1, A\_VCTL\_2 to GND .....-0.3V to +3.6V  
 DAT, CS, CLK, AA\_SP to GND .....-0.3V to +3.6V  
 AMP\_IN\_1, AMP\_IN\_2 to GND .....+0.95V to +1.2V  
 AMP\_OUT\_1, AMP\_OUT\_2 to GND .....-0.3V to +5.5V  
 A\_ATT\_IN\_1, A\_ATT\_IN\_2, A\_ATT\_OUT\_1,  
 A\_ATT\_OUT\_2 to GND .....0V to +3.6V  
 REG\_OUT to GND .....-0.3V to +3.6V  
 RF Input Power (A\_ATT\_IN\_1, A\_ATT\_IN\_2)..... +20dBm

RF Input Power (AMP\_IN\_1, AMP\_IN\_2)..... +18dBm  
 $\theta_{JC}$  (Notes 1, 2)..... +12.3°C/W  
 $\theta_{JA}$  (Notes 2, 3)..... +38°C/W  
 Continuous Power Dissipation (Note 1) .....5.3W  
 Operating Case Temperature Range (Note 4) .. -40°C to +85°C  
 Junction Temperature .....+150°C  
 Storage Temperature Range.....-65°C to +150°C  
 Lead Temperature (soldering, 10s) .....+300°C  
 Soldering Temperature (reflow) .....+260°C

- Note 1:** Based on junction temperature  $T_J = T_C + (\theta_{JC} \times V_{CC} \times I_{CC})$ . This formula can be used when the temperature of the exposed pad is known while the device is soldered down to a PCB. See the *Applications Information* section for details. The junction temperature must not exceed +150°C.
- Note 2:** Package thermal resistances were obtained using the method described in JEDEC specification JESD51-7, using a four-layer board. For detailed information on package thermal considerations, refer to [www.maximintegrated.com/thermal-tutorial](http://www.maximintegrated.com/thermal-tutorial).
- Note 3:** Junction temperature  $T_J = T_A + (\theta_{JA} \times V_{CC} \times I_{CC})$ . This formula can be used when the ambient temperature of the PCB is known. The junction temperature must not exceed +150°C.
- Note 4:**  $T_C$  is the temperature on the exposed pad of the package.  $T_A$  is the ambient temperature of the device and PCB.

*Stresses beyond those listed under "Absolute Maximum Ratings" may cause permanent damage to the device. These are stress ratings only, and functional operation of the device at these or any other conditions beyond those indicated in the operational sections of the specifications is not implied. Exposure to absolute maximum rating conditions for extended periods may affect device reliability.*

### +5V SUPPLY DC ELECTRICAL CHARACTERISTICS

(Typical Application Circuit,  $V_{CC} = V_{CC\_AMP\_1} = V_{CC\_AMP\_2} = V_{CC\_RG} = +4.75V$  to +5.25V, AMPSET = 0, PD\_1 = PD\_2 = 0,  $T_C = -40^\circ C$  to +85°C. Typical values are at  $V_{CC\_} = +5.0V$  and  $T_C = +25^\circ C$ , unless otherwise noted.)

PARAMETER	SYMBOL	CONDITIONS	MIN	TYP	MAX	UNITS
Supply Voltage	$V_{CC}$		4.75	5	5.25	V
Supply Current	$I_{DC}$			143	210	mA
Power-Down Current	$I_{DCPD}$	PD_1 = PD_2 = 1, $V_{IH} = 3.3V$		5.3	8	mA
Input Low Voltage	$V_{IL}$				0.5	V
Input High Voltage	$V_{IH}$		1.7		3.465	V
Input Logic Current	$I_{IH}, I_{IL}$		-1		+1	$\mu A$

### +3.3V SUPPLY DC ELECTRICAL CHARACTERISTICS

(Typical Application Circuit,  $V_{CC} = V_{CC\_AMP\_1} = V_{CC\_AMP\_2} = V_{CC\_RG} = +3.135V$  to +3.465V, AMPSET = 1, PD\_1 = PD\_2 = 0,  $T_C = -40^\circ C$  to +85°C. Typical values are at  $V_{CC\_} = +3.3V$  and  $T_C = +25^\circ C$ , unless otherwise noted.)

PARAMETER	SYMBOL	CONDITIONS	MIN	TYP	MAX	UNITS
Supply Voltage	$V_{CC}$		3.135	3.3	3.465	V
Supply Current	$I_{DC}$			84.7	145	mA
Power-Down Current	$I_{DCPD}$	PD_1 = PD_2 = 1, $V_{IH} = 3.3V$		4.5	8	mA
Input Low Voltage	$V_{IL}$				0.5	V
Input High Voltage	$V_{IH}$			1.7		V

## Dual 50MHz to 1000MHz High-Linearity, Serial/Analog-Controlled VGA

### RECOMMENDED AC OPERATING CONDITIONS

PARAMETER	SYMBOL	CONDITIONS	MIN	TYP	MAX	UNITS
RF Frequency	$f_{RF}$	(Note 5)	50		1000	MHz

### +5V SUPPLY AC ELECTRICAL CHARACTERISTICS (each path, unless otherwise noted)

(Typical Application Circuit,  $V_{CC} = V_{CC\_AMP\_1} = V_{CC\_AMP\_2} = V_{CC\_RG} = +4.75V$  to  $+5.25V$ , attenuators are set for maximum gain, RF ports are driven from  $50\Omega$  sources,  $AMPSET = 0$ ,  $PD\_1 = PD\_2 = 0$ ,  $100MHz \leq f_{RF} \leq 500MHz$ ,  $T_C = -40^\circ C$  to  $+85^\circ C$ . Typical values are at maximum gain setting,  $V_{CC} = +5.0V$ ,  $P_{IN} = -20dBm$ ,  $f_{RF} = 350MHz$ , and  $T_C = +25^\circ C$ , unless otherwise noted.) (Note 6)

PARAMETER	SYMBOL	CONDITIONS	MIN	TYP	MAX	UNITS
Small-Signal Gain	G	$f_{RF} = 50MHz$		22.4		dB
		$f_{RF} = 100MHz$		22.3		
		$f_{RF} = 200MHz$		22.2		
		$f_{RF} = 350MHz, T_C = +25^\circ C$	19.5	21.9	23.5	
		$f_{RF} = 450MHz$		21.7		
		$f_{RF} = 750MHz$		21.4		
		$f_{RF} = 900MHz$		20.6		
Gain vs. Temperature				-0.006		dB/ $^\circ C$
Gain Flatness vs. Frequency		From 100MHz to 200MHz		0.18		dB
		Any 100MHz frequency band from 200MHz to 500MHz		0.19		
Noise Figure	NF	$f_{RF} = 50MHz$		4.4		dB
		$f_{RF} = 100MHz$		4.4		
		$f_{RF} = 200MHz$		4.4		
		$f_{RF} = 350MHz$		4.6		
		$f_{RF} = 450MHz$		4.7		
		$f_{RF} = 750MHz$		5.3		
		$f_{RF} = 900MHz$		5.7		
Total Attenuation Range		$f_{RF} = 350MHz, T_C = +25^\circ C$	30	32.9		dB
Output Second-Order Intercept Point	OIP2	$P_{OUT} = 0dBm/$ tone, $\Delta f = 1MHz, f_1 + f_2$		53.7		dBm
Path Isolation		RF input 1 amplified power measured at RF output 2 relative to RF output 1, all unused ports terminated to $50\Omega$		48.7		dB
		RF input 2 amplified signal measured at RF output 1 relative to RF output 2, all unused ports terminated to $50\Omega$		48.6		
Output Third-Order Intercept Point	OIP3	$P_{OUT} = 0dBm/$ tone, $\Delta f = 1MHz, f_{RF} = 50MHz$		46.3		dBm
		$P_{OUT} = 0dBm/$ tone, $\Delta f = 1MHz, f_{RF} = 100MHz$		44.2		
		$P_{OUT} = 0dBm/$ tone, $\Delta f = 1MHz, f_{RF} = 200MHz$		41.1		
		$P_{OUT} = 0dBm/$ tone, $\Delta f = 1MHz, f_{RF} = 350MHz$		37.1		
		$P_{OUT} = 0dBm/$ tone, $\Delta f = 1MHz, f_{RF} = 450MHz$		34.9		
		$P_{OUT} = 0dBm/$ tone, $\Delta f = 1MHz, f_{RF} = 750MHz$		28.2		
		$P_{OUT} = 0dBm/$ tone, $\Delta f = 1MHz, f_{RF} = 900MHz$		24.6		

# MAX2064

## ual 50MHz to 1000MHz High-Linearity, Serial/Analog-Controlled VGA

### +5V SUPPLY AC ELECTRICAL CHARACTERISTICS (each path, unless otherwise noted) (continued)

(Typical Application Circuit,  $V_{CC} = V_{CC\_AMP\_1} = V_{CC\_AMP\_2} = V_{CC\_RG} = +4.75V$  to  $+5.25V$ , attenuators are set for maximum gain, RF ports are driven from  $50\Omega$  sources,  $AMPSET = 0$ ,  $PD\_1 = PD\_2 = 0$ ,  $100MHz \leq f_{RF} \leq 500MHz$ ,  $T_C = -40^\circ C$  to  $+85^\circ C$ . Typical values are at maximum gain setting,  $V_{CC} = +5.0V$ ,  $P_{IN} = -20dBm$ ,  $f_{RF} = 350MHz$ , and  $T_C = +25^\circ C$ , unless otherwise noted.) (Note 6)

PARAMETER	SYMBOL	CONDITIONS	MIN	TYP	MAX	UNITS
Output -1dB Compression Point	$P_{1dB}$	$f_{RF} = 350MHz$ , $T_C = +25^\circ C$ (Note 7)	17	18.7		dBm
Second Harmonic		$P_{OUT} = +3dBm$		-56.7		dBc
Third Harmonic		$P_{OUT} = +3dBm$		-72.4		dBc
Group Delay		Includes EV kit PCB delays		0.9		ns
Amplifier Power-Down Time		$PD\_1$ or $PD\_2$ from 0 to 1, amplifier DC supply current settles to within 0.1mA		0.5		$\mu s$
Amplifier Power-Up Time		$PD\_1$ or $PD\_2$ from 1 to 0, amplifier DC supply current settles to within 1%		0.5		$\mu s$
Input Return Loss	$RL_{IN}$	$50\Omega$ source		16.8		dB
Output Return Loss	$RL_{OUT}$	$50\Omega$ load		30.7		dB
<b>ANALOG ATTENUATOR (each path, unless otherwise noted)</b>						
Insertion Loss	IL			2.2		dB
Input Second-Order Intercept Point	IIP2	$P_{IN1} = 0dBm$ , $P_{IN2} = 0dBm$ (minimum attenuation), $\Delta f = 1MHz$ , $f_1 + f_2$		61.9		dBm
Input Third-Order Intercept Point	IIP3	$P_{IN1} = 0dBm$ , $P_{IN2} = 0dBm$ (minimum attenuation), $\Delta f = 1MHz$		37.0		dBm
Attenuation Range				32.9		dB
Gain Control Slope		Analog control input		-13.3		dB/V
Maximum Gain Control Slope		Over analog control input range		-35.2		dB/V
Insertion Phase Change		Over analog control input range		16.5		Deg/V
Attenuator Response Time		RF settled to within $\pm 0.5dB$	31dB to 0dB, AA_SP = 0, from A_VCTL_ step	500		ns
			31dB to 0dB, AA_SP = 1, from $\overline{CS}$ step	500		
			0dB to 31dB, AA_SP = 0, from A_VCTL_ step	500		
			0dB to 31dB, AA_SP = 1, from $\overline{CS}$ step	500		
Group Delay vs. Control Voltage		Over analog control input from 0.25V to 2.75V		-0.26		ns
Analog Control Input Range			0.25		2.75	V
Analog Control Input Impedance				19.2		k $\Omega$
Input Return Loss		$50\Omega$ source		16.0		dB
Output Return Loss		$50\Omega$ load		15.9		dB

## Dual 50MHz to 1000MHz High-Linearity, Serial/Analog-Controlled VGA

### +5V SUPPLY AC ELECTRICAL CHARACTERISTICS (each path, unless otherwise noted) (continued)

(Typical Application Circuit,  $V_{CC} = V_{CC\_AMP\_1} = V_{CC\_AMP\_2} = V_{CC\_RG} = +4.75V$  to  $+5.25V$ , attenuators are set for maximum gain, RF ports are driven from  $50\Omega$  sources,  $AMPSET = 0$ ,  $PD\_1 = PD\_2 = 0$ ,  $100MHz \leq f_{RF} \leq 500MHz$ ,  $T_C = -40^\circ C$  to  $+85^\circ C$ . Typical values are at maximum gain setting,  $V_{CC} = +5.0V$ ,  $P_{IN} = -20dBm$ ,  $f_{RF} = 350MHz$ , and  $T_C = +25^\circ C$ , unless otherwise noted.) (Note 6)

PARAMETER	SYMBOL	CONDITIONS	MIN	TYP	MAX	UNITS
<b>D/A CONVERTER</b>						
Number of Bits				8		Bits
Output Voltage		DAC code = 00000000			0.35	V
		DAC code = 11111111	2.7			
<b>SERIAL PERIPHERAL INTERFACE (SPI)</b>						
Maximum Clock Speed				20		MHz
Data-to-Clock Setup Time	tCS			2		ns
Data-to-Clock Hold Time	tCH			2.5		ns
Clock-to- $\overline{CS}$ Setup Time	tES			3		ns
$\overline{CS}$ Positive Pulse Width	tEW			7		ns
$\overline{CS}$ Setup Time	tEWS			3.5		ns
Clock Pulse Width	tCW			5		ns

### +3.3V SUPPLY AC ELECTRICAL CHARACTERISTICS (each path, unless otherwise noted)

(Typical Application Circuit,  $V_{CC} = V_{CC\_AMP\_1} = V_{CC\_AMP\_2} = V_{CC\_RG} = +3.135V$  to  $+3.465V$ , attenuators are set for maximum gain, RF ports are driven from  $50\Omega$  sources,  $AMPSET = 1$ ,  $PD\_1 = PD\_2 = 0$ ,  $100MHz \leq f_{RF} \leq 500MHz$ ,  $T_C = -40^\circ C$  to  $+85^\circ C$ . Typical values are at maximum gain setting,  $V_{CC} = +3.3V$ ,  $P_{IN} = -20dBm$ ,  $f_{RF} = 350MHz$ , and  $T_C = +25^\circ C$ , unless otherwise noted.) (Note 6)

PARAMETER	SYMBOL	CONDITIONS	MIN	TYP	MAX	UNITS
Small-Signal Gain	G			21.8		dB
Output Third-Order Intercept Point	OIP3	$P_{OUT} = 0dBm/$ tone		29.1		dBm
Noise Figure	NF			4.8		dB
Total Attenuation Range				32.9		dB
Path Isolation		RF input 1 amplified power measured at RF output 2 relative to RF output 1, all unused ports terminated to $50\Omega$		48.1		dB
		RF input 2 amplified signal measured at RF output 1 relative to RF output 2, all unused ports terminated to $50\Omega$		48.2		
Output -1dB Compression Point	P1dB	(Note 7)		13.2		dBm

**Note 5:** Operation outside this range is possible, but with degraded performance of some parameters. See the *Typical Operating Characteristics*.

**Note 6:** All limits include external component losses. Output measurements are performed at the RF output port of the *Typical Application Circuit*.

**Note 7:** It is advisable not to continuously operate the RF input 1 or RF input 2 above  $+15dBm$ .

# MAX2064

## ual 50MHz to 1000MHz High-Linearity, Serial/Analog-Controlled VGA

### Typical Operating Characteristics

(Typical Application Circuit,  $V_{CC} = V_{CC\_AMP\_1} = V_{CC\_AMP\_2} = V_{CC\_RG} = +5V$ , attenuators are set for maximum gain, RF ports are driven from  $50\Omega$  sources,  $AMPSET = 0$ ,  $PD\_1 = PD\_2 = 0$ ,  $P_{IN} = -20dBm$ ,  $f_{RF} = 350MHz$ , and  $T_C = +25^\circ C$ , unless otherwise noted.)

**SUPPLY CURRENT vs. SUPPLY VOLTAGE**

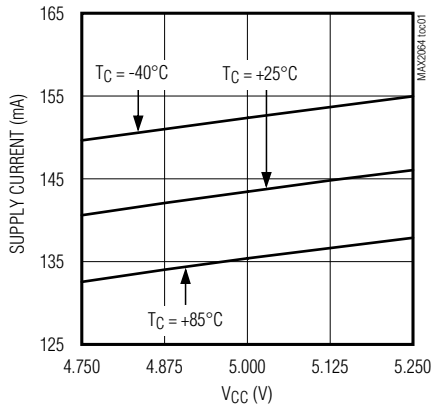

**GAIN vs. RF FREQUENCY**

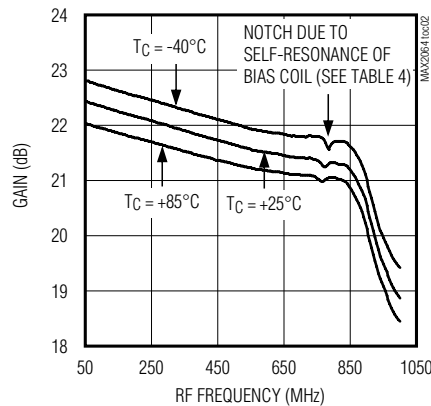

**GAIN vs. RF FREQUENCY**

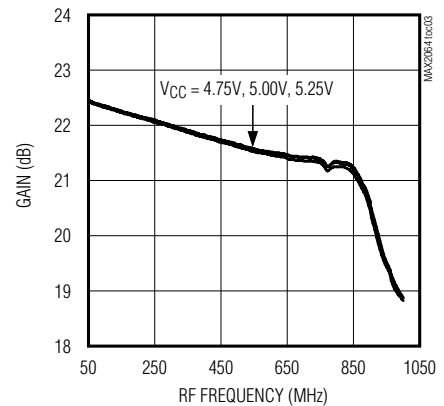

**GAIN OVER ANALOG ATTENUATOR SETTING vs. RF FREQUENCY**

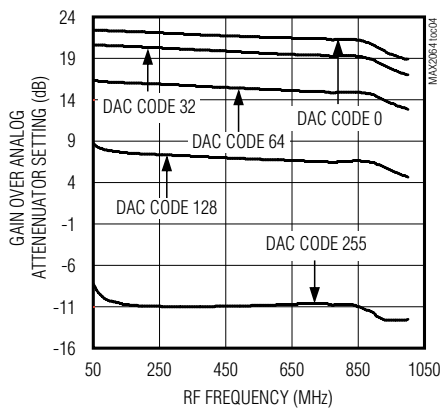

**GAIN vs. ANALOG ATTENUATOR SETTING**

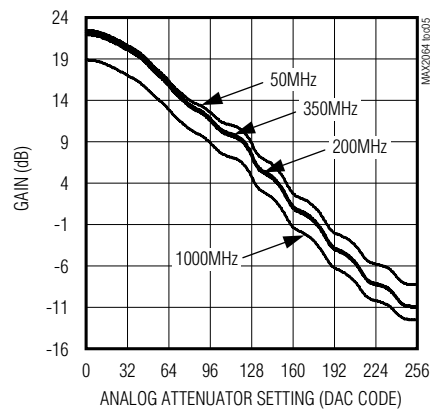

**GAIN vs. ANALOG ATTENUATOR SETTING**

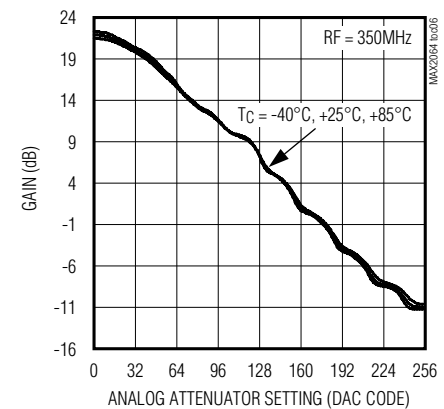

**GAIN vs. ANALOG ATTENUATOR SETTING**

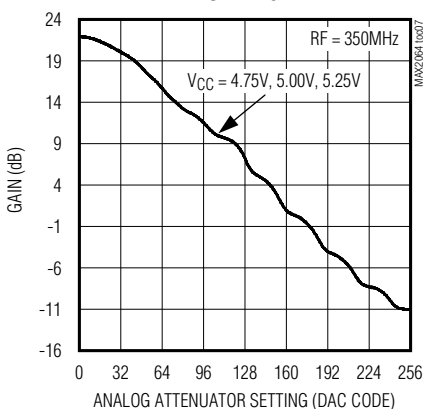

**INPUT MATCH vs. ANALOG ATTENUATOR SETTING**

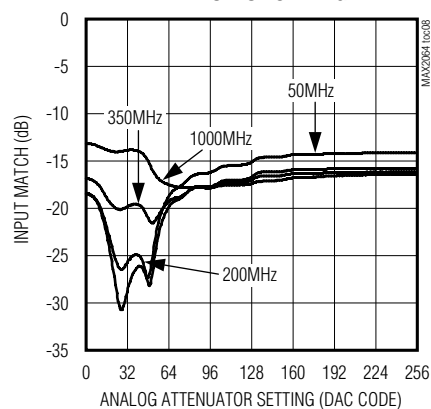

**OUTPUT MATCH vs. ANALOG ATTENUATOR SETTING**

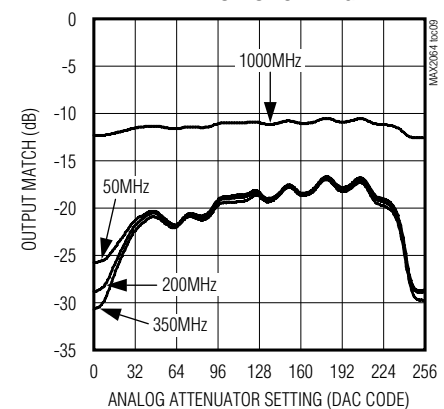

## Dual 50MHz to 1000MHz High-Linearity, Serial/Analog-Controlled VGA

### Typical Operating Characteristics (continued)

(Typical Application Circuit,  $V_{CC} = V_{CC\_AMP\_1} = V_{CC\_AMP\_2} = V_{CC\_RG} = +5V$ , attenuators are set for maximum gain, RF ports are driven from  $50\Omega$  sources,  $AMPSET = 0$ ,  $PD\_1 = PD\_2 = 0$ ,  $P_{IN} = -20dBm$ ,  $f_{RF} = 350MHz$ , and  $T_C = +25^\circ C$ , unless otherwise noted.)

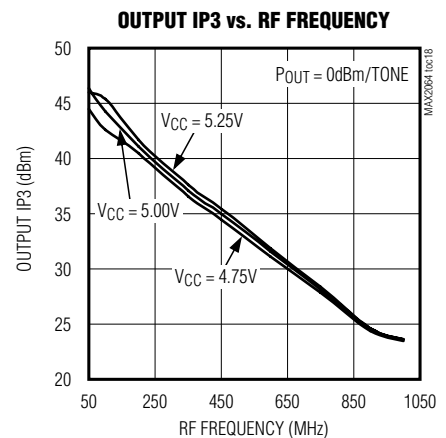
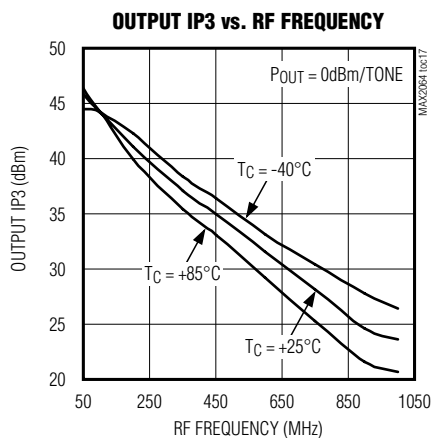
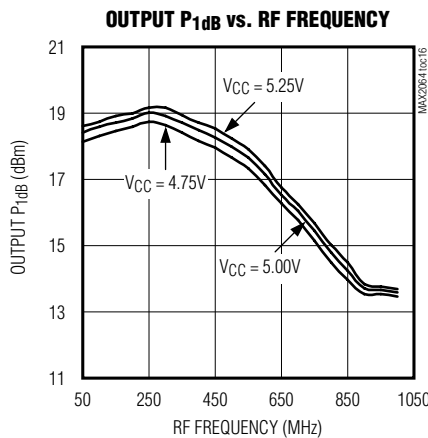
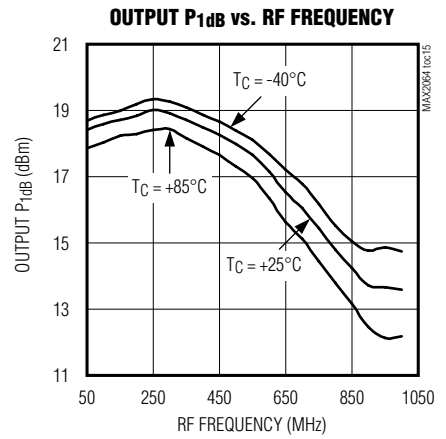
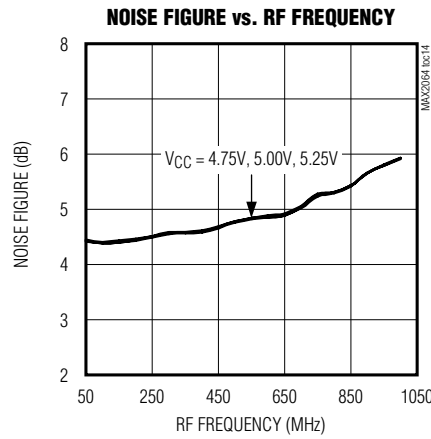
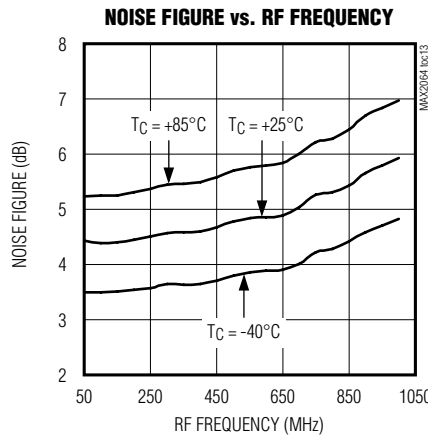
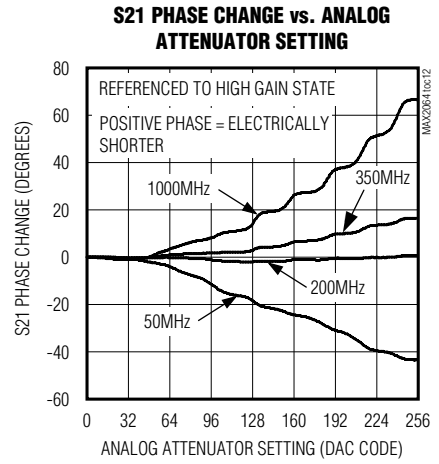
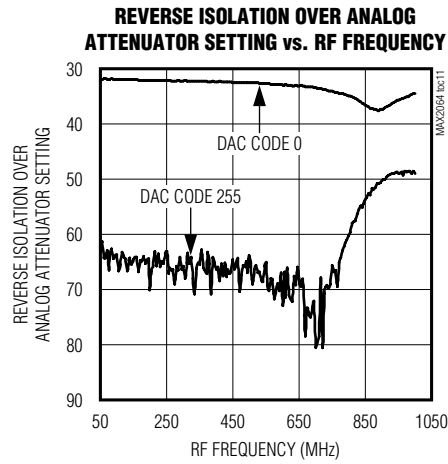
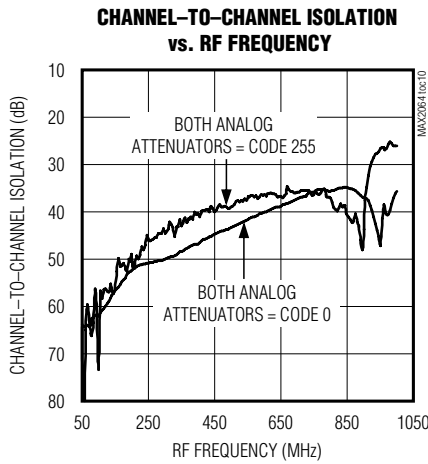

# MAX2064

## ual 50MHz to 1000MHz High-Linearity, Serial/Analog-Controlled VGA

### Typical Operating Characteristics (continued)

(Typical Application Circuit,  $V_{CC} = V_{CC\_AMP\_1} = V_{CC\_AMP\_2} = V_{CC\_RG} = +5V$ , attenuators are set for maximum gain, RF ports are driven from  $50\Omega$  sources,  $AMPSET = 0$ ,  $PD\_1 = PD\_2 = 0$ ,  $P_{IN} = -20dBm$ ,  $f_{RF} = 350MHz$ , and  $T_C = +25^\circ C$ , unless otherwise noted.)

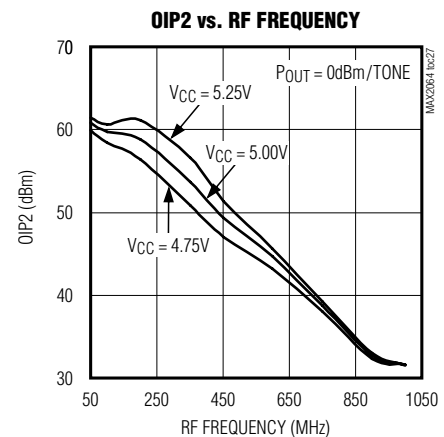
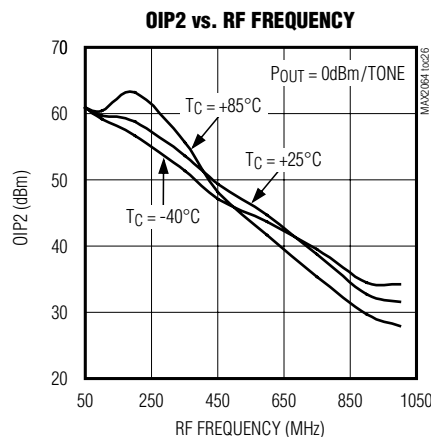
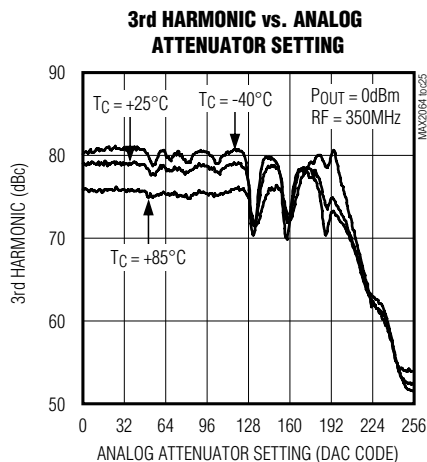
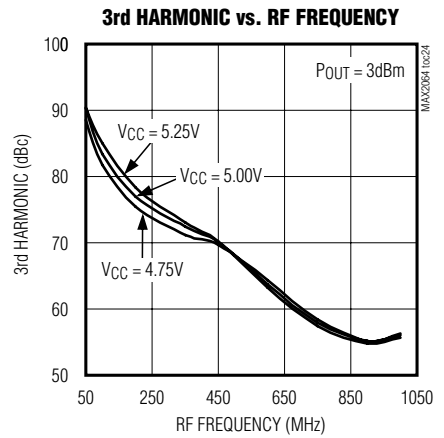
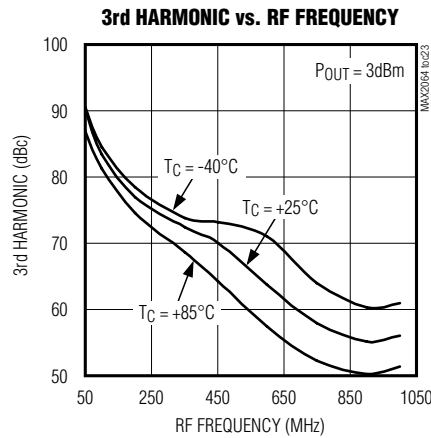
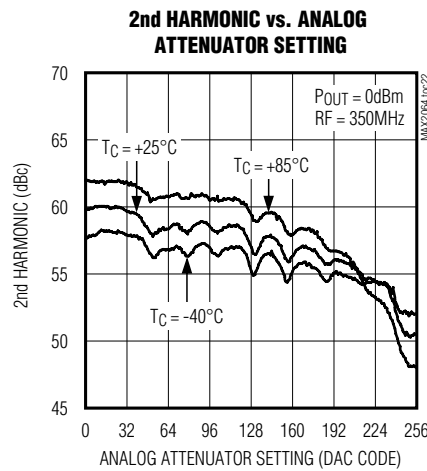
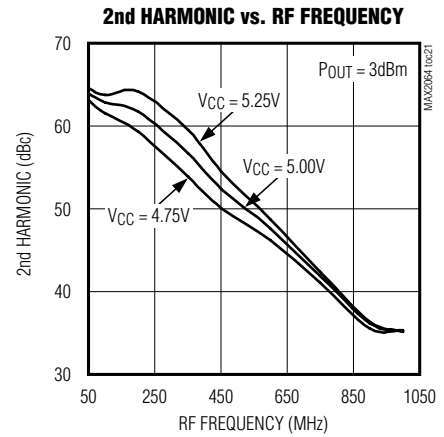
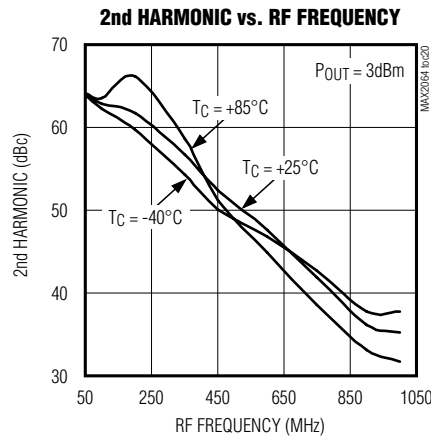
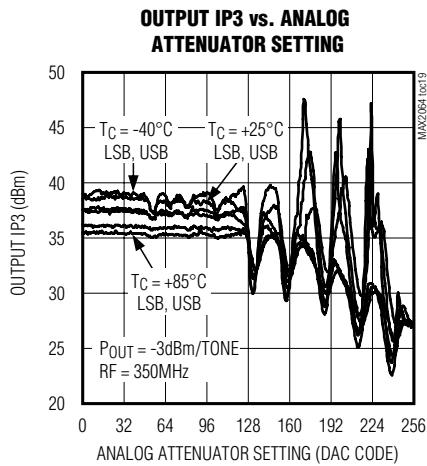



# MAX2064

## Dual 50MHz to 1000MHz High-Linearity, Serial/Analog-Controlled VGA

### Typical Operating Characteristics (continued)

(Typical Application Circuit,  $V_{CC} = V_{CC\_AMP\_1} = V_{CC\_AMP\_2} = V_{CC\_RG} = +5V$ , attenuators are set for maximum gain, RF ports are driven from  $50\Omega$  sources,  $AMPSET = 0$ ,  $PD\_1 = PD\_2 = 0$ ,  $P_{IN} = -20dBm$ ,  $f_{RF} = 350MHz$ , and  $T_C = +25^\circ C$ , unless otherwise noted.)

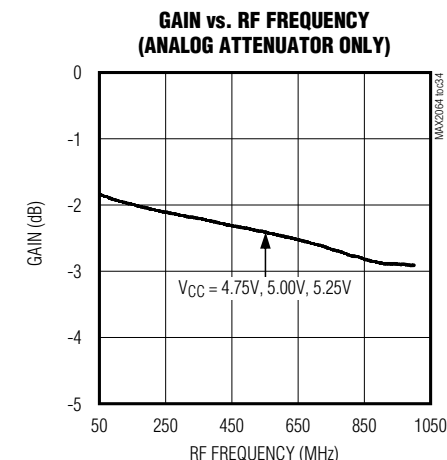
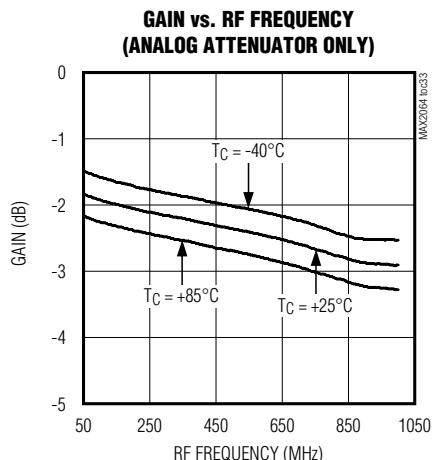
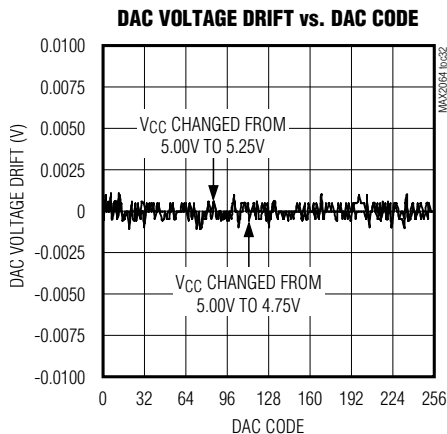
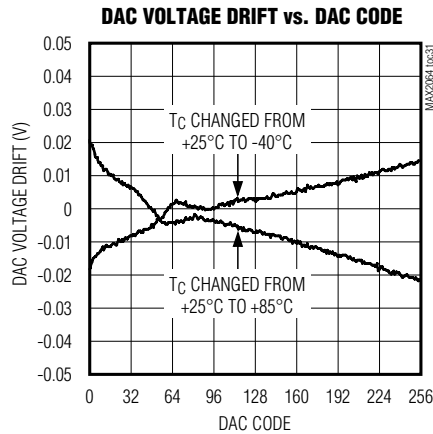
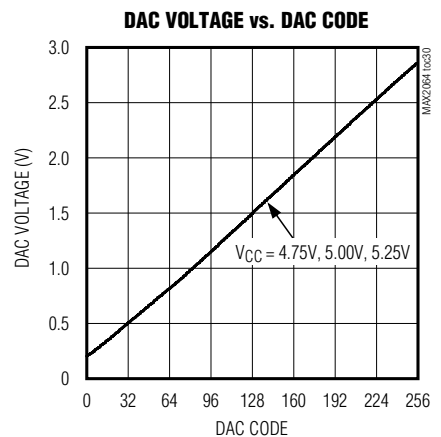
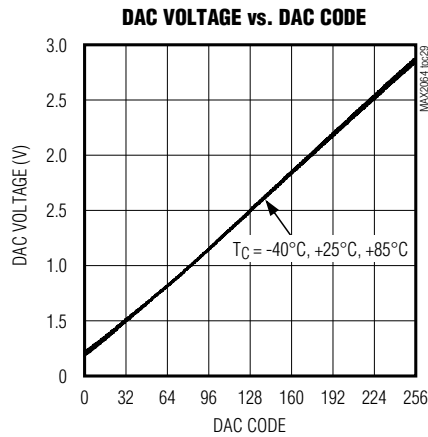
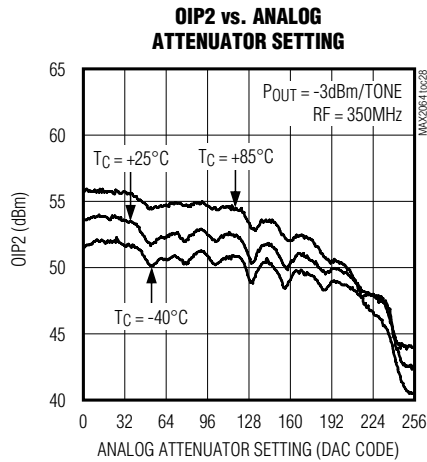

# MAX2064

## ual 50MHz to 1000MHz High-Linearity, Serial/Analog-Controlled VGA

### Typical Operating Characteristics (continued)

(Typical Application Circuit,  $V_{CC} = V_{CC\_AMP\_1} = V_{CC\_AMP\_2} = V_{CC\_RG} = +3.3V$ , attenuators are set for maximum gain, RF ports are driven from  $50\Omega$  sources, AMPSET = 1, PD\_1 = PD\_2 = 0, P<sub>IN</sub> = -20dBm, f<sub>RF</sub> = 350MHz, and T<sub>C</sub> = +25°C, unless otherwise noted.)

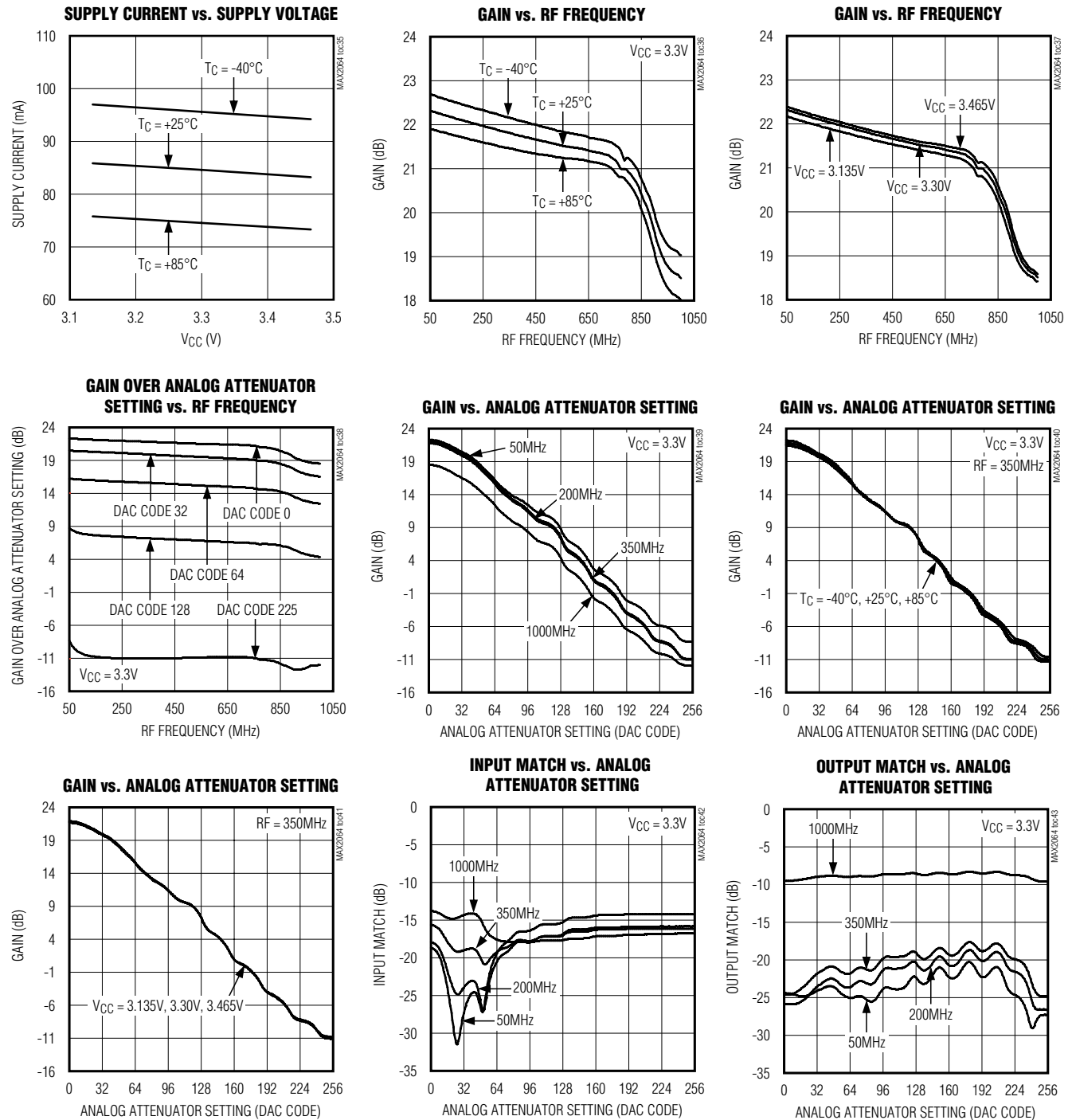

## Dual 50MHz to 1000MHz High-Linearity, Serial/Analog-Controlled VGA

### Typical Operating Characteristics (continued)

(Typical Application Circuit,  $V_{CC} = V_{CC\_AMP\_1} = V_{CC\_AMP\_2} = V_{CC\_RG} = +3.3V$ , attenuators are set for maximum gain, RF ports are driven from  $50\Omega$  sources,  $AMPSET = 1$ ,  $PD\_1 = PD\_2 = 0$ ,  $P_{IN} = -20dBm$ ,  $f_{RF} = 350MHz$ , and  $T_C = +25^\circ C$ , unless otherwise noted.)

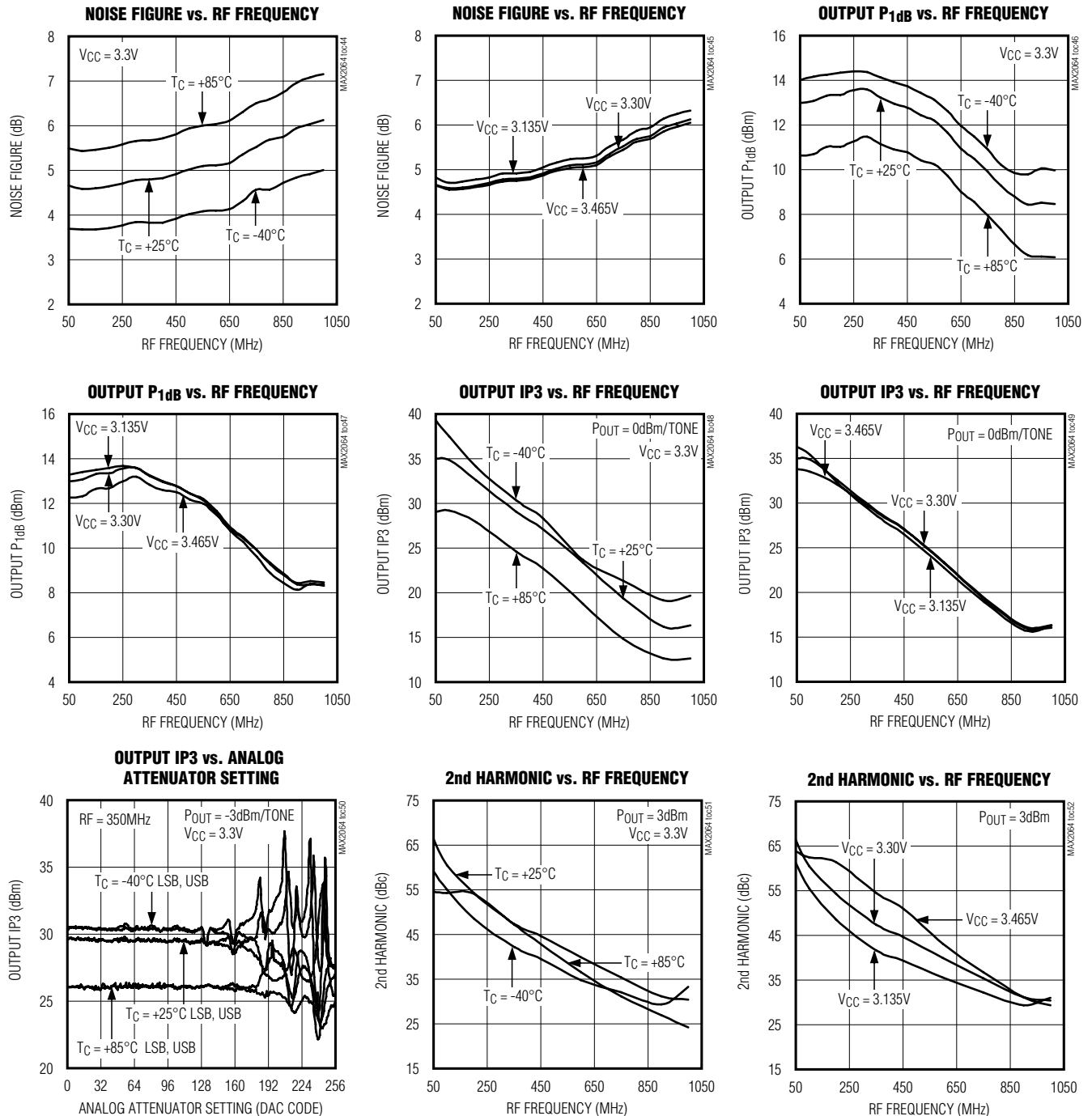

# MAX2064

## ual 50MHz to 1000MHz High-Linearity, Serial/Analog-Controlled VGA

### Typical Operating Characteristics (continued)

(Typical Application Circuit,  $V_{CC} = V_{CC\_AMP\_1} = V_{CC\_AMP\_2} = V_{CC\_RG} = +3.3V$ , attenuators are set for maximum gain, RF ports are driven from  $50\Omega$  sources, AMPSET = 1, PD\_1 = PD\_2 = 0, PIN = -20dBm, f<sub>RF</sub> = 350MHz, and T<sub>C</sub> = +25°C, unless otherwise noted.)

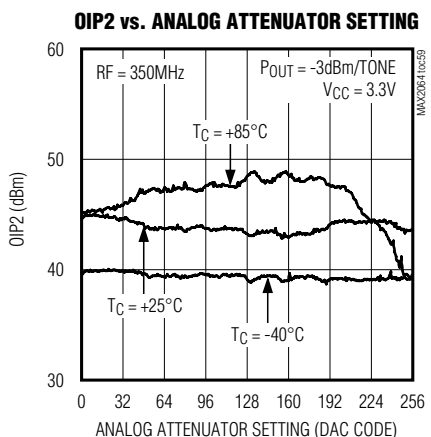
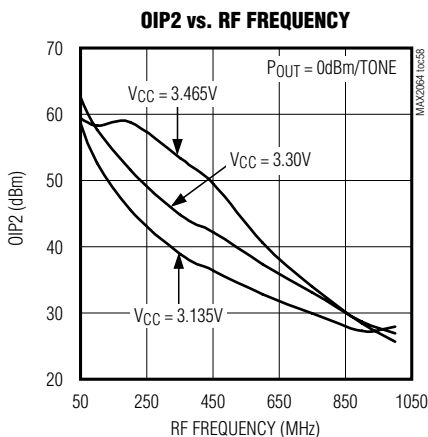
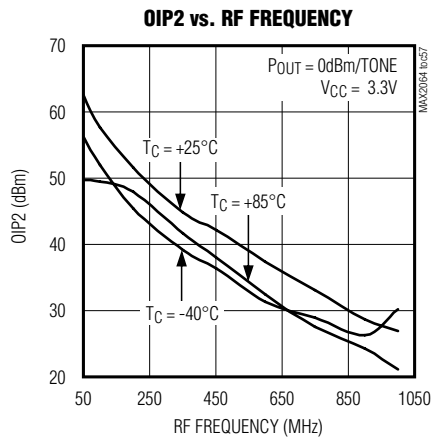
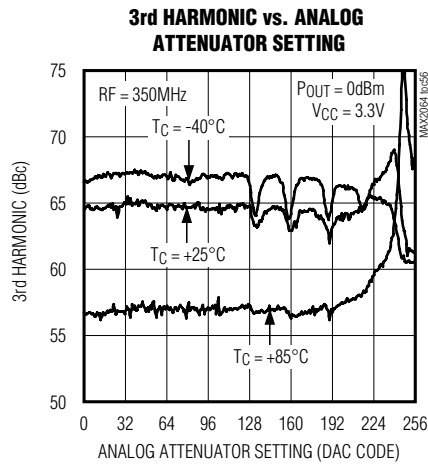
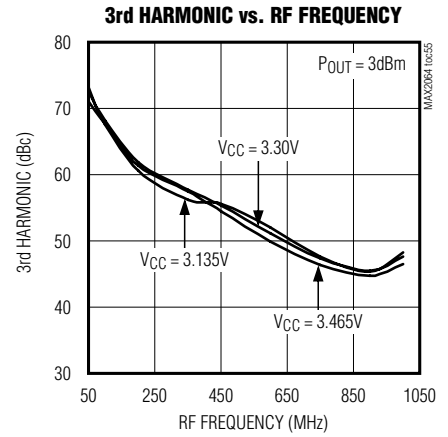
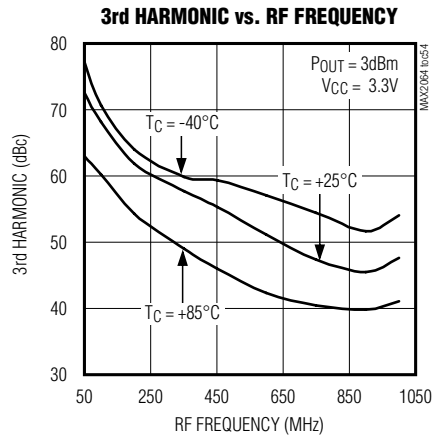
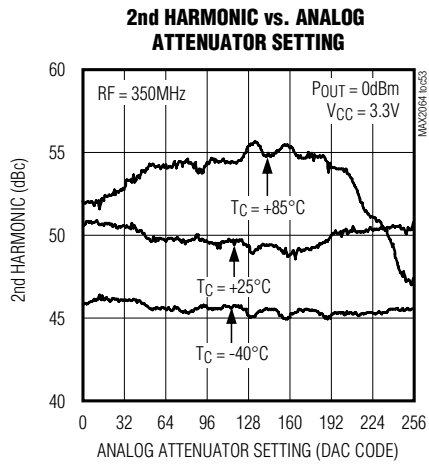

# MAX2064

## Dual 50MHz to 1000MHz High-Linearity, Serial/Analog-Controlled VGA

### Pin Configuration

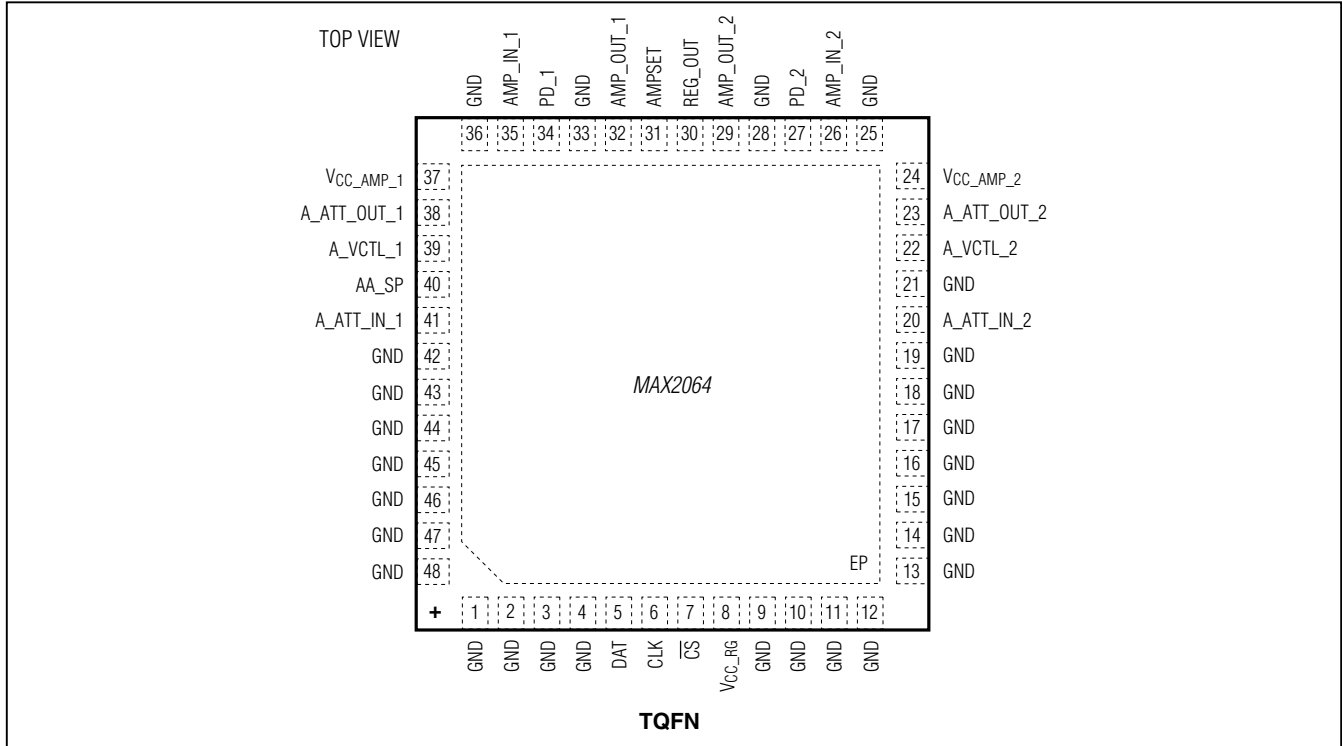

### Pin Description

PIN	NAME	FUNCTION
1–4, 9–19, 21, 25, 28, 33, 36, 42–48	GND	Ground
5	DAT	SPI Data Digital Input
6	CLK	SPI Clock Digital Input
7	$\overline{\text{CS}}$	SPI Chip-Select Digital Input
8	VCC_RG	Regulator Supply Input. Connect to a 3.3V or 5V external power supply. VCC_RG powers all circuits except for the driver amplifiers. Bypass with a 10nF capacitor as close as possible to the pin.
20	A_ATT_IN_2	Analog Attenuator Input (50 $\Omega$ ), Path 2. Requires a 1000pF DC-blocking capacitor.
22	A_VCTL_2	Analog Attenuator Voltage-Control Input, Path 2. Bypass to ground with a 150pF capacitor if DAC 2 is used (AA_SP = 1).
23	A_ATT_OUT_2	Analog Attenuator Output (50 $\Omega$ ), Path 2. Requires a DC-blocking capacitor. Connect to AMP_IN_2 through a 1000pF capacitor.
24	VCC_AMP_2	Driver Amplifier Supply-Voltage Input, Path 2. Bypass with a 10nF capacitor as close as possible to the pin.
26	AMP_IN_2	Driver Amplifier Input (50 $\Omega$ ), Path 2. Requires a DC-blocking capacitor. Connect to A_ATT_OUT_2 through a 1000pF capacitor.
27	PD_2	Power-Down, Path 2. See Table 2 for operation details.
29	AMP_OUT_2	Driver Amplifier Output (50 $\Omega$ ), Path 2. Connect a pullup inductor from AMP_OUT_2 to VCC_.

# MAX2064

## ual 50MHz to 1000MHz High-Linearity, Serial/Analog-Controlled VGA

### Pin Description (continued)

PIN	NAME	FUNCTION
30	REG_OUT	Regulator Output. Bypass with 1 $\mu$ F capacitor.
31	AMPSET	Driver Amplifier Bias Setting for 3.3V Operation. Set to logic 1 for 3.3V operation on pins VCC_AMP_1 and VCC_AMP_2. Set to logic 0 for 5V operation.
32	AMP_OUT_1	Driver Amplifier Output (50 $\Omega$ ), Path 1. Connect a pullup inductor from AMP_OUT_1 to VCC_.
34	PD_1	Power-Down, Path 1. See Table 2 for operation details.
35	AMP_IN_1	Driver Amplifier Input (50 $\Omega$ ), Path 1. Requires a DC-blocking capacitor. Connect to A_ATT_OUT_1 through a 1000pF capacitor.
37	VCC_AMP_1	Driver Amplifier Supply Voltage Input, Path 1. Bypass with a 10nF capacitor as close as possible to the pin.
38	A_ATT_OUT_1	Analog Attenuator Output (50 $\Omega$ ), Path 1. Requires a DC-blocking capacitor. Connect to AMP_IN_1 through a 1000pF capacitor.
39	A_VCTL_1	Analog Attenuator Voltage-Control Input, Path 1. Bypass to ground with a 150pF capacitor if on-chip DAC is used (AA_SP = 1).
40	AA_SP	DAC Enable/Disable Logic Input for Analog Attenuators. Set AA_SP to logic 1 to enable on-chip DAC circuit and digital SPI control. Set AA_SP to logic 0 to disable DAC circuit and digital SPI control. When AA_SP = 0, use analog control lines (A_VCTL_1 and A_VCTL_2).
41	A_ATT_IN_1	Analog Attenuator Input (50 $\Omega$ ), Path 1. Requires a 1000pF DC-blocking capacitor.
—	EP	Exposed Pad. Internally connected to GND. Connect to a large PCB ground plane for proper RF performance and enhanced thermal dissipation.

### Detailed Description

The MAX2064 high-linearity analog VGA is a general-purpose, high-performance amplifier designed to interface with 50 $\Omega$  systems operating in the 50MHz to 1000MHz frequency range.

Each channel of the device integrates an analog attenuator to provide 33dB of total gain control, as well as a driver amplifier optimized to provide high gain, high IP3, low NF, and low power consumption.

Each analog attenuator is controlled using an external voltage or through the SPI-compatible interface using an on-chip 8-bit DAC. See the *Applications Information* section and Table 3 for attenuator programming details.

Because each of the two stages in the separate signal paths has its own RF input and RF output, this component can be configured to either optimize NF (amplifier configured first) or OIP3 (amplifier last). The device's performance features include 24dB amplifier gain (amplifier only), 4.4dB NF at maximum gain (includes attenuator insertion losses), and a high OIP3 level of +41dBm. Each of these features makes the device an ideal VGA for multipath receiver and transmitter applications.

In addition, the device operates from a single +5V supply with full performance, or a +3.3V supply for an enhanced power-savings mode with lower performance. The device is available in a compact 48-pin TQFN package (7mm x 7mm) with an exposed pad. Electrical performance is guaranteed over the extended temperature range, from TC = -40°C to +85°C.

### Analog Attenuator Control

The device integrates two analog attenuators. Each analog attenuator has a 33dB range and is controlled using an external voltage, or through the 3-wire SPI interface using an on-chip 8-bit DAC. See the *Applications Information* section and Table 3 for attenuator programming details. The attenuators can be used for both static and dynamic power control.

Note that when the analog attenuators are controlled by the DACs through the SPI bus, the DAC output voltage shows on A\_VCTL\_1 and A\_VCTL\_2 (pins 39 and 22, respectively). Therefore, in SPI mode, the A\_VCTL\_1 and A\_VCTL\_2 pins must only connect to the resistor and capacitor to ground, as shown in the *Typical Application Circuit*.

## Dual 50MHz to 1000MHz High-Linearity, Serial/Analog-Controlled VGA

**Table 1. Control Logic**

AA_SP	ANALOG ATTENUATOR	D/A CONVERTER
0	Controlled by external control voltage	Disabled
1	Controlled by on-chip DAC	Enabled (DAC output voltage shows on A_VCTL__ pins); DAC uses on-chip voltage reference

**Table 2. Operating Modes**

RESULT	V <sub>CC</sub> (V)	AMP_SET	PD_1	PD_2
All on	5	0	0	0
	3.3	1	0	0
AMP1 off AMP2 on	5	0	1	0
	3.3	1	1	0
AMP1 on AMP2 off	5	0	0	1
	3.3	1	0	1
All off	5	0	1	1
	3.3	1	1	1

### Driver Amplifier

Each path of the device includes a high-performance driver with a fixed gain of 24dB. The driver amplifier circuits are optimized for high linearity for the 50MHz to 1000MHz frequency range.

### Applications Information

#### Operating Modes

The device features an optional +3.3V supply voltage operation with reduced linearity performance. The AMPSET pin needs to be biased accordingly in each mode, as listed in Table 2. In addition, the driver amplifiers can be shut down independently to conserve DC power. See the biasing scheme outlined in Table 2 for details.

#### SPI Interface and Attenuator Settings

The attenuators can be programmed through the 3-wire SPI/MICROWIRE™-compatible serial interface using 5-bit words. Fifty-six bits of data are shifted in MSB first and are framed by  $\overline{CS}$ . The first 28 bits set the first attenuator and the following 28 bits set the second attenuator. When  $\overline{CS}$  is low, the clock is active and data is shifted on the rising edge of the clock. When  $\overline{CS}$  transitions high, the data is latched and the attenuator setting changes (Figure 1). See Table 3 for details on the SPI data format.

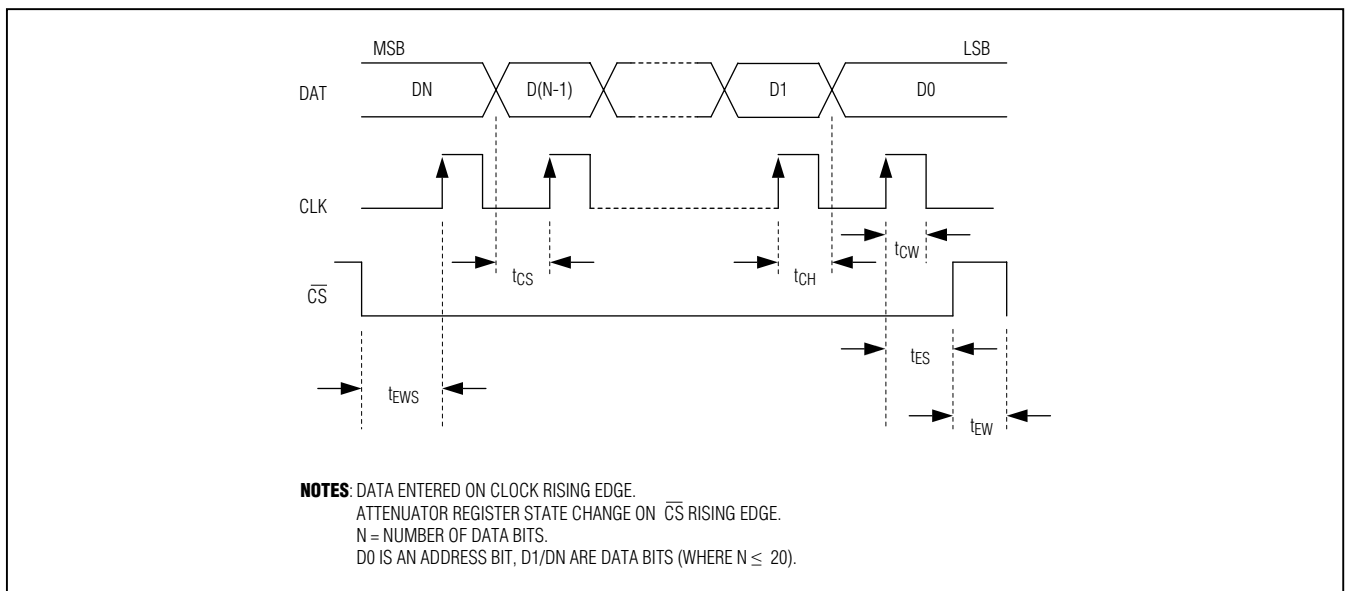

Figure 1. SPI Timing Diagram

MICROWIRE is a trademark of National Semiconductor Corp.

# MAX2064

## ual 50MHz to 1000MHz High-Linearity, Serial/Analog-Controlled VGA

Table 3. SPI Data Format

FUNCTION	BIT	DESCRIPTION
Reserved	D55 (MSB)	Bits D[55:36] are reserved. Set to logic 0.
	D54	
	D53	
	D52	
	D51	
	D50	
	D49	
	D48	
	D47	
	D46	
	D45	
	D44	
	D43	
	D42	
	D41	
	D40	
D39		
D38		
D37		
D36		
On-Chip DAC (Path 2)	D35	Bit 7 (MSB) of on-chip DAC used to program the Path 2 analog attenuator
	D34	Bit 6 of DAC
	D33	Bit 5 of DAC
	D32	Bit 4 of DAC
	D31	Bit 3 of DAC
	D30	Bit 2 of DAC
	D29	Bit 1 of DAC
	D28	Bit 0 (LSB) of DAC



# MAX2064

## Dual 50MHz to 1000MHz High-Linearity, Serial/Analog-Controlled VGA

Table 3. SPI Data Format (continued)

FUNCTION	BIT	DESCRIPTION
Reserved	D27	Bits D[27:8] are reserved. Set to logic 0.
	D26	
	D25	
	D24	
	D23	
	D22	
	D21	
	D20	
	D19	
	D18	
	D17	
	D16	
	D15	
	D14	
	D13	
	D12	
D11		
D10		
D9		
D8		
On-Chip DAC (Path 1)	D7	Bit 7 (MSB) of on-chip DAC used to program the Path 1 analog attenuator
	D6	Bit 6 of DAC
	D5	Bit 5 of DAC
	D4	Bit 4 of DAC
	D3	Bit 3 of DAC
	D2	Bit 2 of DAC
	D1	Bit 1 of DAC
	D0 (LSB)	Bit 0 (LSB) of DAC

# MAX2064

## ual 50MHz to 1000MHz High-Linearity, Serial/Analog-Controlled VGA

### Power-Supply Sequencing

The sequence to be used is:

- 1) Power supply
- 2) Control lines

### Layout Considerations

The pin configuration of the device is optimized to facilitate a very compact physical layout of the device and its associated discrete components. The exposed pad (EP) of the device's 48-pin TQFN-EP package provides a low thermal-resistance path to the die. It is important that

the PCB on which the device is mounted be designed to conduct heat from the EP. In addition, provide the EP with a low inductance path to electrical ground. The EP **MUST** be soldered to a ground plane on the PCB, either directly or through an array of plated via holes. The layout of the PCB should include proper top-layer ground shielding to isolate the amplifier's inputs and outputs from each other. Shielding between the paths (inputs and outputs) is important for channel-to-channel isolation.

**Table 4. Typical Application Circuit Component Values**

DESIGNATION	QTY	DESCRIPTION	COMPONENT SUPPLIER
C1, C5, C6, C8, C12, C13	6	1000pF ceramic capacitors (0402) GRM1555C1H102J	Murata Electronics North America, Inc.
C3, C10	2	150pF ceramic capacitors (0402) GRM1555C1H151J	Murata Electronics North America, Inc.
C4, C7, C11, C14, C16	5	10nF ceramic capacitors (0402) GRM155R71E103K	Murata Electronics North America, Inc.
C15	1	1μF ceramic capacitor (0603) GRM188R71C105K	Murata Electronics North America, Inc.
L1, L2*	2	820nH inductors (1008) Coilcraft 1008CS-821XJLC	Coilcraft, Inc.
R1, R2	2	47.5kΩ resistors (0402)	—
U1	1	48 TQFN-EP (7mm x 7mm) Maxim MAX2064ETM+	Maxim Integrated Products, Inc.

\*Select the inductors to ensure that self-resonance of the inductors is outside the band of operation.

# MAX2064

## Dual 50MHz to 1000MHz High-Linearity, Serial/Analog-Controlled VGA

### Typical Application Circuit

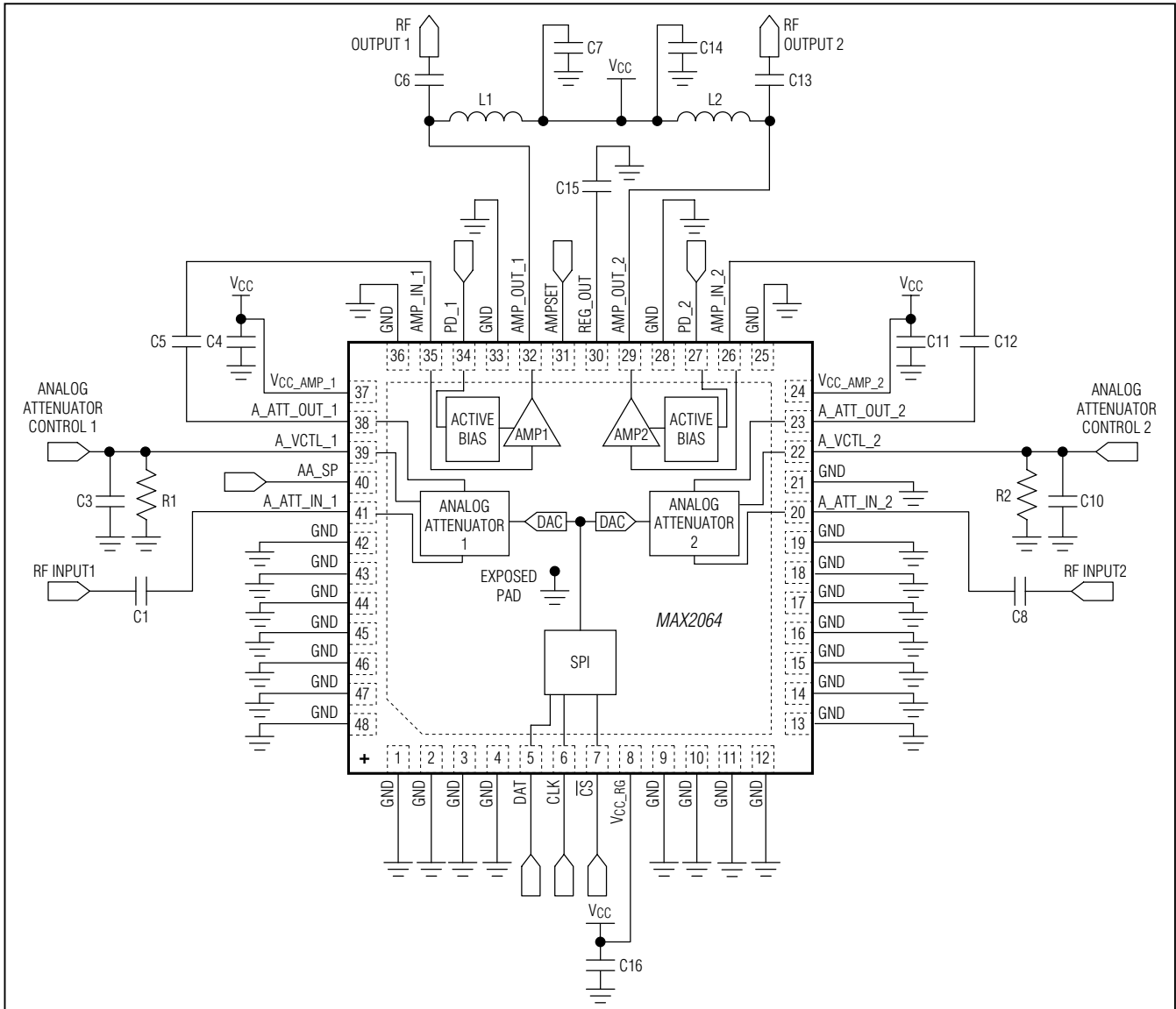

### Chip Information

PROCESS: SiGe BiCMOS

### Package Information

For the latest package outline information and land patterns, go to [www.maximintegrated.com/packages](http://www.maximintegrated.com/packages). Note that a "+", "#", or "-" in the package code indicates RoHS status only. Package drawings may show a different suffix character, but the drawing pertains to the package regardless of RoHS status.

PACKAGE TYPE	PACKAGE CODE	OUTLINE NO.	LAND PATTERN NO.
48 TQFN-EP	T4877+7	<a href="#">21-0144</a>	<a href="#">90-0133</a>

# MAX2064

## ual 50MHz to 1000MHz High-Linearity, Serial/Analog-Controlled VGA

### Revision History

REVISION NUMBER	REVISION DATE	DESCRIPTION	PAGES CHANGED
0	12/10	Initial release	—
1	8/15	Removed military reference from <i>Applications</i>	1



Maxim Integrated cannot assume responsibility for use of any circuitry other than circuitry entirely embodied in a Maxim Integrated product. No circuit patent licenses are implied. Maxim Integrated reserves the right to change the circuitry and specifications without notice at any time. The parametric values (min and max limits) shown in the Electrical Characteristics table are guaranteed. Other parametric values quoted in this data sheet are provided for guidance.