

## Features

- Fully integrated PLL-stabilized VCO
- Frequency range from 850 MHz to 930 MHz
- Single-ended RF output
- FSK through crystal pulling allows modulation from DC to 40 kbit/s
- High FSK deviation possible for wideband data transmission
- ASK achieved by on/off keying of internal power amplifier up to 40 kbit/s
- Wide power supply range from 1.95 V to 5.5 V
- Very low standby current
- On-chip low voltage detector
- High over-all frequency accuracy
- FSK deviation and center frequency independently adjustable
- Adjustable output power range from -11 dBm to +9.5 dBm
- Adjustable current consumption from 5.1 mA to 13.4 mA
- Conforms to EN 300 220 and similar standards
- 10-pin quad flat no lead (QFN) package

## Ordering Code

| Product Code | Temperature Code | Package Code | Option Code | Packing Form Code |
|--------------|------------------|--------------|-------------|-------------------|
| TH72035      | K                | LD           | BAA-000     | TU                |
| TH72035      | K                | LD           | BAA-000     | RE                |

### Legend:

Temperature Code: K for Temperature Range -40°C to 125°C  
 Package Code: LD for QFN double  
 Packing Form: RE for Reel, TU for Tube

Ordering example: TH72035KLD-BAA-000-TU

## Application Examples

- Tire Pressure Monitoring System (TPMS)
- Remote Keyless Entry (RKE)
- Automatic Meter Reading (AMR)
- Alarm and security systems
- Garage door openers
- Home and building automation
- Low-power telemetry
- Wireless access control

## Pin Description

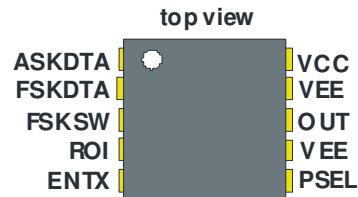

## General Description

The TH72035 FSK/ASK transmitter IC is designed for applications in the European 868 MHz industrial-scientific-medical (ISM) band, according to the EN 300 220 telecommunications standard. It can also be used for any other system with carrier frequencies ranging from 850 MHz to 930 MHz (e.g. for applications in the US 902 to 928 MHz ISM band).

The transmitter's carrier frequency  $f_c$  is determined by the frequency of the reference crystal  $f_{ref}$ . The integrated PLL synthesizer ensures that each RF value, ranging from 850 MHz to 930 MHz, can be achieved. This is done by using a crystal with a reference frequency according to:  $f_{ref} = f_c/N$ , where  $N = 32$  is the PLL feedback divider ratio.

**Document Content**

|           |  |           |
|-----------|--|-----------|
| <b>1</b>  | <b>Theory of Operation</b> .....   | <b>3</b>  |
| 1.1       | General .....  | 3         |
| 1.2       | Block Diagram.....   | 3         |
| <b>2</b>  | <b>Functional Description</b> .....  | <b>3</b>  |
| 2.1       | Crystal Oscillator.....  | 3         |
| 2.2       | FSK Modulation .....   | 4         |
| 2.3       | Crystal Pulling.....   | 4         |
| 2.4       | ASK Modulation .....   | 5         |
| 2.5       | Output Power Selection.....  | 5         |
| 2.6       | Lock Detection .....   | 5         |
| 2.7       | Low Voltage Detection .....  | 5         |
| 2.8       | Mode Control Logic.....  | 6         |
| 2.9       | Timing Diagrams.....   | 6         |
| <b>3</b>  | <b>Pin Definition and Description</b> .....  | <b>7</b>  |
| <b>4</b>  | <b>Electrical Characteristics</b> .....  | <b>8</b>  |
| 4.1       | Absolute Maximum Ratings.....  | 8         |
| 4.2       | Normal Operating Conditions .....  | 8         |
| 4.3       | Crystal Parameters .....   | 8         |
| 4.4       | DC Characteristics .....   | 9         |
| 4.5       | AC Characteristics .....   | 10        |
| 4.6       | Output Power Steps.....  | 10        |
| <b>5</b>  | <b>Typical Operating Characteristics</b> .....   | <b>11</b> |
| 5.1       | DC Characteristics .....   | 11        |
| 5.2       | AC Characteristics .....   | 14        |
| <b>6</b>  | <b>Test Circuit</b> .....  | <b>17</b> |
| 6.1       | Test circuit component list to Fig. 18 .....   | 17        |
| <b>7</b>  | <b>Package Description</b> .....   | <b>18</b> |
| 7.1       | Soldering Information .....  | 18        |
| 7.2       | Recommended PCB Footprints.....  | 18        |
| <b>8</b>  | <b>Standard information regarding manufacturability of Melexis products with different soldering processes</b> ..... | <b>19</b> |
| <b>9</b>  | <b>ESD Precautions</b> .....   | <b>19</b> |
| <b>10</b> | <b>Disclaimer</b> .....  | <b>20</b> |

## 1 Theory of Operation

### 1.1 General

As depicted in Fig.1, the TH72035 transmitter consists of a fully integrated voltage-controlled oscillator (VCO), a divide-by-32 divider (div32), a phase-frequency detector (PFD) and a charge pump (CP). An internal loop filter determines the dynamic behavior of the PLL and suppresses reference spurious signals. A Colpitts crystal oscillator (XOSC) is used as the reference oscillator of a phase-locked loop (PLL) synthesizer. The VCO's output signal feeds the power amplifier (PA). The RF signal power  $P_{out}$  can be adjusted in four steps from  $P_{out} = -11$  dBm to +9.5 dBm, either by changing the value of resistor RPS or by varying the voltage  $V_{PS}$  at pin PSEL. The open-collector output (OUT) can be used either to directly drive a loop antenna or to be matched to a 50Ohm load. Bandgap biasing ensures stable operation of the IC at a power supply range of 1.95 V to 5.5 V.

### 1.2 Block Diagram

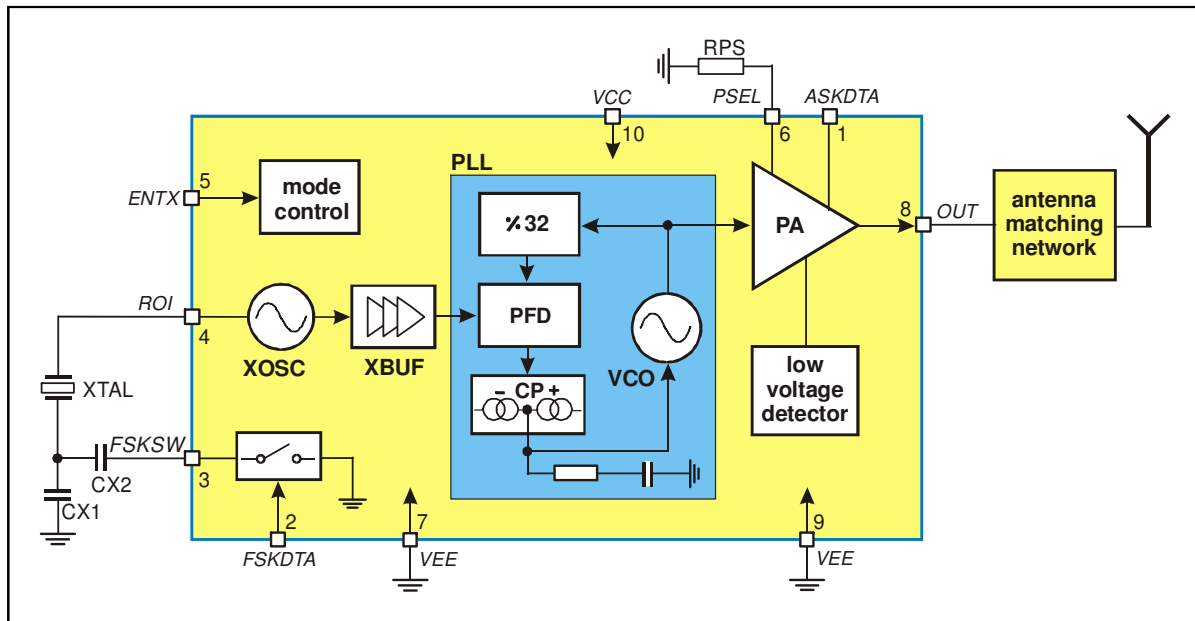

Fig. 1: Block diagram with external components

## 2 Functional Description

### 2.1 Crystal Oscillator

A Colpitts crystal oscillator with integrated functional capacitors is used as the reference oscillator for the PLL synthesizer. The equivalent input capacitance CRO offered by the crystal oscillator input pin ROI is about 18pF. The crystal oscillator is provided with an amplitude control loop in order to have a very stable frequency over the specified supply voltage and temperature range in combination with a short start-up time.

## 2.2 FSK Modulation

FSK modulation can be achieved by pulling the crystal oscillator frequency. A CMOS-compatible data stream applied at the pin FSKDTA digitally modulates the XOSC via an integrated NMOS switch. Two external pulling capacitors CX1 and CX2 allow the FSK deviation  $\Delta f$  and the center frequency  $f_c$  to be adjusted independently. At FSKDTA = 0, CX2 is connected in parallel to CX1 leading to the low-frequency component of the FSK spectrum ( $f_{min}$ ); while at FSKDTA = 1, CX2 is deactivated and the XOSC is set to its high frequency  $f_{max}$ . An external reference signal can be directly AC-coupled to the reference oscillator input pin ROI. Then the transmitter is used without a crystal. Now the reference signal sets the carrier frequency and may also contain the FSK (or FM) modulation.

Fig. 2: Crystal pulling circuitry

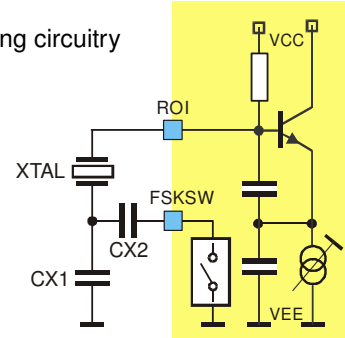

| FSKDTA | Description                                       |
|--------|---|
| 0      | $f_{min} = f_c - \Delta f$ (FSK switch is closed) |
| 1      | $f_{max} = f_c + \Delta f$ (FSK switch is open)   |

## 2.3 Crystal Pulling

A crystal is tuned by the manufacturer to the required oscillation frequency  $f_0$  at a given load capacitance  $CL$  and within the specified calibration tolerance. The only way to pull the oscillation frequency is to vary the effective load capacitance  $CL_{eff}$  seen by the crystal. Figure 3 shows the oscillation frequency of a crystal as a function of the effective load capacitance. This capacitance changes in accordance with the logic level of FSKDTA around the specified load capacitance. The figure illustrates the relationship between the external pulling capacitors and the frequency deviation. It can also be seen that the pulling sensitivity increases with the reduction of  $CL$ . Therefore, applications with a high frequency deviation require a low load capacitance. For narrow band FSK applications, a higher load capacitance could be chosen in order to reduce the frequency drift caused by the tolerances of the chip and the external pulling capacitors.

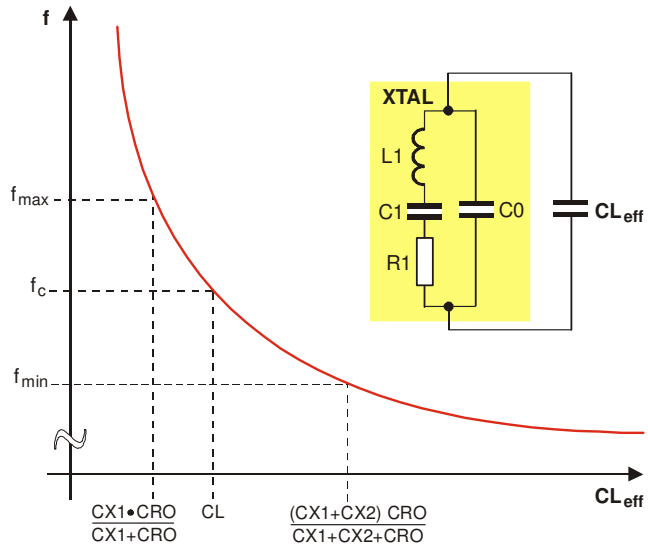

Fig. 3: Crystal pulling characteristic

For ASK applications CX2 can be omitted. Then CX1 has to be adjusted for center frequency.

## 2.4 ASK Modulation

The PLL transmitter can be ASK-modulated by applying a data stream directly at the pin ASKDTA. This turns the internal current sources of the power amplifier on and off and therefore leads to an ASK signal at the output.

| ASKDTA | Description  |
|--------|--|
| 0      | Power amplifier is turned off  |
| 1      | Power amplifier is turned on (according to the selected output power step) |

## 2.5 Output Power Selection

The transmitter is provided with an output power selection feature. There are four predefined output power steps and one off-step accessible via the power selection pin PSEL. A digital power step adjustment was chosen because of its high accuracy and stability. The number of steps and the step sizes as well as the corresponding power levels are selected to cover a wide spectrum of different applications.

The implementation of the output power control logic is shown in figure 4. There are two matched current sources with an amount of about 8  $\mu$ A. One current source is directly applied to the PSEL pin. The other current source is used for the generation of reference voltages with a resistor ladder. These reference voltages are defining the thresholds between the power steps. The four comparators deliver thermometer-coded control signals depending on the voltage level at the pin PSEL. In order to have a certain amount of ripple tolerance in a noisy environment the comparators are provided with a little hysteresis of about 20 mV. With these control signals, weighted current sources of the power amplifier are switched on or off to set the desired output power level (Digitally Controlled Current Source). The LOCK, ASK signal and the output of the low voltage detector are gating this current source. The LOCK, ASK signal and the output of the low voltage detector are gating this current source.

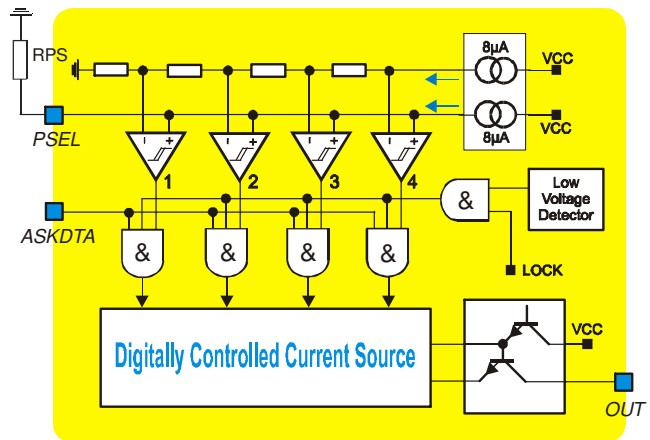

Fig. 4: Block diagram of output power control circuitry

There are two ways to select the desired output power step. First by applying a DC voltage at the pin PSEL, then this voltage directly selects the desired output power step. This kind of power selection can be used if the transmission power must be changed during operation. For a fixed-power application a resistor can be used which is connected from the PSEL pin to ground. The voltage drop across this resistor selects the desired output power level. For fixed-power applications at the highest power step this resistor can be omitted. The pin PSEL is in a high impedance state during the "TX standby" mode.

## 2.6 Lock Detection

The lock detection circuitry turns on the power amplifier only after PLL lock. This prevents from unwanted emission of the transmitter if the PLL is unlocked.

## 2.7 Low Voltage Detection

The supply voltage is sensed by a low voltage detect circuitry. The power amplifier is turned off if the supply voltage drops below a value of about 1.85 V. This is done in order to prevent unwanted emission of the transmitter if the supply voltage is too low.

## 2.8 Mode Control Logic

The mode control logic allows two different modes of operation as listed in the following table. The mode control pin ENTX is pulled-down internally. This guarantees that the whole circuit is shut down if this pin is left floating.

| ENTX | Mode       | Description |
|------|------------|-------------|
| 0    | TX standby | TX disabled |
| 1    | TX active  | TX enable   |

## 2.9 Timing Diagrams

After enabling the transmitter by the ENTX signal, the power amplifier remains inactive for the time  $t_{on}$ , the transmitter start-up time. The crystal oscillator starts oscillation and the PLL locks to the desired output frequency within the time duration  $t_{on}$ . After successful PLL lock, the LOCK signal turns on the power amplifier, and then the RF carrier can be FSK or ASK modulated.

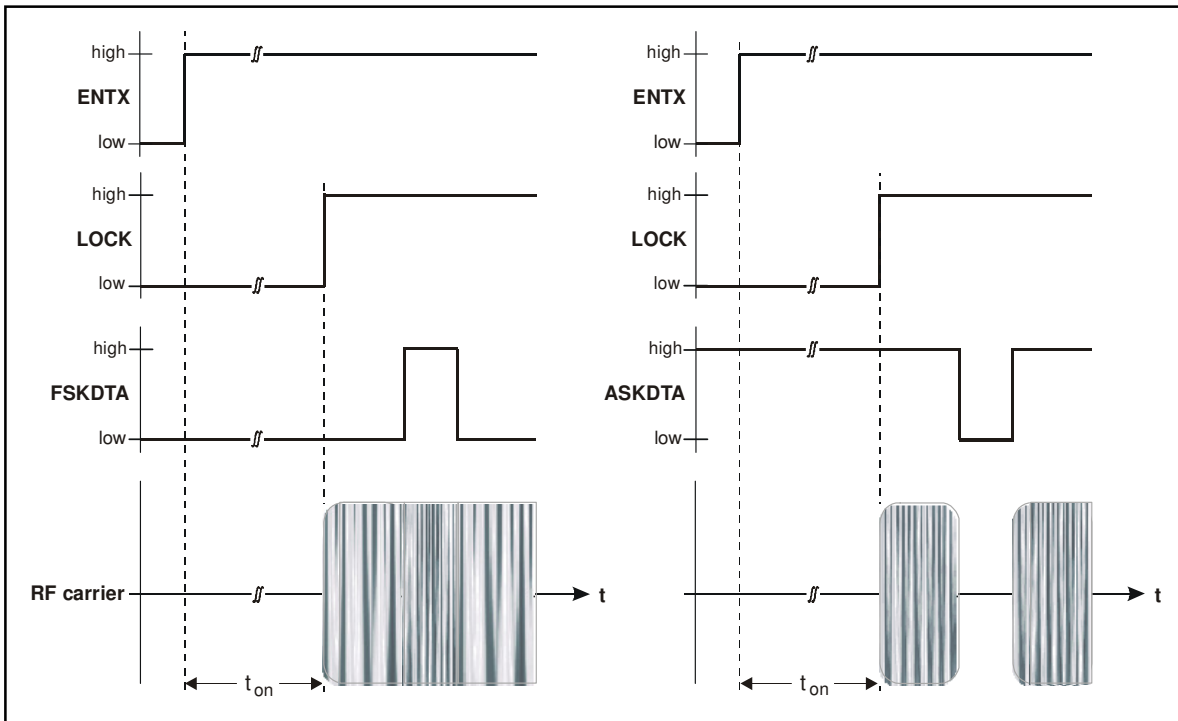
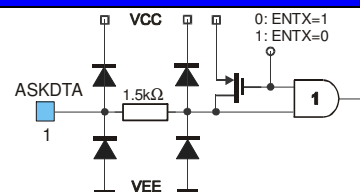
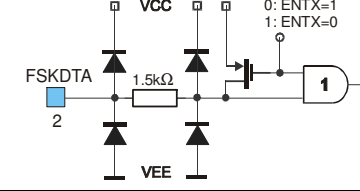
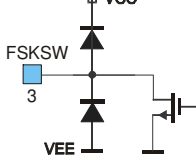
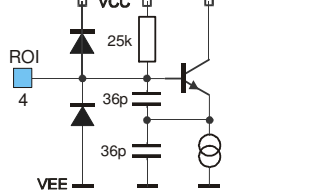
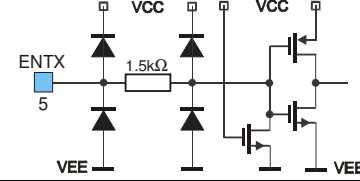
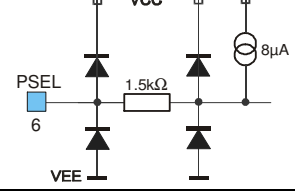
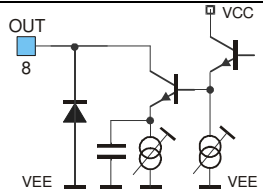

Fig. 5: Timing diagrams for FSK and ASK modulation

### 3 Pin Definition and Description

| Pin No. | Name   | I/O Type   | Functional Schematic   | Description   |
|---------|--------|------------|--|---|
| 1       | ASKDTA | input      |    | <p>ASK data input, CMOS compatible with operation mode dependent pull-up circuit</p> <p>TX standby: no pull-up<br/>TX active: pull up</p>             |
| 2       | FSKDTA | input      |    | <p>FSK data input, CMOS compatible with operation mode dependent pull-up circuit</p> <p>TX standby: no pull-up<br/>TX active: pull up</p>             |
| 3       | FSKSW  | analog I/O |     | XOSC FSK pulling pin, MOS switch  |
| 4       | ROI    | analog I/O |   | XOSC connection to XTAL, Colpitts type crystal oscillator   |
| 5       | ENTX   | input      |  | mode control input, CMOS-compatible with internal pull-down circuit   |
| 6       | PSEL   | analog I/O |   | <p>power select input, high impedance comparator logic</p> <p>TX standby: <math>I_{PSEL} = 0</math><br/>TX active: <math>I_{PSEL} = 8\mu A</math></p> |
| 7       | VEE    | ground     |  | negative power supply   |
| 8       | OUT    | output     |   | power amplifier output, open collector  |
| 9       | VEE    | ground     |  | negative power supply   |
| 10      | VCC    | supply     |  | positive power supply   |

## 4 Electrical Characteristics

### 4.1 Absolute Maximum Ratings

| Parameter               | Symbol     | Condition  | Min  | Max          | Unit |
|-------------------------|------------|--|------|--------------|------|
|                         | $V_{CC}$   |  | 0    | 7.0          | V    |
| Input voltage           | $V_{IN}$   |  | -0.3 | $V_{CC}+0.3$ | V    |
| Storage temperature     | $T_{STG}$  |  | -65  | 150          | °C   |
| Junction temperature    | $T_J$      |  |      | 150          | °C   |
| Thermal Resistance      | $R_{thJA}$ |  |      | 49           | K/W  |
| Power dissipation       | $P_{diss}$ |  |      | 0.12         | W    |
| Electrostatic discharge | $V_{ESD}$  | human body model (HBM) according to CDF-AEC-Q100-002 | ±2.0 |              | kV   |

### 4.2 Normal Operating Conditions

| Parameter               | Symbol     | Condition                                    | Min                | Max                | Unit   |
|-------------------------|------------|--|--------------------|--------------------|--------|
| Supply voltage          | $V_{CC}$   |  | 1.95               | 5.5                | V      |
| Operating temperature   | $T_A$      |  | -40                | 125                | °C     |
| Input low voltage CMOS  | $V_{IL}$   | ENTX, DTA pins                               |                    | $0.3 \cdot V_{CC}$ | V      |
| Input high voltage CMOS | $V_{IH}$   | ENTX, DTA pins                               | $0.7 \cdot V_{CC}$ |                    | V      |
| XOSC frequency          | $f_{ref}$  | set by the crystal                           | 26.6               | 29                 | MHz    |
| VCO frequency           | $f_c$      | $f_c = 32 \cdot f_{ref}$                     | 850                | 930                | MHz    |
| FSK deviation           | $\Delta f$ | depending on CX1, CX2 and crystal parameters | ±2.5               | ±60                | kHz    |
| FSK Data rate           | R          | NRZ  |                    | 40                 | kbit/s |
| ASK Data rate           | R          | NRZ  |                    | 40                 | kbit/s |

### 4.3 Crystal Parameters

| Parameter          | Symbol     | Condition             | Min  | Max | Unit |
|--------------------|------------|-----------------------|------|-----|------|
| Crystal frequency  | $f_0$      | fundamental mode, AT  | 26.6 | 29  | MHz  |
| Load capacitance   | $C_L$      |                       | 10   | 15  | pF   |
| Static capacitance | $C_0$      |                       |      | 7   | pF   |
| Series resistance  | $R_1$      |                       |      | 50  | Ω    |
| Spurious response  | $a_{spur}$ | only required for FSK |      | -10 | dB   |



## 4.4 DC Characteristics

all parameters under normal operating conditions, unless otherwise stated;  
typical values at  $T_A = 23\text{ °C}$  and  $V_{CC} = 3\text{ V}$

| Parameter                                   | Symbol       | Condition                     | Min                | Typ  | Max                | Unit          |
|---|--------------|-------------------------------|--------------------|------|--------------------|---------------|
| <b>Operating Currents</b>                   |              |                               |                    |      |                    |               |
| Standby current                             | $I_{SBY}$    | ENTX=0, $T_A=85\text{ °C}$    |                    | 0.2  | 200                | nA            |
|   |              | ENTX=0, $T_A=125\text{ °C}$   |                    |      | 4                  | $\mu\text{A}$ |
| Supply current in power step 0              | $I_{CC0}$    | ENTX=1                        | 2.5                | 3.9  | 5.7                | mA            |
| Supply current in power step 1              | $I_{CC1}$    | ENTX=1                        | 3.5                | 5.1  | 7.3                | mA            |
| Supply current in power step 2              | $I_{CC2}$    | ENTX=1                        | 4.5                | 6.4  | 8.8                | mA            |
| Supply current in power step 3              | $I_{CC3}$    | ENTX=1                        | 6.2                | 8.6  | 11.4               | mA            |
| Supply current in power step 4              | $I_{CC4}$    | ENTX=1                        | 9.4                | 13.4 | 17.3               | mA            |
| <b>Digital Pin Characteristics</b>          |              |                               |                    |      |                    |               |
| Input low voltage CMOS                      | $V_{IL}$     | ENTX, DTA pins                | -0.3               |      | $0.3 \cdot V_{CC}$ | V             |
| Input high voltage CMOS                     | $V_{IH}$     | ENTX, DTA pins                | $0.7 \cdot V_{CC}$ |      | $V_{CC} + 0.3$     | V             |
| Pull down current<br>ENTX pin               | $I_{PDEN}$   | ENTX=1                        | 0.2                | 2.0  | 20                 | $\mu\text{A}$ |
| Low level input current<br>ENTX pin         | $I_{INLEN}$  | ENTX=0                        |                    |      | 0.02               | $\mu\text{A}$ |
| High level input current<br>DTA pins        | $I_{INHDTA}$ | FSKDTA=1<br>ASKDTA=1          |                    |      | 0.02               | $\mu\text{A}$ |
| Pull up current<br>DTA pins active          | $I_{PUDTAa}$ | FSKDTA=0,<br>ASKDTA=0, ENTX=1 | 0.1                | 1.5  | 12                 | $\mu\text{A}$ |
| Pull up current<br>DTA pins standby         | $I_{PUDTAs}$ | FSKDTA=0,<br>ASKDTA=0, ENTX=0 |                    |      | 0.02               | $\mu\text{A}$ |
| <b>FSK Switch Resistance</b>                |              |                               |                    |      |                    |               |
| MOS switch On resistance                    | $R_{ON}$     | FSKDTA=0<br>ENTX=1            |                    | 20   | 70                 | $\Omega$      |
| MOS switch Off resistance                   | $R_{OFF}$    | FSKDTA=1<br>ENTX=1            | 1                  |      |                    | M $\Omega$    |
| <b>Power Select Characteristics</b>         |              |                               |                    |      |                    |               |
| Power select current                        | $I_{PSEL}$   | ENTX=1                        | 7.0                | 8.6  | 9.9                | $\mu\text{A}$ |
| Power select voltage step 0                 | $V_{PS0}$    | ENTX=1                        |                    |      | 0.035              | V             |
| Power select voltage step 1                 | $V_{PS1}$    | ENTX=1                        | 0.14               |      | 0.24               | V             |
| Power select voltage step 2                 | $V_{PS2}$    | ENTX=1                        | 0.37               |      | 0.60               | V             |
| Power select voltage step 3                 | $V_{PS3}$    | ENTX=1                        | 0.78               |      | 1.29               | V             |
| Power select voltage step 4                 | $V_{PS4}$    | ENTX=1                        | 1.55               |      |                    | V             |
| <b>Low Voltage Detection Characteristic</b> |              |                               |                    |      |                    |               |
| Low voltage detect threshold                | $V_{LVD}$    | ENTX=1                        | 1.75               | 1.85 | 1.95               | V             |

## 4.5 AC Characteristics

all parameters under normal operating conditions, unless otherwise stated;  
typical values at  $T_A = 23\text{ °C}$  and  $V_{CC} = 3\text{ V}$ ; test circuit shown in Fig. 18,  $f_c = 868.3\text{ MHz}$

| Parameter   | Symbol     | Condition                       | Min | Typ | Max               | Unit   |
|---|------------|---------------------------------|-----|-----|-------------------|--------|
| <b>CW Spectrum Characteristics</b>                              |            |                                 |     |     |                   |        |
| Output power in step 0 (Isolation in off-state)                 | $P_{off}$  | ENTX=1                          |     |     | -70               | dBm    |
| Output power in step 1  | $P_1$      | ENTX=1                          | -13 | -12 | -11 <sup>1)</sup> | dBm    |
| Output power in step 2  | $P_2$      | ENTX=1                          | -4  | -3  | -2 <sup>1)</sup>  | dBm    |
| Output power in step 3  | $P_3$      | ENTX=1                          | 1   | 2.5 | 3.5 <sup>1)</sup> | dBm    |
| Output power in step 4  | $P_4$      | ENTX=1                          | 4   | 7.5 | 9.5 <sup>1)</sup> | dBm    |
| Phase noise   | $L(f_m)$   | @ 200kHz offset                 |     | -87 | -82               | dBc/Hz |
| Spurious emissions according to EN 300 220-1 (2000.09) table 13 | $P_{spur}$ | 47MHz < f < 74MHz               |     |     | -54               | dBm    |
|   |            | 87.5MHz < f < 118MHz            |     |     |                   |        |
|   |            | 174MHz < f < 230MHz             |     |     |                   |        |
|   |            | 470MHz < f < 862MHz             |     |     |                   |        |
|   |            | B=100kHz                        |     |     |                   |        |
|   |            | f < 1GHz, B=100kHz              |     |     | -36               | dBm    |
|   |            | f > 1GHz, B=1MHz                |     |     | -30               | dBm    |
| <b>Start-up Parameters</b>                                      |            |                                 |     |     |                   |        |
| Start-up time   | $t_{on}$   | from standby to transmit mode   |     | 0.6 | 1                 | ms     |
| <b>Frequency Stability</b>                                      |            |                                 |     |     |                   |        |
| Frequency stability vs. supply voltage                          | $df_{VCC}$ |                                 |     |     | ±3                | ppm    |
| Frequency stability vs. temperature                             | $df_{TA}$  | crystal at constant temperature |     |     | ±10               | ppm    |
| Frequency stability vs. variation range of $C_{RO}$             | $df_{CRO}$ |                                 |     |     | ±20               | ppm    |

1) output matching network tuned for 5V supply

## 4.6 Output Power Steps

| Power step | 0   | 1  | 2  | 3   | 4             |
|------------|-----|----|----|-----|---------------|
| RPS / kΩ   | < 3 | 22 | 56 | 120 | not connected |

## 5 Typical Operating Characteristics

### 5.1 DC Characteristics

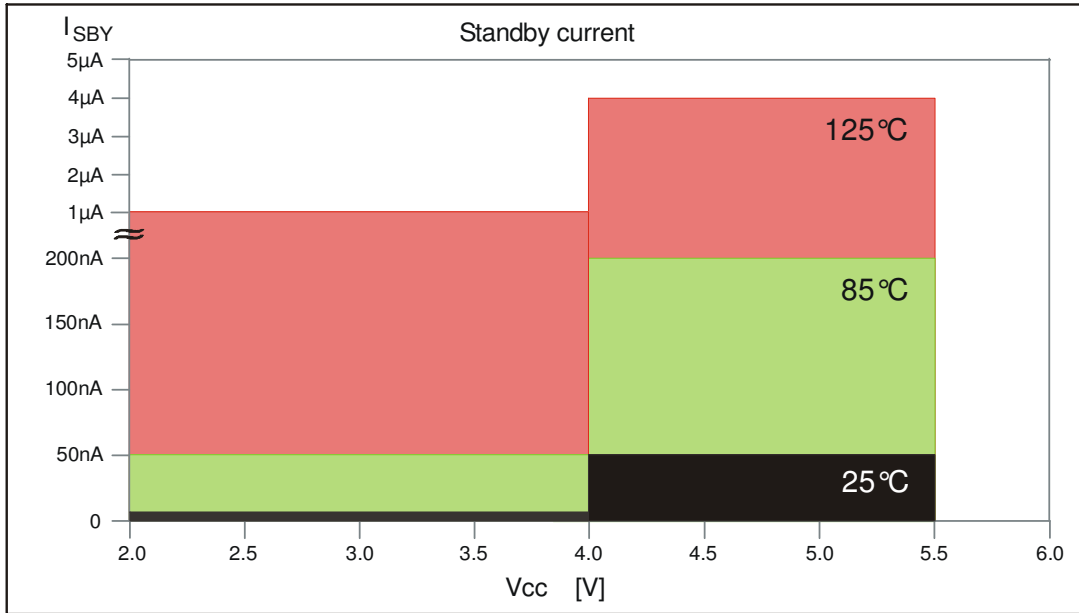

Fig. 6: Standby current limits

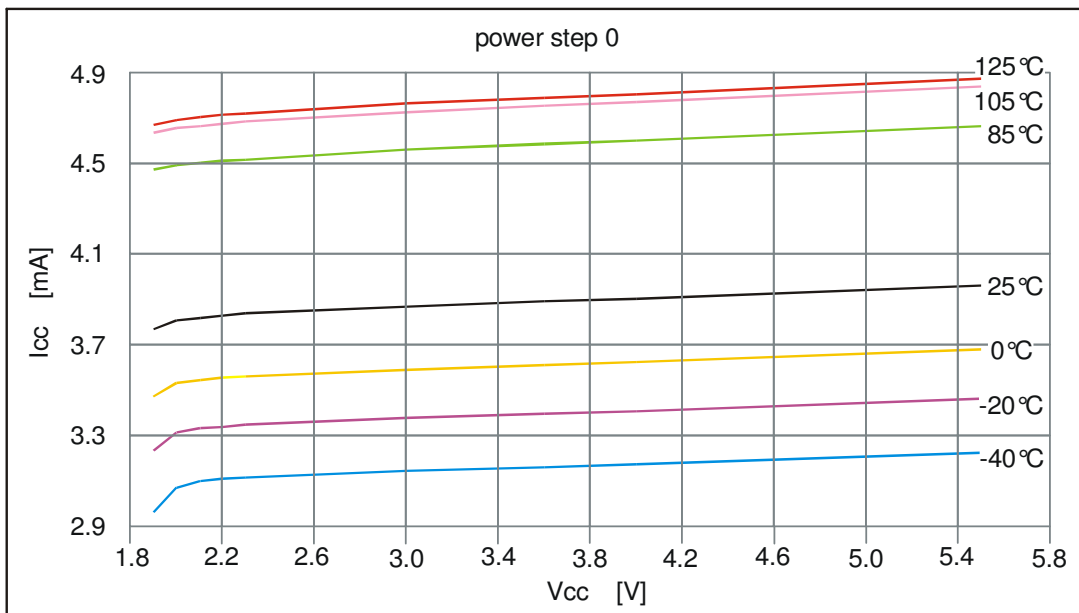

Fig. 7: Supply current in power step 0

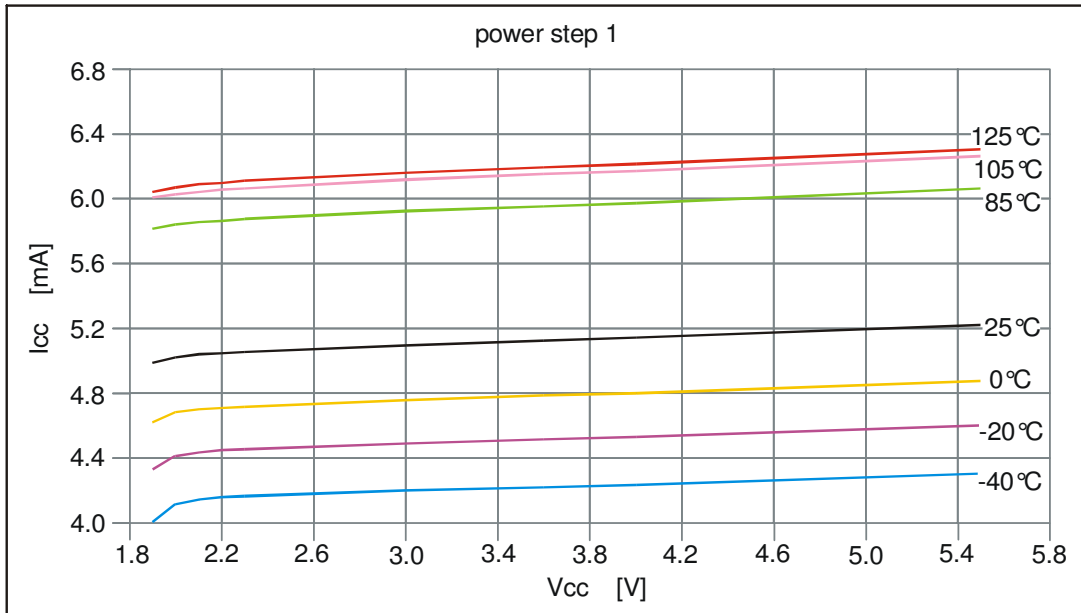

Fig. 8: Supply current in power step 1

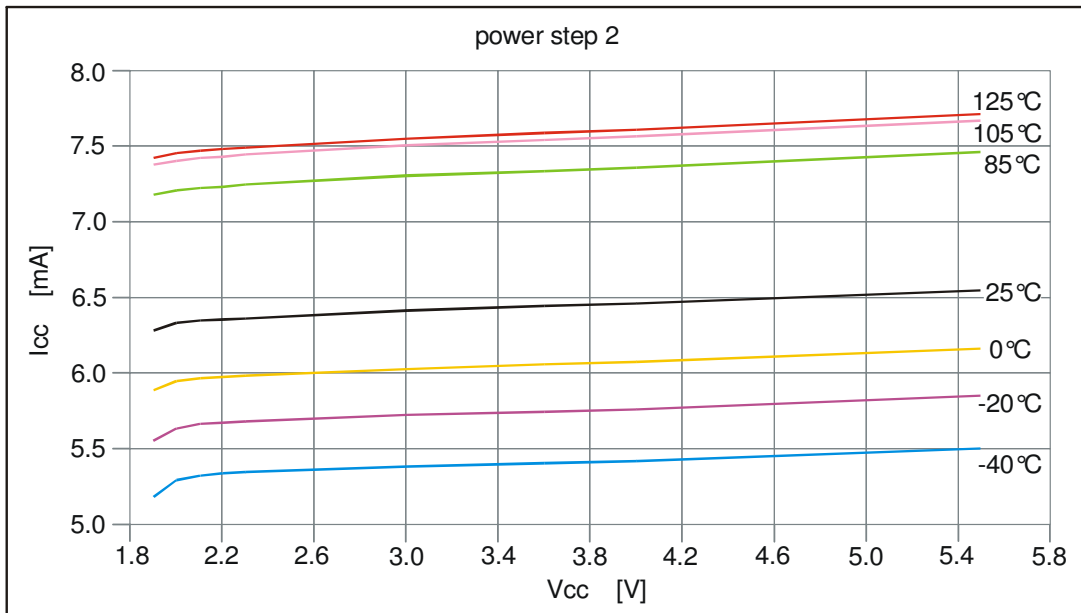

Fig. 9: Supply current in power step 2

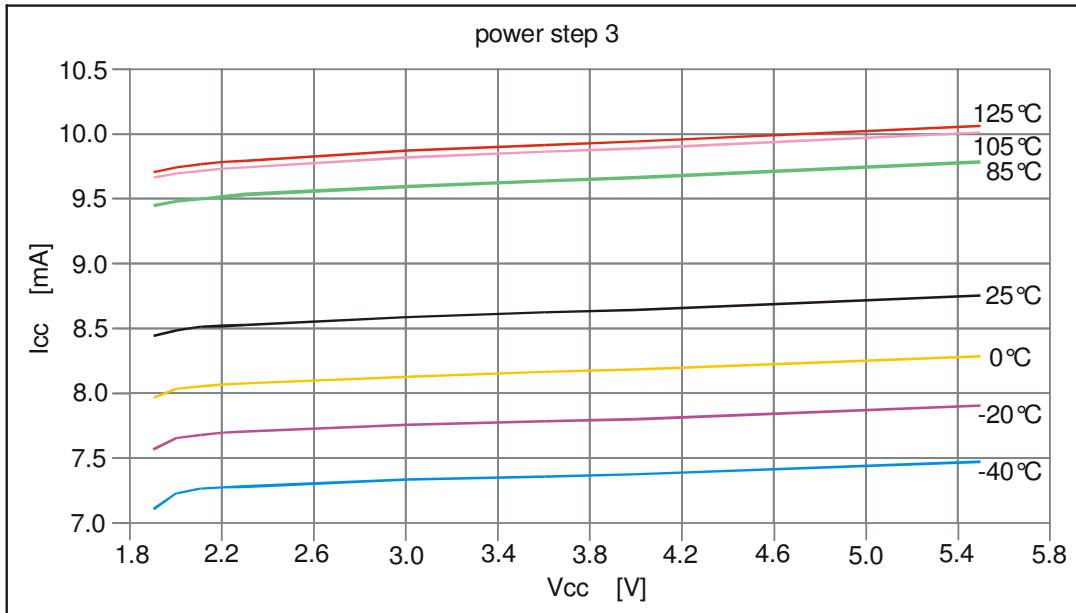

Fig. 10: Supply current in power step 3

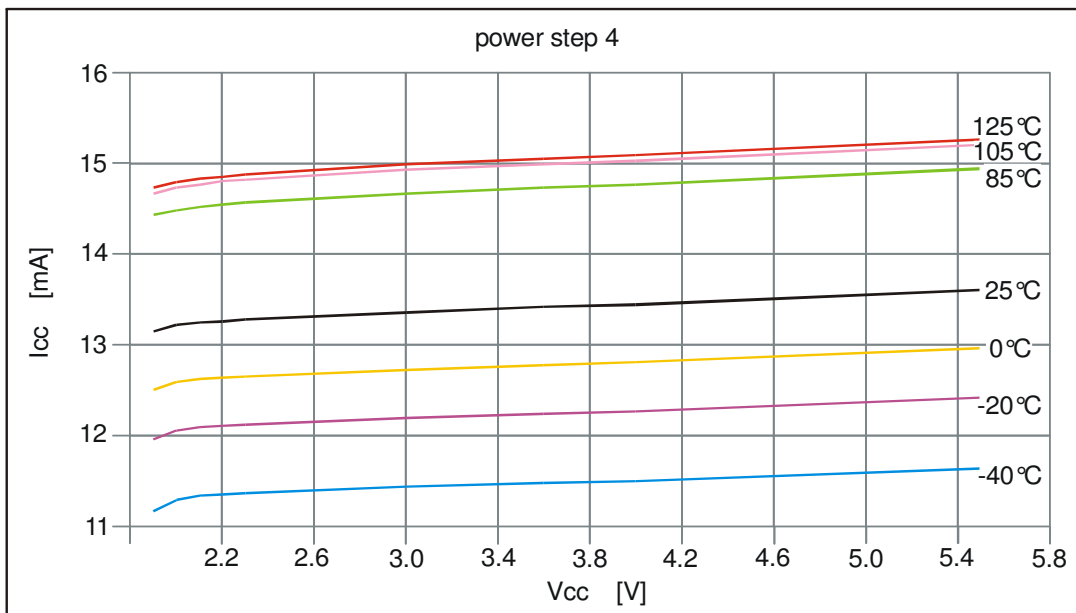

Fig. 11: Supply current in power step 4

**5.2 AC Characteristics**

- Data according to test circuit in Fig. 18 (868.3MHz)

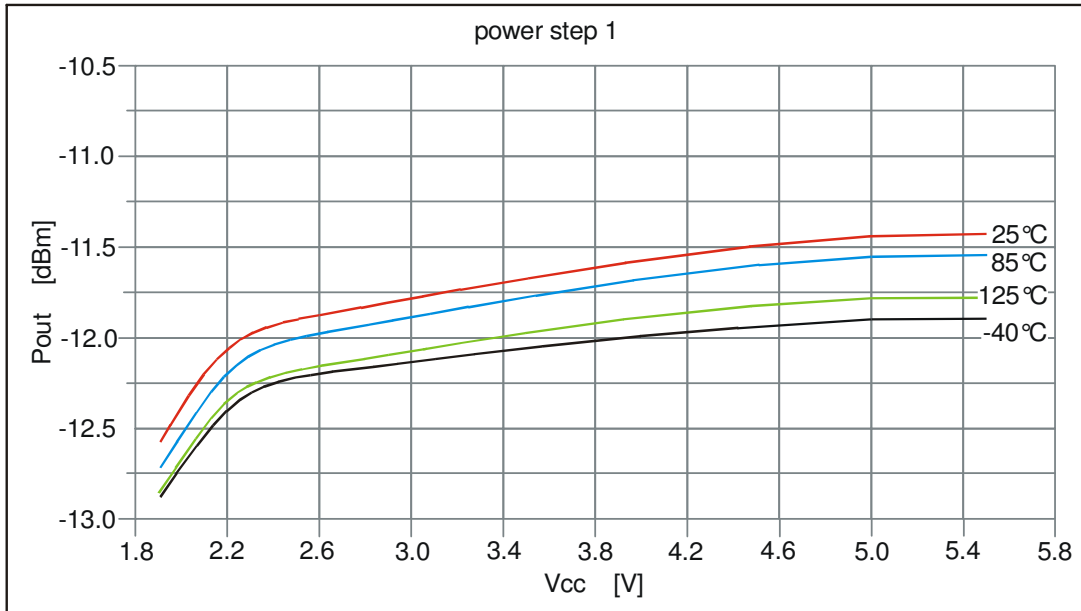

Fig. 12: Output power in step 1

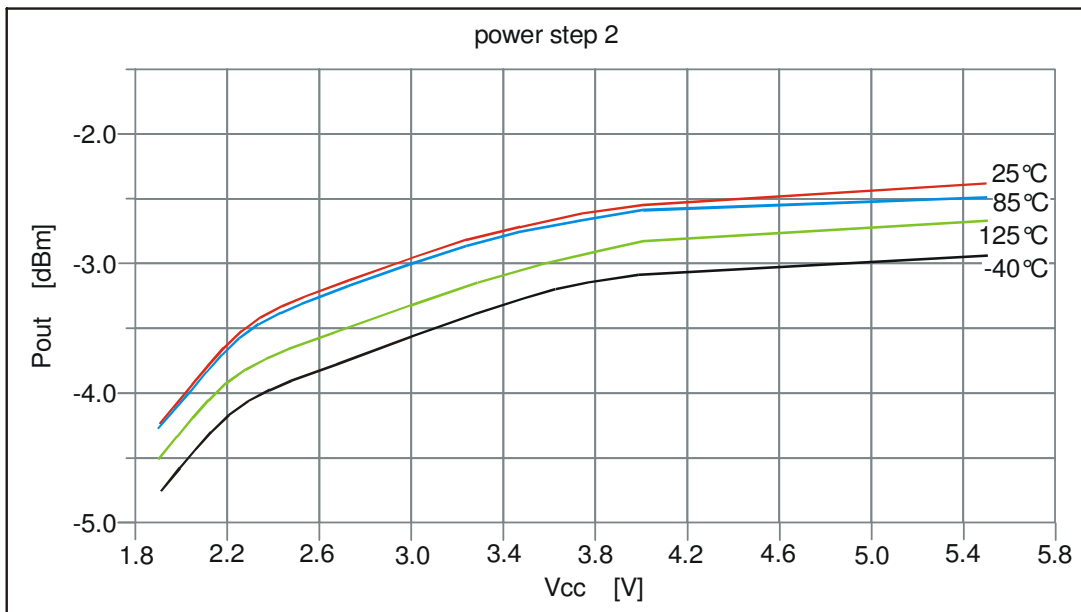

Fig. 13: Output power in step 2

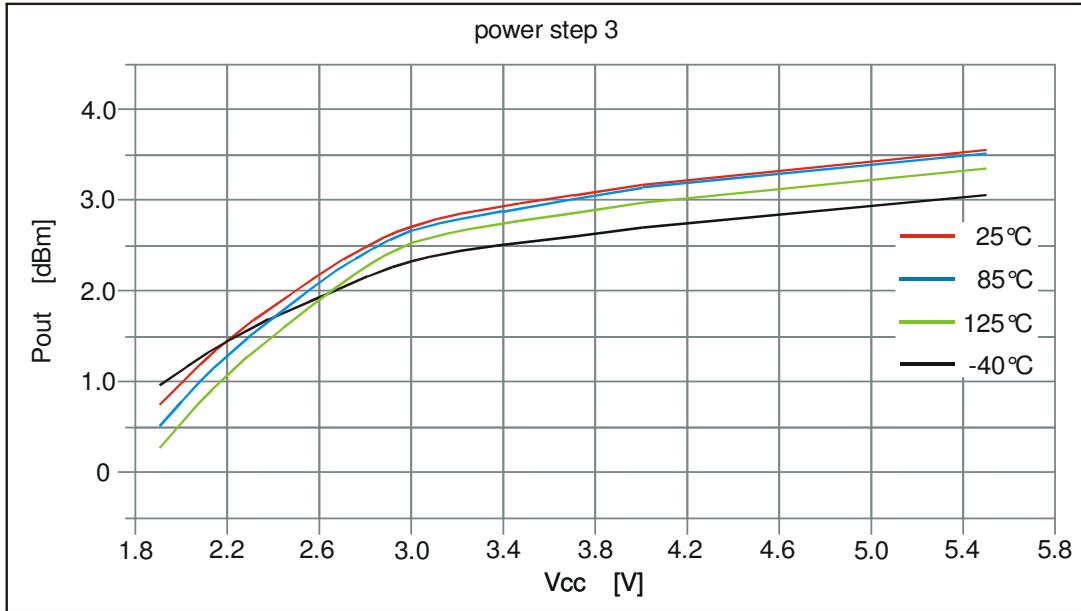

Fig. 14: Output power in step 3

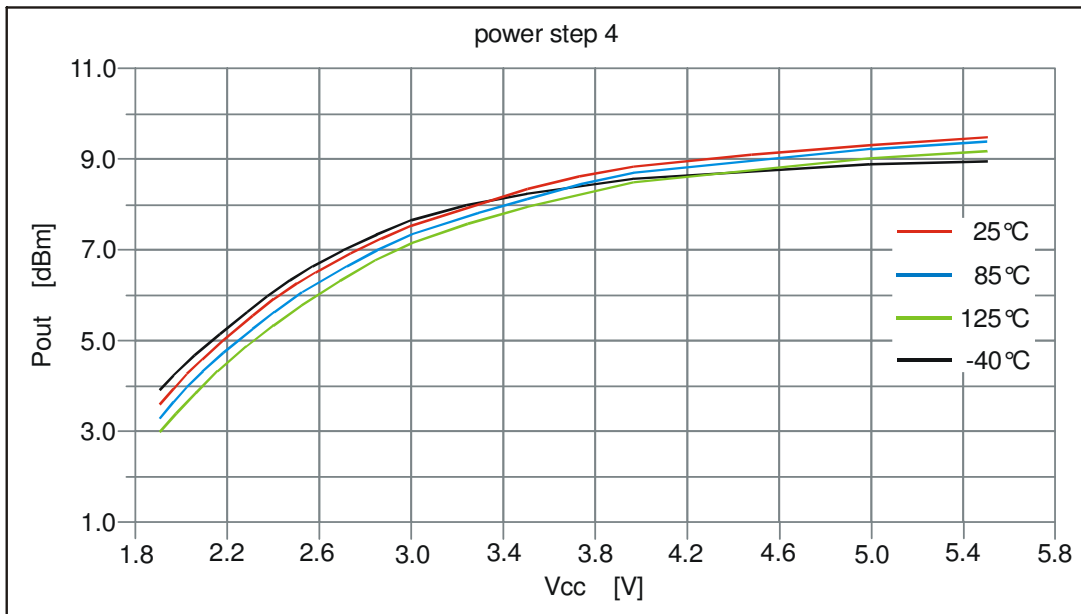

Fig. 15: Output power in step 4

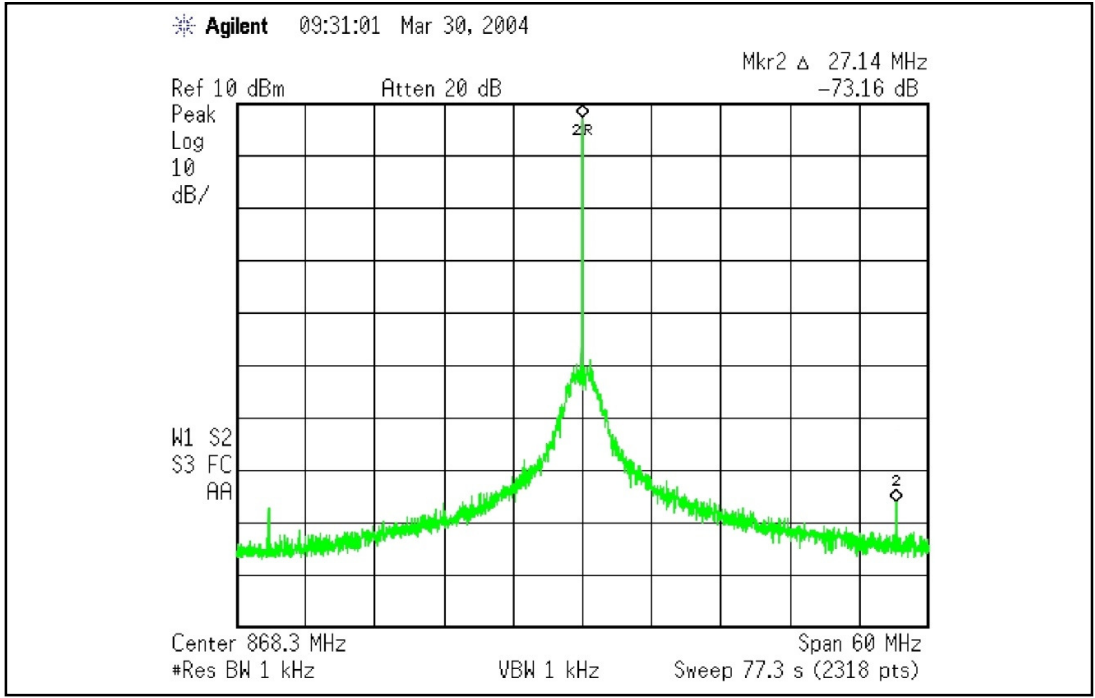

Fig.16: RF output signal with PLL reference spurs

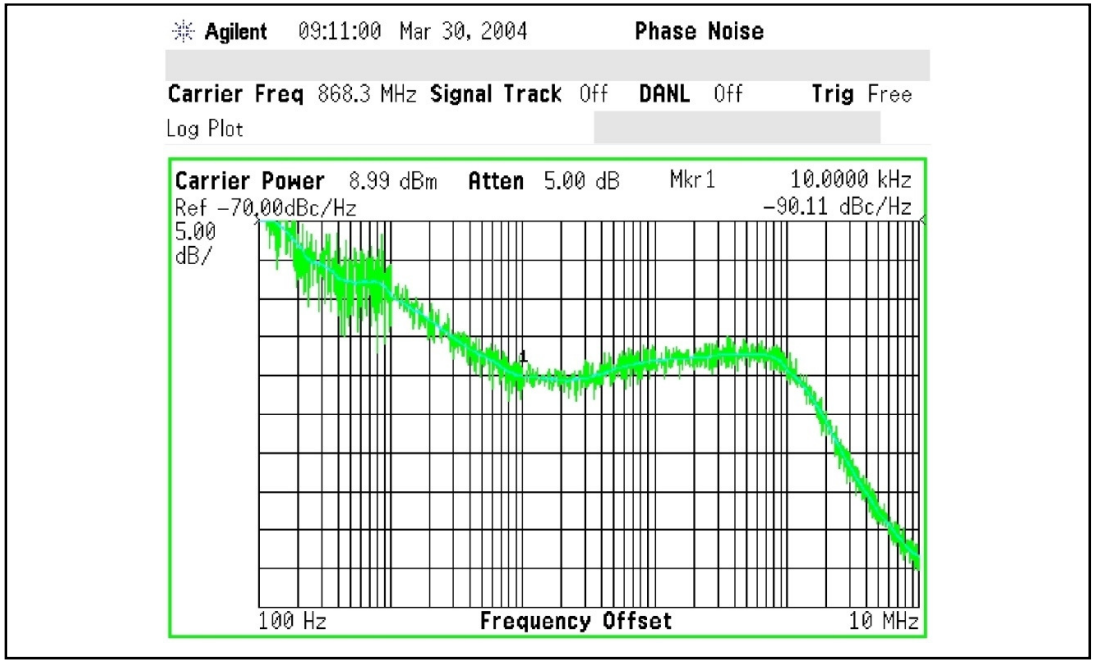

Fig.17: Single sideband phase noise



## 6 Test Circuit

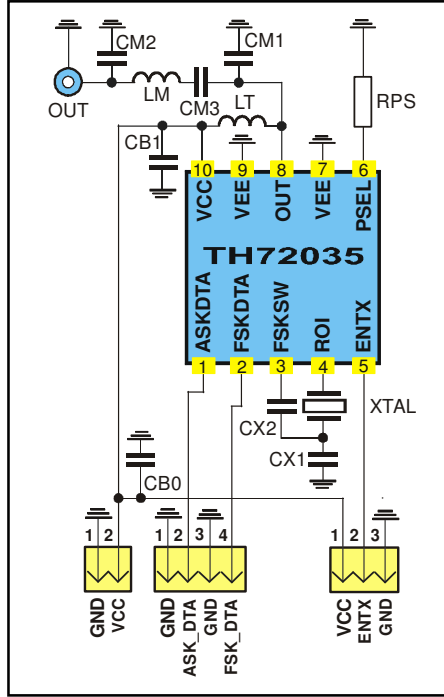

Fig. 18: Test circuit for FSK and ASK with 50  $\Omega$  matching network

### 6.1 Test circuit component list to Fig. 18

| Part    | Size   | Value @ 868.3 MHz | Value @ 915 MHz | Tolerance                                  | Description   |
|---------|--------|-------------------|-----------------|--|---|
| CM1     | 0805   | 1.8 pF            | 2.2 pF          | $\pm 5\%$                                  | impedance matching capacitor  |
| CM2     | 0805   | 5.6 pF            | 5.6 pF          | $\pm 5\%$                                  | impedance matching capacitor  |
| CM3     | 0805   | 68 pF             | 68 pF           | $\pm 5\%$                                  | impedance matching capacitor  |
| LM      | 0805   | 12 nH             | 10 nH           | $\pm 5\%$                                  | impedance matching inductor, note 2   |
| LT      | 0805   | 15 nH             | 10 nH           | $\pm 5\%$                                  | output tank inductor, note 2  |
| CX1_FSK | 0805   | 18 pF             | 18 pF           | $\pm 5\%$                                  | XOSC FSK capacitor ( $\Delta f = \pm 20$ kHz), note 1                             |
| CX1_ASK | 0805   | 27 pF             | 27 pF           | $\pm 5\%$                                  | XOSC ASK capacitor, trimmed to $f_c$ , note 1                                     |
| CX2     | 0805   | 10 pF             | 10 pF           | $\pm 5\%$                                  | XOSC capacitor ( $\Delta f = \pm 20$ kHz), note 1 only needed for FSK             |
| RPS     | 0805   | see section 4.6   |                 | $\pm 5\%$                                  | power-select resistor   |
| CB0     | 0805   | 220 nF            |                 | $\pm 20\%$                                 | de-coupling capacitor   |
| CB1     | 0805   | 330 pF            |                 | $\pm 10\%$                                 | de-coupling capacitor   |
| XTAL    | HC49/S | 27.13438 MHz      | 28.59375 MHz    | $\pm 30$ ppm calibr.<br>$\pm 30$ ppm temp. | fundamental wave crystal, $C_L = 12$ pF, $C_{0, max} = 7$ pF, $R_1 = 40$ $\Omega$ |

**Note 1:** value depending on crystal parameters

**Note 2:** for high-power applications high-Q wire-wound inductors should be used

## 7 Package Description

The device is RoHS compliant.

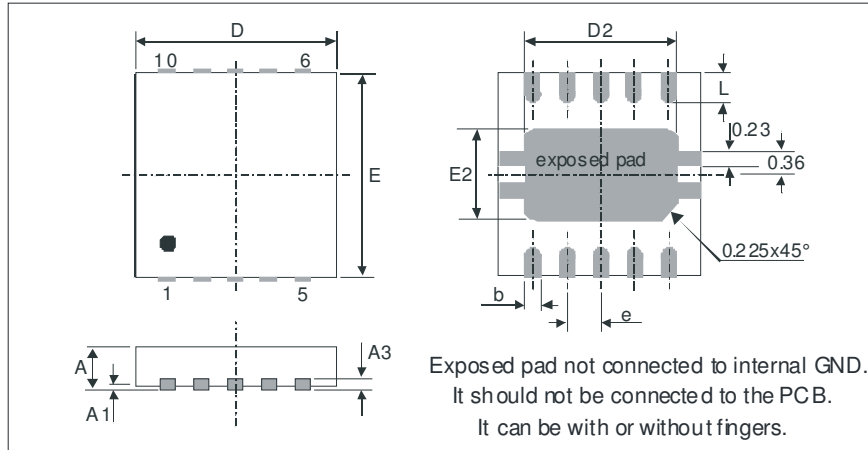

Fig. 7: 10L QFN 3x3 Dual

| all Dimensions in mm   |       |       |        |       |        |       |        |        |        |        |
|------------------------|-------|-------|--------|-------|--------|-------|--------|--------|--------|--------|
|                        | D     | E     | D2     | E2    | A      | A1    | A3     | L      | e      | b      |
| min                    | 2.85  | 2.85  | 2.23   | 1.49  | 0.80   | 0     | 0.20   | 0.3    | 0.50   | 0.18   |
| max                    | 3.15  | 3.15  | 2.48   | 1.74  | 1.00   | 0.05  | 0.20   | 0.5    | 0.50   | 0.30   |
| all Dimensions in inch |       |       |        |       |        |       |        |        |        |        |
|                        | D     | E     | D2     | E2    | A      | A1    | A3     | L      | e      | b      |
| min                    | 0.112 | 0.112 | 0.0878 | 0.051 | 0.0315 | 0     | 0.0079 | 0.0118 | 0.0197 | 0.0071 |
| max                    | 0.124 | 0.124 | 0.0976 | 0.055 | 0.0393 | 0.002 | 0.0079 | 0.0197 | 0.0197 | 0.0118 |

### 7.1 Soldering Information

- The device is qualified for MSL1 with soldering peak temperature 260 deg C according to JEDEC J-STD-20.

### 7.2 Recommended PCB Footprints

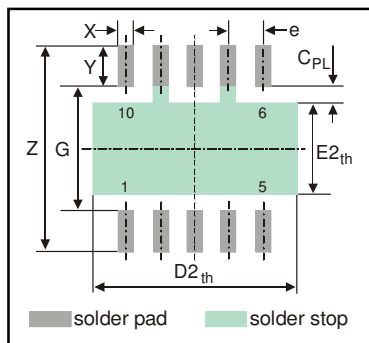

| all Dimensions in mm   |        |        |                  |                  |        |        |                 |        |
|------------------------|--------|--------|------------------|------------------|--------|--------|-----------------|--------|
|                        | Z      | G      | D2 <sub>th</sub> | E2 <sub>th</sub> | X      | Y      | C <sub>PL</sub> | e      |
| min                    | 3.55   | 1.9    | 3.2              | 1.3              | 0.25   | 0.7    | 0.3             | 0.5    |
| max                    | 3.90   | 2.3    | 3.6              | 1.7              | 0.30   | 1.0    | 0.5             | 0.5    |
| all Dimensions in inch |        |        |                  |                  |        |        |                 |        |
|                        | Z      | G      | D2 <sub>th</sub> | E2 <sub>th</sub> | X      | Y      | C <sub>PL</sub> | e      |
| min                    | 0.1398 | 0.0748 | 0.1260           | 0.0512           | 0.0098 | 0.0276 | 0.0591          | 0.0197 |
| max                    | 0.1535 | 0.0906 | 0.1417           | 0.0669           | 0.0118 | 0.0394 | 0.0197          | 0.0197 |

Fig. 8: PCB land pattern style

## **8 Standard information regarding manufacturability of Melexis products with different soldering processes**

Our products are classified and qualified regarding soldering technology, solderability and moisture sensitivity level according to following test methods:

### **Reflow Soldering SMD's (Surface Mount Devices)**

- IPC/JEDEC J-STD-020  
Moisture/Reflow Sensitivity Classification for Nonhermetic Solid State Surface Mount Devices (classification reflow profiles according to table 5-2)
- EIA/JEDEC JESD22-A113  
Preconditioning of Nonhermetic Surface Mount Devices Prior to Reliability Testing (reflow profiles according to table 2)

### **Wave Soldering SMD's (Surface Mount Devices) and THD's (Through Hole Devices)**

- EN60749-20  
Resistance of plastic- encapsulated SMD's to combined effect of moisture and soldering heat
- EIA/JEDEC JESD22-B106 and EN60749-15  
Resistance to soldering temperature for through-hole mounted devices

### **Iron Soldering THD's (Through Hole Devices)**

- EN60749-15  
Resistance to soldering temperature for through-hole mounted devices

### **Solderability SMD's (Surface Mount Devices) and THD's (Through Hole Devices)**

- EIA/JEDEC JESD22-B102 and EN60749-21  
Solderability

For all soldering technologies deviating from above mentioned standard conditions (regarding peak temperature, temperature gradient, temperature profile etc) additional classification and qualification tests have to be agreed upon with Melexis.

The application of Wave Soldering for SMD's is allowed only after consulting Melexis regarding assurance of adhesive strength between device and board.

Melexis is contributing to global environmental conservation by promoting **lead free** solutions. For more information on qualifications of **RoHS** compliant products (RoHS = European directive on the Restriction Of the use of certain Hazardous Substances) please visit the quality page on our website:

<http://www.melexis.com/quality.aspx>

## **9 ESD Precautions**

Electronic semiconductor products are sensitive to Electro Static Discharge (ESD). Always observe Electro Static Discharge control procedures whenever handling semiconductor products.

## **10 Disclaimer**

Devices sold by Melexis are covered by the warranty and patent indemnification provisions appearing in its Term of Sale. Melexis makes no warranty, express, statutory, implied, or by description regarding the information set forth herein or regarding the freedom of the described devices from patent infringement. Melexis reserves the right to change specifications and prices at any time and without notice. Therefore, prior to designing this product into a system, it is necessary to check with Melexis for current information. This product is intended for use in normal commercial applications. Applications requiring extended temperature range, unusual environmental requirements, or high reliability applications, such as military, medical life-support or life-sustaining equipment are specifically not recommended without additional processing by Melexis for each application.

The information furnished by Melexis is believed to be correct and accurate. However, Melexis shall not be liable to recipient or any third party for any damages, including but not limited to personal injury, property damage, loss of profits, loss of use, interrupt of business or indirect, special incidental or consequential damages, of any kind, in connection with or arising out of the furnishing, performance or use of the technical data herein. No obligation or liability to recipient or any third party shall arise or flow out of Melexis' rendering of technical or other services.

© 2012 Melexis NV. All rights reserved.

For the latest version of this document, go to our website at  
**[www.melexis.com](http://www.melexis.com)**

Or for additional information contact Melexis Direct:

|  |  |
|--|--|
| <b>Europe, Africa, Asia:</b>   | <b>America:</b>  |
| Phone: +32 1367 0495   | Phone: +1 248 306 5400   |
| E-mail: <a href="mailto:sales_europe@melexis.com">sales_europe@melexis.com</a> | E-mail: <a href="mailto:sales_usa@melexis.com">sales_usa@melexis.com</a> |

ISO/TS 16949 and ISO14001 Certified