

Table of contents

1. Introduction.....	2
2. Contents of the MLX81200 SW Development kit	3
2.1. Hardware.....	3
2.2. Software	5
3. How to use the MLX81200 SW Development kit.....	6
4. The Software Kit.....	7
4.1. Software Evaluation flow	7
4.2. The installation of the Software Kit	9
5. Hardware Kit.....	11
5.1. Configuration	11
5.2. General.....	12
5.3. Evaluation board.....	12
6. Quick start up	18
6.1. Using the C flow	18
6.2. Programming a HEX file to the FLASH.....	20
7. MLX81200 Software configuration tool (SCT)	23
7.1. General.....	23
7.2. Locate the demokit firmware sources and load the configuration	24
7.3. Configure the demokit firmware	25
7.4. Save, compile and flash the firmware	27
8. BLDC DemoKit PC program	30
8.1. General.....	30
8.2. Main window	31
8.3. Control Load window	33
8.4. Control Debug window	34
8.5. PID controller and PC program.....	34
9. Appendix.....	35
9.1. Schematics of the Evaluation Board.....	35
9.2. Schematic of the Evaluation Board – Part 2 Programmer Interface	36
9.3. Schematic of the Power Board.....	37
10. History record.....	38
11. Disclaimer.....	39

1. Introduction



This document is intended to give a brief introduction of the different parts of the SW Development kit for the ASSP MLX81200. The aim of this document is to support a fast start up with this kit. Besides this document, several other important documents are necessary for a deeper understanding of more detailed development issues.



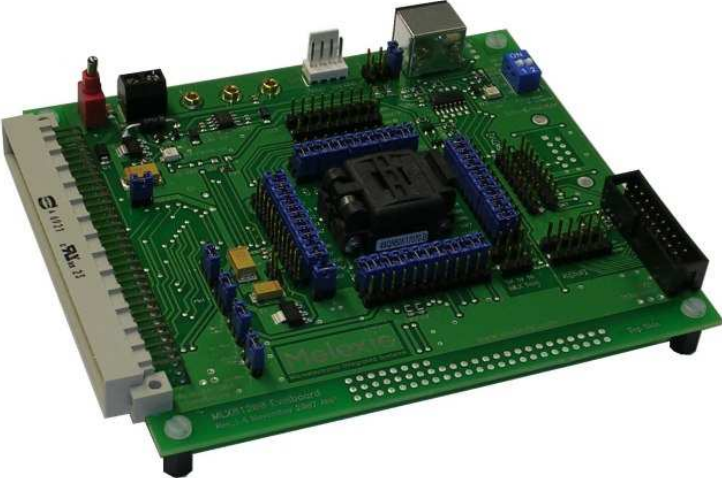

The most important documents related to the MLX81200 are:

MLX81200 Datasheet	-detailed description of the chip with all functions and features
MLX82001_Product_Specification	-MelexCM Datasheet and underlying documentation of different blocks included in the MLX82001
Melexis development system	-MLX Assembler, Linker, Obgen, Tabgen description
GNU C-Compiler GCC	-GCC User's Manual, incl. AS, LD and Getting Started Doc
Melexis emulator (flash programming SW)	-description of the Emulator
Melexis emulator SW	
Mlx16 C-Debugger	-Debugger User's Manual
Mlx16 CPU Simulator	-description of the Simulator
Mlx16X8 Data book	-explanation of the Mlx16X8 microcontroller core and the instruction set
Melexis Lin Master documentation	-description of the Melexis USB LIN Master
MelexCM LIN API (including required SW files)	-detailed description of the MelexCM LIN API
MLX81200 BLDC Demo Kit firmware	-MLX81200_SWDesignDescription_x.pdf
AppNote_MLX81100_MLX81200_Reflashing_on_module_x.pdf	
AppNote_Flash_over_pin_LIN_x.pdf	

2. Contents of the MLX81200 SW Development kit

2.1. Hardware

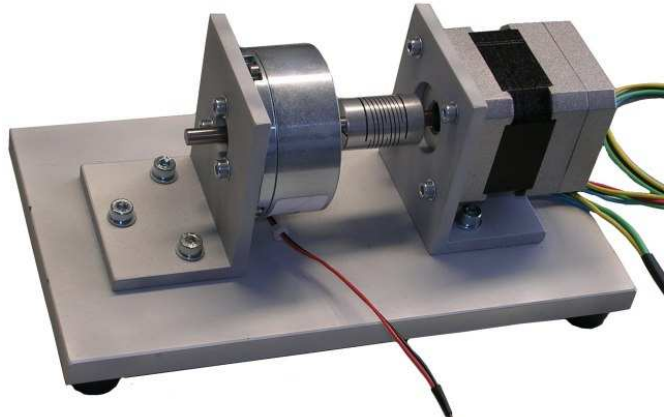
Part	Picture
<p>MLX81200</p>	 <p>A small, square, black integrated circuit chip with gold pins. The chip is labeled with 'MLX81200A', 'E_04270', and '0643'.</p>
<p>Evaluation board</p>	 <p>A green printed circuit board (PCB) populated with various electronic components. It features a central black integrated circuit, several blue headers, a USB connector, and a red potentiometer. The board is mounted on four black standoffs.</p>
<p>Power board</p>	 <p>A green printed circuit board (PCB) designed for power regulation. It features a large blue electrolytic capacitor, several black integrated circuits, and various passive components. The board is populated with a Melexis MLX81200 chip. It has a multi-pin connector on the right side and is mounted on four black standoffs.</p>

<p>USB LIN Master</p>	 <p>A black rectangular device with a blue label that reads "Melexis USB Lin Master version 1.0". The label also lists "PC connected", "PC communication", "M2S message", "S2M message", and "Vbus". At the bottom of the label, it shows "Vbat LIN GND" and "Melexis lin LIN".</p>
<p>Mini E-MLX Emulator</p>	 <p>A small, black, rectangular device with a blue label that reads "Mini E-MLX" and "Melexis". It has a yellow rubber band around its top edge.</p>
<p>BLDC Motor and hysteresis brake</p>	 <p>A mechanical assembly consisting of a silver BLDC motor mounted on a grey metal base. A hysteresis brake is attached to the motor's shaft. Several colored wires (green, yellow, red, black) are connected to the assembly.</p>
<p>Hysteresis brake control board</p>	 <p>A green printed circuit board (PCB) with various electronic components. It features a Melexis logo, a "MLX81200" chip, and several blue potentiometers. Labels on the board include "Hysteresis Brake control", "On/Off", "Down", and "Up".</p>

Tbl. 1 Contents Hardware

2.2. Software

Part	Function	Installation file
Mlx16 Simulator/Emulator	Simulator/Emulator PC Software	Mlx16Setup_x_xx_x.exe
Mlx81200x.mmf	Configuration file for Simulator/Emulator and Flash Programmer	Mlx81200Conf_x_x_x.msi
E-mlx MM/Mini E-MLX Emulator	Emulator Software and hardware driver	EmlxSetup_x_x_x.msi
Mlx16 Interactive C Debugger	Melexis C Debugger	MDC_Setup_x_x_x.exe
Flash Programmer Software for E-mlx MM and Mini E-MLX	Programming software for Flash memory	EMlxMMProgSetup_x_x_xx.msi
Gnu Tool chain	Mlx16 C Compiler and associated tools	Mlx16_GCC_setup_x_xx_x.exe
MLX81200 SW Platform	Includes general chip operation especially the LIN feature	Available on Softdist
Melexis USB LIN Master Software	PC software for LIN Master	Comes with MLX USB LIN Master on CD
MLX81200 BLDC Firmware	BLDC Firmware for the Demo kit setup	BLDC_DemoKit_Firmware_x.zip
MLX81200 PC program	PC program to control the BLDC firmware via LIN	MLX81200_Demokit_PCProgram_x.exe
MLX81200 SCT	PC program to configure, build und flash the BLDC-Demokit firmware	MLX81200_SCT_x.exe
MLX81200 Software Source code	BLDC Firmware sources for the BLDC Demokit	BLDC_x_Demokit.zip

Tbl. 2 Contents Software

3. How to use the MLX81200 SW Development kit

The following table introduces the philosophy of the MLX SW Development kit and gives an overview about the different options for development with the kit.

Task	Hardware	81200 specific hardware	Required software
Software development in Assembler			- Editor - Mlx16 Melexis Assembler
Software development in C			- Editor - Mlx16 GCC C Compiler
Software Simulation in Assembler	- PC		- Mlx16 Simulator
Software Simulation in C	- PC		- Mlx16 C Debugger
In-Circuit Emulation in Assembler	- PC - Mini E-MLX Emulator	- Evaluation board	- Mlx16 Simulator - Mlx16 Emulator - 81200x.mmf configuration file
In-Circuit Emulation in C	- PC - Mini E-MLX Emulator	- Evaluation board	- Mlx16 Simulator - Mlx16 Emulator - 81200x.mmf configuration file
Quick HW Test	- PC - Mini E-MLX Emulator	- Evaluation board	- Mlx16 Simulator - Mlx16 Emulator - 81200x.mmf configuration file - Demo Software for the Evaluation board
Configure, build and program via pin LIN	-PC -Mini E-Mlx Emulator or -USB-LinMaster 2.0	-Evaluation board -MLX81200 IC with loader support	-Mlx16 GCC Compiler -MLX81200 SCT

Tbl. 3 How to use the SW Development kit

4. The Software Kit

4.1. Software Evaluation flow

The documentation for the development tools listed above is included with those tools and is outside the scope of this document. Despite that, a brief flow of the software development for the MLX81200 is given below in Fig. 1. Software can generally be written in Assembler or in C.

4.1.1. Software Development in Assembler language

Assembler source file(s) can be written with all common non-formatting editors. The code is then compiled with a Melexis supplied assembler, which is customized for the Mlx16X8 instruction set and supports all standard features of other commercial compilers.

The linker will merge the object files generated by the assembler and create a final file (*.hex, *.cod). This final *.hex file can be used in two different ways:

- for simulation purposes with the Mlx16 Simulator
- for in-circuit debugging/testing (programmed to Flash)

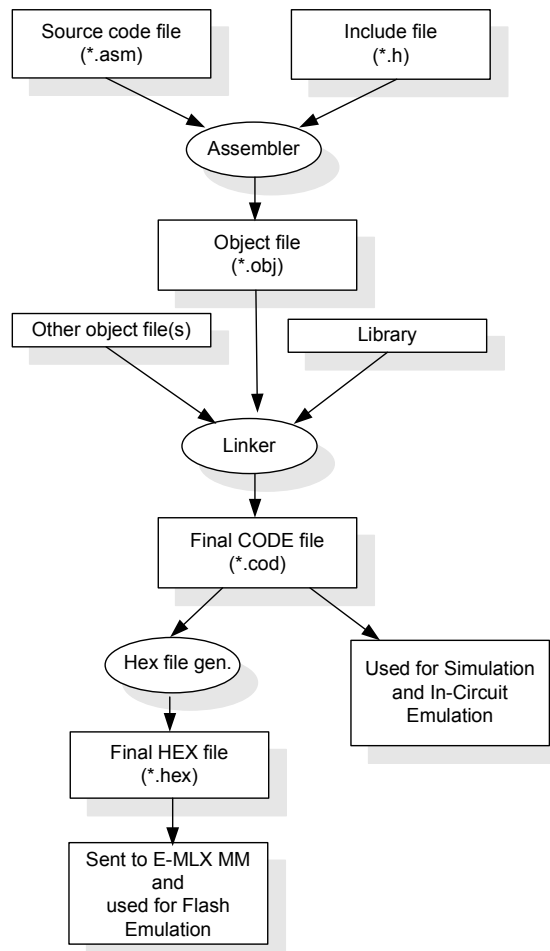

Fig. 1 Flow of the Software Development using Assembler and Melexis tools

4.1.2. Software Development in C language

Gnu has also developed a C compiler, Assembler and Linker. This tool chain supports all known features of other common compilers. The creation of C source file(s) can be achieved with any common non-formatting editor. The code is then compiled and linked with the above mentioned Gnu tools (see Tbl. 2) With this methodology:

- All C language based features can be used
- Assembler parts (previously compiled to object file level) can be included
- ROM and In-circuit emulation is possible on C instruction level

NOTE: The object files of Gnu and Melexis supplied Assembler are not compatible. Therefore the Gnu provided Assembler must be used, in case Assembler sources should be included with a Gnu C source.

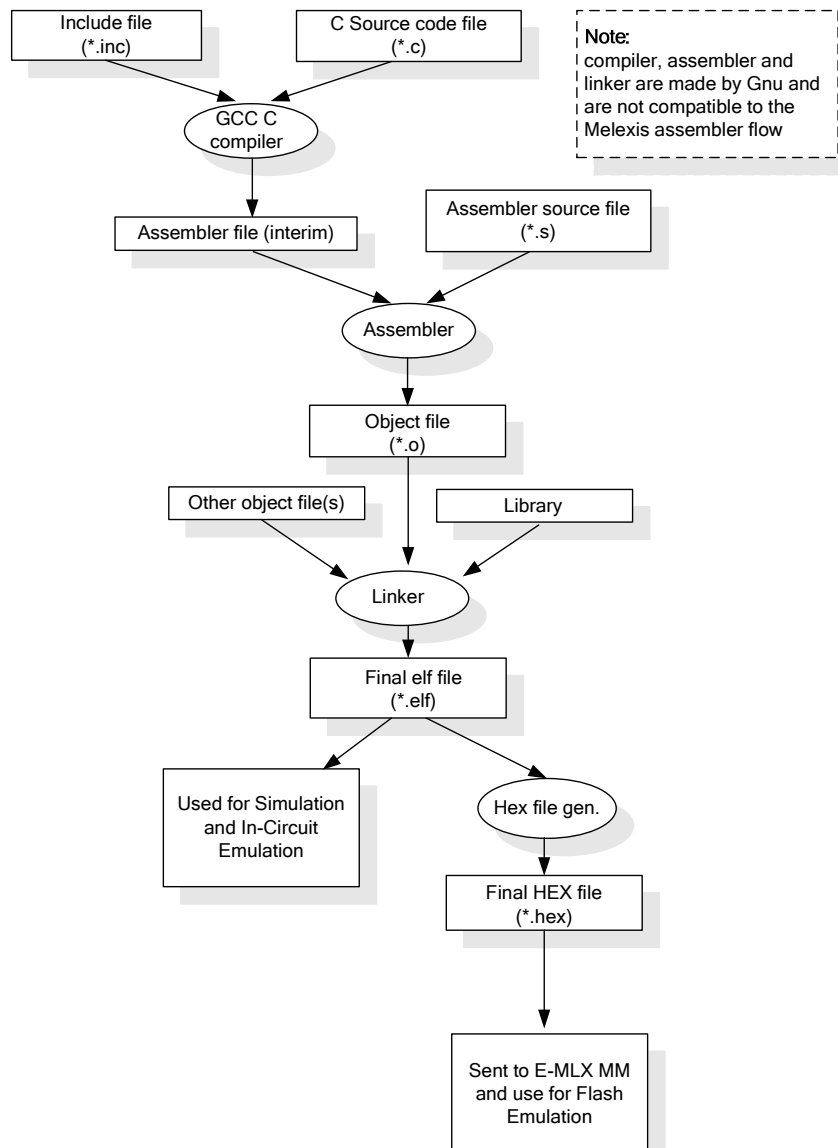

Fig. 2 Flow of the Software Development using the Gnu C Compiler tools

4.2. The installation of the Software Kit

4.2.1. Installation of the tools

All tools run under WinXP®. Win9x, WinNT® and Win2000® are not supported. All programs use the standard windows installer of WinXP®.

The following tools have to be installed:

- | | |
|------------------------------------|--|
| • EmlxSetup_x_x_x.msi | Emulator Software and hardware driver |
| • Mlx16Setup_x_xx_x.exe | Mlx16 Simulator Software |
| • MDC_Setup_x_x_x.exe | Mlx16 Interactive Debugger |
| • EMlxMMPProgSetup_x_x_xx.msi | Flash Programmer Software |
| • Mlx81200Conf_x_x_x.msi | Configuration file, consists of chip specific settings |
| • Mlx16_GCC_setup_x_xx_x.exe | Mlx16 C Compiler |
| • MLXLinMaster_Setup.exe | USB LIN Master Software |
| • MlxLinDebug.exe | Melexis USB LIN Master |
| • MLX81200_Demokit_PCProgram_x.exe | PC program to control the BLDC firmware via LIN |
| • MLX81200_SCT_x.exe | PC program to configure, build und flash the BLDC-Demokit firmware |

x – Revision number

Demo Software can be copied at any top level directory:

- | | |
|---------------------------------------|---|
| • Software_Platform_MelexCM_x_x_x.zip | Software platform including the Demo Software |
| • BLDC_DemoKit_Firmware_x_x.zip | firmware for the Evaluation setup |
| • BLDC_x_Demokit.zip | the source code of the BLDC DemoKit firmware |

4.2.2. Directory structure of the Software Tools

It is recommended to use the “standard” installation option. After installing with this installation option, the following path settings and directory structure appears:

C:\Programs\Melexis\	
E-Mlx MMProgrammer	FLASH Programmer Software
Bin	MLX Assembler Package
Bin\Doc	MLX Assembler Development System Documentation
Emulator	Emulator Software and help file
Simulator	MLX16 Simulator/Emulator (Assembler)
MDC	MLX16 Interactive C Debugger and manual
MLX81200_DemoKit_PCprogram	MLX81200 Control Software

The release of Mx16 GCC suite installs in the following directory tree:

C:\mlx16-gcc\ bin	contains executable files.
Lib	contains libgcc library and include files and compiler specs.
mlx16	contains libmlx16 library and include files; start-up module; linker command files and memory map.
libexec	additional executable files.
config	configuration file and script for Mlx16 Simulator.
docs	documentation.
examples	sample programs.
C:\Programs\Common Files\Melexis Shared\Config\81200 81200.mmf	Configuration file for Simulator, Emulator and Flash Programmer
C:\Programme\LIN Commander\LinCommander.exe LinCommander.exe	a sample interface program that can be used to debug via the LIN bus when developing an application.

4.2.3. Directory structure of the Demo Software

The setup works with relative paths, so it can be copied into any top level directory.

NOTE: Please make sure that directory path does not contain any spaces

It contains the following folders:

\bin	Utilities
\config	Makefile configurations
\doc	Documentation related to general MelexCM platform software
\include	Common libraries include directory
\lib	Common libraries (.a), library object files and linker files
\mmf	Test controller files and tools
\libsrc	Root of the common libraries sources
\libsrc\lib	Source code of the common libraries
\libsrc\LIN	LIN library source code
\libsrc\math	Math library source code
\projects	Root of the projects sources
\projects\Examples	Projects which are independent from analogue chip periphery
\projects\81200	Root of the MLX81200 project
\projects\81200\include	The MLX81200 specific declarations (analogue port names etc.)
\projects\81200\src	The MLX81200 common versions of the product specific functions (analog_trimming, power_down and vectors.S) and projects
\projects\LINLoader	LIN pin loader source code (LIN mode or standalone)

Tbl. 4 Folder description

5. Hardware Kit

5.1. Configuration

- Evaluation board in conjunction with the Mini E-MLX Emulator
- Used for In-Circuit debugging
- Flash programming possible
- LIN Communication possible

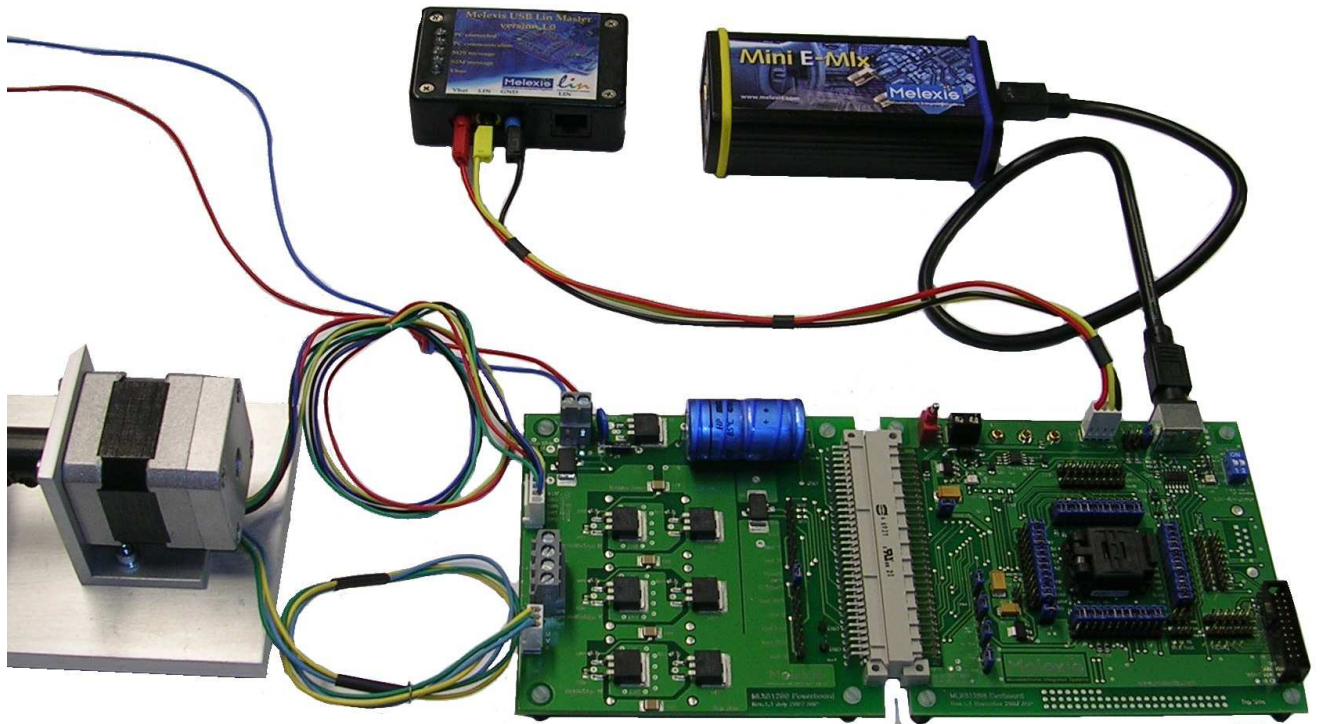

Fig. 3 Arrangement of Evaluation board in conjunction with Power board, Mini E-MLX Emulator , BLDC motor and Melexis USB LIN Master

5.2. General

The purpose of the HW kit is the development of software for the MLX81200 BLDC Motor Controller. Using this HW kit, the device can be evaluated in a detailed fashion.

The evaluation system is composed of an evaluation board and the power board. The idea of the evaluation system is to have two stand-alone boards:

- A standard board (evaluation board) is used for all possible applications. It consists of a socket for the chip, several pin headers for all signals from the chip and interface connectors to the Emulator, LIN-Bus and the application board (power board).
- A customized application board (power board) has to be designed specifically for a certain application by the user. It is possible to connect this power board on 32-pin connector. The sample power board consists of 3 half Bridges with N-FET-transistors, 2 shunts for possible current supervision and interface connectors to Vbat and the BLDC-Motor.

5.3. Evaluation board

5.3.1. Evaluation board - jumper settings

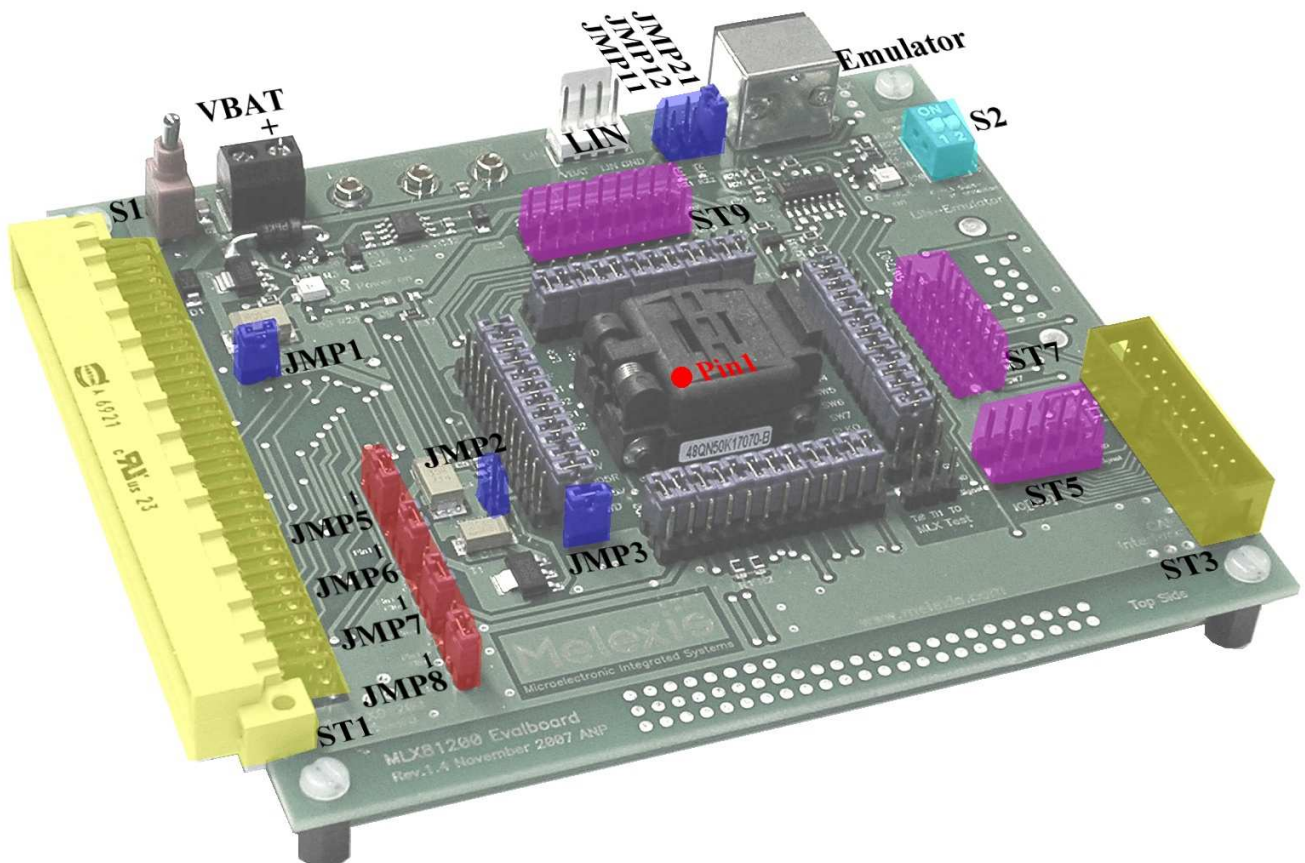

Fig. 4 Location of Connectors on Evaluation board

- JMP1 short : connects Vbat to the chip.
open : disconnects Vbat from the chip
- JMP2 short : connects CWD-pin to GND
open : CWD-pin of the chip is active.
NOTE: the external capacitor for analog Watchdog is active.
- JMP3 short : disables the external regulator NPN transistor for higher VCC loads.
open : enables the external regulator NPN transistor for higher VCC loads
- JMP5 1-2 : enable low pass filter R55/C15 and voltage divider R5/R50 for pin T
2-3 : enable only the voltage divider R5/R50 for pin T
- JMP6 1-2 : enable low pass filter R66/C16 and voltage divider R6/R60 for pin SW5
2-3 : enable only the voltage divider R6/R60 for pin SW5
- JMP7 1-2 : enable low pass filter R77/C17 and voltage divider R7/R70 for pin SW6
2-3 : enable only the voltage divider R7/R70 for pin SW6
- JMP8 1-2 : enable low pass filter R88/C18 and voltage divider R8/R80 for pin SW7
2-3 : enable only the voltage divider R8/R80 for pin SW7
- S2 consists of the jumper JMP9 and JMP10:
- JMP9 short : the connection between the chip and the emulator is split
open : the connection between the chip and the emulator is established, the chip can be accessed by the emulator, if the emulator is not plugged the CPU is executing the flash program
- JMP10 short : CPU does not execute the flash program
open : CPU is executing the flash program, if no emulator is connected and JMP9 is shorted
- JMP11 short : the pull up resistors R21 and R22 are connected to the test interface inputs
+JMP12 (necessary if the E-mlx MM programmer is used)
open : the pull up resistors are disconnected (default for the Mini E-Mlx programmer)
- JMP21 short : supply the additional voltage regulators inside the Mini E-Mlx programmer (required)
open : disconnect VBAT from the test interface (required for the E-mlx MM programmer)
NOTE: If the E-Mlx MM programmer is connected and the JMP21 is shorted the diode D4 can be destroyed.

5.3.2. Functionality of the Evaluation Board

Main Power Switch S1 selects between supply connector of the evaluation board or the supply connector of the power board.

IMPORTANT: If the evaluation board is supplied via the power board, the power supply connector of the Evaluation board should **NOT** be connected! Otherwise the board or the power supply will be damaged!

The PCB only requires a DC voltage of +12...+18V which is applied via the supply connector of the evaluation board. This is valid if the evaluation board is used stand-alone without the power board. In case the board is used alongside the power board, the power board delivers the supply voltage for both PCBs.

Both the evaluation board and the power board are protected against reverse polarity.

5.3.3. Evaluation board – Phase signal filters

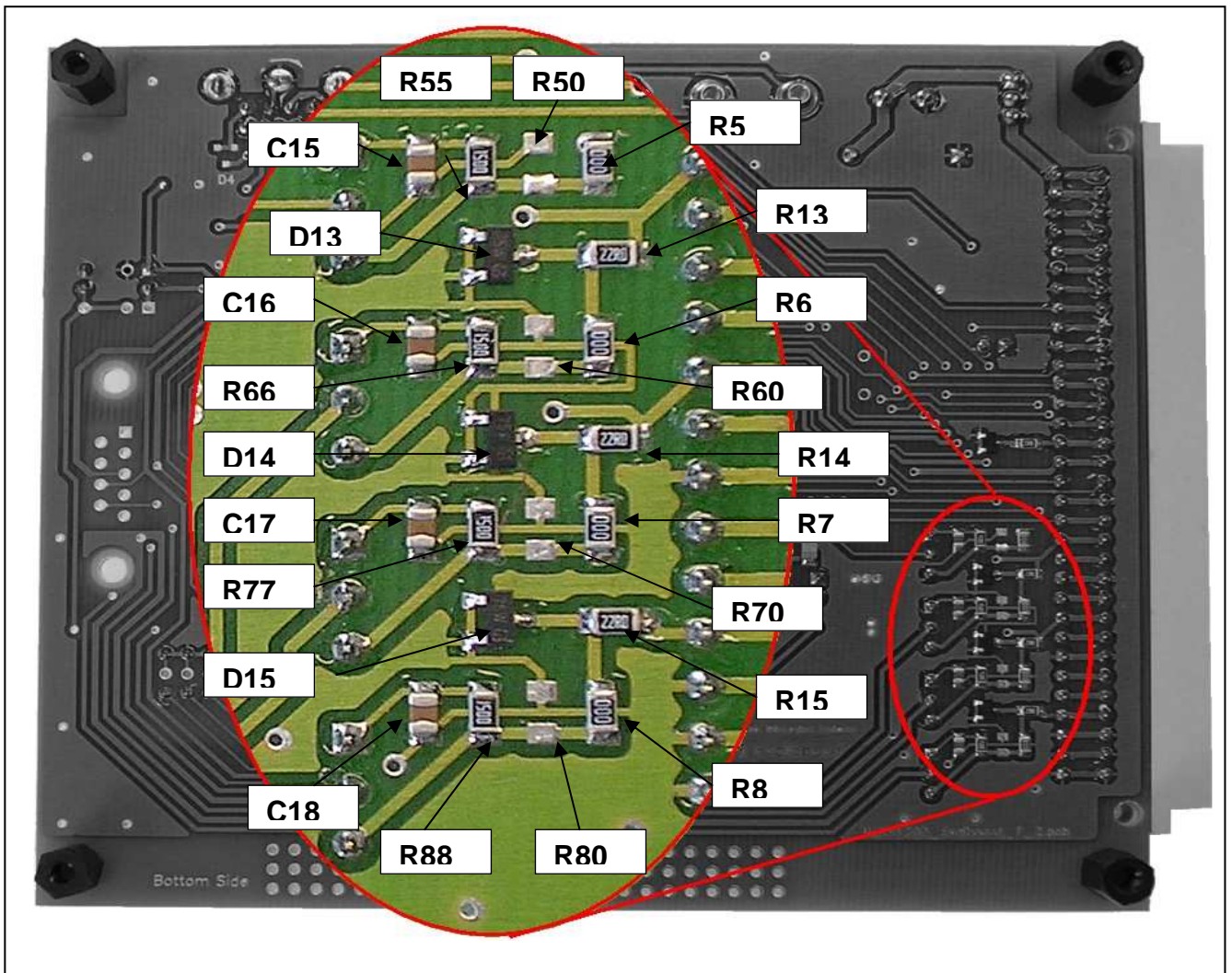

Fig. 5 Position of the filter components on the EVB

The resistors R13, R14, R15 and the diodes D13, D14, D15 protect the IC against negative current and voltage from the motor coils. The resistors increase the discharging time of the high side n-channel MOSFET transistor gates.

The phase signals on the T, SW5, SW6 and SW7 pins can be reduced with the voltage dividers R5/R50, R6/R60, R7/R70 and R8/R80.

With the low pass filters R55/C15, R66/C16, R77/C17 and R88/C18 fast disturbances can be filtered out. The default value for the resistor is 150 ohm and for the capacitor is 10nF.

5.3.4. Evaluation board - Jumper ring

The jumper ring enables the user to either connect or disconnect all signal lines to the chip. By removing jumpers, the circuit from the chip to the application hardware can be disconnected e.g. for measuring current or applying external signals. All jumpers are described with the specific pin names on the board.

5.3.5. Connection between Power Board Port and Evaluation Board

Pin	Name	Description	Direction
1	GND	Ground	
2	GND	Ground	
3	GND	Ground	
4	W	IC-Pin 24	Input
5	HS2	IC-Pin 25	Output
6	SW0	IC-Pin 23	Input/Output
7	GND	Ground	
8	SW1	IC-Pin 22	Input/Output
9	V	IC-Pin 31	Input
10	HS1	IC-Pin 30	Output
11	GND	Ground	
12	SW2	IC-Pin 21	Input/Output
13	U	IC-Pin 33	Input
14	HS0	IC-Pin 34	Output
15	GND	Ground	
16A	VBAT_S2	IC-Pin 40	Input
16C	VBAT_S1	IC-Pin 39	Input
17	V5EXT	IC-Pin 2	Output
18	T	IC-Pin 37	Input
19	GND	Ground	
20	LS2	IC-Pin 27	Output
21	LS1	IC-Pin 28	Output
22	LS0	IC-Pin 36	Output
23	GND	Ground	
24	EN_VS	Bootstrap output from IC-Pin 15 -CLKO	Output
25	SW3	IC-Pin 20	Input/Output
26	GND	Ground	
27	GND	Ground	
28	GND_S2	IC-Pin 42	Input
29	GND_S1	IC-Pin 41	Input
30	GND	Ground	
31	VBAT	unprotected voltage from Power board	Input
32	VBAT	unprotected voltage from Power board	Input

Tbl. 5 Connector ST1(male) on Evaluation board

5.3.6. Evaluation board – extension port ST3

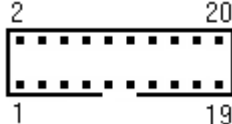
Connector ST3 on Evaluation board			
Pin	Name	Description	
1	V5V or V5EXT	5V power supply or protected switchable V5ext	
2	VS	Protected voltage	
3	SW3	STB	
4	SW4	Wake-up interrupt signal (INH)	
5	GND	Ground	
6	IO5	Interrupt from CAN module	
7	GND	Ground	
8	IO4	SPI clock	
9	GND	Ground	
10	IO3	SPI MOSI	
11	GND	Ground	
12	IO2	SPI MISO	
13	GND	Ground	
14	IO1	SPI chip select	
15	GND	Ground	
16	Not used		
17	Not used		
18	Not used		
19	Not used		
20	Not used		

Tbl. 6 Connector ST3 on Evaluation board (for example a CAN extension board can be connected)

5.3.7. Evaluation board - Signal pin headers

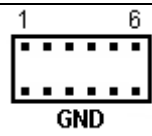
Connector ST5 on Evaluation board			
Pin	Name	Description	
1	IO0	IC Pin 1	
2	IO1	IC Pin 7	
3	IO2	IC Pin 10	
4	IO3	IC Pin 12	
5	IO4	IC Pin 9	
6	IO5	IC Pin 3	

Tbl. 7 Connector ST5 on Evaluation board

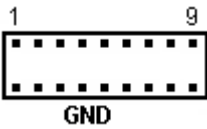
Connector ST7 on Evaluation board		
Pin	Name	Description
1	LS0	IC Pin 36
2	CP0	IC Pin 25
3	HS0	IC Pin 34
4	HS1	IC Pin 30
5	CP1	IC Pin 29
6	LS1	IC Pin 28
7	LS2	IC Pin 27
8	CP2	IC Pin 26
9	HS2	IC Pin 25

Tbl. 8 Connector ST7 on Evaluation board

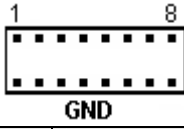
Connector ST9 on Evaluation board		
Pin	Name	Description
1	SW0	IC Pin 23
2	SW1	IC Pin 22
3	SW2	IC Pin 21
4	SW3	IC Pin 20
5	SW4	IC Pin 19
6	SW5	IC Pin 18
7	SW6	IC Pin 17
8	SW7	IC Pin 16

Tbl. 9 Connector ST9 on Evaluation board

5.3.8. Evaluation board - Reset

Resets are always active low and can be achieved by the following options:

- Turning off the power switch on the Evaluation board resets all components of the Evaluation board as soon as the charge of the block capacitors falls below the reset threshold level

In case of working with the Mini E-Mlx Emulator, there are two more reset options (this is valid only for the digital part of the chip, MelexCM):

- Sending a new software (*.x16 or *.elf file) to the Emulator will reset the MelexCM chip automatically
- Reset can also be achieved by the 'Reset' button of the PC Simulator/Debugger software.

IMPORTANT: Reset of the whole chip including the analog part can ONLY be achieved by turning off the power switch.

6. Quick start up

6.1. Using the C flow

Assembling/Linking:

- change to the .libsrc directory
- open a command prompt and type:
`'gmake clean'`
`'gmake install'`
- change to the directory where the source code is situated, e.g. .\projects\81200\BLDC\
• open a command prompt and type:
`'gmake clean'`
`'gmake all'`

-> executable *.elf file is created in the same directory
-> executable *.hex file is created in the same directory

Simulation:

- Start the MLX Interactive Debugger '`...\Melexis\MDC\MLXDBGW.exe`'
- Select target 'Mlx81200' and 'Simulator' from 'Tools' -> 'Target & Engine' menus as shown in Fig. 6
- Load the appropriate *.elf file – 'File' -> 'Open'
- Run the *.elf files by pressing the 'Go' or 'Step' icon

Emulation:

- Connect the Mini EMlx Emulator to the PC via an USB cable
- Insert a MLX81200 chip to the appropriate socket on the Evaluation board
- Power up the Evaluation board and connect the Mini EMlx Emulator to the EVB
- Start the MLX Interactive Debugger '`...\Melexis\MDC\MLXDBGW.exe`'
- Select target 'Mlx81200' and 'Mini EMlx' from 'Tools' 'Target&Engine' menus as shown in Fig. 6
- Load the appropriate *.elf file – 'File' -> 'Open'
- Run the *.elf files by pressing the 'Go' or 'Step' icon

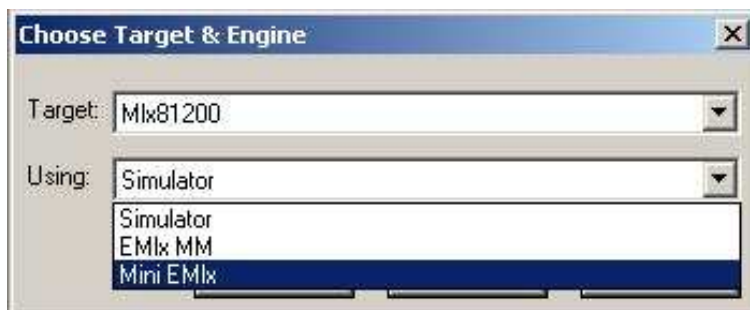

Fig. 6 Interactive Debugger: Selecting Simulator or Emulator mode

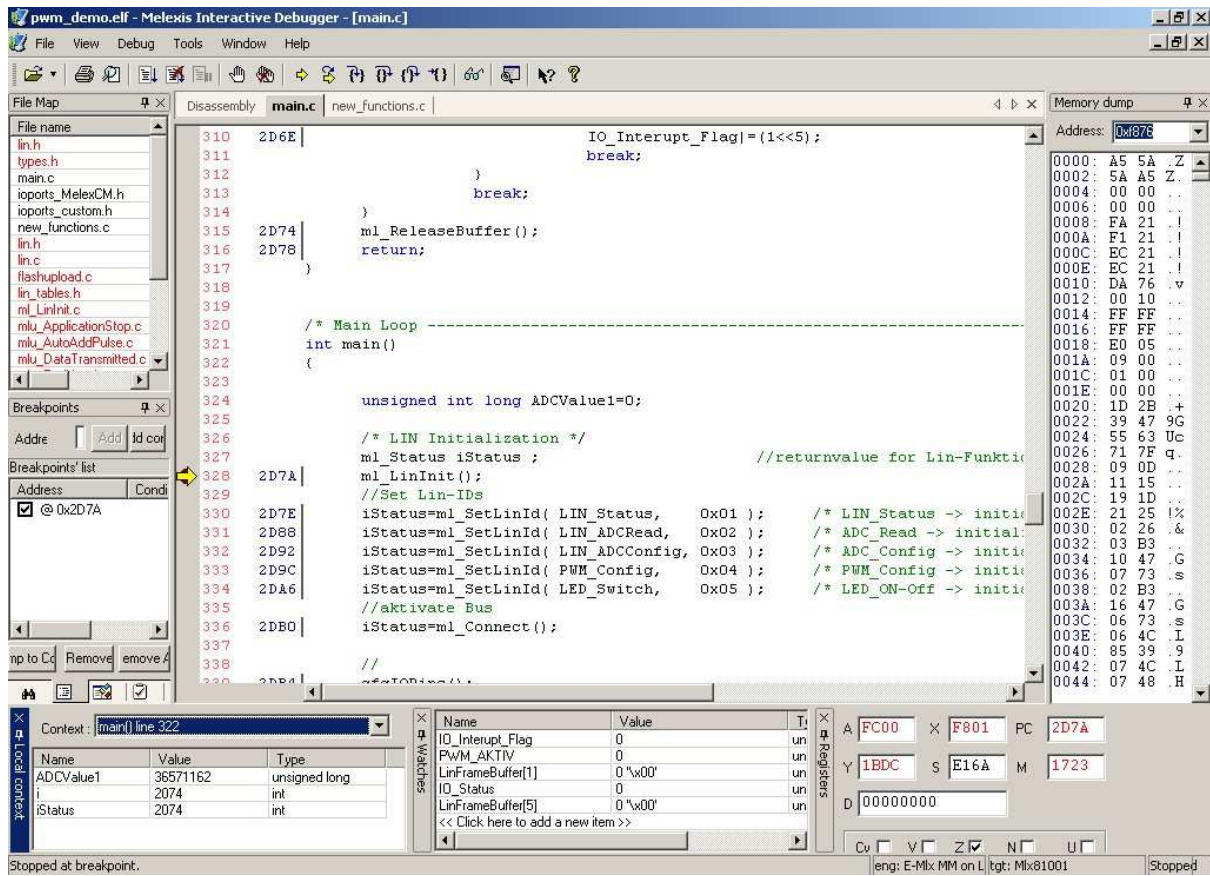

Fig. 7 Melexis Interactive Debugger session

6.2. Programming a HEX file to the FLASH

- Connect the Mini E-MLX Emulator to the PC via an USB cable
- Insert a MLX81200 chip into the socket and power up the EVB
- Connect the Mini E-MLX Emulator (programmer) to the EVB
- Start the programmer software ‘...\Programmer\EMlxMMProg.exe’
- Select File\Open... to open the Mlx81200 mmf file installed by Mlx81200Conf_x_x_x.msi

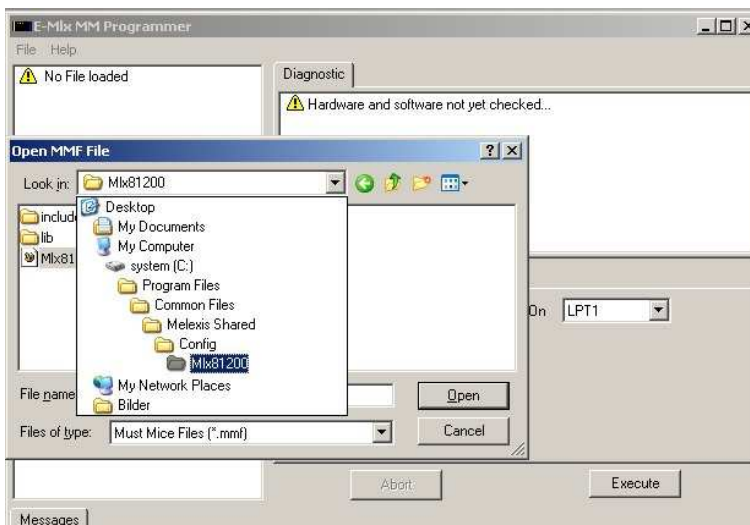

Fig. 8 E-Mlx MM Programmer: Path to the Mlx81200.mmf file

- Select ‘Tools\Options\Programming’ tick checkbox ‘Keep Supply between patterns’

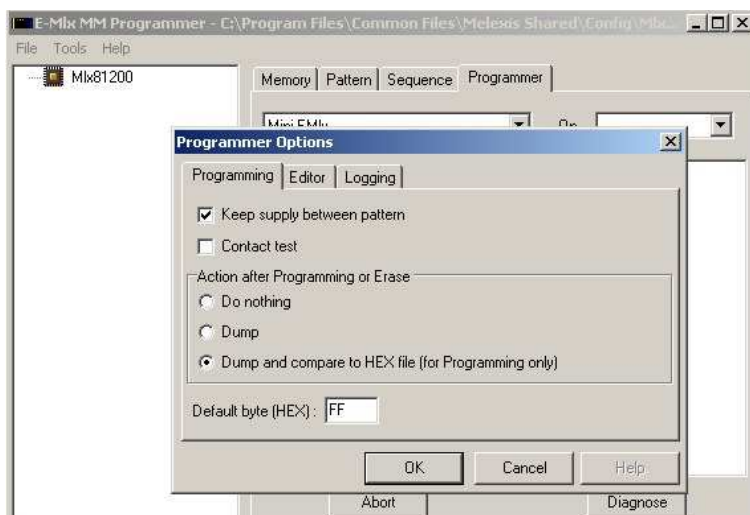

Fig. 9 E-Mlx MM Programmer: Option “keep supply between pattern”

- Select tab 'Programmer', choose from pull-down menu 'Mini E-mlx' on 'Autodetect'

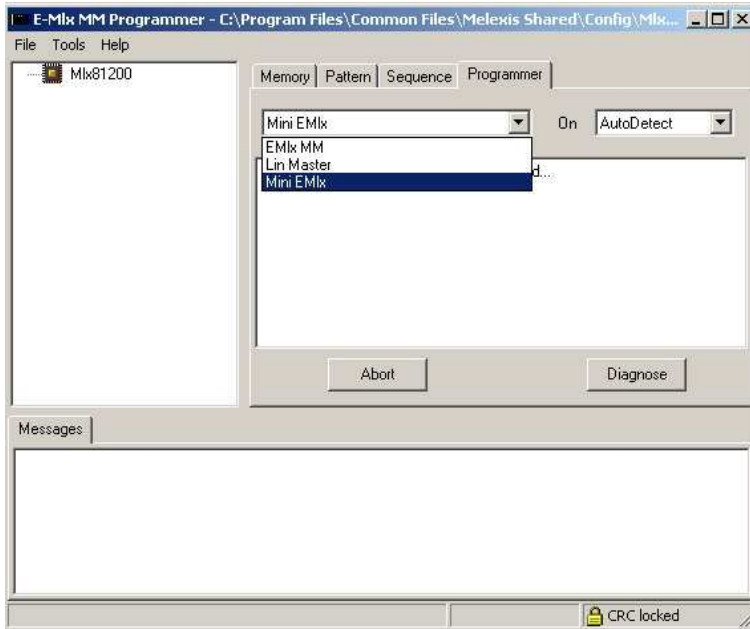

Fig. 10 E-Mlx MM Programmer: Chose the Mini E-mlx

- Push the 'Diagnose' button
 -> This message should appear : >>> Info : Hardware successfully checked!

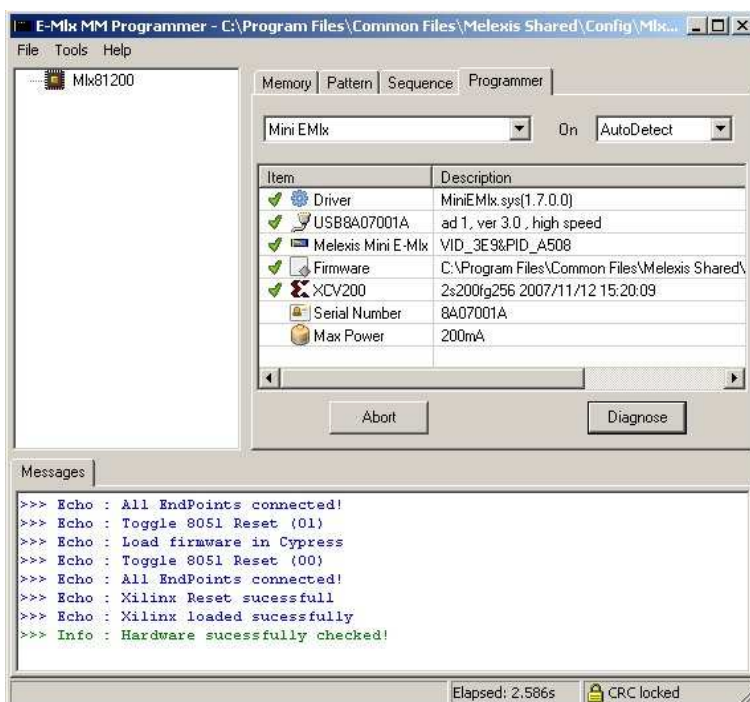

Fig. 11 E-Mlx MM Programmer: checking connected emulator

- Select tab 'Pattern' and go to pattern 'POWER_ON'
- Push the 'Execute' button -> in addition to D3 "Power on" D20 "E-MLX on" should light up

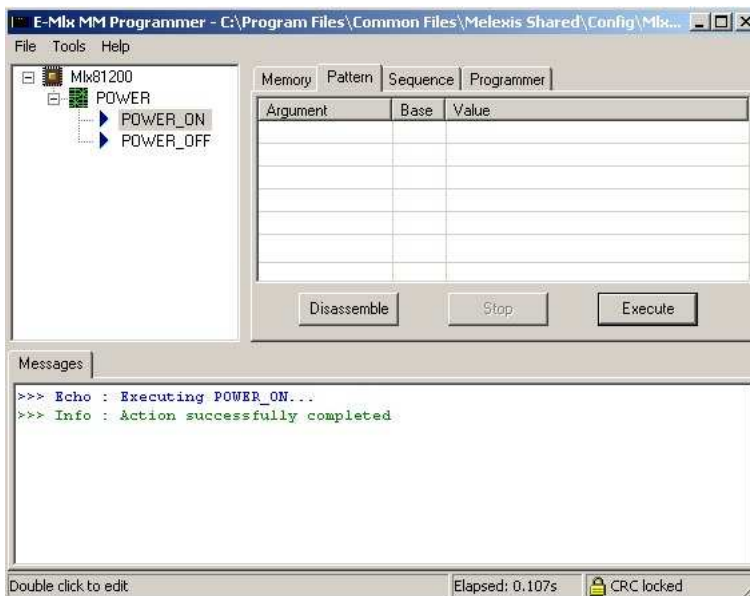

Fig. 12 E-Mlx MM Programmer: enable programmer interface

- Select 'Flash' from the tab 'Memories' sections
- Select the 'Program using HEX file' radio button
- Load a *.hex file and push the 'Execute' button
- Verify the programmed file by pushing the 'Compare Dump to HEX file' radio button and press 'Execute' again

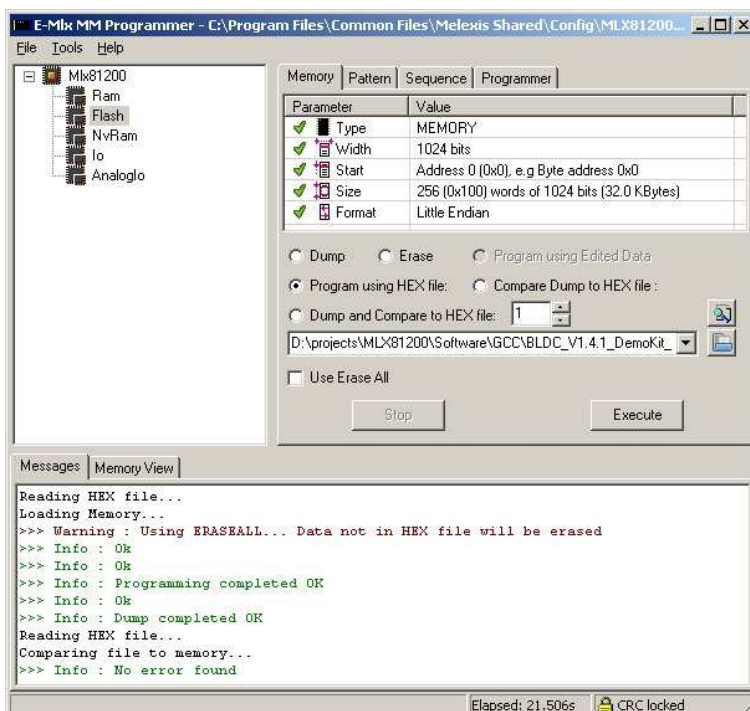

Fig. 13 E-Mlx MM Programmer: programming the flash

- Before disconnecting the Mini EMLX select tab 'Pattern' -> 'POWER_OFF'
- Push the 'Execute' button
- D20 "E-MLX on" should now be turned of

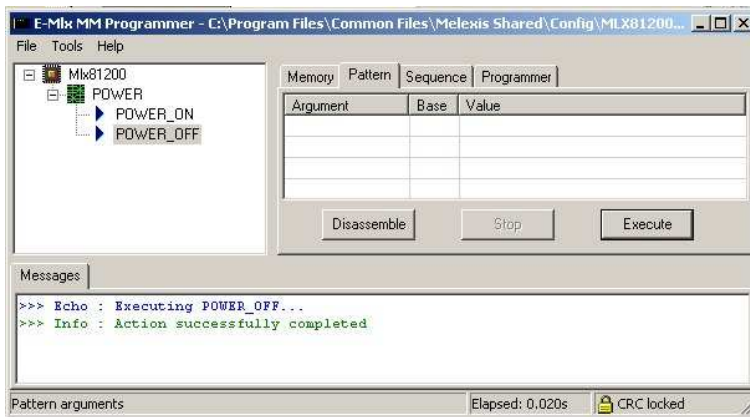

Fig. 14 E-Mix MM Programmer: disable programmer interface

- The evaluation board can now be switched off
- Mini E-MLX Emulator can now be safely removed

For generating *.hex code please refer to 6.1

7. MLX81200 Software configuration tool (SCT)

7.1. General

The Software configuration tool can be used to configure, compile and flash the BLDC-Demokit firmware version 2.0.

The Software configuration tool is not suitable to write a complete application. If the file structure is changed or the source files are modified, the tool will not work correctly.

Note: The save function will overwrite the files motorctrl.h, sysdef.h, ramppar.c, .\config\chip.mk and the application Makefile with a defined content. That means any modification will be lost.

The Software configuration tool does NOT include any source code for the MLX81200. The required firmware source files package BLDC_V2.0_DemoKit can be found on the Melexis Softdist server. The firmware needs to be unpacked to a local folder on the PC. Please make sure that directory path does not contain any spaces.

The SCT is divided into three major parts.

Part 1: locate the demokit firmware sources

Part 2: configure the motor control parameters

Part 3: compile the firmware and flash the firmware into the IC via the pin LIN

A working loader inside the IC is necessary for a successful flash process. Melexis will deliver preprogrammed devices, which include an initial working loader code.

If the preprogrammed loader code was destroyed, the first step must be always the programming of the loader software via test interface. This step can only be executed via the programmer software or debugger using E-mix Emulator.

For programming a HEX file to the flash via the test interface please refer to chapter 6.2

For further information please see:

- the description for the MLX81200 BLDC Demo Kit firmware
- Application Note how to program on module
- Application Note how to flash over pin LIN

7.2. Locate the demokit firmware sources and load the configuration

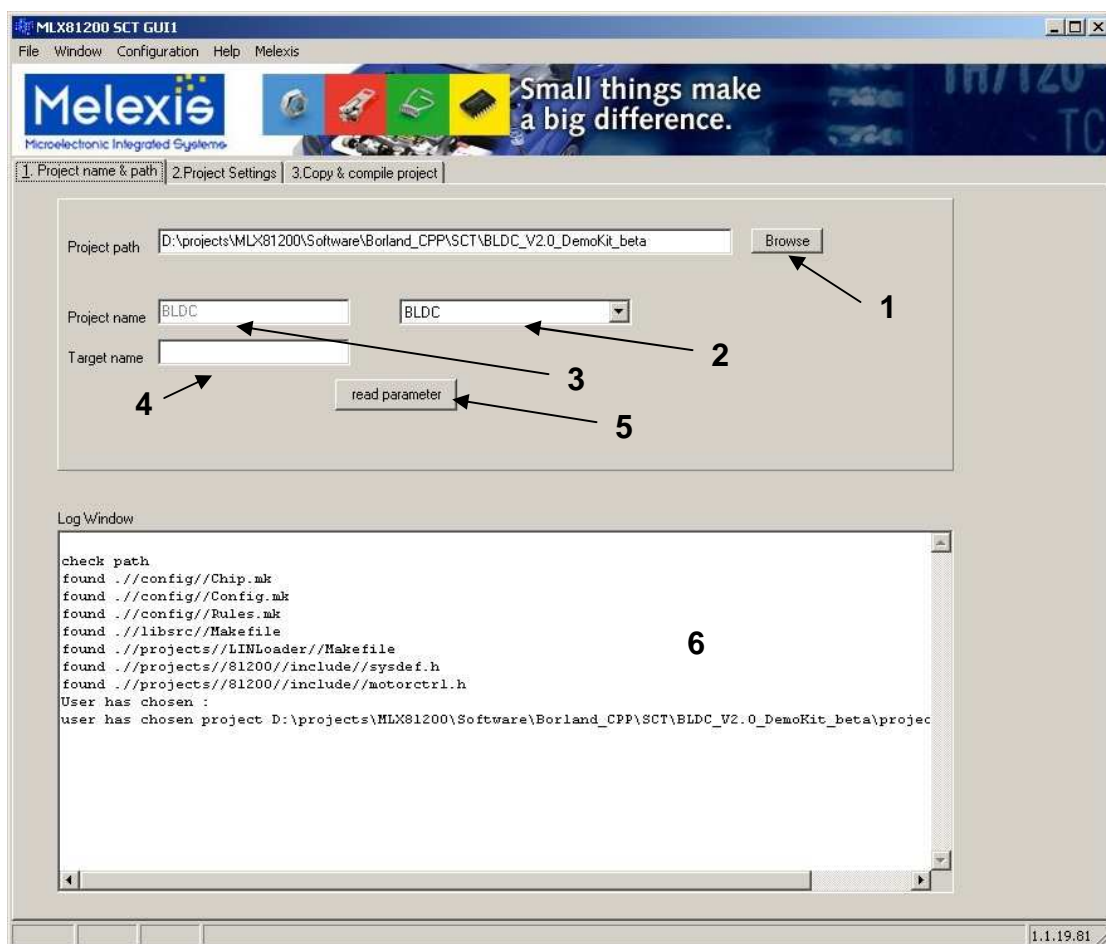

Fig. 15 MLX81200 SCT chose the path and load the configuration

- | | | |
|---|--------------------------|--|
| 1 | Button "Browse" | the path to BLDC firmware source |
| 2 | Project selector | the current project name must be selected |
| 3 | Project name | shows the current project name |
| 4 | Edit field "Target name" | the name of the firmware |
| 5 | Button "read parameter" | the configuration will be read from the chosen directory |
| 6 | Log Window | each operation is shown in this window |

7.3. Configure the demokit firmware

7.3.1. Test pulse configuration

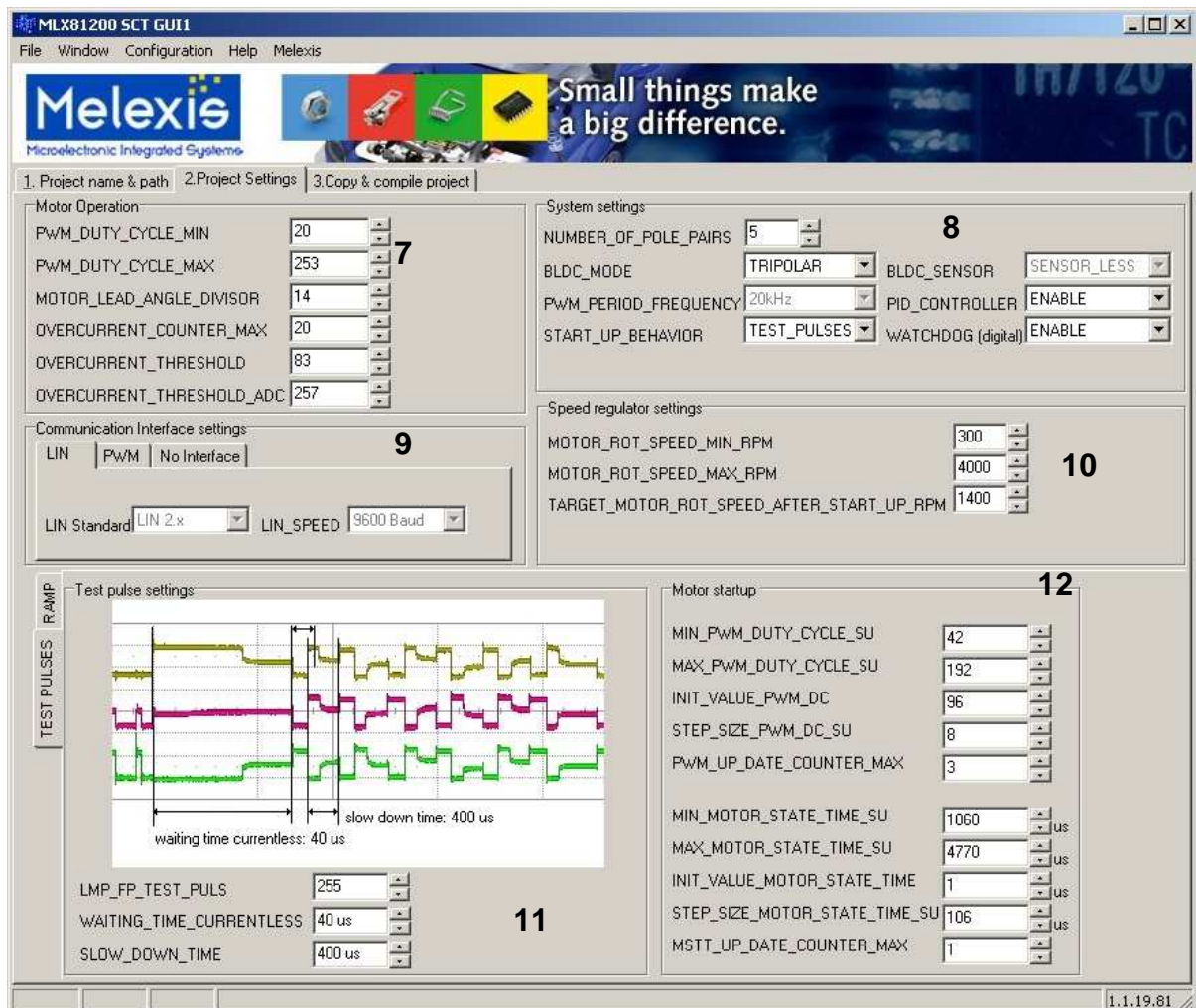

Fig. 16 MLX81200 SCT – modify the parameter of the BLDC-demo kit

- 7 Parameter set "motor operation"
- 8 Parameter set "System setting"
- 9 Parameter set "Communication Interface settings"
- 10 Parameter set "Speed regulator settings"
- 11 Parameter set "Test pulse settings"
- 12 Parameter set "Motor start up test pulses"

7.3.2. Ramp configuration

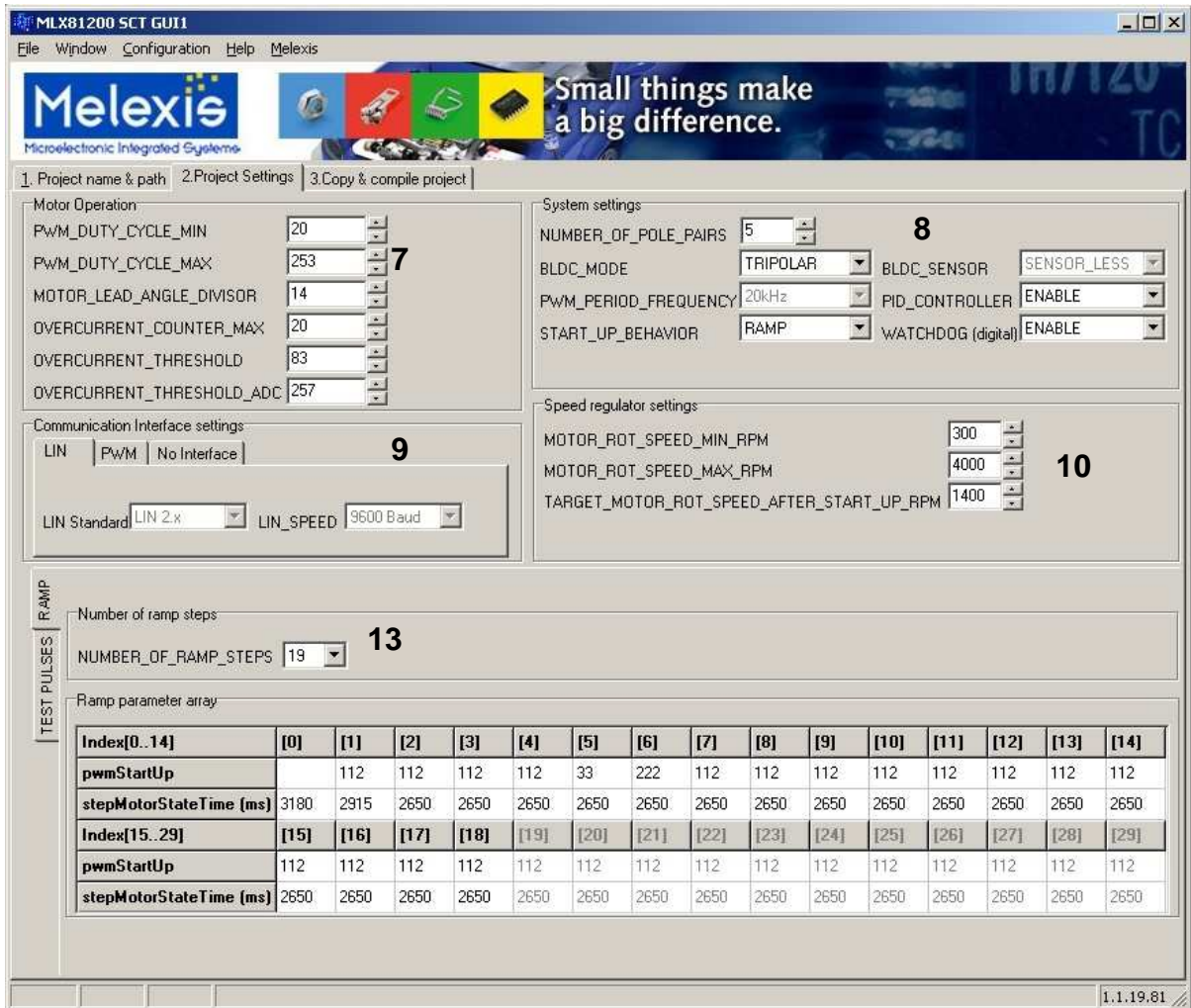

Fig. 17 MLX81200 SCT – modify the parameter of the BLDC-demo kit

- 7 Parameter set “motor operation”
- 8 Parameter set “System setting”
- 9 Parameter set “Communication Interface settings”
- 10 Parameter set “Speed regulator settings”
- 13 Parameter set “Motor start up Ramp”

7.4. Save, compile and program the firmware

7.4.1. Configure the hardware in use

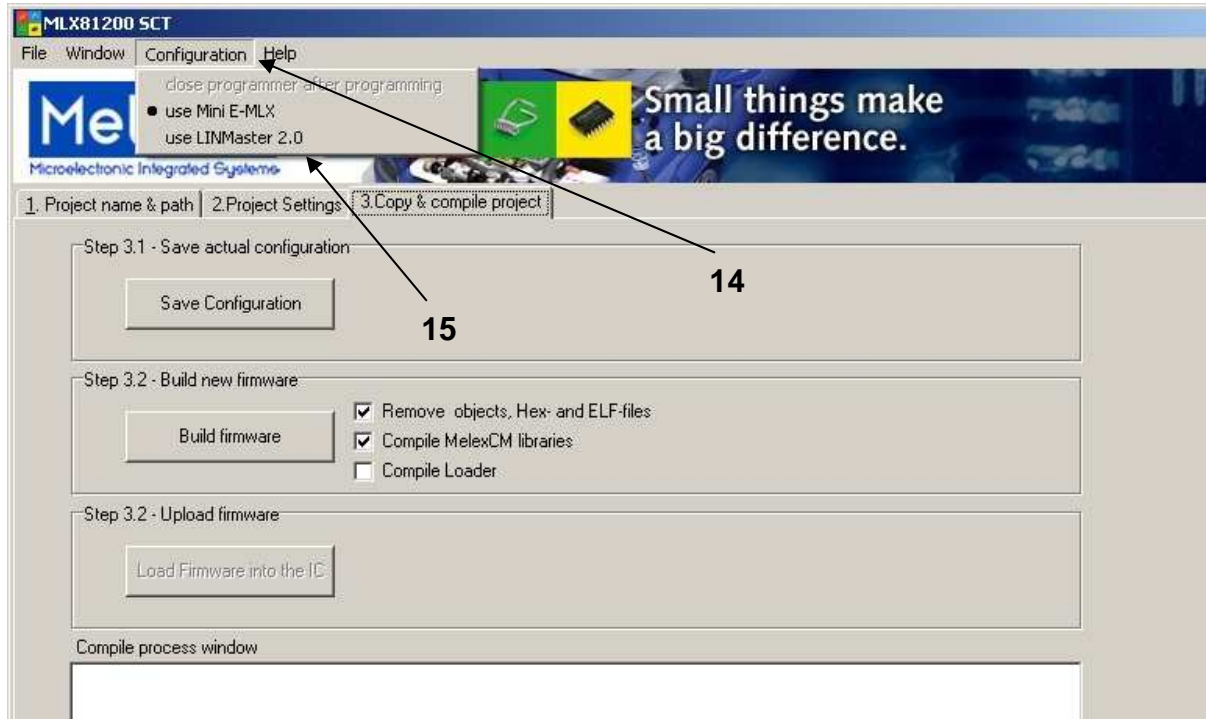

Fig. 18 MX81200 SCT – configure the hardware in use

- 14 Main menu item “Configuration” the SCT can be configured in this menu
 15 Menu item “use Mini E-Mlx” and “use LINMas..” the USB LINMaster or the Mini E-MLX can be chosen

7.4.2. Build process

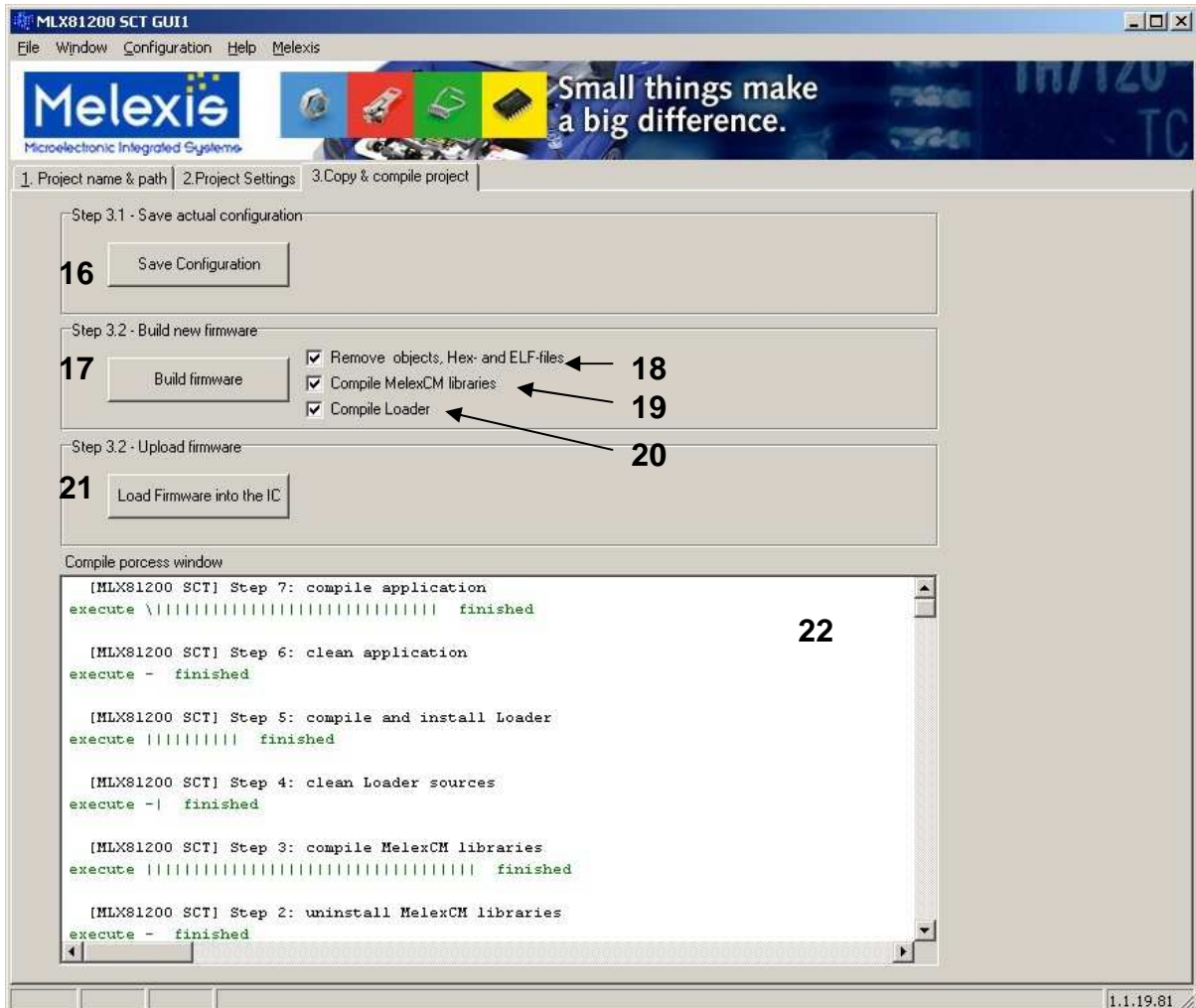

Fig. 19 MX81200 SCT – screenshot running compile process of the BLDC-demo kit firmware

- | | | |
|----|---|--|
| 16 | Button “Save configuration” | the configuration will be saved into the files |
| 17 | Button “Build firmware” | start the compile process |
| 18 | Checkbox “Remove objects, Hex- and Elf-files” | remove the old object and firmware files |
| 19 | Checkbox “Compile MelexCM libraries” | compile the complete MelexCM libraries |
| 20 | Checkbox “Compile Loader” | build the loader firmware from current configuration |
| 21 | Button “Load Firmware into the IC” | start the programmer tool and load the actual firmware into the MLX81200 via pin LIN |
| 22 | Log window “Compile process window” | The compile log messages are shown inside |

7.4.3. Upload the firmware

- Disconnect all other devices from the LIN bus
- Connect the USB-LIN master version 2.0 or the Mini E-Mlx emulator to the pin LIN and to the PC
- Press the Button “Load Firmware into the IC” - The programmer tool is started and will be configured for the used loader protocol
- Do a POR of the MLX81200 when the message “>>> Echo : Entering programming mode...” is shown. Uploading the firmware is only possible immediately after POR and for a certain time (500ms). Afterwards uploading is not possible anymore.
- Wait until the E-Mlx MM Programmer tool has finished with the message “Info : Programming completed OK”
- Close the E-Mlx MM Programmer tool.

A working loader inside the IC is necessary for this process.

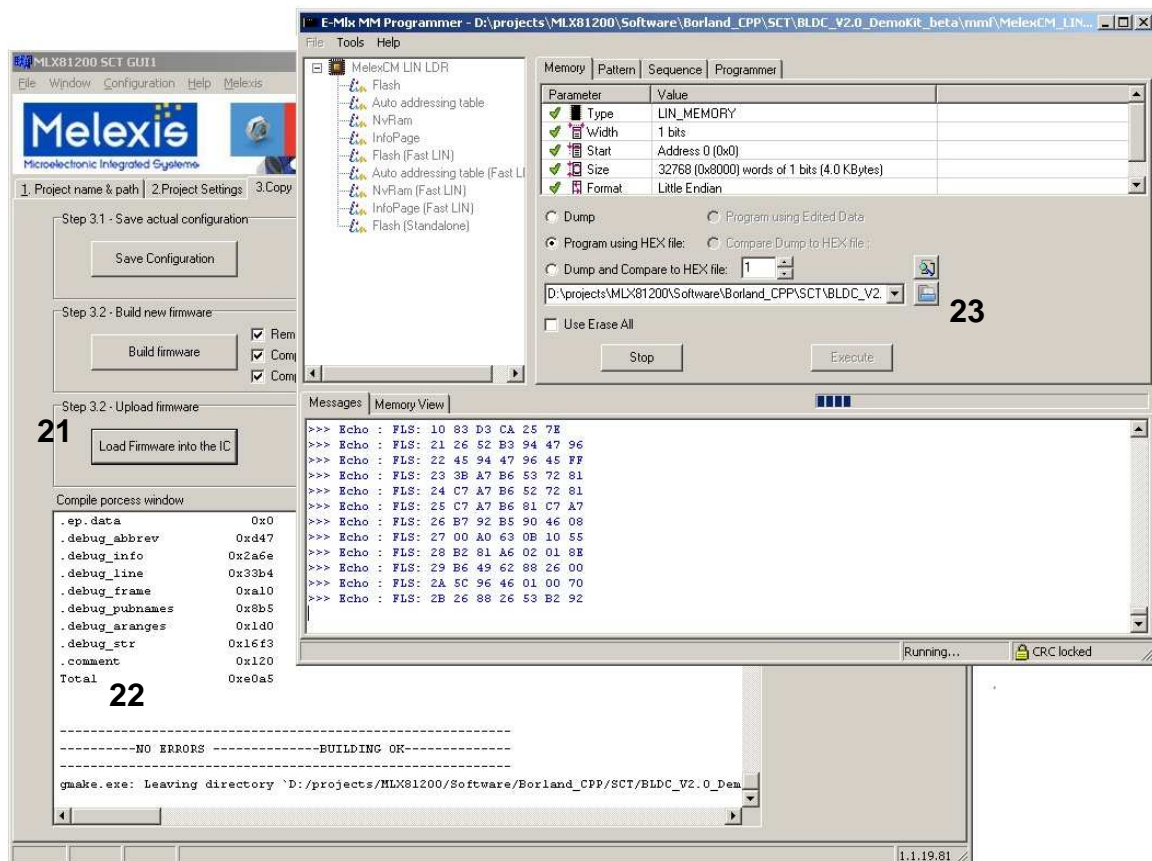

Fig. 20 MLX81200 SCT – uploading procedure with the programmer tool

- | | | |
|----|-------------------------------------|--|
| 21 | Button “Load Firmware into the IC” | Start the programmer tool and load the actual firmware into the MLX81200 via pin LIN |
| 22 | Log window “Compile process window” | The compile log messages are shown inside |
| 23 | E-Mlx MM Programmer tool | The Melexis programmer tool |

8. BLDC DemoKit PC program

8.1. General

The Motor control Software does NOT include any source code for the MLX81200. The required firmware file BLDC_V20_DemoKit_XY.hex MUST be loaded first into the MLX81200. The program MUST be running either by starting the program in the Melexis interactive debugger or let the CPU run free without the emulator out of power on reset.

The BLDC Demokit Firmware can be controlled with the PC program via the LIN bus. The hysteresis brake board can be controlled via the LIN bus too.

For programming a HEX file to the flash please refer to chapter 6.2

8.2. Command line parameter

It is possible to configure the minimum and maximum speed slider values of the graphical interface. The default limits are 500 rpm for the minimum and 5000 rpm for the maximum.

Following parameters are supported:

- -maxspeed:x set the maximum limit
- -minspeed:x set the minimum limit

Example: The command:

```
"MLX81200_Demokit_PC_program.exe -maxspeed:4000 -minspeed:2000"
```

starts the BLDC DemoKit PC program with a speed range from 2000 to 4000 rpm.

8.3. Main window

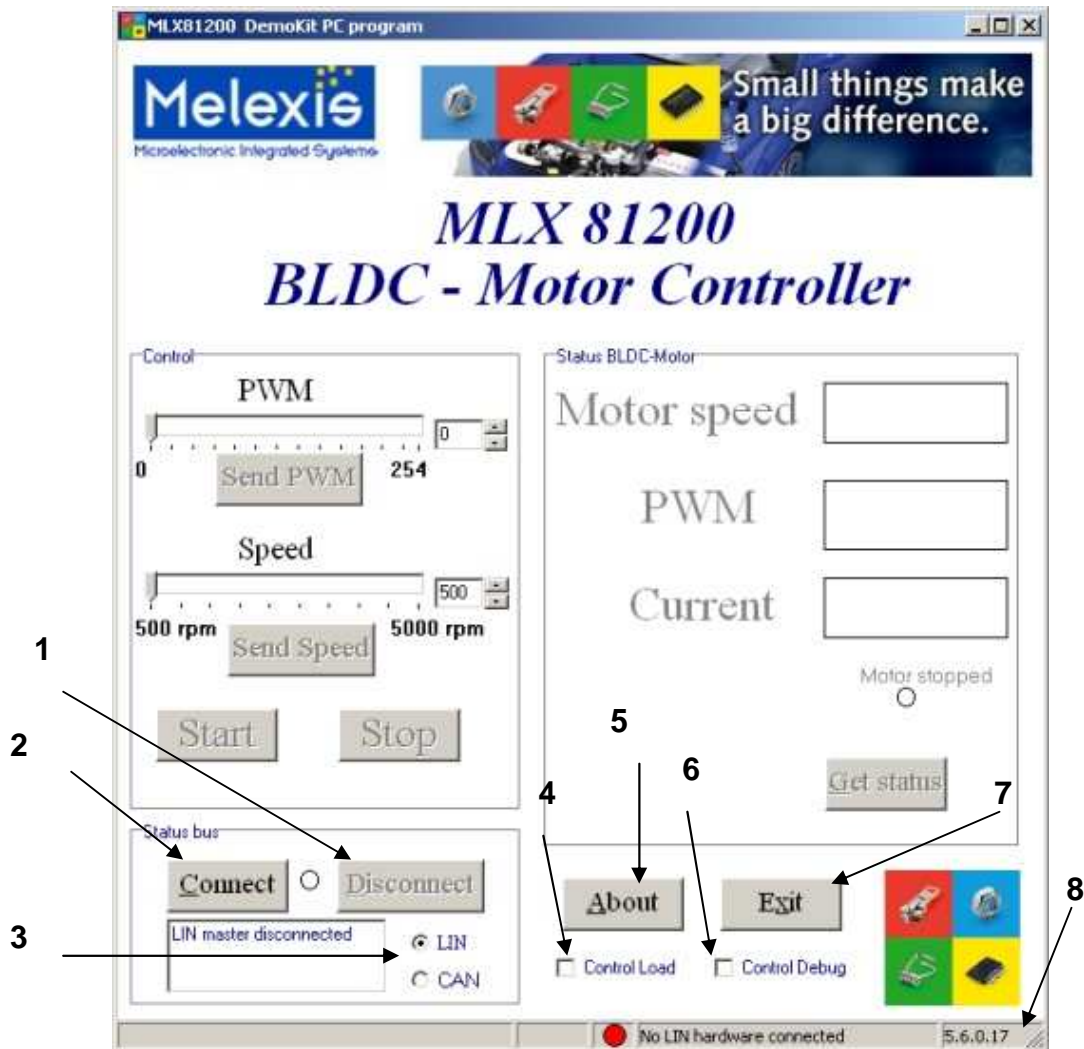

Fig. 21 Main window after start

- | | | |
|---|--------------------------|---|
| 1 | Button "Disconnect" | disconnect the LIN or CAN master. The application does not close. The software can be reactivated by clicking the 'connect' button. |
| 2 | Button "Connect" | connect the LIN master or the CAN master |
| 3 | Interface radio buttons | The interface can be selected with this two radio buttons |
| 4 | Checkbox "Control Load" | open a window to control the hysteresis brake board via the LIN bus |
| 5 | Button "About" | |
| 6 | Checkbox "Control Debug" | open the debug window to control the wave form |
| 7 | Button "Exit" | close all windows and exit the application |
| 8 | Status bar | show the status of the LIN bus and the revision number of the firmware |

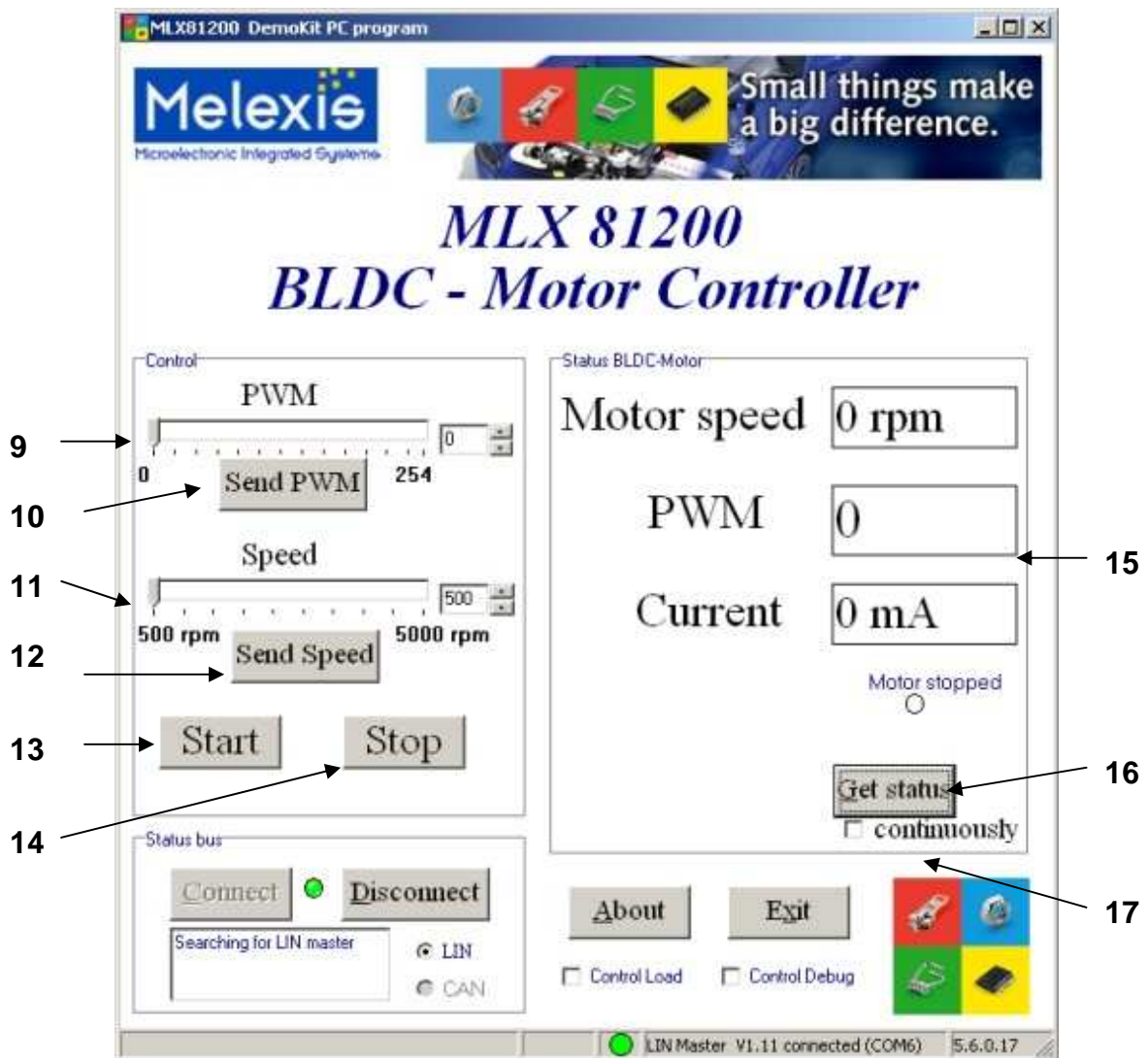

Fig. 22 Main window with connected LIN master

- | | |
|---|---|
| <p>9 Control bar "PWM"</p> <p>10 Button "Send PWM"</p> <p>11 Control bar "Speed"</p> <p>12 Button "Send Speed"</p> <p>13 Button "Start"</p> <p>14 Button "Stop"</p> <p>15 Status window</p> <p>16 Button "Get Status"</p> <p>17 Checkbox "continuously"</p> | <p>adjust the PWM value (send to MLX81200 with button 10)</p> <p>send the adjusted PWM value to the MLX81200</p> <p>adjust motor speed (send to MLX81200 with button 12)</p> <p>send the adjusted speed value to the MLX81200</p> <p>start the motor</p> <p>Note: The default speed target after start command is 1200U/min</p> <p>stop the motor immediately</p> <p>shows the current motor speed , PWM value , motor status and the current</p> <p>Note: If the CAN interface is used, the value of the current will not be transferred</p> <p>Click this button to get the actual status of the motor (shown in 15)</p> <p>Note: the received values of the PWM and speed will be transferred automatically to the control bars (9 and 11)</p> <p>get the motor status and send the target speed value every 150 ms.</p> |
|---|---|

8.4. Control Load window

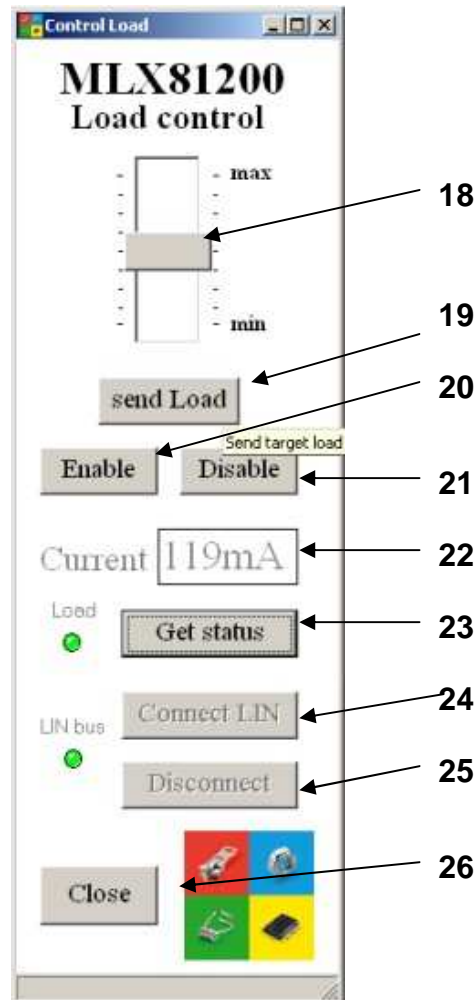

Fig. 23 Control Load window

- | | | |
|----|-------------------------|---|
| 18 | Control bar "Load " | adjust the load value (send to brake board with button 19) |
| 19 | Button "send Load" | send the adjusted load value to the brake board |
| 20 | Button "Enable" | switch the load on |
| 21 | Button "Disable" | switch the load off |
| 22 | Status window "Current" | shows the actual current of the load |
| 23 | Button "Get status" | click this button to get the actual current of the load (shown in 22) |
| 24 | Button "Connect LIN" | connect the LIN master if the CAN interface is used in main window |
| 25 | Button "Disconnect" | disconnect the LIN master |
| 26 | Button "Close" | close the window "Control load" and return to the main window |

8.5. Control Debug window

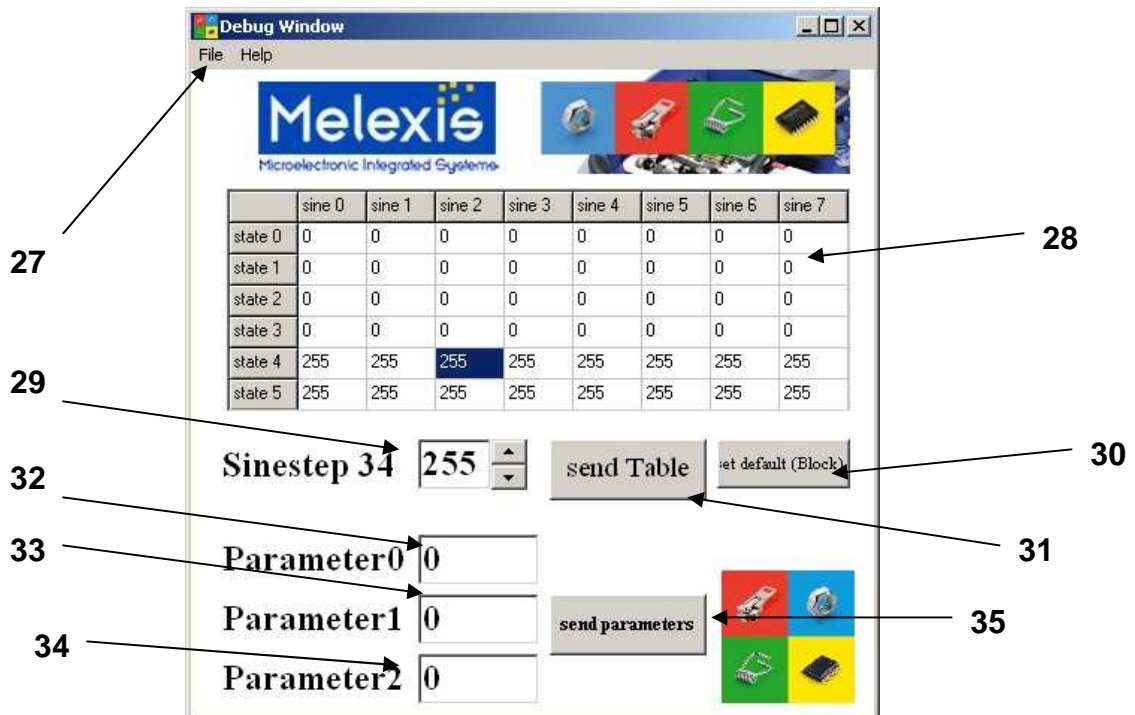

Fig. 24 Control Debug window

- | | | | |
|----|-----------------------------|---------------------|---|
| 27 | Pull down menu: | -“open table” | load a saved sine table |
| | | -“save table” | save the sine table |
| | | -“save table as...” | save the sine table to a selected path |
| | | -“close window” | close the debug window |
| 28 | Sine table | | each element can be chosen by mouse and modified with field 29 |
| 29 | Edit field “Sinestep” | | the value for each sine step can be modified direct or with up/down buttons |
| 30 | Button “set default(Block)” | | set the sine table to a default block |
| 31 | Button “send Table” | | send the table to the MLX81200 via LIN |
| 32 | Edit field “Parameter0” | | not used |
| 33 | Edit field “Parameter1” | | not used |
| 34 | Edit field “Parameter2” | | not used |
| 35 | Button “send parameter” | | not used |

8.6. PID controller and PC program

The firmware revision 1.6 for the MLX81200 BLDC DemoKit includes a PID controller.

After the button “Start” is pressed , the start algorithm begins to rotate the motor. After a defined number of motor states (ECM must be active), the PID controller is activated and the predefined target rational speed is set up by the PID controller. Every time the button “Send PWM” is used to change the PWM value of the motor, the PID controller is disabled and only the adjusted PWM is used by the firmware. The PID controller can be reactivated by sending a new speed target to the MLX81200.

9. Appendix

9.1. Schematics of the Evaluation Board

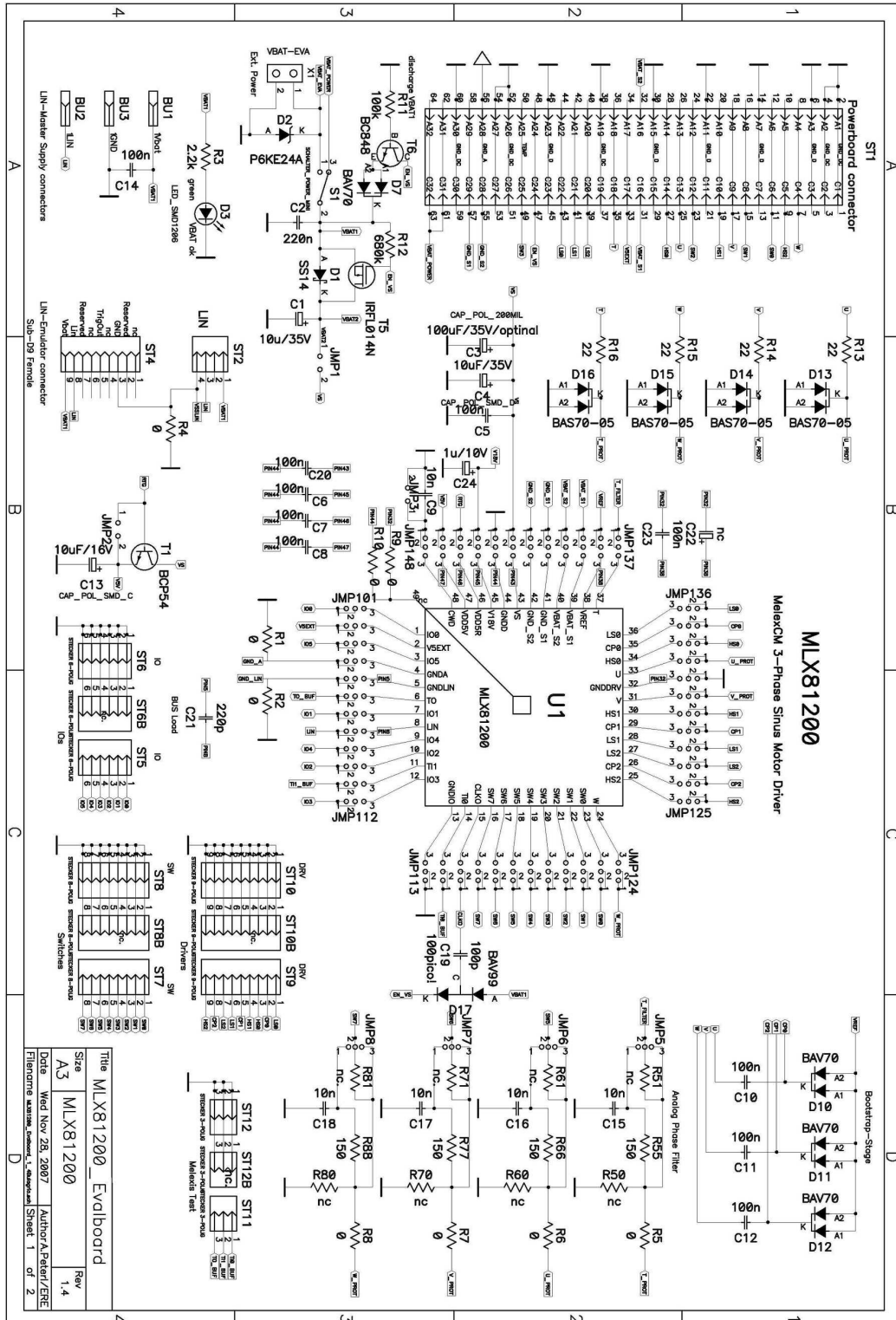

Fig. 25 Schematics of the Evaluation board

9.2. Schematic of the Evaluation Board – Part 2 Programmer Interface

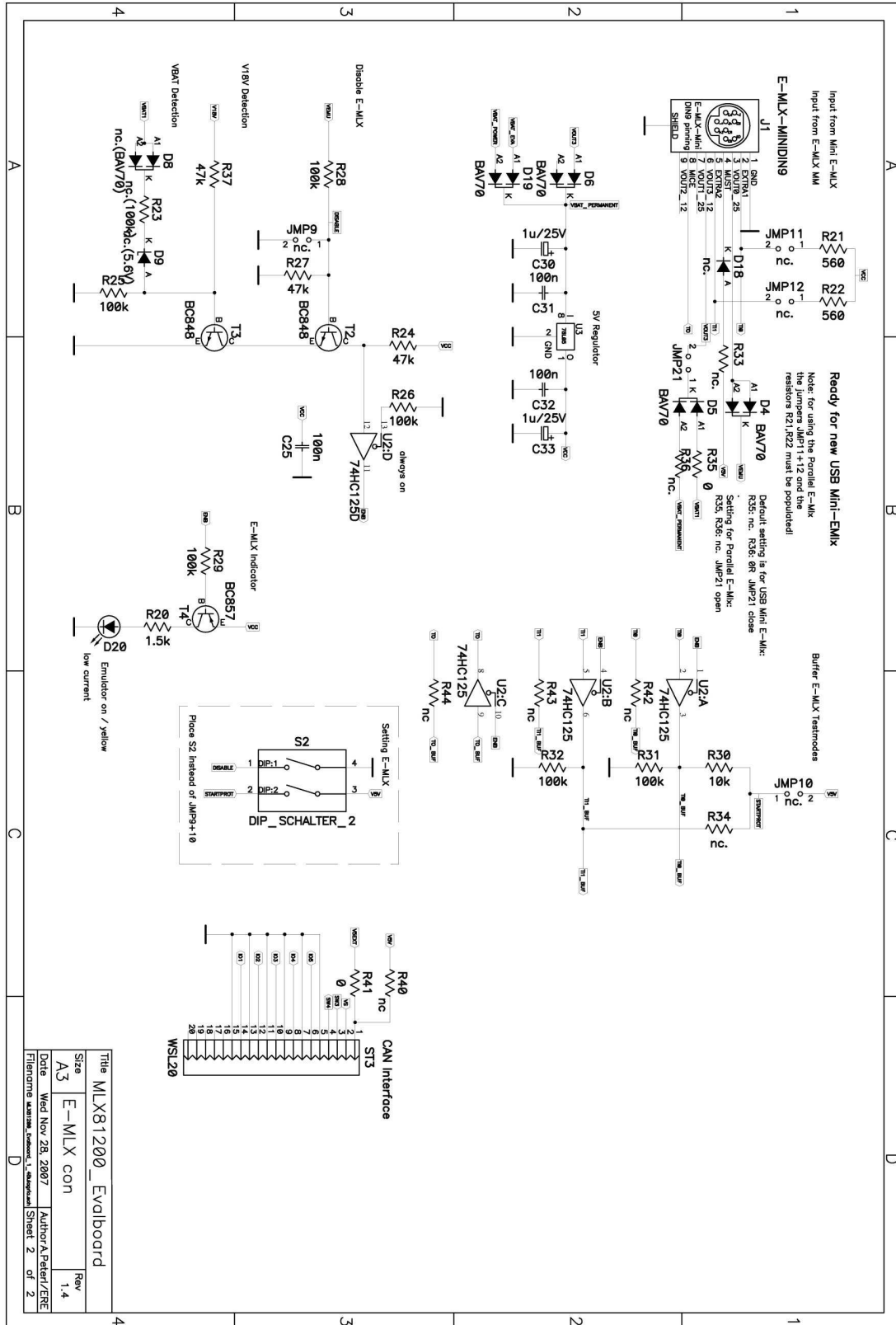

Fig. 26 Schematics of the Programmer board

9.3. Schematic of the Power Board

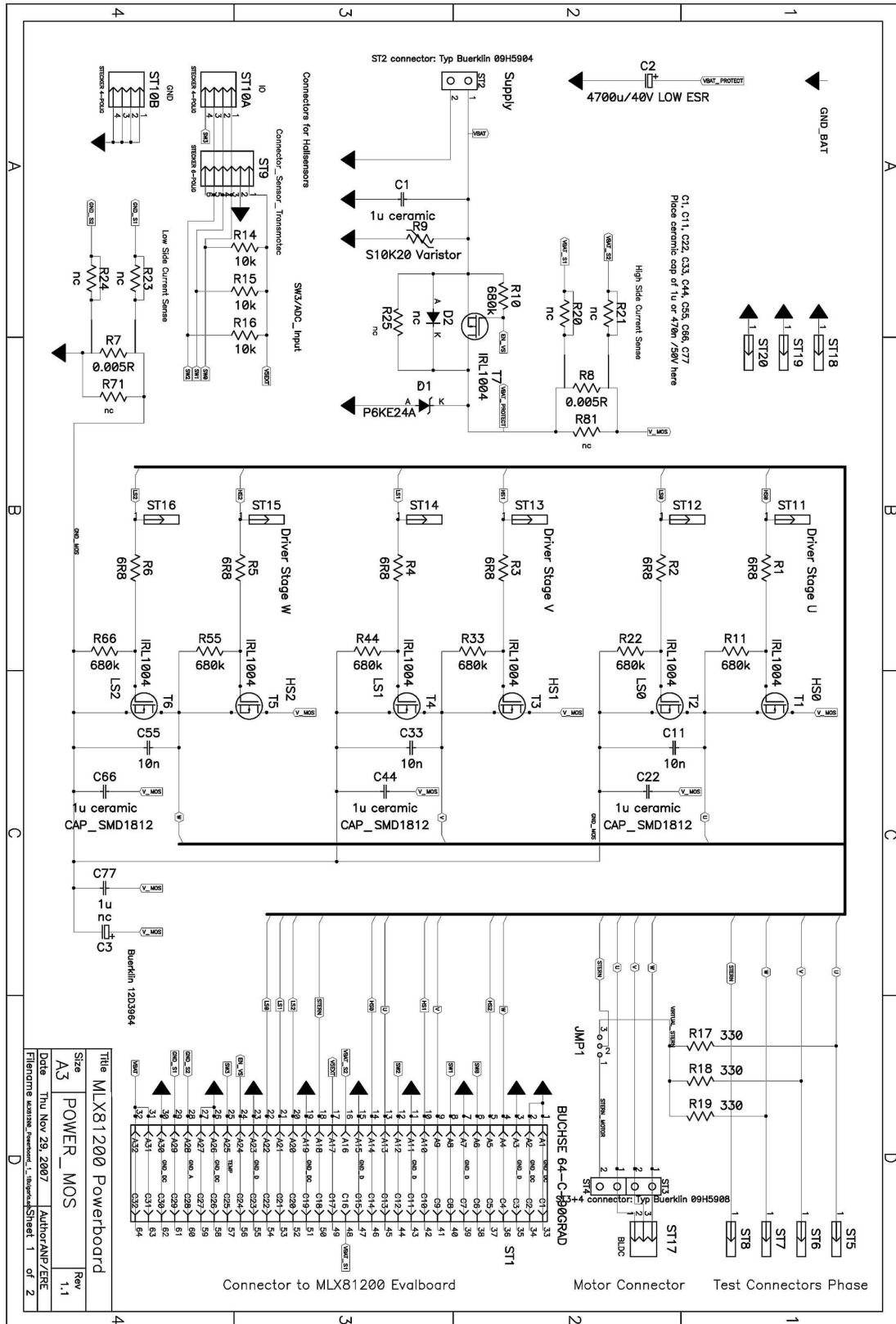

Fig. 27 Schematics of the Evaluation board

10. History record

Rev.	No.	Change	Date
1.0	1	Creation of document	20/Dec/06
1.1	2	Changed description from EMLX-MM programmer to Mini E-MLX and adapted to hardware revision EVB rev1.4 and Powerboard rev1.1	13/Feb/08
1.2	3	Add chapter 7 BLDC DemoKit PC program	1/May/08
1.3	4	Add chapter 7 MLX81200 Software configuration tool	24/Okt/08
1.4	5	Add chapter "8.2 Command line parameter", adapted new SW structure and add chapter "7.4.1 Configure the hardware in use"	05/Nov/08

11. Disclaimer

Devices sold by Melexis are covered by the warranty and patent indemnification provisions appearing in its Term of Sale. Melexis makes no warranty, express, statutory, implied, or by description regarding the information set forth herein or regarding the freedom of the described devices from patent infringement. Melexis reserves the right to change specifications and prices at any time and without notice. Therefore, prior to designing this product into a system, it is necessary to check with Melexis for current information. This product is intended for use in normal commercial applications. Applications requiring extended temperature range, unusual environmental requirements, or high reliability applications, such as military, medical life-support or life-sustaining equipment are specifically not recommended without additional processing by Melexis for each application.

The information furnished by Melexis is believed to be correct and accurate. However, Melexis shall not be liable to recipient or any third party for any damages, including but not limited to personal injury, property damage, loss of profits, loss of use, interrupt of business or indirect, special incidental or consequential damages, of any kind, in connection with or arising out of the furnishing, performance or use of the technical data herein. No obligation or liability to recipient or any third party shall arise or flow out of Melexis' rendering of technical or other services.

© 2008 Melexis NV. All rights reserved..

For the latest version of this document, go to our website at:

www.melexis.com

Or for additional information contact Melexis Direct:

Europe and Japan:
Phone: +32 1367 0495
E-mail: sales_europe@melexis.com

All other locations:
Phone: +1 603 223 2362
E-mail: sales_usa@melexis.com

ISO/TS 16949 and ISO14001 Certified