



## Human Interface Solutions



# Human Interface Solutions

*Adding a modern, intuitive user interface to your design improves its ease-of-use, functionality and aesthetics. Graphics displays, touch interactivity and audio prompts add a modern, updated look and feel to any design.*

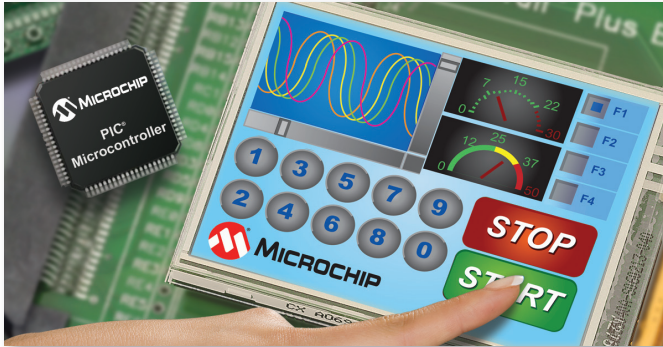

Engineering teams that are tasked with creating human interfaces for new or legacy designs need solutions that create a high-impact user interface incorporating the latest in touch sensing and graphical display technologies. These solutions must be easy to integrate and lower total system cost.

Touch sensing interfaces such as keys/sliders and touch screens are fast becoming an alternative to traditional push button switch user interfaces owing to their many benefits—elegant and stylish designs, lower manufacturing costs achieved by lowering costs of molds, tooling and assembly, and increased reliability via fewer moving components. Application designers migrating to touch sensing interfaces require robust, low-cost and power-efficient solutions that are easy to integrate.

Digital displays improve the user interface of just about any application. Segmented LCDs have historically been a popular choice of display technology and continue to grow in a variety of medical and industrial applications. In recent years there has been a significant rise in the use of graphical displays such as TFT, OLED and CSTN in consumer, appliance and automotive applications. Users prefer intuitive menus, vivid graphics, touch panel interaction and in some case the ability to interact remotely with a system. Designers migrating toward graphical displays face several challenges such as cost of components associated with driving the display, complexity of software needed for updating graphics, battery life and remote connectivity.

If you are looking to add newer and feature-rich interfaces to your products in an aesthetically pleasing manner, Microchip has a broad portfolio of solutions that include touch sensing and display technologies. Microchip delivers these latest advancements as complete hardware and software solutions to get your design to market faster at a lower total system cost.

## Key Highlights

### Touch Sensing Solutions

#### Keys & Sliders

- Longer battery life with eXtreme Low Power MCUs
- Sensing through metal, plastic or glass
- High noise immunity and low emissions
- Lower system cost with broad MCU portfolio
- Free software library enables easy integration and touch-sensing GUI speeds up development
- Get started quickly with low cost development kits

### Touch Screen Controllers

- Turnkey analog resistive controllers for lowest system cost
- Highly flexible projected capacitive solution with low cost MCU implementation
- Fully processed and reliable touch coordinates
- Multi-touch and gesture capable
- Low power solutions with wide operating voltage
- Royalty-free source code solutions with complete starter kits

### Display Controller Solutions

#### Segmented LCD

- Direct drive of inexpensive displays
- Up to 480 segments
- Integrated analog for sensor applications like temperature sensing in thermostats
- Integrated touch sensing function

#### Graphical Displays

- Up to WVGA (800x480) resolution
- Up to 24 bit per pixel
- Free Graphics Library and Graphics Display Designer GUI
- PIC24 “DA” family features integrated graphics acceleration and display controller
- High performance 32-bit MCUs with integrated Ethernet and CAN for remote interfaces
- Integrated USB OTG and mTouch sensing

### Audio Processing Solutions

- Generation of tones, alarms and musical notes
- Recording and playback of audio information
- Graphic equalizer



# mTouch™ Sensing Solutions

Expanding beyond the consumer market, touch sensing is now taking hold in medical, industrial and automotive applications. Examples include:

- Battery applications: automotive, cell phones, medical devices, remote controls and thermostats
- Line-powered applications: home appliances, printers, set top boxes, smart energy monitors and television

Microchip offers a broad portfolio of low power, low cost and flexible solutions to enable two types of touch-sensitive interfaces:

- Keys and sliders
- Touch screen controllers

## mTouch Solutions: Keys, Sliders and Proximity



Touch sensing technology gives the freedom to be more creative with various design elements including shape and style. It allows translating mechanical push button features into features such as

keys and sliders. Therefore, higher reliability, due to lesser moving parts, will come with a lower cost. Other features such as proximity sensing and gesture recognition can easily be implemented. Time to market is also faster for the Touch system due to lower design complexity & minimal stack ups.

Microchip's mTouch sensing solutions enable designers to easily design and integrate touch technologies into their applications. The mTouch sensing solutions are proven and used in many applications worldwide due to its superior noise robustness, no additional external component requirements, ease of implementation and the range of products that can be used to implement touch sensing. Our unique open philosophy gives customers a proven software library that allows easy integration of their application.

## Lowest Power

mTouch solutions offer longer battery life and lower standby current. Using award-winning eXtreme Low Power technology, mTouch solutions bring you the industry's lowest power consumption for touch-sensing.

- Capacitive sensing in less than 5  $\mu\text{A}$
- Proximity sensing down to 1  $\mu\text{A}$
- MCU Sleep current down to 9 nA
- MCU Active current down to 50  $\mu\text{A}/\text{MHz}$
- MCU Real-time Clock down to 470 nA

## Broad MCU Portfolio

Microchip offers a variety of PIC MCUs enabling you to dedicate an MCU for touch function or integrate touch sensing with other application functions onto a single MCU:

- 8, 16 and 32-bit PIC MCUs for touch sensing
- 6-pin to over 100-pin devices
- Up to 512 KB Flash memory
- High noise immunity and low emissions: IEC61000, EFT, BCI
- On-chip integration options include USB, CAN, IrDA, wireless protocol stack, segmented LCD and graphics accelerator and LCD driver for TFT/STN displays
- Up to 32 capacitive touch channels
- No external components needed

## Dedicated Touch Controllers (PIC10/12/16/18)

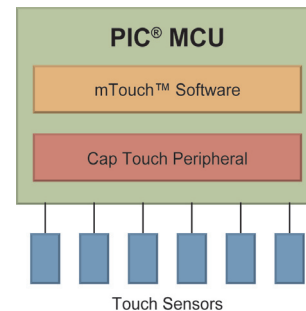

## Highly Integrated Touch Controllers (PIC16/18/24/32)

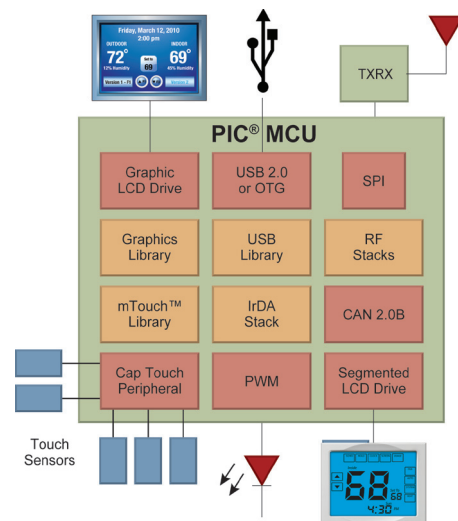

## Capacitive Touch Sensing

The capacitive touch sensor is a copper pad area, that is capacitively coupled to grounds located elsewhere in the system creating a parasitic capacitance. A covering plate material such as glass is used to provide the user touch surface. The introduction of the user's finger then produces an increase in capacitance which will be detected by the system.

# mTouch Sensing Solutions

## Metal Over Cap Technology

mTouch capacitive touch solutions allow users to work with a variety of plastic or glass overlays to finish their user interface designs. With metal over cap technology users can also:

- Use polished or brushed metal surfaces including stainless steel and aluminium
- Sense through gloves
- Create water-proof designs
- Deploy Braille-friendly interfaces

## How Metal Over Cap Technology Works

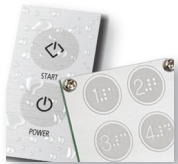

The front panel and the sensor create a capacitor. When the user presses the key, the distance between both plates will decrease slightly, increasing the capacitor value. Thanks to their high SNR (Signal to Noise Ratio) and stability over voltage and

temperature, mTouch sensing solutions allow the detection of deflection as low as 10  $\mu\text{m}$ .

Metal Over Cap Technology can be implemented with the same hardware, PCB and electronics, and SW as capacitive touch technology.

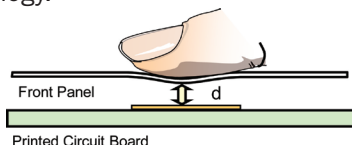

## Development Tools for Capacitive Touch

### Enhanced mTouch Capacitive Evaluation Kit (DM183026-2)

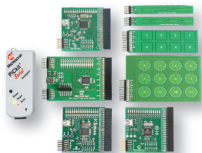

The Enhanced mTouch Capacitive Evaluation Kit provides a simple platform for developing a variety of capacitive touch sense applications using 8, 16 and 32-bit PIC microcontrollers. The kit contains:

- 8-key sensor board direct interface
- 12-key matrix sensor board
- 4-channel slider sensor board
- 2-channel slider sensor board
- Four PIC MCU processor boards:
  - PIC16F1937, PIC18F46J50, PIC24FJ64GB106 and PIC32MX795F512H
- Diagnostic GUI to analyze touch sensor data real-time via USB
- PICKIT™ Serial Analyzer

Additional available processor boards:

- PIC24H mTouch Capacitive Touch Evaluation Board\* (AC243026)
- PIC32 CTMU Evaluation Board (AC323027)

## Metal Over Cap Accessory Kit (AC183026)

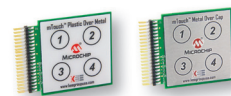

- The AC183026 kit contains two daughter boards showcasing Metal Over Cap technology. One board has a stainless steel cover while the other one has a plastic one.

- It provides an easy way to evaluate Microchip's unique technology, when used in conjunction with the mTouch Capacitive Touch Evaluation Kit (DM183026-2).

## mTouch Software Package

Microchip provides a fully developed and tested SW package. It features:

- Source code available
- Keys, slider and wheel support
- Matrix
- Proximity detection with specific algorithm offering great range and low power
- Available for 8,16 and 32-bits
- Low Power
  - Capacitive sensing in less than 5  $\mu\text{A}$
  - Proximity sensing down to less than 1  $\mu\text{A}$
- Gesture
- Several output mode like direct or toggle mode as well as serial communication
- Easy to integrate with Microchip libraries such as Graphics or USB
- Two way communication with PC or Master
- Works with PCB or ITO sensors

Specific noise features include:

- High Signal to Noise Ratio (SNR)
- Differential touch sensing mode
- Adjacent button rejection or "most-pressed" options
- Active Guard Ring support
- Self and mutual measurement
- Automatic environmental compensation
- Various proprietary noise filtering algorithms

## Application Notes for mTouch

- *Techniques for Robust Capacitive Touch Sensing*, AN1334
- *mTouch Metal Over Cap Technology*, AN1325
- *mTouch Conducted Noise Immunity Techniques for CTMU Peripheral*, AN1317
- *Capacitive Touch Using Only an ADC (CVD) (suitable for PIC10/12/16/24H/32 MCUs)*, AN1298
- *Microchip CTMU for Capacitive Touch Applications (suitable for PIC18 and PIC24F MCUs)*, AN1250
- *Capacitive Touch Algorithm Simulation*, AN1254

\*Code also supports dsPIC33 DSC.

# mTouch Sensing Solutions: Touch Screen Controllers



Microchip offers a broad portfolio of advanced touch solutions for projected capacitive and resistive touch screen applications with the following advantages:

- **High Flexibility:** Royalty free source code model, increased design flexibility with options to integrate touch sensing with application code on a single MCU, low cost, low power solutions to reduce total system cost.
- **Sophisticated:** Advanced touch screen solutions use sophisticated proprietary touch screen decoding algorithms to send your application fully processed and reliable touch coordinates.
- **Easy Integration:** Designers can add touch screen technology to their application without extensive development time, risk or cost.

## Projected Capacitive vs. Resistive

Microchip presents both projected capacitive and resistive touch solutions to allow designers to choose the best fit for their touch screen design.

- Projected capacitive technology provides high durability, good optics and multi-touch capability which enable gestures.
- Resistive touch is a good choice for a low cost, easy to integrate solution that accepts finger, stylus or glove input.

## Touch Sensing Technology Comparison

	Analog Resistive	Projected Capacitive
Cost for screen < 6"	Lowest	Low
Cost for screen > 10"	Lowest	High
Optics	75%	90%
Screen Life	Good	Better
Ease of Integration	Easy	Moderate
Multi-Touch	Limited	Yes
Touch Object	Finger, Stylus/ Glove	Finger

## Analog Resistive Technology

### Microchip's AR1000 Series Key Features

- Frees host from burden of touch data processing
- Enables supply chain optimization via universal sensor support
  - Turnkey touch solution
  - Built-in decoding and advanced filtering—no touch code to write
  - Power-saving sleep and external wake up modes
  - Universal 4, 5 and 8 wire sensor support
  - SPI, I<sup>2</sup>C™, UART or USB interfaces
  - 4 × 4 QFN package
  - Free drivers for most major platforms

### How Analog Resistive Works

- Two conductive coated polyester layers separated by a spacer layer
- When touched, top (flex) layer moves past spacer layer and contacts bottom (stable) layer
- Point of contact creates voltage divider in the X and Y directions

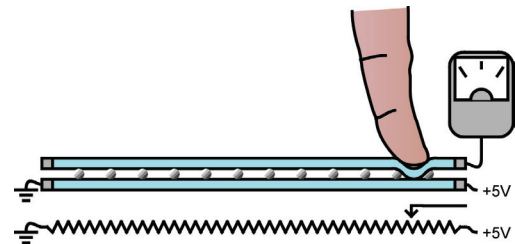

## Development Tools for Resistive Touch

### mTouch AR1000 Development Kit (DV102011)

- UART output (AR1011)
- SPI or I<sup>2</sup>C output (AR1021)
- Low cost with advanced touch functionality
- Communication support for I<sup>2</sup>C/SPI/UART
- Built in decoding and advanced filtering

### mTouch AR1100 Development Kit (DV102012)

- Auto detect USB or UART Communication (AR1100 Chip)
- Auto detect USB or RS-232 Communication (AR1100 Board)
- Low cost, high performance USB resistive
- USB and advanced 9 and 25 point calibration
- USB mouse or single touch win 7 digitizer
- Field flash updatable (UART and USB)
- Chip and board product for fast integration

# mTouch Sensing Solutions: Touch Screen Controllers

## Projected Capacitive Technology

Microchip's projected capacitive technology is the first in a series of patent-pending releases supporting projected capacitive touch screen solutions across the portfolio of 8-, 16- and 32-bit PIC MCUs. Microchip makes it easy for designers to integrate Projected Capacitive interfaces with flexible, royalty-free source code and software support tools, to enable fast time to market.

## How Projected Capacitive Works

- One or two thin layers of glass patterned with conductive coating, typically Indium Tin Oxide (ITO)
- Screen is configured as rows and columns
- Point of contact identified by change in capacitance of row and column cells

## Development Tools for Projected Capacitive Touch

### Projected Capacitive Development Kit (DM160211)

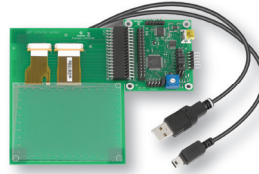

- Multi-touch support
  - Enables gesture navigation for intelligent control
- High flexibility
  - Royalty-free source code license
- Integrate touch sensing with application code on a single MCU
- Low power
  - Also available on XLP devices
- Low cost solution

## Applications

- Embedded systems
- Appliances
- Automotive, GPS and navigation devices
- Gaming, consumer electronics, mobile devices
- Security control panels
- Remote controls
- Thermostats

## Implementation of Projected Capacitive Touch

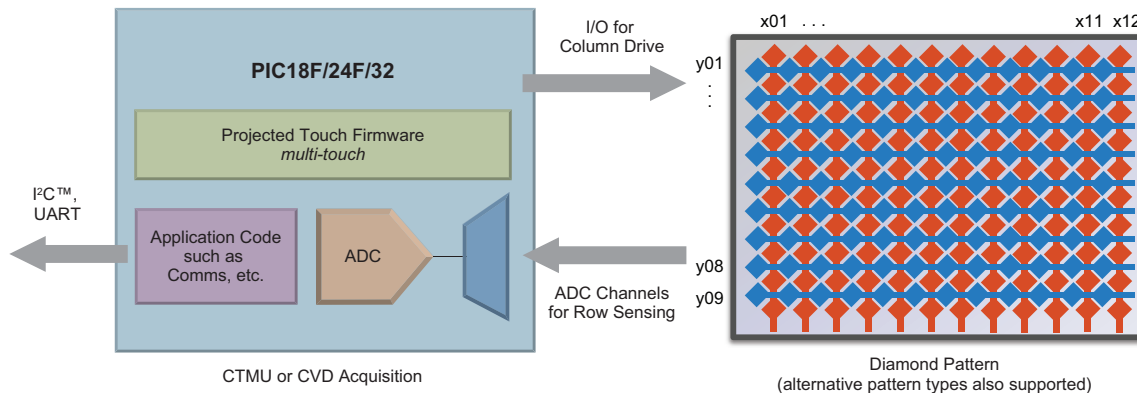



# Display Controller Solutions: Segmented LCD

## Display Solutions for Segmented LCD

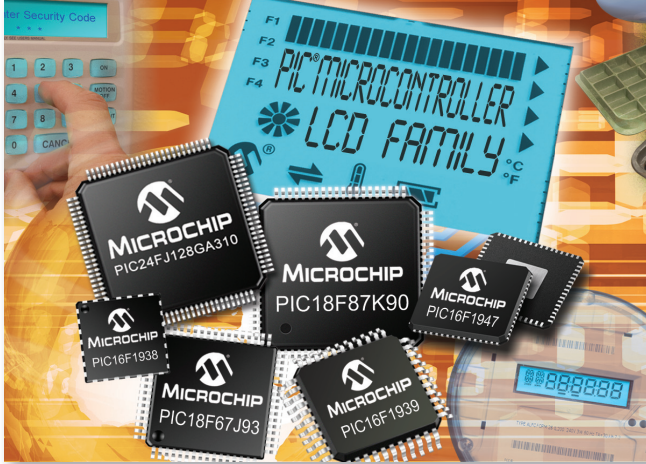

Segmented displays are used in a wide variety of applications, ranging from meters to portable medical devices to thermostats to exercise equipment. PIC microcontrollers with integrated LCD drivers can directly drive segmented displays with letters, numbers, characters and icons. The main features of Microchip's LCD portfolio include:

- Flexible LCD segments
  - 28 pins, up to 60 segments
  - 44 pins, up to 116 segments
  - 64 pins, up to 240 segments
  - 80 pins, up to 368 segments
  - 100 pins, up to 480 segments
- Variable clock inputs
- Integrated voltage bias generation
- Direct drive for both 3V and 5V powered displays
- Software contrast control for boosting or dimming for different temperature or lighting conditions
- Drive LCD while conserving power in Sleep mode
- Integrated real time clock and calendar for displaying time and date information
- mTouch capacitive touch sensing capability

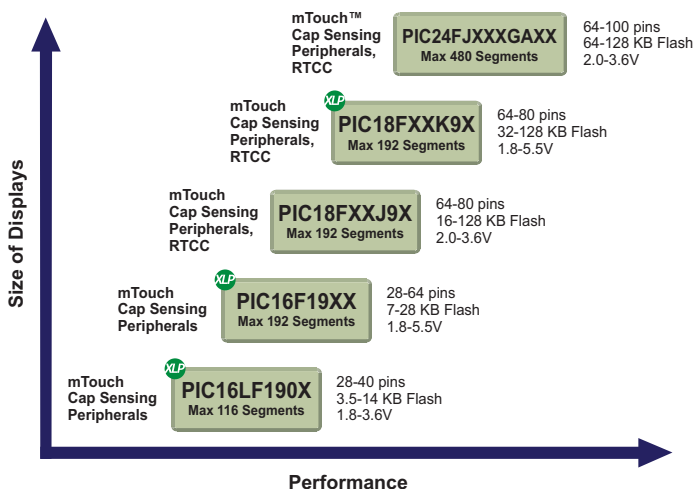

## Direct Drive for Segmented Displays

The LCD PIC microcontrollers support direct LCD panel drive capability with no external components needed, lowering total system cost. They have integrated voltage bias generation which allows the MCU to generate the different voltage levels that are required to drive the LCD segment pins and provide good contrast for the display. The LCD MCUs support a range of fixed and variable bias options as well as variable clock inputs that enable the flexibility to work with many different glass vendors.

## Contrast Control

Software contrast control is a key feature using firmware to either boost or dim the contrast of the display. Boost the contrast up to  $V_{DD}$  or beyond if you are using one of the MCUs with an integrated charge pump. Software contrast control allows the designer to vary the contrast on the LCD to account for different operating conditions such as temperature, lighting and humidity. Also, software contrast control can be invaluable for portable applications. As the battery level starts to drop, the firmware can apply a boost to the contrast, helping extend the battery life while still seeing a crisp image on the display.

## Development Tools for Segmented LCD

### LCD Explorer Development Board (DM240314)

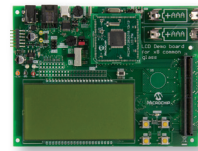

- Supports Microchip's 100-pin microcontrollers with  $\times 8$  common segment LCD drivers
- Provides an ideal platform to evaluate a MCU with a  $\times 8$  Common LCD Driver on a 38 segment  $\times 8$  common LCD display
- PICtail™ Plus connections enable evaluation of selected MCUs in a complex system by adding PICtail Plus daughter boards

### PICDEM™ LCD 2 Demo Board (DM163030)

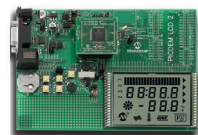

- Illustrates and supports the main features of Microchip's 28, 40, 64 and 80-pin LCD PIC microcontrollers
- LCD glass with icons, numbers, alphanumeric and starburst display
- Demonstrates booster capability for contrast control and dimming

■ Separate Processor Plug-in Modules (PIMs) are available to evaluate all of the LCD products

- PIC18F87J90 PIM (MA180025)
- PIC18F87K90 PIM (MA180027)
- PIC16F1947 PIM (MA160016)
- LCD PIM Pack (PIC16) (MA180019)

## Application Notes for LCD Displays

- *Low Power Techniques for LCD Applications*, TB1098
- *Implementing an LCD Using the PIC16F1947 Microcontroller*, AN1354

# Display Controller Solutions: Graphical Displays



Microchip offers varying levels of solutions to drive everything from simple monochrome LCDs to full color WVGA user interfaces.

Graphics support includes the following approaches:

- PIC24F “DA” integrated graphics controller
- PIC32 controllerless graphics
- Support for PIC MCU with external graphics controllers

The silicon offering is complemented with powerful, free and easy to use graphics library, display designer GUI and hardware development kits with flexible interface to various glass sizes.

## FREE Microchip Graphics Library

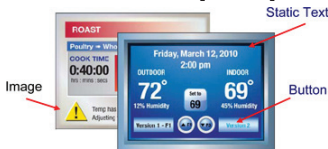

The Microchip Graphics Library is highly modular and is optimized for Microchip’s 16- and 32-bit microcontrollers. It is easy to use and has an open

documented interface for driver or controller support. The library supports the following features:

- Pre-made graphics objects
- Multiple fonts and languages
- User interface for mTouch™ sensing
- Includes buttons, charts, check boxes, scroll bars, list boxes, images and basic animation

## FREE Microchip Graphics Display Designer

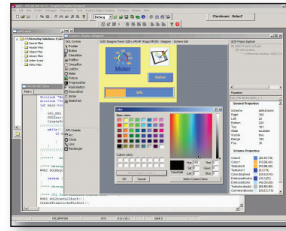

The Microchip Graphics Display Designer (GDD) is a visual design tool that provides customers with a quick and easy way of creating Graphical User Interface (GUI) screens for graphical interface applications on Microchip MCUs.

It provides the following advantages to the developers:

- Simplifies coding for the GUI screens with an ability to draw, resize and delete screen objects
- Eliminates the need to manually calculate the x- and y-coordinates for on-screen object placements
- Generates output source files
- Ability to import various graphical resources, including custom fonts and bitmap images

## Supported Screen Sizes and Colors

Microchip graphics solutions support various screen sizes and colors ranging from small monochrome OLED displays up to WVGA displays with vivid color. The table below shows the bits per pixel required to represent color.

Display Representation	Color Examples	Color Depth (bits per pixel)
Mono	Black and White	1
Grayscale	4 shades	2
	16 shades	4
Color	256 colors	8
	65K colors	16
	16 million colors	24

As the color depth and display resolution increase, the frame buffer grows. Depending on the size, the frame buffer can be stored in the microcontroller RAM, in external SRAM or integrated into an external graphics controller. The table below shows examples of the frame buffer sizes required for some popular resolution and color depths.

- PIC24 “DA” family supports up to 96 KB on chip
- PIC32 MCUs support up to 128 KB on chip
- External SRAM can be used for larger frame buffers
- For advanced graphics, external graphics controllers have additional frame buffer storage

Display Resolution Typical Sizes			Color Depth/ Memory Requirement in (bytes)				
			1 bpp (Mono)	2 bpp (4 shades)	4 bpp (16 shades)	8 bpp (256 colors)	16 bpp (65K colors)
WVGA	800 × 480	7"	48,000	96,000	192,000	384,000	768,000
VGA	640 × 480	5.7"	38,400	76,800	153,600	307,200	614,400
WQVGA	480 × 272	4.3"	16,320	32,640	65,280	130,560	261,120
QVGA	320 × 240	3.2"	9,600	19,200	38,400	76,800	153,600
Common for OLED	128 × 64	1"-2.7"	1,024	2,048	4,096	8,192	16,384

Internal PIC® MCU SRAM      External SRAM



# Graphical Display Configurations

## Target Applications

Applications that benefit from attractive and easy to use graphical displays include:

**Consumer:** Thermostats, Cordless Phones, Remote Controls

**Home Appliance:** Coffee Makers, Washing Machines, Ovens

**Industrial:** Digital Instrument Gauges, Storage Controls, Remote Terminals

**Portable Medical:** Glucometers, Blood Pressure Monitors, Portable ECGs

## Application Notes & Documentation for Graphical Displays

- *Fonts in the Microchip Graphics Library*, AN1182
- *How to Use Widgets in Microchip Graphics Library*, AN1136
- *How to Create Widgets in Microchip Graphics Library*, AN1246
- *Using a Keyboard with the Microchip Graphics Library*, AN1227
- *Developing Graphics Applications using an MCU with Integrated Controller*, AN1368
- *Using PIC32 MCUs to Develop Low-Cost Controllerless (LCC) Graphics Solutions*, AN1387
- *Graphics Quick Reference Guide*, DS01394

## PIC24F with Integrated Graphics Controller: Low Cost, Easy to Use

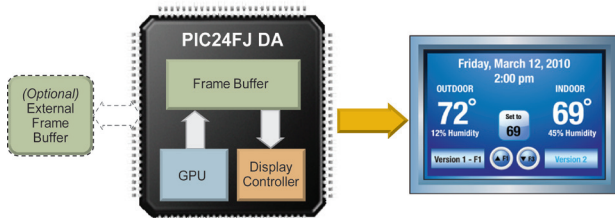

The PIC24F “DA” family makes it easy and cost-effective to add advanced graphics to your application by eliminating the need for external frame buffers or display controllers.

- Dedicated graphics clock for a continuous, clean display
- On-chip display controller provides direct interface to TFT, STN and OLED displays
- Easy to use Graphics Processing Units for hardware acceleration
  - Move and copy rectangles with smooth, fast memory transfers
  - Decompress images without CPU intervention
  - Render text without CPU intervention
- Color look-up table and 96 KB frame buffer to support multiple colors
  - Supports QVGA 8 bpp with internal frame buffer
  - Supports WQVGA 16 bpp with external frame buffer using PMP (Parallel Master Port)

With the hardware acceleration, this family is able to process and render graphics without using any MCU MIPS. The dedicated graphics engine is able to continuously drive a display without being shared with any other function.

## PIC32 Low Cost Controllerless Graphics: 32-bit Performance, Flexibility, Integration

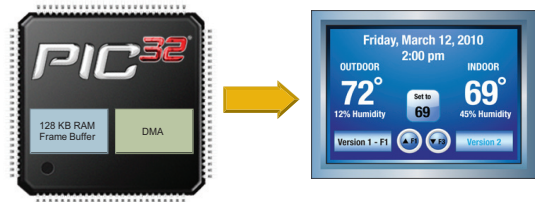

Microchip's PIC32 line of 32-bit microcontrollers offers 80 MIPS and high performance DMA to render graphics directly to displays. This enables PIC32 devices to drive a display without an external graphics controller.

- Uses <5 MIPS and DMA to render graphics
  - Direct interface to STN, TFT displays
- Integrated 128 KB RAM for frame buffering
  - Supports QVGA 8 bpp with internal memory
  - Supports WQVGA 16 bpp with external SRAM using PMP (Parallel Master Port)
- Works with any PIC32 80 MIPS 32-bit microcontroller

With devices offering up to 512 KB Flash and 128 KB RAM, developers have plenty of space for application code, communications stacks and data buffering. In addition to the graphics capabilities, PIC32 MCUs also have integrated peripherals for USB, CAN, Ethernet and capacitive touch sensing.

## External Graphics Controller: PIC24 or PIC32 with Parallel Master Port (PMP)

PIC24 and PIC32 MCUs can also work with an external graphics controller to support larger screen sizes or more advanced graphical features. Many external graphics controllers are supported by the graphics library; a few that we support with development tools are highlighted below.

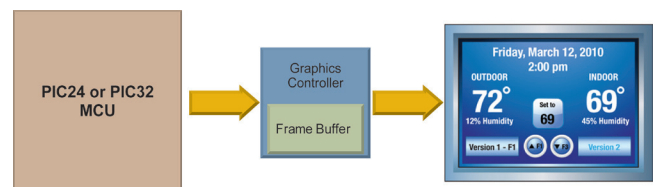

**The Solomon Systech SSD1926 Graphics Controller** has hardware graphics acceleration to free up the MIPS of the PIC MCU. This controller includes a SD Card interface and JPEG decode engine as well as 256 KB RAM. The Graphics PICtail™ Plus SSD1926 Board (AC164127-5) includes serial Flash for data storage and interfaces to either Explorer 16 or PIC32 Starter Kits.

**The Epson S1D13517 Graphics Controller** includes alpha blending, picture-in-picture and supports up to WVGA (800x480) at 24 bpp. This controller has an SDRAM interface for connection to low cost external memory. The Graphics Controller PICtail Plus Epson S1D13517 Board (AC164127-7) includes 128 Mb SDRAM frame buffer and 64 Mb serial Flash and interfaces to either Explorer 16 or PIC32 Starter Kits.

# Tools for Designing Graphical Displays

	PIC24 "DA" Integrated Graphics Controller	PIC32 Controllerless Graphics	External Solomon Systech Graphics Controller SSD1926	External Epson Graphics Controller S1D13517
Display*	WQVGA 480 × 272	WQVGA 480 × 272	WQVGA 480 × 272	WVGA 800 × 480
Graphics	HW Acceleration: Rectangles, Characters, Images	DMA on PIC32 + <5 MIPS	HW Acceleration, SD card, I/F, JPEG engine	SDRAM, I/F, Alpha-blending, Picture-in-picture
Frame Buffer	Color Lookup Table + 96 KB on MCU + Ext SRAM	128 KB on MCU + Ext SRAM	256 KB on Solomon Systech Controller	Ext SDRAM
Core MIPS	16	80	–	–
Power	Better	Good	Good	Good
Cost	\$	\$	\$\$	\$\$\$

\*Max size at 16 bpp, 60 Hz

## Development Tools for Graphical Display Controllers

### Low Cost Solution Without External Graphics Controller

### Solutions with External Graphics Controllers

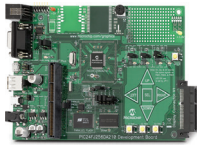

**PIC24FJ256DA210**  
Development Board  
(DM240312)



**Low-Cost Controllerless (LCC) Graphics PICtail™ Plus Board (AC164144)**



**Graphics LCD Controller PICtail™ Plus SSD1926 Board (AC164127-5)**  
(Includes Solomon Systech SSD1926 Controller)



**Graphics Controller PICtail™ Plus Epson S1D13517 Board (AC164127-7)**



**Multimedia Expansion Board (DM320005)**  
(Includes Solomon Systech SSD1926 Controller)

Family	Display Boards Supported				
	QVGA 3.2" Graphics Display Truly 240 × 320 Board (AC164127-4)	WQVGA 4.3" Graphics Display Powertip 480 × 272 Board (AC164127-6)	VGA 5.7" Graphics Display Truly 640 × 480 Board (AC164127-8)	WVGA 7" Graphics Display Truly 800 × 480 Board (AC164127-9)	Prototype Boards Connect Your Glass (AC164139)
<b>PIC24 "DA" Family</b>	PIC24FJ256DA210 Board (DM240312) + Display Board		*		Yes
<b>PIC32 "LCC" Graphics</b>	PIC32 Starter Kit (DM320001 or DM320003) + LCC Graphics Board (AC164144) + Display Board		*		Yes
<b>PIC24 + Solomon Systech SSD1926</b>	Explorer 16 (DM240001) + Solomon Systech GFX Board (AC164127-5) + Display Board				Yes
<b>PIC32 + Solomon Systech SSD1926</b>	PIC32 Starter Kit (DM320001 or DM320003) + Multimedia Expansion Board (DM320005) Display Integrated on MEB				
<b>PIC32 + Solomon Systech SSD1926</b>	PIC32 Starter Kit (DM320001 or DM320003) + Solomon Systech GFX Board (AC164127-5) + Display Board				Yes
<b>PIC24 + Epson S1D13517</b>	Explorer 16 (DM240001) + Epson GFX Board (AC164127-7) + Display Board				Yes
<b>PIC32 + Epson S1D13517</b>	PIC32 Starter Kit (DM320001 or DM320003) + Epson GFX Board (AC164127-7) + Display Board				Yes

\*These configurations will only work at 8 bpp, 60 Hz or 16 bpp, 30 Hz.  
All other recommendations based on 16 bpp, 60 Hz performance on PIC® MCU

# Speech & Audio Solutions

Audio provides a means of communication, improves ease of use and delivers entertainment. It can transform the mood of an environment, help us escape a noisy commute, assist us in machine interface or improve the quality of life for the visually impaired. Bringing audio to your application enhances its ability to meet the needs of your customers. Bringing your product to market with the right mix of performance and price in the timeliest manner is important to your business. Microchip provides microcontrollers, development platforms and free software source code to help you bring a cost effective design to market in the shortest time possible.

## Featured Products

Most 8/16/32-bit PIC microcontrollers can generate tones, alarms and musical notes in various applications. The dsPIC DSCs and PIC32 MCUs have DSP libraries included in their respective compilers to enable higher performance and more efficient processing of high quality audio. Many devices now offer I<sup>2</sup>S/SPI modules for more convenient CODEC interface. The PIC32MX1/MX2 Series of MCU's offer CODEC master clock support with very fine control for reduced CODEC cost and audio buffer management.

## Audio Application Support

Functions	Development Board	Accessories	Device Families Supported	Key Features	Libraries Supported
Recording & Playback	Audio Development Board for PIC32 MCUs (DM320011)	MFi PICTail™ Plus Board	PIC32 MCUs	A 32-bit flexible platform for 24-bit audio record and playback, USB digital audio, MP3 decode and sample rate conversion. Made for iPod capability.	MP3 Audio Decode and Playback, Apple Made for iPod Library, USB Stack (Device and Host), Graphics Library, Sample Rate Conversion Library, Android Accessory Library
Recording & Playback	Audio Development Board for dsPIC33E MCUs (DM330016)	MFi Pictail Plus Board	dsPIC33E DSCs	A 16-bit digital signal controller based platform for 24-bit audio record and playback. DSP intensive processing capability for FFTs, equalizers, and audio decoders. Made for iPod capability.	Apple Made for iPod Library, USB Stack (Device and Host), Graphics Library, Sample Rate Conversion Library, Android Accessory Library
Recording & Playback	Explorer 16 Development Board (DM240001)	Speech Playback PICTail Plus Daughter Board (AC164125)	PIC24, dsPIC33, PIC32	Speech recording and playback using Adaptive Differential Pulse Code Modulation (ADPCM). Includes PICTail and PICTail Plus interface.	G711, G726A, Speex, Audio Library for PIC32, dsPIC DSC Speech and Audio Fast Forward (SAFF) Tool
Recording, Playback, Output Mixing (Karaoke)	PIC32 USB Digital Audio Accessory Development Board (DM320014)*	–	PIC32 MCUs	USB audio headset support, low-cost, 16/24-bit USB digital audio solution with flexible reference clocking feature, software processing capable (equalizer, AGC, software decoders).	USB Stack (Device and Host), Sample Rate Conversion Library, Android Accessory Library
Recording & Playback	Explorer 16 Development Board (DM240001)	Audio PICTail Plus Daughter Board (AC164129)	PIC24, dsPIC33, PIC32	Speech recording and playback using Adaptive Differential Pulse Code Modulation (ADPCM).	ADPCM, G711, G726A, Speex, Audio Library for PIC32, dsPIC DSC Speech and Audio Fast Forward (SAFF) Tool, dsPIC Automatic Gain Control Library
Recording & Playback	MPLAB® Starter Kit for dsPIC33 DSC (DM330022)	–	dsPIC33F DSC	Speech recording and playback using Adaptive Differential Pulse Code Modulation (ADPCM).	ADPCM, G711, G726A, Speex, dsPIC Automatic Gain Control Library

\*Check [www.Microchip.com](http://www.Microchip.com) for availability.



## Support

Microchip is committed to supporting its customers in developing products faster and more efficiently. We maintain a worldwide network of field applications engineers and technical support ready to provide product and system assistance. In addition, the following service areas are available at [www.microchip.com](http://www.microchip.com):

- **Support** link provides a way to get questions answered fast: <http://support.microchip.com>
- **Sample** link offers evaluation samples of any Microchip device: <http://sample.microchip.com>
- **Forum** link provides access to knowledge base and peer help: <http://forum.microchip.com>
- **Buy** link provides locations of Microchip Sales Channel Partners: [www.microchip.com/sales](http://www.microchip.com/sales)

## Sales Office Listing

### AMERICAS

#### Atlanta

Tel: 678-957-9614

#### Boston

Tel: 774-760-0087

#### Chicago

Tel: 630-285-0071

#### Cleveland

Tel: 216-447-0464

#### Dallas

Tel: 972-818-7423

#### Detroit

Tel: 248-538-2250

#### Indianapolis

Tel: 317-773-8323

#### Los Angeles

Tel: 949-462-9523

#### Santa Clara

Tel: 408-961-6444

#### Toronto

Mississauga, Ontario

Tel: 905-673-0699

### EUROPE

#### Austria - Wels

Tel: 43-7242-2244-39

#### Denmark - Copenhagen

Tel: 45-4450-2828

#### France - Paris

Tel: 33-1-69-53-63-20

#### Germany - Munich

Tel: 49-89-627-144-0

#### Italy - Milan

Tel: 39-0331-742611

#### Netherlands - Drunen

Tel: 31-416-690399

#### Spain - Madrid

Tel: 34-91-708-08-90

#### UK - Wokingham

Tel: 44-118-921-5869

## Training

If additional training interests you, then Microchip can help. We continue to expand our technical training options, offering a growing list of courses and in-depth curriculum locally, as well as significant online resources – whenever you want to use them.

- Technical Training Centers: [www.microchip.com/training](http://www.microchip.com/training)
- MASTERS Conferences: [www.microchip.com/masters](http://www.microchip.com/masters)
- Worldwide Seminars: [www.microchip.com/seminars](http://www.microchip.com/seminars)
- eLearning: [www.microchip.com/webseminars](http://www.microchip.com/webseminars)
- Resources from our Distribution and Third Party Partners [www.microchip.com/training](http://www.microchip.com/training)

### ASIA/PACIFIC

#### Australia - Sydney

Tel: 61-2-9868-6733

#### China - Beijing

Tel: 86-10-8569-7000

#### China - Chengdu

Tel: 86-28-8665-5511

#### China - Chongqing

Tel: 86-23-8980-9588

#### China - Hangzhou

Tel: 86-571-2819-3187

#### China - Hong Kong SAR

Tel: 852-2401-1200

#### China - Nanjing

Tel: 86-25-8473-2460

#### China - Qingdao

Tel: 86-532-8502-7355

#### China - Shanghai

Tel: 86-21-5407-5533

#### China - Shenyang

Tel: 86-24-2334-2829

#### China - Shenzhen

Tel: 86-755-8203-2660

#### China - Wuhan

Tel: 86-27-5980-5300

#### China - Xiamen

Tel: 86-592-2388138

#### China - Xian

Tel: 86-29-8833-7252

#### China - Zhuhai

Tel: 86-756-3210040

### ASIA/PACIFIC

#### India - Bangalore

Tel: 91-80-3090-4444

#### India - New Delhi

Tel: 91-11-4160-8631

#### India - Pune

Tel: 91-20-2566-1512

#### Japan - Osaka

Tel: 81-6-6152-7160

#### Japan - Yokohama

Tel: 81-45-471- 6166

#### Korea - Daegu

Tel: 82-53-744-4301

#### Korea - Seoul

Tel: 82-2-554-7200

#### Malaysia - Kuala Lumpur

Tel: 60-3-6201-9857

#### Malaysia - Penang

Tel: 60-4-227-8870

#### Philippines - Manila

Tel: 63-2-634-9065

#### Singapore

Tel: 65-6334-8870

#### Taiwan - Hsin Chu

Tel: 886-3-5778-366

#### Taiwan - Kaohsiung

Tel: 886-7-2137828

#### Taiwan - Taipei

Tel: 886-2-2500-6610

#### Thailand - Bangkok

Tel: 66-2-694-1351

11/29/11

Microcontrollers • Digital Signal Controllers • Analog • Memory • Wireless

Information subject to change. The Microchip name and logo, the Microchip logo, dsPIC, MPLAB and PIC are registered trademarks and PICDEM, PICtail and mTouch are trademarks of Microchip Technology Incorporated in the U.S.A. and other countries. © 2012 Energizer. Energizer and other marks are trademarks owned by Energizer. All other trademarks mentioned herein are property of their respective companies. © 2012, Microchip Technology Incorporated. All Rights Reserved. Printed in the U.S.A. 5/12 DS01214J



  
**MICROCHIP**  
[www.microchip.com](http://www.microchip.com)

Microchip Technology Inc.  
2355 W. Chandler Blvd.  
Chandler, AZ 85224-6199

# Mouser Electronics

Authorized Distributor

Click to View Pricing, Inventory, Delivery & Lifecycle Information:

[Microchip:](#)

[DM320014](#)