



Surface Mount 3000 Watt Transient Voltage Suppressor

Screening in
reference to
MIL-PRF-19500
available

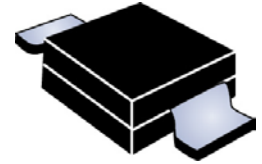
DESCRIPTION

The MSMLG(J)5.0A through MXLSMLG(J)170A series of high-reliability Transient Voltage Suppressors (TVSs) protect circuits from voltage spikes containing up to 3000 W (10/1000 μ s model pulse). The SMLG gull-wing design in the DO-215AB package allows for visible solder connections. The SMLJ J-bend design in the DO-214AB package allows for greater PC board mounting density. Selections include unidirectional and bidirectional as well as RoHS compliant versions. These are available with a variety of upscreening options for enhanced reliability. They protect against the secondary effects of lightning per IEC61000-4-5 and against voltage pulses from inductive switching environments and induced by RF radiation. Since their response time is virtually instantaneous, they can also be used in protection from ESD and EFT per IEC61000-4-2 and IEC61000-4-4.

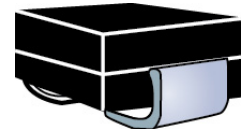
Important: For the latest information, visit our website <http://www.microsemi.com>.

FEATURES

- High reliability devices with fabrication and assembly lot traceability for all M prefix devices
- All devices are 100% surge tested
- 3σ lot norm screening performed on standby current (I_D) for all M prefix devices
- Available in both unidirectional and bidirectional versions
- Moisture classification is "Level 1" with no dry pack required per IPC/JEDEC J-STD-020B for all M prefix devices.
- Enhanced reliability screening options with M prefix are available in reference to MIL-PRF-19500. Refer to [High Reliability Up-Screened Plastic Products Portfolio](#) for more details on the screening options.
(See [part nomenclature](#) for all available options.)
- RoHS compliant versions available
- Axial-lead equivalent packages for thru-hole mounting are available as M5KP5.0A to M5KP110CA with 5000 W rating (contact Microsemi for other surface mount options).



**DO-215AB
Package**



**DO-214AB
Package**

APPLICATIONS / BENEFITS

- Suppresses transients up to 3000 watts (10/1000 us test pulse - see [Figure 2](#))
- Selections for 5.0 to 170 volts standoff voltages (V_{WM})
- Protection from switching transients and induced RF
- Protection from ESD, and EFT per IEC 61000-4-2 and IEC 61000-4-4
- Secondary lightning protection per IEC61000-4-5 with 42 ohms source impedance:
 - Class 1 & 2: SML 5.0A to SML 170A or CA
 - Class 3: SML 5.0A to SML 150A or CA
 - Class 4: SML 5.0A to SML 75A or CA
- Secondary lightning protection per IEC61000-4-5 with 12 ohms source impedance:
 - Class 1: SML 5.0A to SML 170A or CA
 - Class 2: SML 5.0A to SML 90A or CA
 - Class 3: SML 5.0A to SML 48A or CA
 - Class 4: SML 5.0A to SML 24A or CA
- Secondary lightning protection per IEC61000-4-5 with 2 ohms source impedance:
 - Class 2: SML 5.0A to SML 43A or CA
 - Class 3: SML 5.0A to SML 22A or CA
 - Class 4: SML 5.0A to SML 10A or CA

MSC – Lawrence

6 Lake Street,
Lawrence, MA 01841
Tel: 1-800-446-1158 or
(978) 620-2600
Fax: (978) 689-0803

MSC – Ireland

Gort Road Business Park,
Ennis, Co. Clare, Ireland
Tel: +353 (0) 65 6840044
Fax: +353 (0) 65 6822298

Website:

www.microsemi.com

MAXIMUM RATINGS

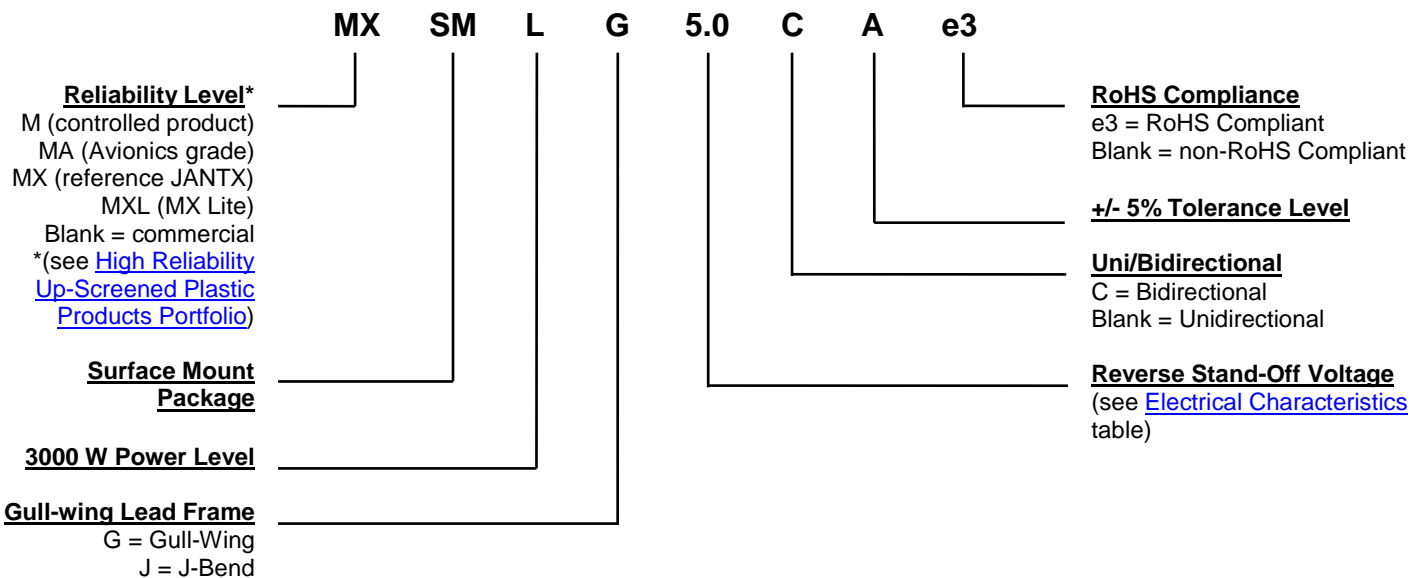
Parameters/Test Conditions	Symbol	Value	Unit	
Junction and Storage Temperature	T _J and T _{STG}	-65 to +150	°C	
Thermal Resistance Junction-to-Lead	R _{θJL}	17.5	°C/W	
Thermal Resistance Junction-to-Ambient ⁽¹⁾	R _{θJA}	77.5	°C/W	
Peak Pulse Power Dissipation @ 25 °C (at 10/1000 μs, see Figures 1, 2, and 3)	P _{PP}	3000	W	
Impulse Repetition Rate (duty factor)	df	0.01 or less	%	
t _{clamping} (0 volts to V _(BR) min.)	Unidirectional Bidirectional	t _{clamping}	<100 <5	ps ns
Rated Average Power Dissipation	T _L = +45 °C T _A = +25 °C	P _{M(AV)}	6 1.61 ⁽¹⁾	W
Maximum Forward Surge Current ⁽²⁾	I _{FSM}	200	A (pk)	
Solder Temperature @ 10 s	T _{SP}	260	°C	

- Notes:** 1. When mounted on FR4 PC board (1oz Cu) with recommended footprint (see [last page](#))
2. Peak impulse of 8.3 ms half-sine wave at 25 °C (unidirectional only)

MECHANICAL and PACKAGING

- CASE: Void-free transfer molded thermosetting epoxy body meeting UL94V-0
- TERMINALS: Tin-lead or RoHS compliant annealed matte-tin plating. Solderable to MIL-STD-750, method 2026.
- MARKING: Part number marked on package
- POLARITY: Cathode indicated by band. No cathode band on bi-directional devices
- TAPE & REEL option: Standard per EIA-481-B with 16 mm tape (add "TR" suffix to part number). Consult factory for quantities.
- WEIGHT: Approximately 0.25 grams
- See [Package Dimensions](#) on last page.

PART NOMENCLATURE



SYMBOLS & DEFINITIONS

Symbol	Definition
$I_{(BR)}$	Breakdown Current: The current used for measuring breakdown voltage $V_{(BR)}$.
I_D	Standby Current: The current at the rated standoff voltage (V_{WM}).
I_F	Forward Current: The forward current dc value, no alternating component.
I_O	Average Rectified Output Current: The output current averaged over a full cycle with a 50 Hz or 60 Hz sine-wave input and a 180 degree conduction angle.
I_{PP}	Peak Impulse Current: The peak current during the impulse.
P_{PP}	Peak Pulse Power: The peak power dissipation resulting from the peak impulse current I_{PP} .
V_C	Clamping Voltage: Maximum clamping voltage at specified I_{PP} (Peak Pulse Current) at the specified pulse conditions.
$V_{(BR)}$	Minimum Breakdown Voltage: The minimum voltage the device will exhibit at a specified current.
V_{WM}	Working Peak Voltage: The maximum peak voltage that can be applied over the operating temperature range. This is also referred to as standoff voltage.

ELECTRICAL CHARACTERISTICS @ 25 °C unless otherwise stated

PART NUMBER		REVERSE STAND-OFF VOLTAGE V_{WM} Volts	BREAKDOWN VOLTAGE $V_{(BR)}$ @ $I_{(BR)}$ Volts		MAXIMUM CLAMPING VOLTAGE @ I_{PP} Volts	PEAK PULSE CURRENT (See Fig. 2) I_{PP} Amps	MAXIMUM STANDBY CURRENT @ V_{WM} I_D μA
Gull-Wing	J-Bend		MIN.	MAX.			
SMLG5.0A	SMLJ5.0A	5.0	6.40 – 7.00	10	9.2	326.0	1000
SMLG6.0A	SMLJ6.0A	6.0	6.67 – 7.37	10	10.3	291.3	1000
SMLG6.5A	SMLJ6.5A	6.5	7.22 – 7.98	10	11.2	267.9	500
SMLG7.0A	SMLJ7.0A	7.0	7.78 – 8.60	10	12.0	250.0	200
SMLG7.5A	SMLJ7.5A	7.5	8.33 – 9.21	1	12.9	232.6	100
SMLG8.0A	SMLJ8.0A	8.0	8.89 – 9.83	1	13.6	220.6	50
SMLG8.5A	SMLJ8.5A	8.5	9.44 – 10.4	1	14.4	208.4	25
SMLG9.0A	SMLJ9.0A	9.0	10.0 – 11.1	1	15.4	194.8	10
SMLG10A	SMLJ10A	10	11.1 – 12.3	1	17.0	176.4	5
SMLG11A	SMLJ11A	11	12.2 – 13.5	1	18.2	164.8	5
SMLG12A	SMLJ12A	12	13.3 – 14.7	1	19.9	150.6	5
SMLG13A	SMLJ13A	13	14.4 – 15.9	1	21.5	139.4	5
SMLG14A	SMLJ14A	14	15.6 – 17.2	1	23.2	129.4	2
SMLG15A	SMLJ15A	15	16.7 – 18.5	1	24.4	123.0	2
SMLG16A	SMLJ16A	16	17.8 – 19.7	1	26.0	115.4	2
SMLG17A	SMLJ17A	17	18.9 – 20.9	1	27.6	106.6	2
SMLG18A	SMLJ18A	18	20.0 – 22.1	1	29.2	102.8	2
SMLG20A	SMLJ20A	20	22.2 – 24.5	1	32.4	92.6	2
SMLG22A	SMLJ22A	22	24.4 – 26.9	1	35.5	84.4	2
SMLG24A	SMLJ24A	24	26.7 – 29.5	1	38.9	77.2	2
SMLG26A	SMLJ26A	26	28.9 – 31.9	1	42.1	71.2	2
SMLG28A	SMLJ28A	28	31.1 – 34.4	1	45.4	66.0	2
SMLG30A	SMLJ30A	30	33.3 – 36.8	1	48.4	62.0	2
SMLG33A	SMLJ33A	33	36.7 – 40.6	1	53.3	56.2	2
SMLG36A	SMLJ36A	36	40.0 – 44.2	1	58.1	51.6	2
SMLG40A	SMLJ40A	40	44.4 – 49.1	1	64.5	46.4	2
SMLG43A	SMLJ43A	43	47.8 – 52.8	1	69.4	43.2	2
SMLG45A	SMLJ45A	45	50.0 – 55.3	1	72.7	41.2	2
SMLG48A	SMLJ48A	48	53.3 – 58.9	1	77.4	38.8	2
SMLG51A	SMLJ51A	51	56.7 – 62.7	1	82.4	36.4	2
SMLG54A	SMLJ54A	54	60.0 – 66.3	1	87.1	34.4	2
SMLG58A	SMLJ58A	58	64.4 – 71.2	1	93.6	32.0	2
SMLG60A	SMLJ60A	60	66.7 – 73.7	1	96.8	31.0	2
SMLG64A	SMLJ64A	64	71.1 – 78.6	1	103.0	29.2	2
SMLG70A	SMLJ70A	70	77.8 – 86.0	1	113	26.6	2
SMLG75A	SMLJ75A	75	83.3 – 92.1	1	121	24.8	2

Continued.

ELECTRICAL CHARACTERISTICS @ 25 °C unless otherwise stated (continued)

MICROSEMI PART NUMBER		REVERSE STAND-OFF VOLTAGE V_{WM}	BREAKDOWN VOLTAGE $V_{(BR)}$ @ $I_{(BR)}$ Volts		MAXIMUM CLAMPING VOLTAGE @ I_{PP}	PEAK PULSE CURRENT (See Fig. 2) I_{PP}	MAXIMUM STANDBY CURRENT @ V_{WM} I_D μA
Gull-Wing	J-Bend		Volts	MIN. MAX.			
SMLG78A	SMLJ78A	78	86.7 – 95.8	1	126	22.8	2
SMLG85A	SMLJ85A	85	94.4 – 104.0	1	137	20.8	2
SMLG90A	SMLJ90A	90	100 – 111	1	146	20.6	2
SMLG100A	SMLJ100A	100	111 – 123	1	162	18.6	2
SMLG110A	SMLJ110A	110	122 – 135	1	177	16.8	2
SMLG120A	SMLJ120A	120	133 – 147	1	193	15.6	2
SMLG130A	SMLJ130A	130	144 – 159	1	209	14.4	2
SMLG150A	SMLJ150A	150	167 – 185	1	243	12.4	2
SMLG160A	SMLJ160A	160	178 – 197	1	259	11.6	2
SMLG170A	SMLJ170A	170	189 – 209	1	275	11.0	2

NOTE 1: Bidirectional capacitance is half that shown in figure 4 at zero volts.

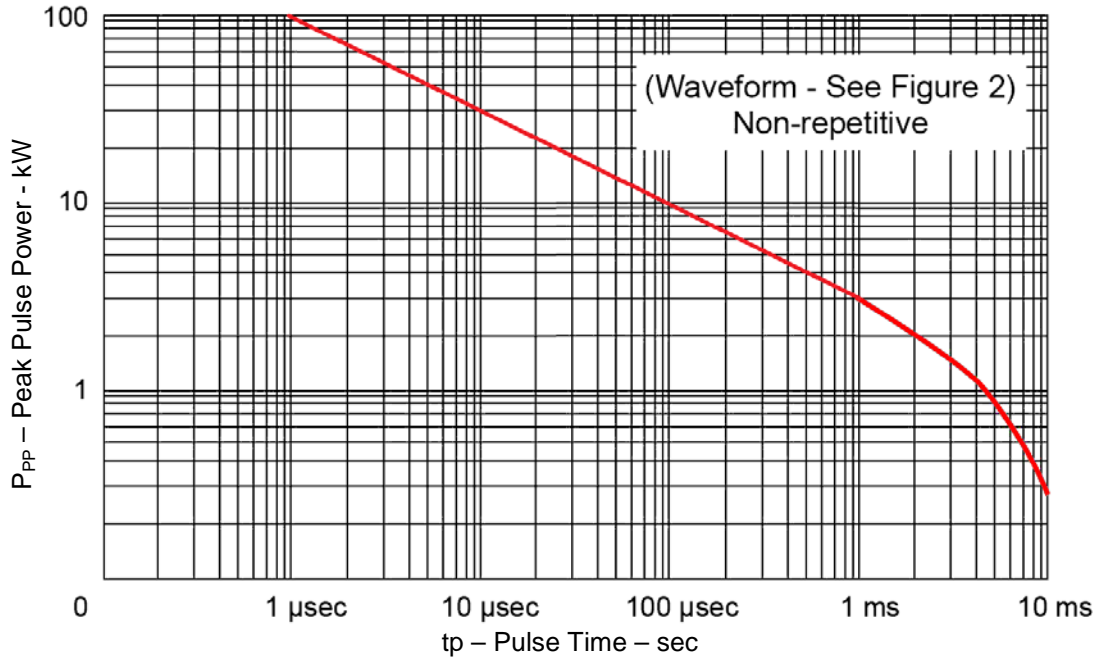
GRAPHS


FIGURE 1
Peak Pulse Power vs. Pulse Time

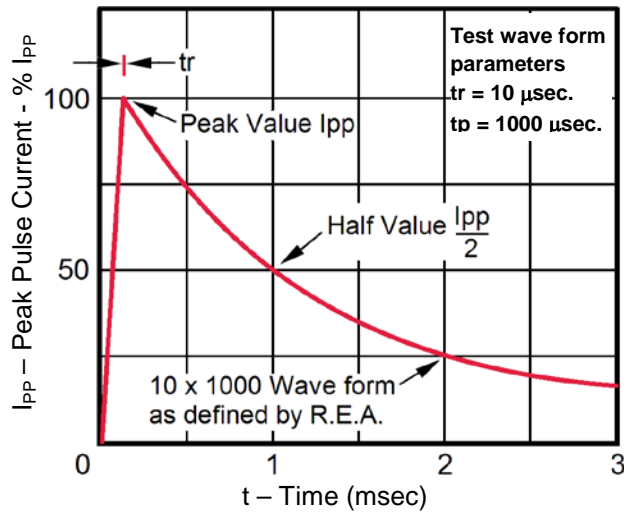


FIGURE 2
Pulse Waveform

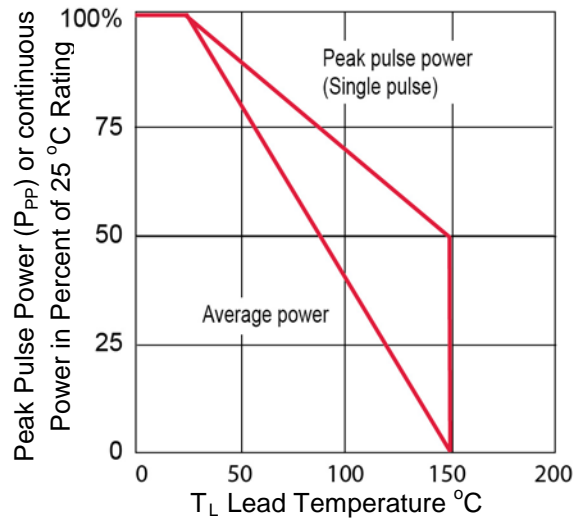
GRAPHS (continued)


FIGURE 3
Derating Curve

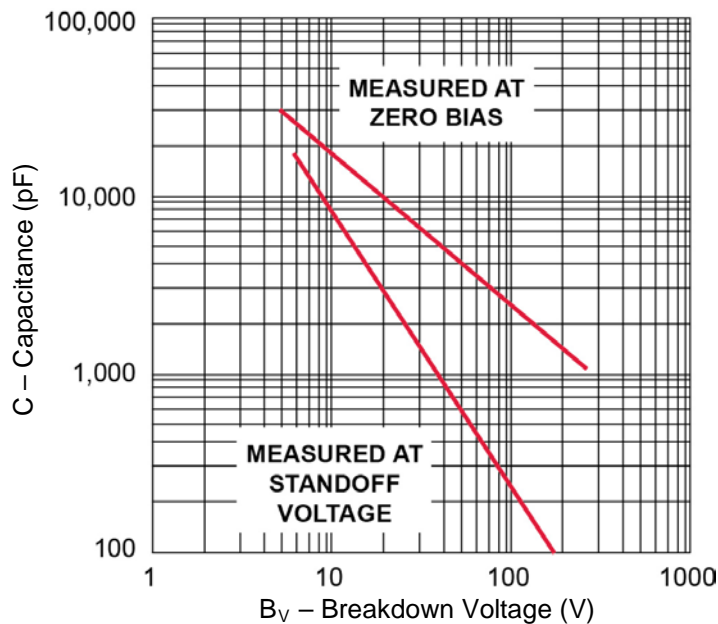
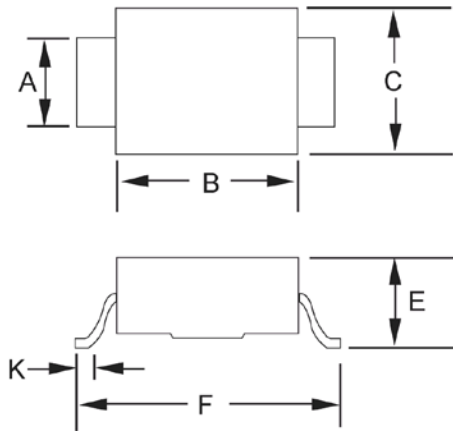
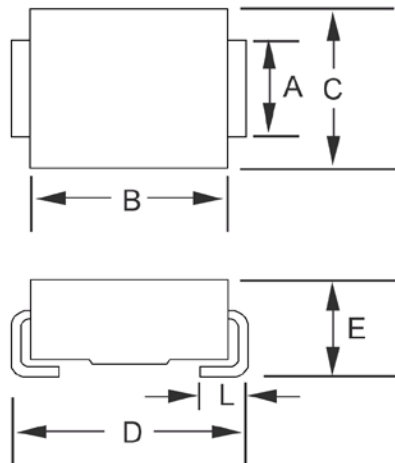


FIGURE 4
Typical Capacitance vs.
Breakdown Voltage (unidirectional configuration)
NOTE: Bidirectional capacitance is half that shown at zero volts.

PACKAGE DIMENSIONS

SMLG (DO-215AB)

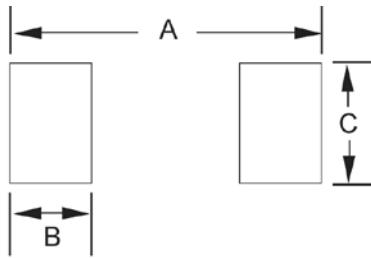
Ltr	Dimensions			
	Inch		Millimeters	
	Min	Max	Min	Max
A	0.115	0.121	2.92	3.07
B	0.260	0.280	6.60	7.11
C	0.220	0.245	5.59	6.22
E	0.077	0.110	1.95	2.80
F	0.380	0.400	9.65	10.16
K	0.025	0.040	0.635	1.016

NOTES: Dimension "E" exceeds the JEDEC outline as shown.
Typical Standoff Height: 0.004" – 0.008" (0.1 mm – 0.2 mm).


SMLJ (DO-214AB)

Ltr	Dimensions			
	Inch		Millimeters	
	Min	Max	Min	Max
A	0.115	0.121	2.92	3.07
B	0.260	0.280	6.60	7.11
C	0.220	0.245	5.59	6.22
D	0.305	0.320	7.75	8.13
E	0.077	0.110	1.95	2.80
L	0.030	0.060	0.760	1.52

NOTES: Dimension "E" exceeds the JEDEC outline in height as shown.
Typical Standoff Height: 0.004" – 0.008" (0.1 mm – 0.2 mm).

PAD LAYOUT


SMLG (DO-215AB)		
Ltr	Inch	Millimeters
A	0.510	12.95
B	0.110	2.79
C	0.150	3.81

SMLJ (DO-214AB)		
Ltr	Inch	Millimeters
A	0.390	9.90
B	0.110	2.79
C	0.150	3.81