

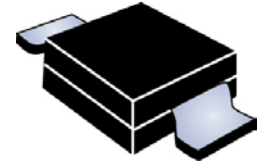


2 kW Surface Mount Transient Voltage Suppressor

Screening in
reference to
MIL-PRF-19500
available

DESCRIPTION

The MSMBG(J)2K3.0 – MSMBG(J)2K5.0 series of surface mount 2.0 kilowatt transient voltage suppressors provide a selection of standoff voltages (V_{WM}) from 3.0 to 5.0 volts. These high-reliability controlled devices feature unidirectional construction. The SMBG Gull-wing design in the DO-215AA package is ideal for visible solder connections. The SMBJ J-bend design in the DO-214AA package is ideal for greater PC board mounting density. It is also available as RoHS compliant.

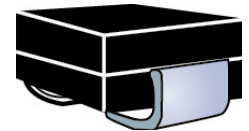


**DO-215AA
(SMBG) Package**

Important: For the latest information, visit our website <http://www.microsemi.com>.

FEATURES

- High reliability upscreened devices with wafer fabrication and assembly lot traceability.
- All devices 100% surge tested.
- Suppresses transients up to 2 kW @ 8/20 μ s.
- Other screening in reference to MIL-PRF-19500 is also available. Refer to [MicroNote 129](#) for more details on the screening options.
(See [part nomenclature](#) for all options.)
- Moisture classification is Level 1 with no dry pack required per IPC/JEDEC J-STD-020B.
- 3 σ lot norm screening performed on standby current I_D .
- RoHS compliant versions available.



**DO-214AA
(SMBJ) Package**

NOTE: All SMB series are equivalent to prior SMS package identifications.

APPLICATIONS / BENEFITS

- Voltage and reverse standby (leakage) current lowest available.
- Protects sensitive components such as IC's, CMOS, Bipolar, BiCMOS, ECL, DTL, T2L, etc.
- Protection from switching transients & induced RF.
- Compliant to IEC61000-4-2 and IEC61000-4-4 for ESD and EFT protection respectively.
- Secondary lightning protection per IEC61000-4-5 with 42 ohms source impedance for class 1.

MAXIMUM RATINGS @ 25 °C unless otherwise stated

Parameters/Test Conditions	Symbol	Value	Unit
Junction and Storage Temperature	T_J and T_{STG}	-65 to +150	°C
Peak Pulse Power Dissipation ⁽¹⁾	P_{PP}	2000 300	W
Off-State Power Dissipation	P_D	5 1.38 ⁽²⁾	W
$T_{clamping}$ (0 volts to $V_{(BR)}$ min)		<100	ps
Forward Voltage @ 30 A ⁽³⁾	V_F	1.2	V
Solder Temperature @ 10 s	T_{SP}	260	°C

- Notes:**
1. With impulse repetition rate (duty factor) of 0.01 maximum (also [Figure 1 and 4](#)).
 2. When mounted on FR4 PC board (1oz Cu) with recommended footprint (see [last page](#)).
 3. Peak impulse of 8.3 ms half-sine wave.

MSC – Lawrence

6 Lake Street,
Lawrence, MA 01841
Tel: 1-800-446-1158 or
(978) 620-2600
Fax: (978) 689-0803

MSC – Ireland

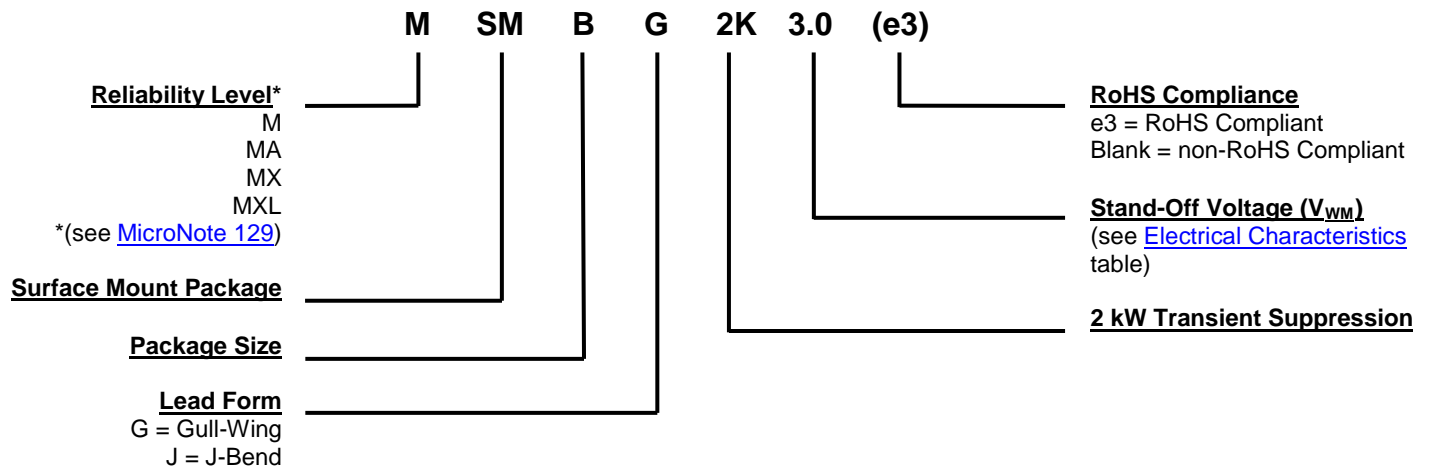
Gort Road Business Park,
Ennis, Co. Clare, Ireland
Tel: +353 (0) 65 6840044
Fax: +353 (0) 65 6822298

Website:

www.microsemi.com

MECHANICAL and PACKAGING

- CASE: Void-free transfer molded thermosetting epoxy body meeting UL94V-0 requirements.
- TERMINALS: Tin-lead or RoHS compliant annealed matte-tin plating readily solderable per MIL-STD-750, method 2026.
- MARKING: Part number.
- POLARITY: Cathode end banded.
- TAPE & REEL option: Standard per EIA-296 (add "TR" suffix to part number). Consult factory for quantities.
- WEIGHT: 0.1 grams (approximate).
- See [package dimensions](#) on last page.

PART NOMENCLATURE

SYMBOLS & DEFINITIONS

Symbol	Definition
V_{WM}	Working Peak (Standoff) Voltage - The maximum peak voltage that can be applied over the operating temperature range. This is also referred to as standoff voltage.
P_{PP}	Peak Pulse Power - Rated random recurring peak impulse power dissipation.
$V_{(BR)}$	Breakdown Voltage - The minimum voltage the device will exhibit at a specified current.
I_D	Standby Current - The current at the rated standoff voltage (V_{WM}).
I_{PP}	Peak Pulse Current - The peak current during the impulse.
V_C	Clamping Voltage - Clamping voltage at I_{PP} (Peak Pulse Current) at the specified pulse conditions (typically shown as maximum value).
$I_{(BR)}$	Breakdown Current – The current used for measuring breakdown voltage $V_{(BR)}$.

ELECTRICAL CHARACTERISTICS @ 25 °C

PART NUMBER		BREAKDOWN VOLTAGE Minimum	BREAKDOWN CURRENT	RATED STANDOFF VOLTAGE	MAX STANDBY CURRENT	MAX CLAMPING VOLTAGE	PEAK PULSE CURRENT	TEMPERATURE COEFFICIENT of $V_{(BR)}$
		$V_{(BR)}$	$I_{(BR)}$	V_{WM}	$I_D @ V_{WM}$	$V_C @ I_{PP}$	I_{PP}	$\alpha_{V(BR)}$
Gull-Wing	J-Bend	V	mA	V	μA	V	A	% / °C
MSMBG2K3.0	MSMBJ2K3.0	4.3	50	3.0	1500	5.4	10	+0/ -0.05
MSMBG2K3.3	MSMBJ2K3.3	4.6	50	3.3	700	5.8	10	± 0.025
MSMBG2K4.0	MSMBJ2K4.0	5.0	50	4.0	400	6.3	10	± 0.030
MSMBG2K4.5	MSMBJ2K4.5	5.4	50	4.5	50	6.6	10	± 0.040
MSMBG2K5.0	MSMBJ2K5.0	5.9	50	5.0	5	7.6	10	+0.050

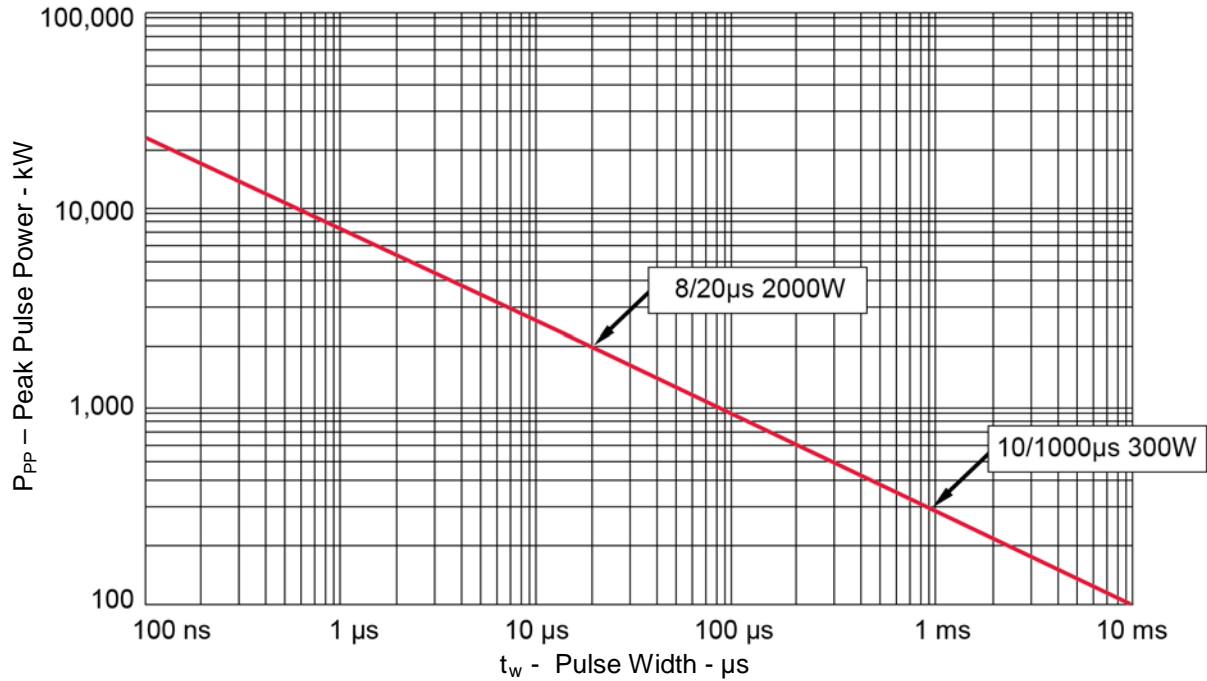
GRAPHS


FIGURE 1
Peak Pulse Power vs Pulse Time

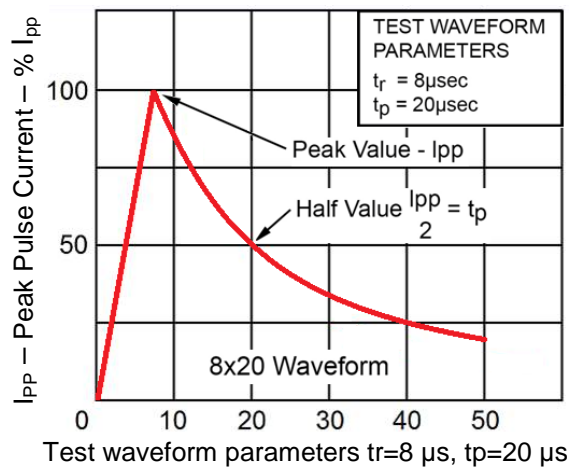
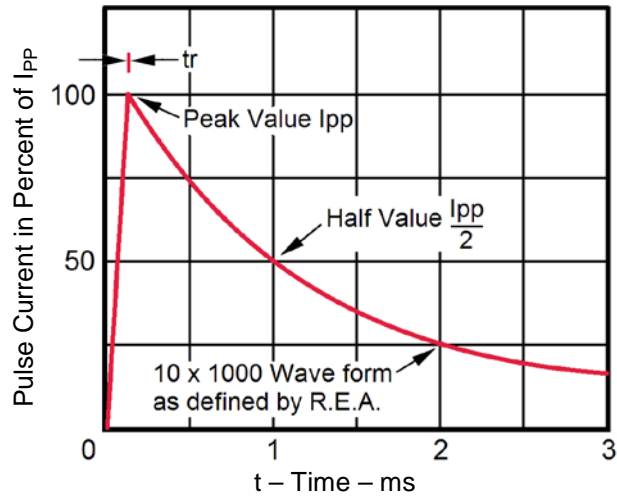


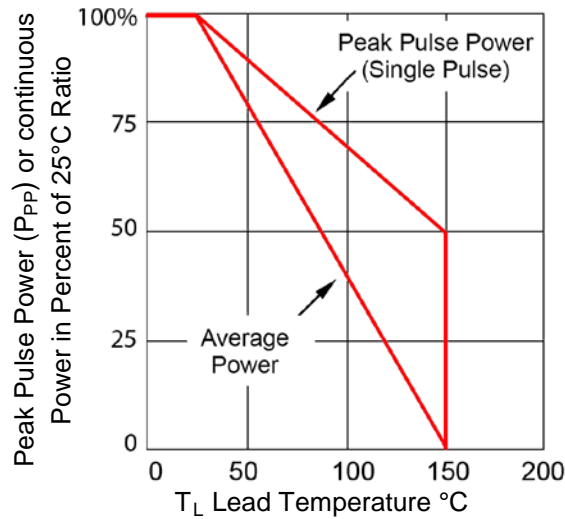
FIGURE 2
Pulse Waveform for 8/20 μs Exponential Surge

GRAPHS (continued)


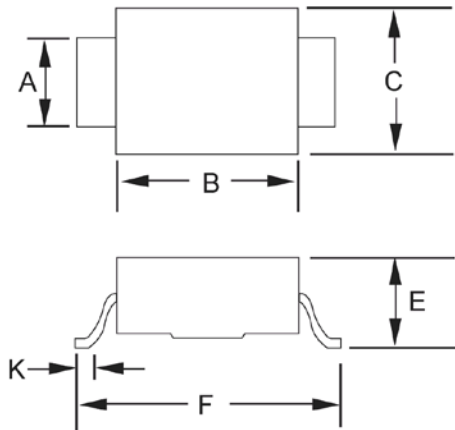
Test waveform parameters: $t_r=10\ \mu s$, $t_p=1000\ \mu s$

FIGURE 3

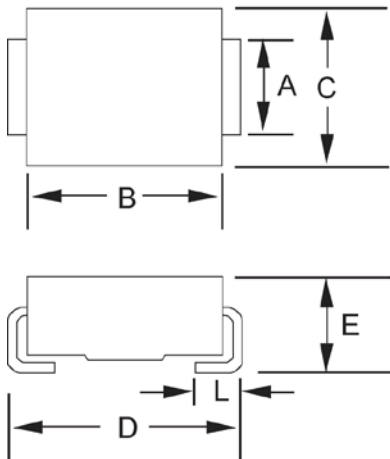
Pulse Waveform for 10/1000 Exponential Surge


FIGURE 4

Derating Curve

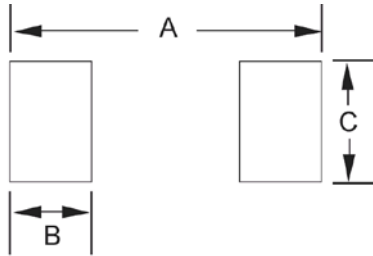
PACKAGE DIMENSIONS

SMBG (DO-215AA)

Ltr	Dimensions			
	Inch		Millimeters	
	Min	Max	Min	Max
A	0.077	0.083	1.96	2.10
B	0.160	0.180	4.06	4.57
C	0.130	0.155	3.30	3.94
E	0.077	0.104	1.95	2.65
F	0.235	0.255	5.97	6.48
K	0.015	0.030	0.381	0.762


SMBJ (DO-214AA)

Ltr	Dimensions			
	Inch		Millimeters	
	Min	Max	Min	Max
A	0.077	0.083	1.96	2.10
B	0.160	0.180	4.06	4.57
C	0.130	0.155	3.30	3.94
D	0.205	0.220	5.21	5.59
E	0.077	0.104	1.95	2.65
L	0.030	0.060	0.760	1.52

See pad layout on next page.

PAD LAYOUT


SMBG (DO-215AA)		
Ltr	Inch	Millimeters
A	0.320	8.13
B	0.085	2.16
C	0.110	2.79

SMBJ (DO-214AA)		
Ltr	Inch	Millimeters
A	0.260	6.60
B	0.085	2.16
C	0.110	2.79