

## Asymmetrical - Bridge NPT IGBT Power Module

$V_{CES} = 1200V$   
 $I_C = 50A @ T_c = 80^\circ C$

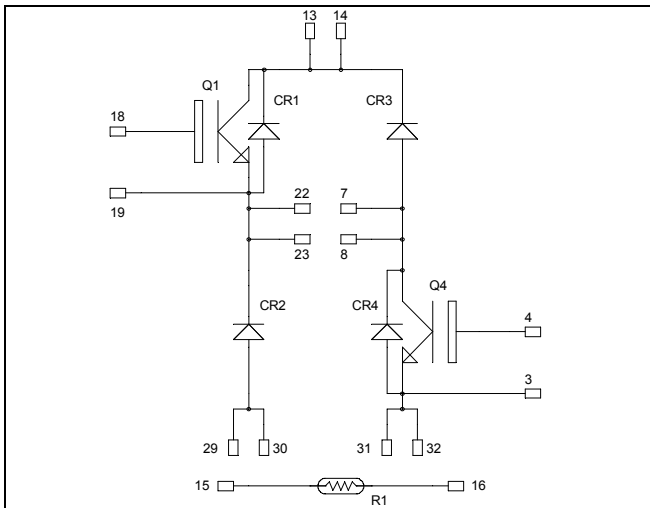

### Application

- AC and DC motor control
- Switched Mode Power Supplies

### Features

- Non Punch Through (NPT) Fast IGBT
  - Low voltage drop
  - Low tail current
  - Switching frequency up to 50 kHz
  - Soft recovery parallel diodes
  - Low diode VF
  - Low leakage current
  - RBSOA and SCSOA rated
  - Symmetrical design
- Kelvin emitter for easy drive
- Very low stray inductance
- High level of integration
- Internal thermistor for temperature monitoring

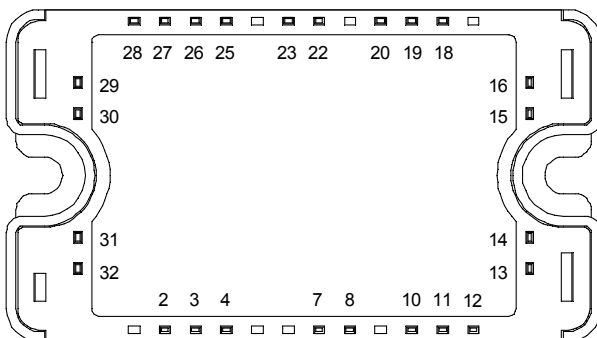

### Benefits

- Outstanding performance at high frequency operation
- Direct mounting to heatsink (isolated package)
- Low junction to case thermal resistance
- Solderable terminals both for power and signal for easy PCB mounting
- Low profile
- Easy paralleling due to positive TC of VCEsat
- RoHS compliant

All multiple inputs and outputs must be shorted together  
 Example: 13/14 ; 29/30 ; 22/23 ...

### Absolute maximum ratings

| Symbol    | Parameter                             | Max ratings         | Unit         |
|-----------|---------------------------------------|---------------------|--------------|
| $V_{CES}$ | Collector - Emitter Breakdown Voltage | 1200                | V            |
| $I_C$     | Continuous Collector Current          | $T_c = 25^\circ C$  | 70           |
|           |                                       | $T_c = 80^\circ C$  | 50           |
| $I_{CM}$  | Pulsed Collector Current              | $T_c = 25^\circ C$  | 150          |
| $V_{GE}$  | Gate - Emitter Voltage                | $\pm 20$            | V            |
| $P_D$     | Maximum Power Dissipation             | $T_c = 25^\circ C$  | 312          |
| RBSOA     | Reverse Bias Safe Operating Area      | $T_j = 150^\circ C$ | 100A @ 1200V |

**CAUTION:** These Devices are sensitive to Electrostatic Discharge. Proper Handling Procedures Should Be Followed. See application note APT0502 on [www.microsemi.com](http://www.microsemi.com)

All ratings @  $T_j = 25^\circ\text{C}$  unless otherwise specified

**Electrical Characteristics**

| Symbol        | Characteristic                       | Test Conditions                                 | Min                       | Typ | Max | Unit          |
|---------------|--------------------------------------|---|---------------------------|-----|-----|---------------|
| $I_{CES}$     | Zero Gate Voltage Collector Current  | $V_{GE} = 0\text{V}$<br>$V_{CE} = 1200\text{V}$ | $T_j = 25^\circ\text{C}$  |     | 250 | $\mu\text{A}$ |
|               |                                      |   | $T_j = 125^\circ\text{C}$ |     | 500 |               |
| $V_{CE(sat)}$ | Collector Emitter saturation Voltage | $V_{GE} = 15\text{V}$<br>$I_C = 50\text{A}$     | $T_j = 25^\circ\text{C}$  | 3.2 | 3.7 | V             |
|               |                                      |   | $T_j = 125^\circ\text{C}$ | 4.0 |     |               |
| $V_{GE(th)}$  | Gate Threshold Voltage               | $V_{GE} = V_{CE}, I_C = 1\text{mA}$             | 4.5                       |     | 6.5 | V             |
| $I_{GES}$     | Gate – Emitter Leakage Current       | $V_{GE} = 20\text{V}, V_{CE} = 0\text{V}$       |                           |     | 100 | nA            |

**Dynamic Characteristics**

| Symbol       | Characteristic               | Test Conditions  | Min                       | Typ  | Max  | Unit |
|--------------|------------------------------|--|---------------------------|------|------|------|
| $C_{ies}$    | Input Capacitance            | $V_{GE} = 0\text{V}$<br>$V_{CE} = 25\text{V}$<br>$f = 1\text{MHz}$   |                           | 3450 |      | pF   |
| $C_{oes}$    | Output Capacitance           |  |                           | 330  |      |      |
| $C_{res}$    | Reverse Transfer Capacitance |  |                           | 220  |      |      |
| $Q_g$        | Total gate Charge            | $V_{GS} = 15\text{V}$<br>$V_{Bus} = 600\text{V}$<br>$I_C = 50\text{A}$   |                           | 330  |      | nC   |
| $Q_{ge}$     | Gate – Emitter Charge        |  |                           | 35   |      |      |
| $Q_{gc}$     | Gate – Collector Charge      |  |                           | 200  |      |      |
| $T_{d(on)}$  | Turn-on Delay Time           | Inductive Switching ( $25^\circ\text{C}$ )<br>$V_{GE} = 15\text{V}$<br>$V_{Bus} = 600\text{V}$<br>$I_C = 50\text{A}$<br>$R_G = 5\ \Omega$      |                           | 35   |      | ns   |
| $T_r$        | Rise Time                    |  |                           | 65   |      |      |
| $T_{d(off)}$ | Turn-off Delay Time          |  |                           | 320  |      |      |
| $T_f$        | Fall Time                    |  |                           | 30   |      |      |
| $T_{d(on)}$  | Turn-on Delay Time           | Inductive Switching ( $125^\circ\text{C}$ )<br>$V_{GE} = \pm 15\text{V}$<br>$V_{Bus} = 600\text{V}$<br>$I_C = 50\text{A}$<br>$R_G = 5\ \Omega$ |                           | 35   |      | ns   |
| $T_r$        | Rise Time                    |  |                           | 65   |      |      |
| $T_{d(off)}$ | Turn-off Delay Time          |  |                           | 360  |      |      |
| $T_f$        | Fall Time                    |  |                           | 40   |      |      |
| $E_{on}$     | Turn-on Switching Energy     | $V_{GE} = \pm 15\text{V}$<br>$V_{Bus} = 600\text{V}$<br>$I_C = 50\text{A}$<br>$R_G = 5\ \Omega$  | $T_j = 125^\circ\text{C}$ |      | 6.9  | mJ   |
| $E_{off}$    | Turn-off Switching Energy    |  |                           |      | 3.05 |      |
| $I_{sc}$     | Short Circuit data           | $V_{GE} \leq 15\text{V}; V_{Bus} = 900\text{V}$<br>$t_p \leq 10\ \mu\text{s}; T_j = 125^\circ\text{C}$   |                           | 300  |      | A    |

**Diode ratings and characteristics (CR2 & CR3)**

| Symbol    | Characteristic                          | Test Conditions  | Min                       | Typ  | Max | Unit          |
|-----------|---|--|---------------------------|------|-----|---------------|
| $V_{RRM}$ | Maximum Peak Repetitive Reverse Voltage |  | 1200                      |      |     | V             |
| $I_{RM}$  | Maximum Reverse Leakage Current         | $V_R = 1200\text{V}$   | $T_j = 25^\circ\text{C}$  |      | 100 | $\mu\text{A}$ |
|           |   |  | $T_j = 125^\circ\text{C}$ |      | 500 |               |
| $I_F$     | DC Forward Current                      | $T_C = 80^\circ\text{C}$   |                           | 60   |     | A             |
| $V_F$     | Diode Forward Voltage                   | $I_F = 60\text{A}$   |                           | 2.5  | 3   | V             |
|           |   | $I_F = 120\text{A}$  |                           | 3    |     |               |
|           |   | $I_F = 60\text{A}$   | $T_j = 125^\circ\text{C}$ | 1.8  |     |               |
| $t_{rr}$  | Reverse Recovery Time                   | $I_F = 60\text{A}$<br>$V_R = 800\text{V}$<br>$di/dt = 200\text{A}/\mu\text{s}$ | $T_j = 25^\circ\text{C}$  | 265  |     | ns            |
|           |   |  | $T_j = 125^\circ\text{C}$ | 350  |     |               |
| $Q_{rr}$  | Reverse Recovery Charge                 | $I_F = 60\text{A}$<br>$V_R = 800\text{V}$<br>$di/dt = 200\text{A}/\mu\text{s}$ | $T_j = 25^\circ\text{C}$  | 560  |     | nC            |
|           |   |  | $T_j = 125^\circ\text{C}$ | 2890 |     |               |

CR1 &amp; CR4 are IGBT protection diodes only

## Thermal and package characteristics

| Symbol            | Characteristic   | Min         | Typ | Max | Unit |     |
|-------------------|--|-------------|-----|-----|------|-----|
| R <sub>thJC</sub> | Junction to Case Thermal Resistance                          | IGBT        |     | 0.4 | °C/W |     |
|                   |  | Diode       |     | 0.9 |      |     |
| V <sub>ISOL</sub> | RMS Isolation Voltage, any terminal to case t=1 min, 50/60Hz | 4000        |     |     | V    |     |
| T <sub>J</sub>    | Operating junction temperature range                         | -40         |     | 150 | °C   |     |
| T <sub>STG</sub>  | Storage Temperature Range                                    | -40         |     | 125 |      |     |
| T <sub>C</sub>    | Operating Case Temperature                                   | -40         |     | 100 |      |     |
| Torque            | Mounting torque  | To heatsink | M4  | 2   | 3    | N.m |
| Wt                | Package Weight   |             |     |     | 110  | g   |

## Temperature sensor NTC (see application note APT0406 on www.microsemi.com for more information).

| Symbol                            | Characteristic             | Min                   | Typ  | Max | Unit |
|-----------------------------------|----------------------------|-----------------------|------|-----|------|
| R <sub>25</sub>                   | Resistance @ 25°C          |                       | 50   |     | kΩ   |
| ΔR <sub>25</sub> /R <sub>25</sub> |                            |                       | 5    |     | %    |
| B <sub>25/85</sub>                | T <sub>25</sub> = 298.15 K |                       | 3952 |     | K    |
| ΔB/B                              |                            | T <sub>C</sub> =100°C | 4    |     | %    |

$$R_T = \frac{R_{25}}{\exp\left[B_{25/85}\left(\frac{1}{T_{25}} - \frac{1}{T}\right)\right]}$$

T: Thermistor temperature  
 R<sub>T</sub>: Thermistor value at T

## SP3 Package outline (dimensions in mm)

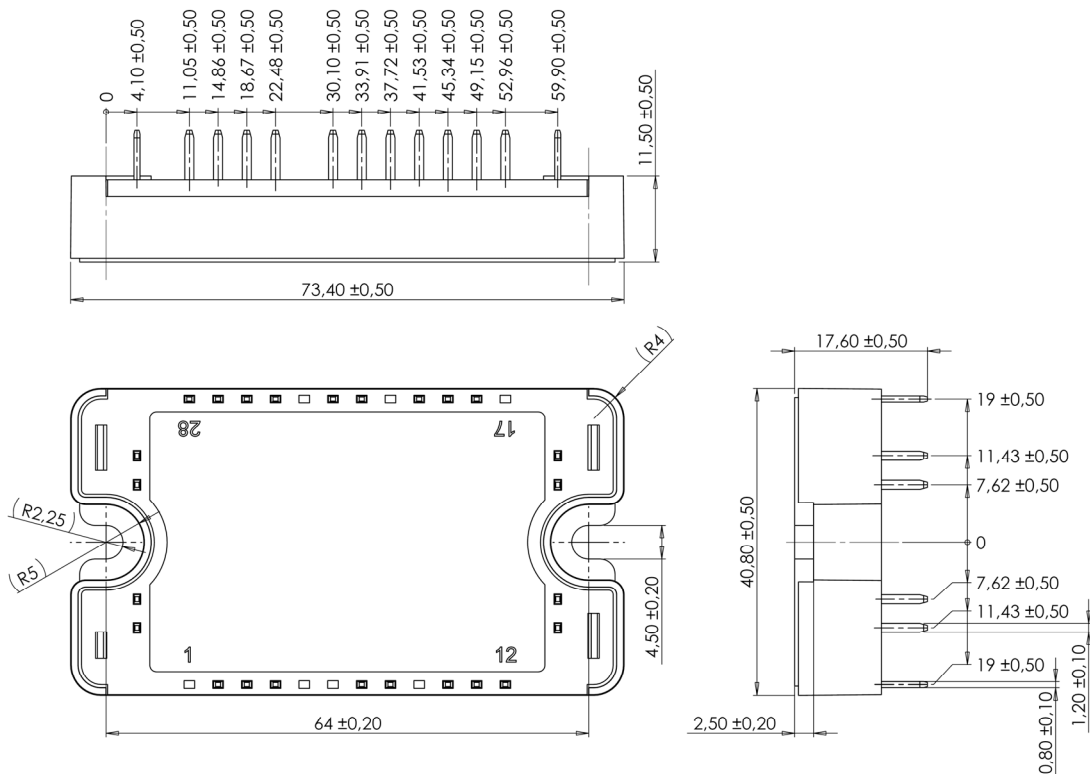

See application note 1901 - Mounting Instructions for SP3 Power Modules on [www.microsemi.com](http://www.microsemi.com)

## Typical IGBT Performance Curve

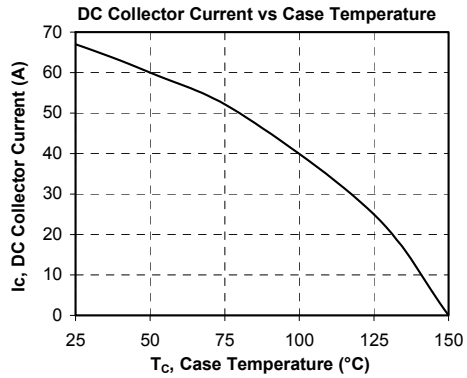
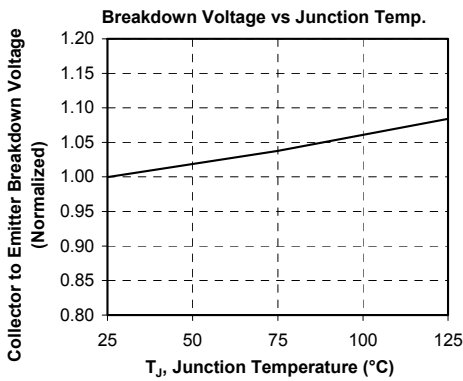
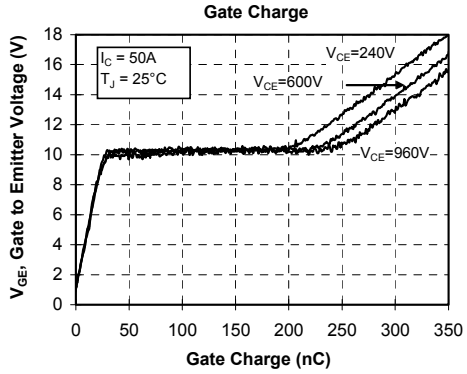
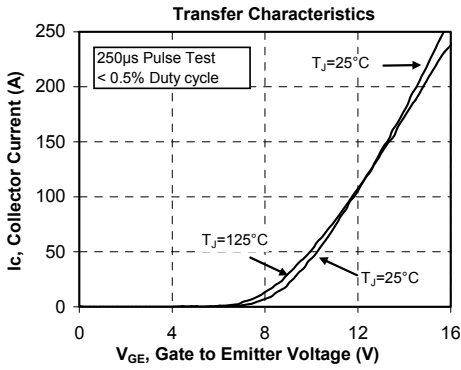
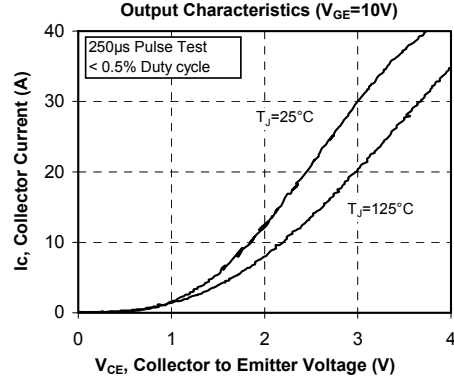
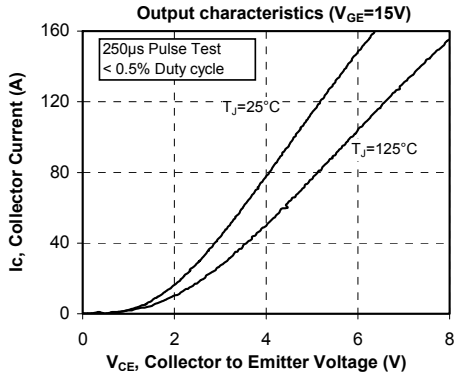

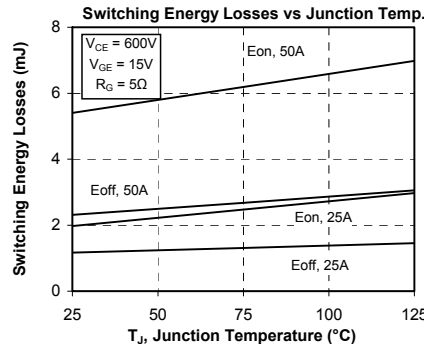
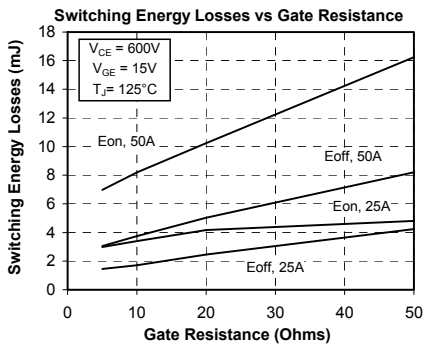
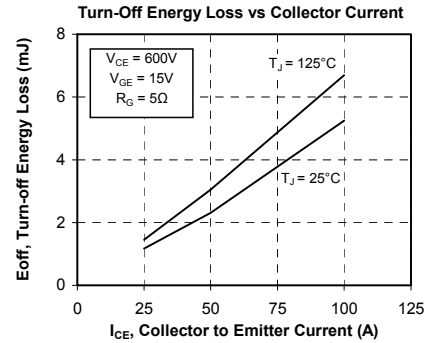
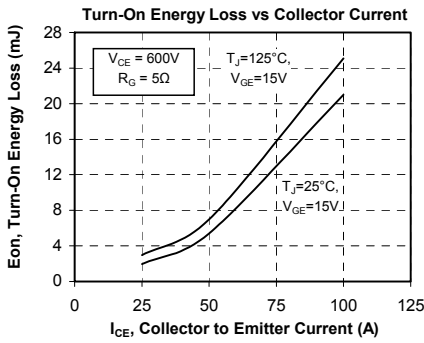
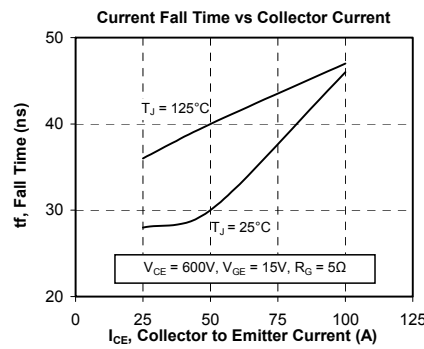
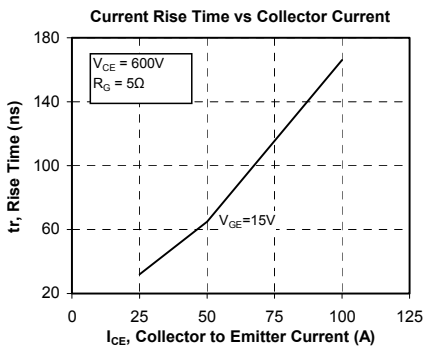
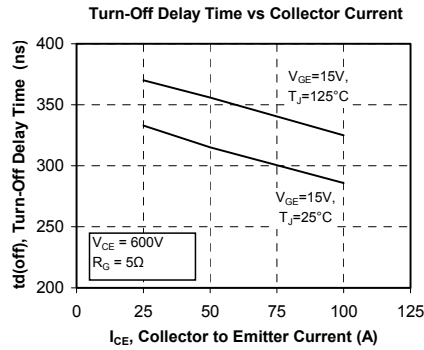
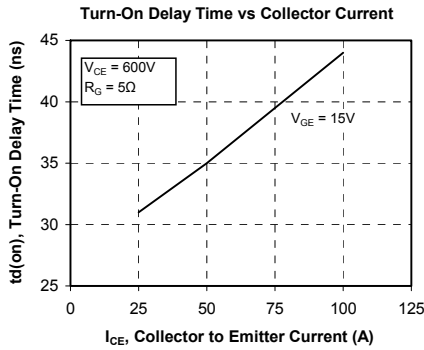

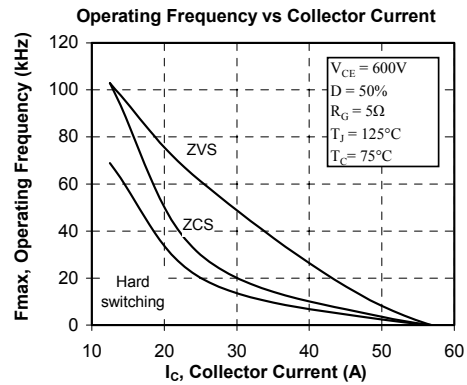
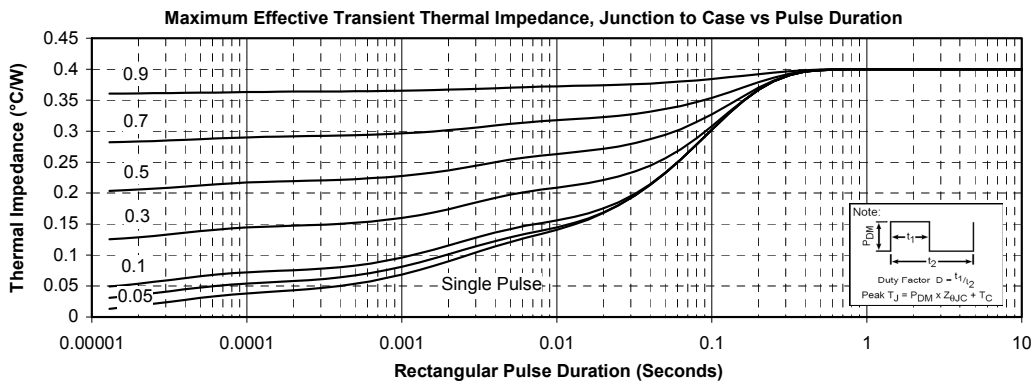
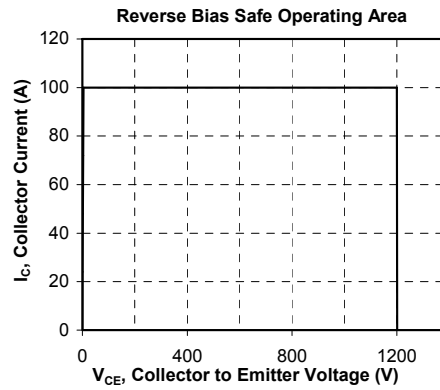
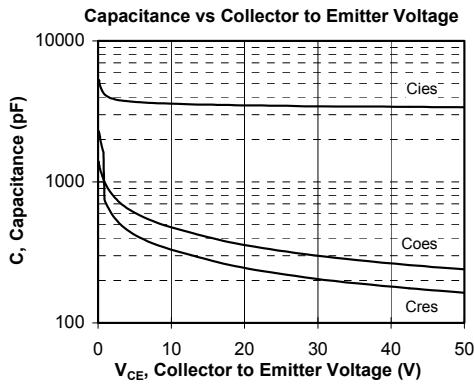

## Typical diode Performance Curve

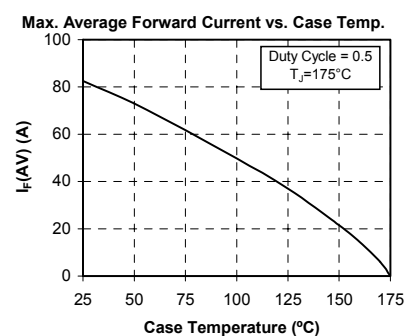
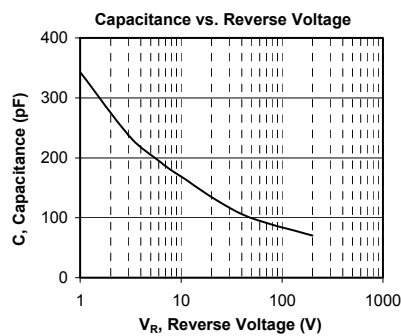
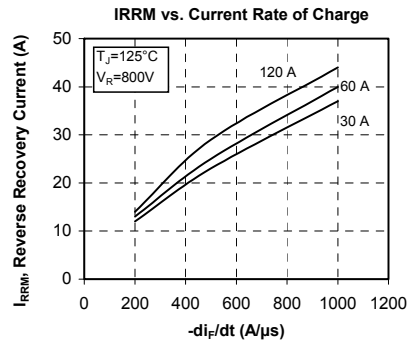
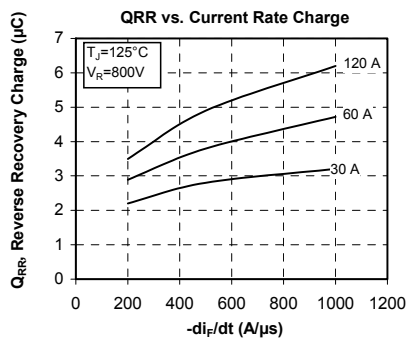
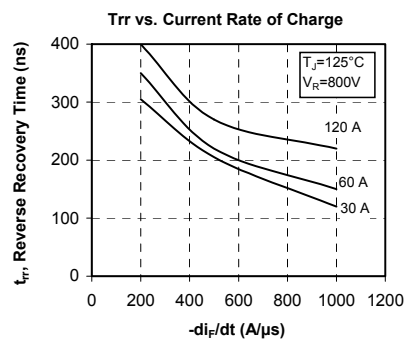
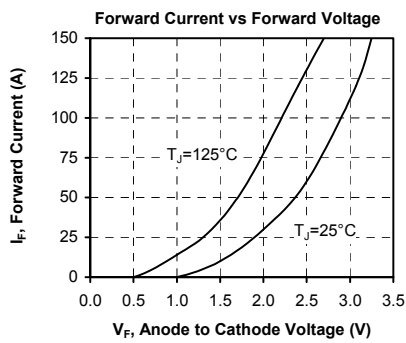
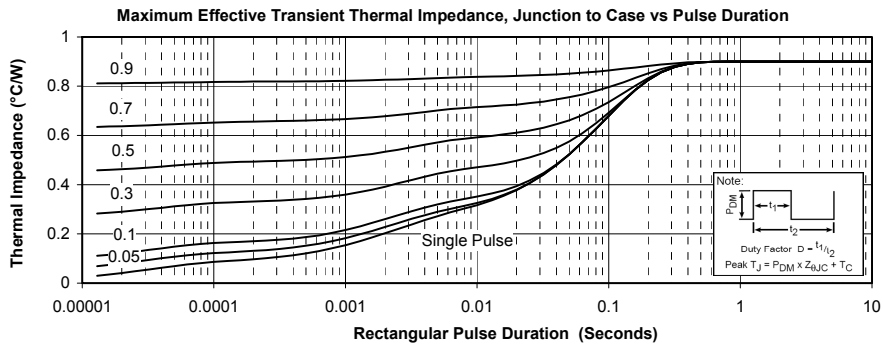

## DISCLAIMER

The information contained in the document (unless it is publicly available on the Web without access restrictions) is PROPRIETARY AND CONFIDENTIAL information of Microsemi and cannot be copied, published, uploaded, posted, transmitted, distributed or disclosed or used without the express duly signed written consent of Microsemi. If the recipient of this document has entered into a disclosure agreement with Microsemi, then the terms of such Agreement will also apply. This document and the information contained herein may not be modified, by any person other than authorized personnel of Microsemi. No license under any patent, copyright, trade secret or other intellectual property right is granted to or conferred upon you by disclosure or delivery of the information, either expressly, by implication, inducement, estoppels or otherwise. Any license under such intellectual property rights must be approved by Microsemi in writing signed by an officer of Microsemi.

Microsemi reserves the right to change the configuration, functionality and performance of its products at anytime without any notice. This product has been subject to limited testing and should not be used in conjunction with life-support or other mission-critical equipment or applications. Microsemi assumes no liability whatsoever, and Microsemi disclaims any express or implied warranty, relating to sale and/or use of Microsemi products including liability or warranties relating to fitness for a particular purpose, merchantability, or infringement of any patent, copyright or other intellectual property right. Any performance specifications believed to be reliable but are not verified and customer or user must conduct and complete all performance and other testing of this product as well as any user or customers final application. User or customer shall not rely on any data and performance specifications or parameters provided by Microsemi. It is the customer's and user's responsibility to independently determine suitability of any Microsemi product and to test and verify the same. The information contained herein is provided "AS IS, WHERE IS" and with all faults, and the entire risk associated with such information is entirely with the User. Microsemi specifically disclaims any liability of any kind including for consequential, incidental and punitive damages as well as lost profit. The product is subject to other terms and conditions which can be located on the web at <http://www.microsemi.com/legal/tnc.asp>

### Life Support Application

Seller's Products are not designed, intended, or authorized for use as components in systems intended for space, aviation, surgical implant into the body, in other applications intended to support or sustain life, or for any other application in which the failure of the Seller's Product could create a situation where personal injury, death or property damage or loss may occur (collectively "Life Support Applications").

Buyer agrees not to use Products in any Life Support Applications and to the extent it does it shall conduct extensive testing of the Product in such applications and further agrees to indemnify and hold Seller, and its officers, employees, subsidiaries, affiliates, agents, sales representatives and distributors harmless against all claims, costs, damages and expenses, and attorneys' fees and costs arising, directly or indirectly, out of any claims of personal injury, death, damage or otherwise associated with the use of the goods in Life Support Applications, even if such claim includes allegations that Seller was negligent regarding the design or manufacture of the goods.

Buyer must notify Seller in writing before using Seller's Products in Life Support Applications. Seller will study with Buyer alternative solutions to meet Buyer application specification based on Sellers sales conditions applicable for the new proposed specific part.