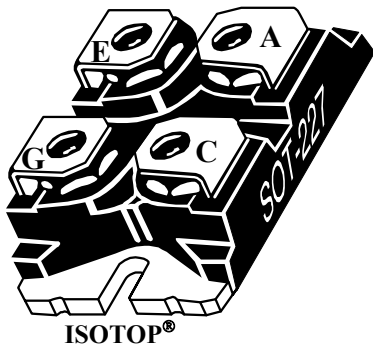
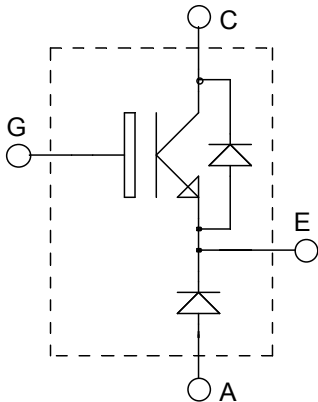

**ISOTOP<sup>®</sup> Buck chopper  
NPT IGBT**
 $V_{CES} = 600V$   
 $I_C = 60A @ T_c = 95^{\circ}C$ 

**Application**

- AC and DC motor control
- Switched Mode Power Supplies

**Features**

- Non Punch Through (NPT) THUNDERBOLT IGBT
  - Low voltage drop
  - Low tail current
  - Switching frequency up to 100 kHz
  - Soft recovery parallel diodes
  - Low diode VF
  - Low leakage current
  - RBSOA and SCSOA rated
- ISOTOP<sup>®</sup> Package (SOT-227)
- Very low stray inductance
- High level of integration

**Benefits**

- Outstanding performance at high frequency operation
- Stable temperature behavior
- Very rugged
- Direct mounting to heatsink (isolated package)
- Low junction to case thermal resistance
- Easy paralleling due to positive  $T_c$  of  $V_{CESat}$
- RoHS Compliant

**Absolute maximum ratings**

Symbol	Parameter	Max ratings	Unit
$V_{CES}$	Collector - Emitter Breakdown Voltage	600	V
$I_{C1}$	Continuous Collector Current	$T_c = 25^{\circ}C$	A
$I_{C2}$		$T_c = 95^{\circ}C$	
$I_{CM}$	Pulsed Collector Current	$T_c = 25^{\circ}C$	360
$V_{GE}$	Gate - Emitter Voltage	$\pm 20$	V
$P_D$	Maximum Power Dissipation	$T_c = 25^{\circ}C$	378
$I_{LM}$	RBSOA clamped Inductive load Current $R_G=11\Omega$	$T_c = 25^{\circ}C$	360
$I_{FAV}$	Maximum Average Forward Current	Duty cycle=0.5 $T_c = 80^{\circ}C$	30
$I_{FRMS}$	RMS Forward Current (Square wave, 50% duty)		39

**CAUTION:** These Devices are sensitive to Electrostatic Discharge. Proper Handling Procedures Should Be Followed.

All ratings @  $T_j = 25^\circ\text{C}$  unless otherwise specified

**Electrical Characteristics**

Symbol	Characteristic	Test Conditions	Min	Typ	Max	Unit
$BV_{CES}$	Collector - Emitter Breakdown Voltage	$V_{GE} = 0V, I_C = 0.5mA$	600			V
$I_{CES}$	Zero Gate Voltage Collector Current	$V_{GE} = 0V$ $V_{CE} = 600V$			80 2000	$\mu A$
$V_{CE(on)}$	Collector Emitter on Voltage	$V_{GE} = 15V$ $I_C = 60A$		2.0	2.5	V
					2.8	
$V_{GE(th)}$	Gate Threshold Voltage	$V_{GE} = V_{CE}, I_C = 500\mu A$	3	4	5	V
$I_{GES}$	Gate - Emitter Leakage Current	$V_{GE} = \pm 20V, V_{CE} = 0V$			$\pm 100$	nA

**Dynamic Characteristics**

Symbol	Characteristic	Test Conditions	Min	Typ	Max	Unit
$C_{ies}$	Input Capacitance	$V_{GE} = 0V$ $V_{CE} = 25V$ $f = 1MHz$		3125	3590	pF
$C_{oes}$	Output Capacitance			310	450	
$C_{res}$	Reverse Transfer Capacitance			180	310	
$Q_g$	Total gate Charge	$V_{GS} = 15V$ $V_{Bus} = 300V$ $I_C = 60A$		257	410	nC
$Q_{ge}$	Gate - Emitter Charge			19	30	
$Q_{gc}$	Gate - Collector Charge			120	180	
$T_{d(on)}$	Turn-on Delay Time	Resistive Switching ( $25^\circ\text{C}$ ) $V_{GE} = 15V$ $V_{Bus} = 300V$ $I_C = 60A$ $R_G = 5\Omega$		20	40	ns
$T_r$	Rise Time			95	190	
$T_{d(off)}$	Turn-off Delay Time			315	470	
$T_f$	Fall Time			245	490	
$T_{d(on)}$	Turn-on Delay Time	Inductive Switching ( $25^\circ\text{C}$ ) $V_{GE} = 15V$ $V_{Bus} = 400V$ $I_C = 60A$ $R_G = 5\Omega$		26	50	ns
$T_r$	Rise Time			63	125	
$T_{d(off)}$	Turn-off Delay Time			395	590	
$T_f$	Fall Time			68	140	
$E_{ts}$	Total switching Losses			3.4	7	mJ
$T_{d(on)}$	Turn-on Delay Time	Inductive Switching ( $150^\circ\text{C}$ ) $V_{GE} = 15V$ $V_{Bus} = 400V$ $I_C = 60A$ $R_G = 5\Omega$		25	50	ns
$T_r$	Rise Time			59	120	
$T_{d(off)}$	Turn-off Delay Time			430	650	
$T_f$	Fall Time			65	130	
$E_{on}$	Turn-on Switching Energy			1.6	3.2	mJ
$E_{off}$	Turn-off Switching Energy			2.4	4.8	
$E_{ts}$	Total switching Losses			4.0	8.0	

**Chopper code ratings and characteristics**

<i>Symbol</i>	<i>Characteristic</i>	<i>Test Conditions</i>		<i>Min</i>	<i>Typ</i>	<i>Max</i>	<i>Unit</i>
V <sub>F</sub>	Diode Forward Voltage	I <sub>F</sub> = 30A			1.6	1.8	V
		I <sub>F</sub> = 60A			1.9		
		I <sub>F</sub> = 30A	T <sub>j</sub> = 125°C		1.4		
I <sub>RM</sub>	Maximum Reverse Leakage Current	V <sub>R</sub> = 600V	T <sub>j</sub> = 25°C			250	μA
		V <sub>R</sub> = 600V	T <sub>j</sub> = 125°C			500	
C <sub>T</sub>	Junction Capacitance	V <sub>R</sub> = 200V			44		pF
t <sub>rr</sub>	Reverse Recovery Time	I <sub>F</sub> = 1A, V <sub>R</sub> = 30V di/dt = 100A/μs	T <sub>j</sub> = 25°C		23		ns
	Reverse Recovery Time		T <sub>j</sub> = 25°C		85		
			T <sub>j</sub> = 125°C		160		
I <sub>RRM</sub>	Maximum Reverse Recovery Current	I <sub>F</sub> = 30A V <sub>R</sub> = 400V di/dt = 200A/μs	T <sub>j</sub> = 25°C		4		A
			T <sub>j</sub> = 125°C		8		
			T <sub>j</sub> = 25°C		130		
Q <sub>rr</sub>	Reverse Recovery Charge		T <sub>j</sub> = 25°C		700		nC
			T <sub>j</sub> = 125°C				
t <sub>rr</sub>	Reverse Recovery Time	I <sub>F</sub> = 30A	T <sub>j</sub> = 125°C		70		ns
Q <sub>rr</sub>	Reverse Recovery Charge	V <sub>R</sub> = 400V			1300		nC
I <sub>RRM</sub>	Maximum Reverse Recovery Current	di/dt = 1000A/μs			30		A

**Thermal and package characteristics**

<i>Symbol</i>	<i>Characteristic</i>	<i>Min</i>	<i>Typ</i>	<i>Max</i>	<i>Unit</i>
R <sub>thJC</sub>	Junction to Case	IGBT		0.33	°C/W
		Diode		1.21	
R <sub>thJA</sub>	Junction to Ambient (IGBT & Diode)			20	
V <sub>ISOL</sub>	RMS Isolation Voltage, any terminal to case t = 1 min, 50/60Hz	2500			V
T <sub>J</sub> , T <sub>STG</sub>	Storage Temperature Range	-55		150	°C
T <sub>L</sub>	Max Lead Temp for Soldering: 0.063" from case for 10 sec			300	
Torque	Mounting torque (Mounting = 8-32 or 4mm Machine and terminals = 4mm Machine)			1.5	N.m
Wt	Package Weight		29.2		g

## Typical IGBT Performance Curve

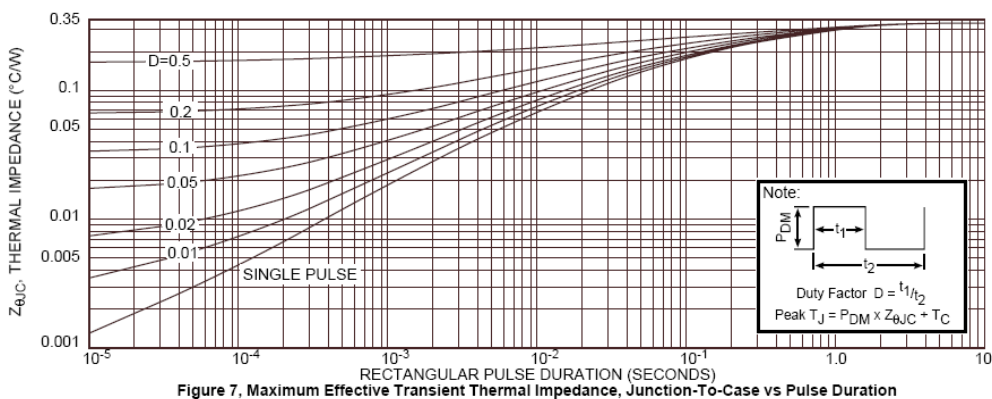
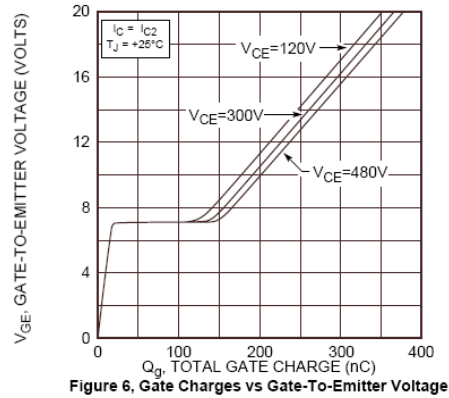
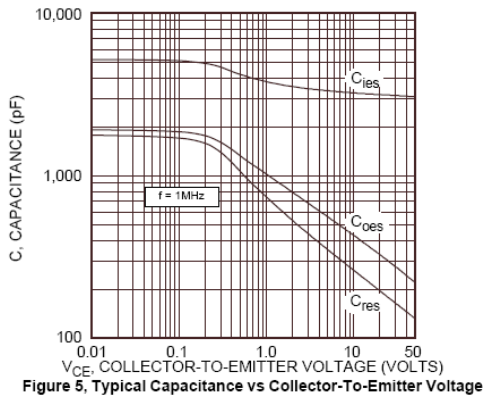
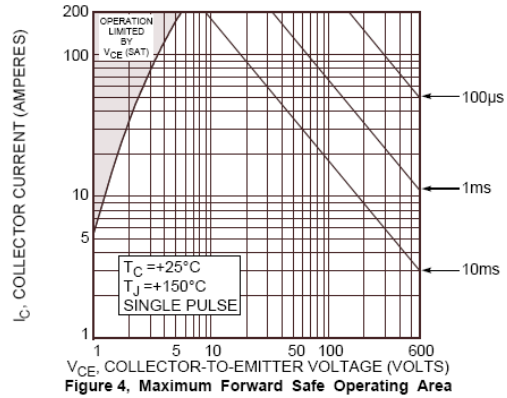
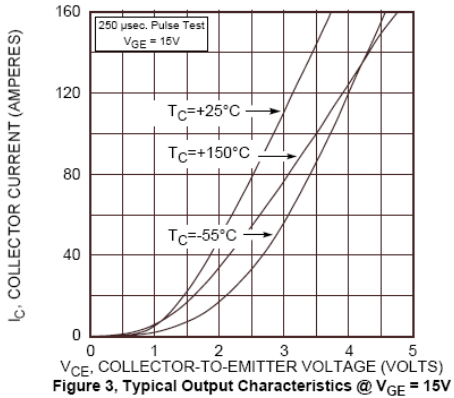
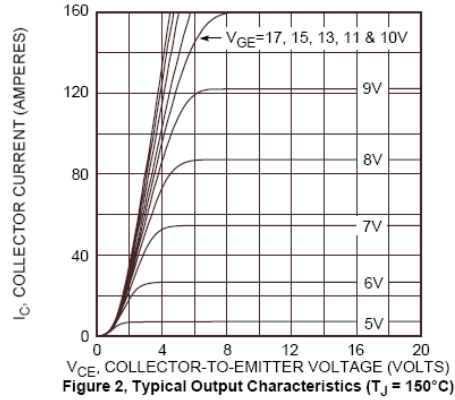
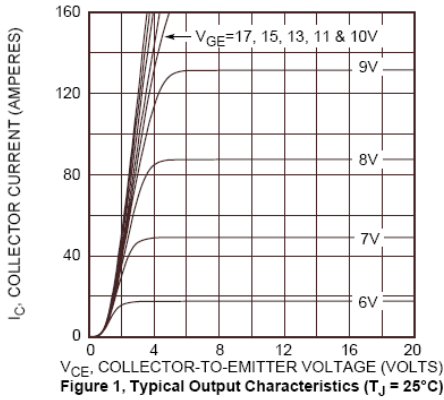

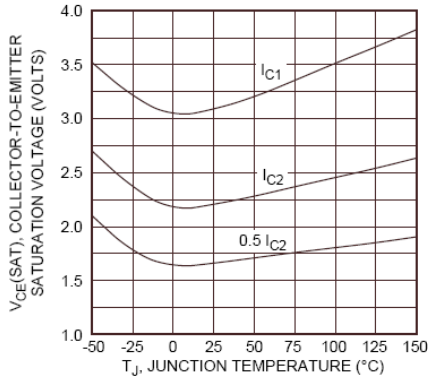

Figure 8, Typical  $V_{CE(SAT)}$  Voltage vs Junction Temperature

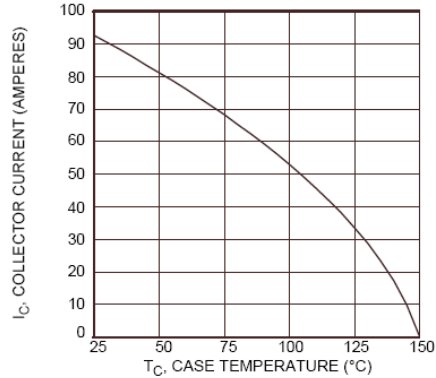

Figure 9, Maximum Collector Current vs Case Temperature

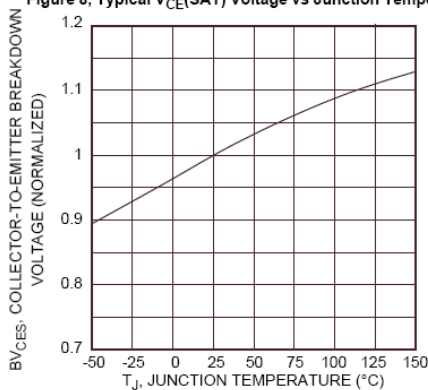

Figure 10, Breakdown Voltage vs Junction Temperature

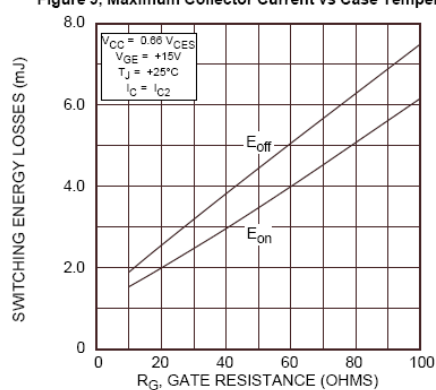

Figure 11, Typical Switching Energy Losses vs Gate Resistance

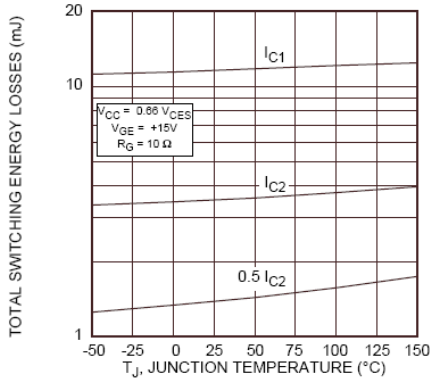

Figure 12, Typical Switching Energy Losses vs. Junction Temperature

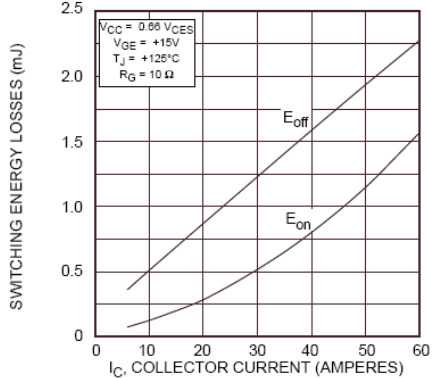

Figure 13, Typical Switching Energy Losses vs Collector Current

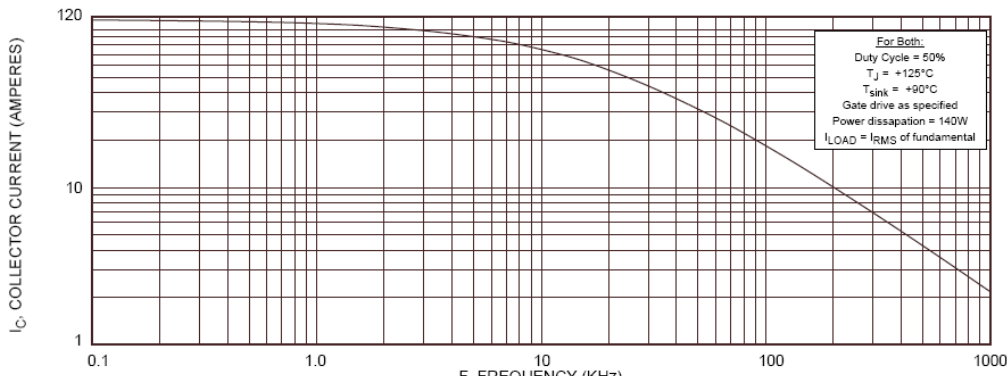

Figure 14, Typical Load Current vs Frequency

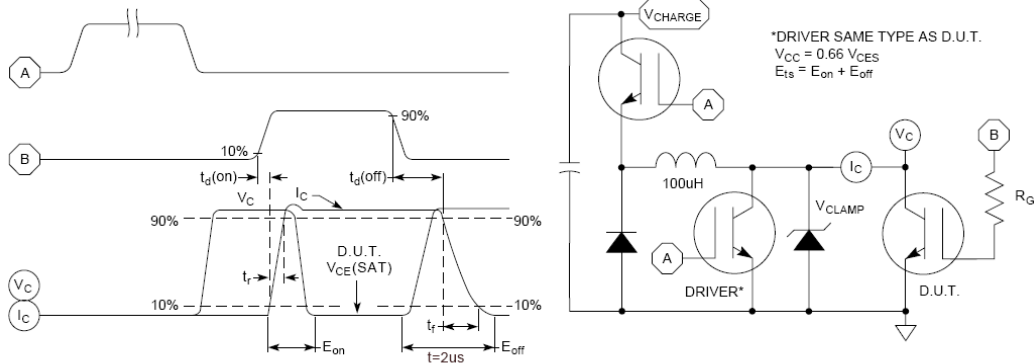

Figure 15, Switching Loss Test Circuit and Waveforms

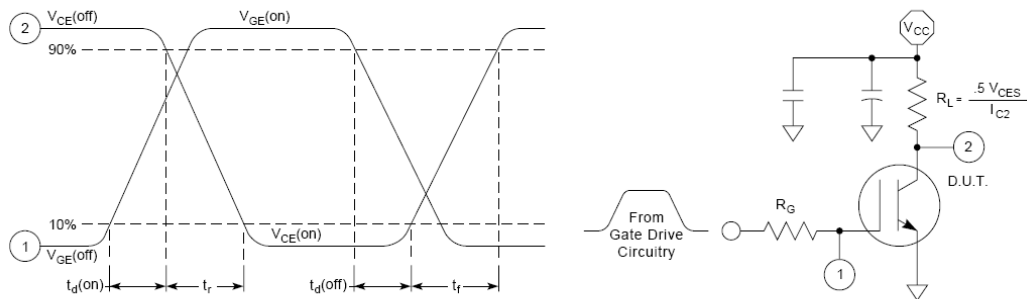

Figure 16, Resistive Switching Time Test Circuit and Waveforms

**Typical Diode Performance Curve**

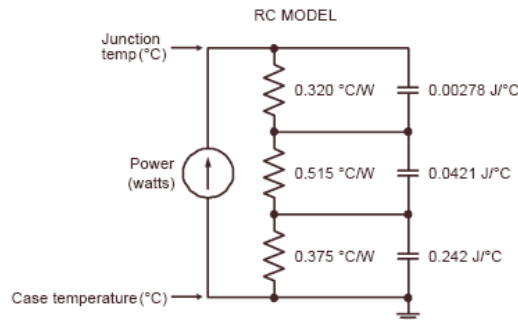
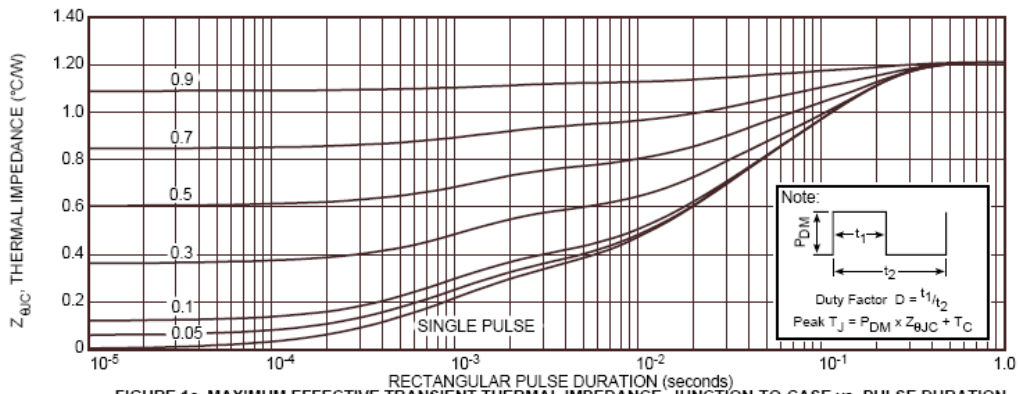

FIGURE 1b, TRANSIENT THERMAL IMPEDANCE MODEL

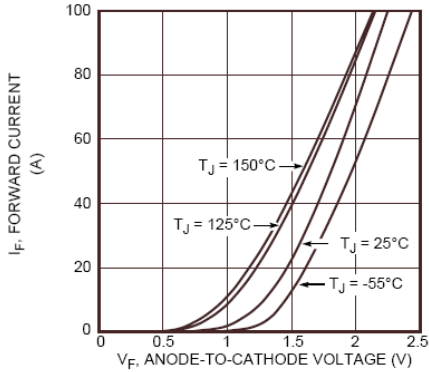

Figure 2. Forward Current vs. Forward Voltage

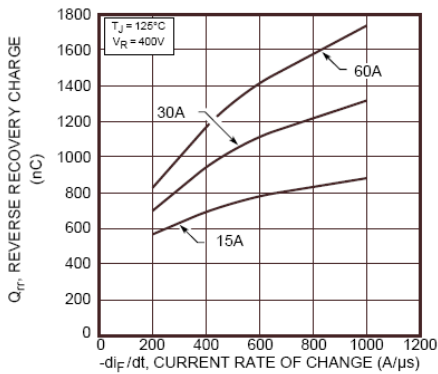

Figure 4. Reverse Recovery Charge vs. Current Rate of Change

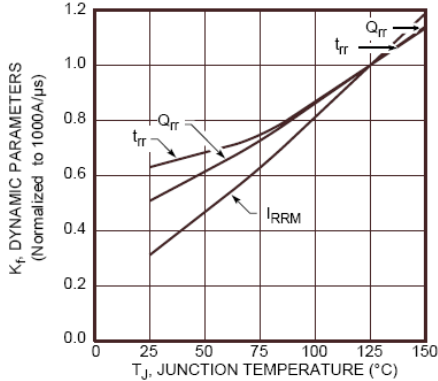

Figure 6. Dynamic Parameters vs. Junction Temperature

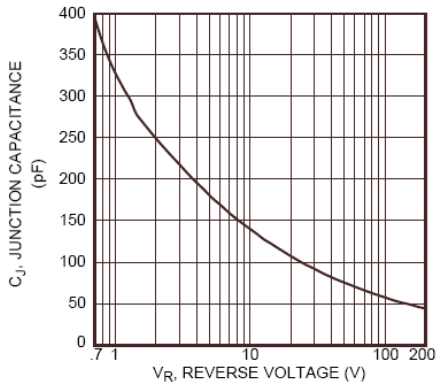

Figure 8. Junction Capacitance vs. Reverse Voltage

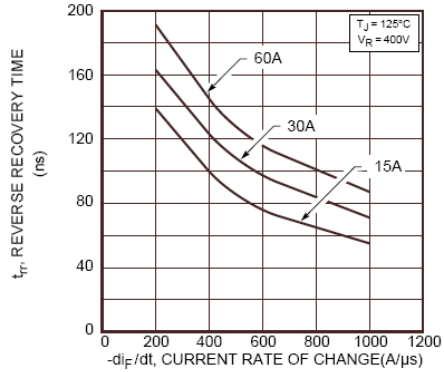

Figure 3. Reverse Recovery Time vs. Current Rate of Change

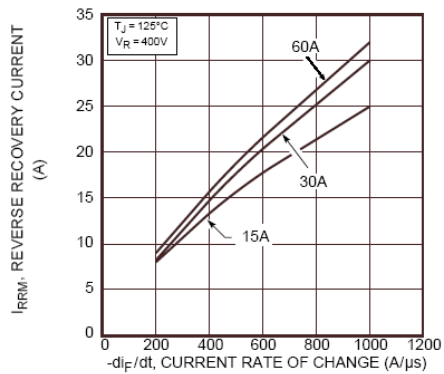

Figure 5. Reverse Recovery Current vs. Current Rate of Change

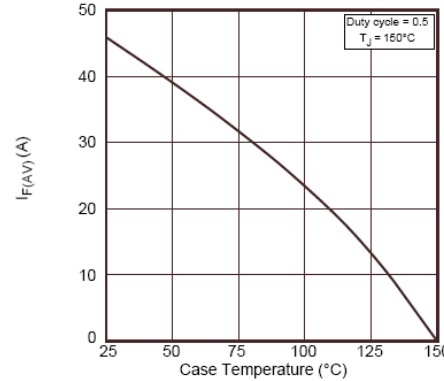

Figure 7. Maximum Average Forward Current vs. Case Temperature

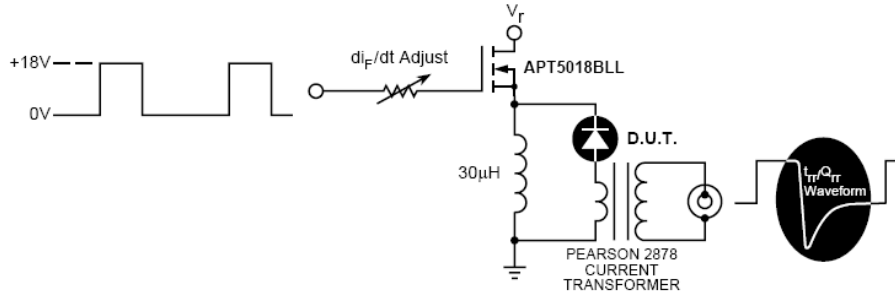

Figure 9. Diode Test Circuit

- ❶  $I_F$  - Forward Conduction Current
- ❷  $di_F/dt$  - Rate of Diode Current Change Through Zero Crossing.
- ❸  $I_{RRM}$  - Maximum Reverse Recovery Current.
- ❹  $t_{rr}$  - Reverse Recovery Time, measured from zero crossing where diode current goes from positive to negative, to the point at which the straight line through  $I_{RRM}$  and  $0.25 \cdot I_{RRM}$  passes through zero.
- ❺  $Q_{rr}$  - Area Under the Curve Defined by  $I_{RRM}$  and  $t_{rr}$ .

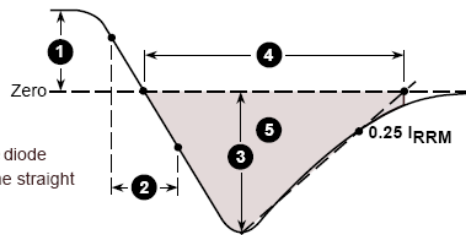
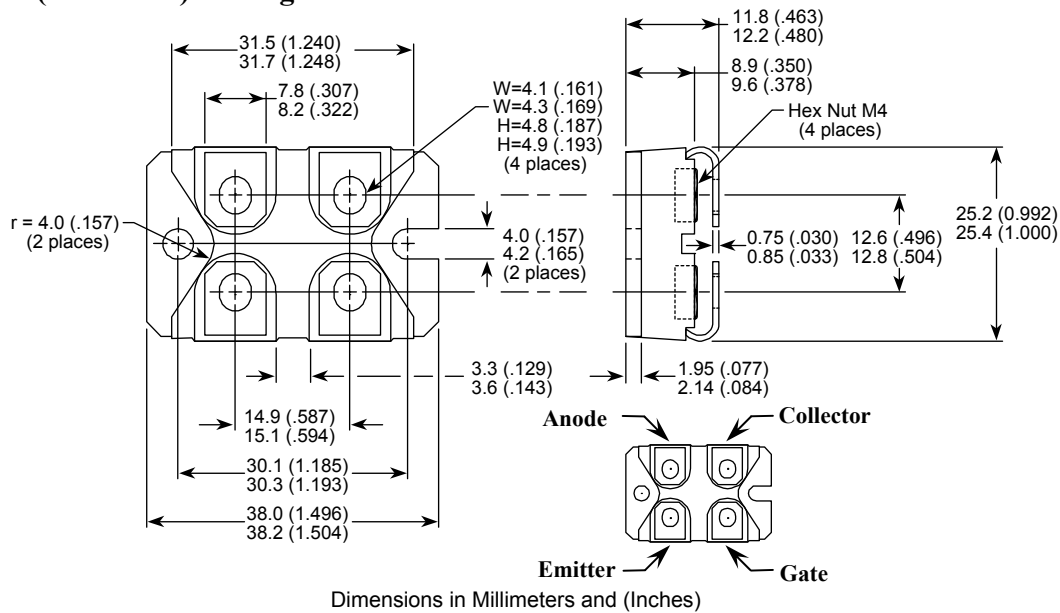

Figure 10. Diode Reverse Recovery Waveform and Definitions

**SOT-227 (ISOTOP®) Package Outline**



ISOTOP® is a registered trademark of ST Microelectronics NV



DISCLAIMER

The information contained in the document (unless it is publicly available on the Web without access restrictions) is PROPRIETARY AND CONFIDENTIAL information of Microsemi and cannot be copied, published, uploaded, posted, transmitted, distributed or disclosed or used without the express duly signed written consent of Microsemi. If the recipient of this document has entered into a disclosure agreement with Microsemi, then the terms of such Agreement will also apply. This document and the information contained herein may not be modified, by any person other than authorized personnel of Microsemi. No license under any patent, copyright, trade secret or other intellectual property right is granted to or conferred upon you by disclosure or delivery of the information, either expressly, by implication, inducement, estoppels or otherwise. Any license under such intellectual property rights must be approved by Microsemi in writing signed by an officer of Microsemi.

Microsemi reserves the right to change the configuration, functionality and performance of its products at anytime without any notice. This product has been subject to limited testing and should not be used in conjunction with life-support or other mission-critical equipment or applications. Microsemi assumes no liability whatsoever, and Microsemi disclaims any express or implied warranty, relating to sale and/or use of Microsemi products including liability or warranties relating to fitness for a particular purpose, merchantability, or infringement of any patent, copyright or other intellectual property right. Any performance specifications believed to be reliable but are not verified and customer or user must conduct and complete all performance and other testing of this product as well as any user or customers final application. User or customer shall not rely on any data and performance specifications or parameters provided by Microsemi. It is the customer's and user's responsibility to independently determine suitability of any Microsemi product and to test and verify the same. The information contained herein is provided "AS IS, WHERE IS" and with all faults, and the entire risk associated with such information is entirely with the User. Microsemi specifically disclaims any liability of any kind including for consequential, incidental and punitive damages as well as lost profit. The product is subject to other terms and conditions which can be located on the web at <http://www.microsemi.com/legal/tnc.asp>

Life Support Application

Seller's Products are not designed, intended, or authorized for use as components in systems intended for space, aviation, surgical implant into the body, in other applications intended to support or sustain life, or for any other application in which the failure of the Seller's Product could create a situation where personal injury, death or property damage or loss may occur (collectively "Life Support Applications").

Buyer agrees not to use Products in any Life Support Applications and to the extent it does it shall conduct extensive testing of the Product in such applications and further agrees to indemnify and hold Seller, and its officers, employees, subsidiaries, affiliates, agents, sales representatives and distributors harmless against all claims, costs, damages and expenses, and attorneys' fees and costs arising, directly or indirectly, out of any claims of personal injury, death, damage or otherwise associated with the use of the goods in Life Support Applications, even if such claim includes allegations that Seller was negligent regarding the design or manufacture of the goods.

Buyer must notify Seller in writing before using Seller's Products in Life Support Applications. Seller will study with Buyer alternative solutions to meet Buyer application specification based on Sellers sales conditions applicable for the new proposed specific part.