

### FEATURES

- Optimised bipolar output voltages for IGBT/ Mosfet gate drives
- Reinforced insulation to UL60950 recognised
- ANSI/AAMI ES60601-1, 1 MOPP/2 MOOP's recognised
- 5.2kVDC isolation test voltage 'Hi Pot Test'
- Ultra low coupling capacitance
- SIP package style
- 5V, 12V, 15V & 24V inputs
- +15V/-15V, +15V/-5V, +15V/-8.7V, +20V/-3.5 & +20V/-5V outputs
- Operation to 100°C
- Characterised dv/dt immunity
- Characterised partial discharge performance

### PRODUCT OVERVIEW

The MGJ2 series of DC-DC converters is ideal for powering 'high side' and 'low side' gate drive circuits for IGBTs and Mosfets in bridge circuits. A choice of asymmetric output voltages allows optimum drive levels for best system efficiency and EMI. The MGJ2 series is characterised for high isolation and dv/dt requirements commonly seen in bridge circuits used in motor drives and inverters, while the MGJ2 industrial grade temperature rating and construction gives long service life and reliability.

### SELECTION GUIDE

| Order Code    | Nominal Input Voltage | Output Voltage 1 | Output Voltage 2 | Output Current 1 | Output Current 2 | Input Current at Rated Load | Load Regulation (Typ) | Load Regulation (Max) | Ripple & Noise (Typ) <sup>2</sup> | Ripple & Noise (Max) <sup>2</sup> | Efficiency (Min) | Efficiency (Typ) | Isolation Capacitance | MTTF <sup>1</sup> |           |
|---------------|-----------------------|------------------|------------------|------------------|------------------|-----------------------------|-----------------------|-----------------------|-----------------------------------|-----------------------------------|------------------|------------------|-----------------------|-------------------|-----------|
|               | V                     | V                | V                |                  | mA               |                             | %                     |                       | mVp-p                             |                                   | %                | pF               |                       | MIL. kHrs         | Tel. kHrs |
| MGJ2D051505SC | 5                     | 15               | -5               | 80               | 40               | 360                         | 5.7                   | 7                     | 30                                | 50                                | 71               | 76               | 2.8                   | 2095              |           |
| MGJ2D051509SC | 5                     | 15               | -8.7             | 80               | 40               | 390                         | 6                     | 7                     | 30                                | 50                                | 73               | 77.5             | 3.3                   | 1902              |           |
| MGJ2D051515SC | 5                     | 15               | -15              | 67               | 67               | 492                         | 6.5                   | 7                     | 20                                | 35                                | 76               | 79               | 4                     | 2629              |           |
| MGJ2D052005SC | 5                     | 20               | -5               | 80               | 40               | 440                         | 6.2                   | 8                     | 30                                | 50                                | 74               | 78.5             | 3.3                   | 1655              |           |
| MGJ2D121505SC | 12                    | 15               | -5               | 80               | 40               | 150                         | 4.7                   | 6                     | 30                                | 50                                | 76               | 80               | 2.9                   | 2339              |           |
| MGJ2D121509SC | 12                    | 15               | -8.7             | 80               | 40               | 155                         | 5.3                   | 7.5                   | 30                                | 50                                | 76               | 80               | 3.5                   | 2296              |           |
| MGJ2D121515SC | 12                    | 15               | -15              | 67               | 67               | 203                         | 6.0                   | 7                     | 24                                | 40                                | 78               | 82               | 4                     | 2707              |           |
| MGJ2D122005SC | 12                    | 20               | -5               | 80               | 40               | 195                         | 5.5                   | 8                     | 30                                | 45                                | 78               | 82               | 3.3                   | 1799              |           |
| MGJ2D151505SC | 15                    | 15               | -5               | 80               | 40               | 120                         | 5                     | 7                     | 30                                | 50                                | 75               | 80               | 2.9                   | 2374              |           |
| MGJ2D151509SC | 15                    | 15               | -8.7             | 80               | 40               | 130                         | 5                     | 7                     | 30                                | 50                                | 76               | 80               | 4                     | 2736              |           |
| MGJ2D151515SC | 15                    | 15               | -15              | 67               | 67               | 167                         | 5.5                   | 7                     | 23                                | 35                                | 75               | 79               | 4                     | 2100              |           |
| MGJ2D152003SC | 15                    | 20               | -3.5             | 80               | 80               | 150                         | 7                     | 10                    | 30                                | 50                                | 76               | 81               | 3                     | 2000              | 80000     |
| MGJ2D152005SC | 15                    | 20               | -5               | 80               | 40               | 145                         | 6                     | 8                     | 30                                | 50                                | 78               | 81               | 3.4                   | 1864              |           |
| MGJ2D241505SC | 24                    | 15               | -5               | 80               | 40               | 75                          | 4.6                   | 7                     | 30                                | 50                                | 75               | 80.5             | 2.7                   | 2194              |           |
| MGJ2D241509SC | 24                    | 15               | -8.7             | 80               | 40               | 80                          | 4.8                   | 7                     | 30                                | 50                                | 77               | 82               | 3.5                   | 2275              |           |
| MGJ2D242005SC | 24                    | 20               | -5               | 80               | 40               | 90                          | 6                     | 8                     | 30                                | 50                                | 78               | 82               | 3.5                   | 1725              |           |

### INPUT CHARACTERISTICS

| Parameter              | Conditions                            | Min. | Typ. | Max. | Units |
|------------------------|---------------------------------------|------|------|------|-------|
| Voltage range          | Continuous operation, 5V input types  | 4.5  | 5    | 5.5  | V     |
|                        | Continuous operation, 12V input types | 10.8 | 12   | 13.2 |       |
|                        | Continuous operation, 15V input types | 13.5 | 15   | 16.5 |       |
|                        | Continuous operation, 24V input types | 21.6 | 24   | 26.4 |       |
| Input reflected ripple | 5V input types                        |      | 40   |      | mA    |
|                        | 12V & 15V input types                 |      | 20   |      |       |
|                        | 24V input types                       |      | 15   |      |       |

### OUTPUT CHARACTERISTICS

| Parameter                  | Conditions                                  | Min. | Typ. | Max. | Units |
|----------------------------|---|------|------|------|-------|
| Rated Power                | T <sub>A</sub> = -40°C to 100°C             |      |      | 2    | W     |
| Voltage Set Point Accuracy | See tolerance envelopes                     |      |      |      |       |
| Line regulation            | High V <sub>IN</sub> to low V <sub>IN</sub> |      | 1.0  | 1.2  | %/%   |

### ABSOLUTE MAXIMUM RATINGS

|   |            |
|---|------------|
| Short-circuit protection                      | Continuous |
| Lead temperature 1mm from case for 10 seconds | 260°C      |
| Input voltage V <sub>IN</sub> , MGJ2D05xxxxSC | 5.5V       |
| Input voltage V <sub>IN</sub> , MGJ2D12xxxxSC | 13.2V      |
| Input voltage V <sub>IN</sub> , MGJ2D15xxxxSC | 16.5V      |
| Input voltage V <sub>IN</sub> , MGJ2D24xxxxSC | 26.4V      |

### ISOLATION CHARACTERISTICS

| Parameter              | Conditions                | Min. | Typ. | Max. | Units |
|------------------------|---------------------------|------|------|------|-------|
| Isolation test voltage | Flash tested for 1 second | 5200 |      |      | VDC   |
| Resistance             | Viso= 500VDC              |      | 1    |      | GΩ    |

1. Calculated using MIL-HDBK-217 FN2 calculation model with nominal input voltage at full load.
2. See ripple & noise test method.

All specifications typical at T<sub>A</sub>=25°C, nominal input voltage and rated output current unless otherwise specified.



For full details go to [www.murata-ps.com/rohs](http://www.murata-ps.com/rohs)



### GENERAL CHARACTERISTICS

| Parameter           | Conditions | Min. | Typ. | Max. | Units |
|---------------------|------------|------|------|------|-------|
| Switching frequency | All types  |      | 45   |      | kHz   |

### TEMPERATURE CHARACTERISTICS

| Parameter                      | Conditions   | Min. | Typ. | Max. | Units |
|--------------------------------|--|------|------|------|-------|
| Specification                  | All output types (see safety approval section for limitations) | -40  |      | 100  | °C    |
| Storage                        |  | -55  |      | 125  |       |
| Case Temperature above ambient | 5V input types   |      | 24   |      |       |
|                                | All other input types  |      | 20   |      |       |
| Cooling                        | Free air convection  |      |      |      |       |

### TEMPERATURE DERATING GRAPHS

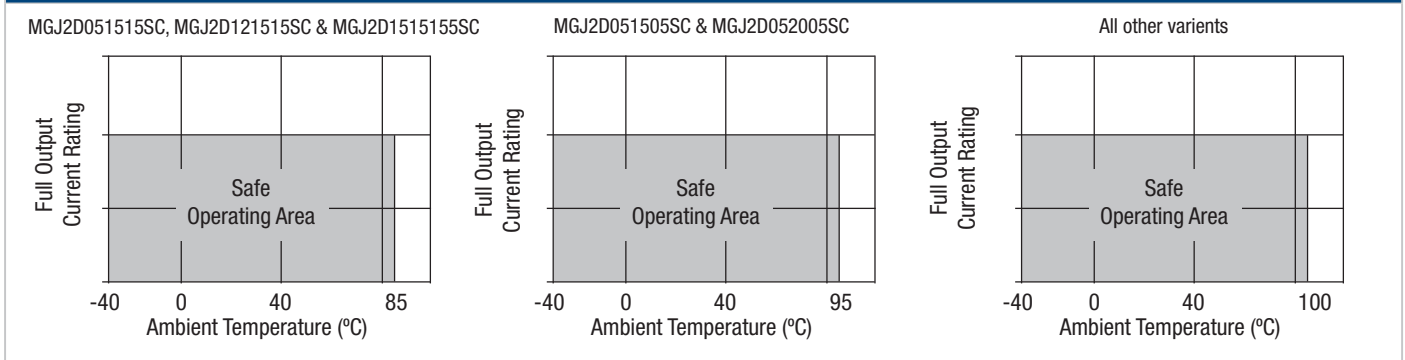

**POSITIVE OUTPUT VOLTAGE TOLERANCE ENVELOPES**

The voltage tolerance envelopes show typical load regulation characteristics for this product series. The tolerance envelope is the maximum output voltage variation due to changes in output loading and set point accuracy.

**MGJ2D051505SC, MGJ2D051509SC, MGJ2D151505SC & MGJ2D151509SC**

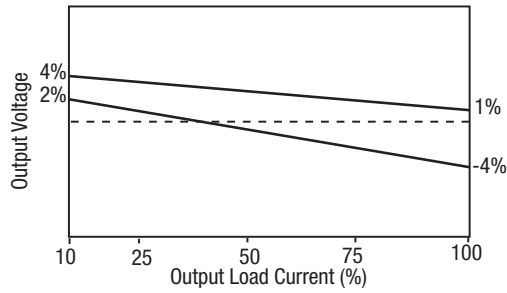

**MGJ2D122005SC, MGJ2D152005SC & MGJ2D242005SC**

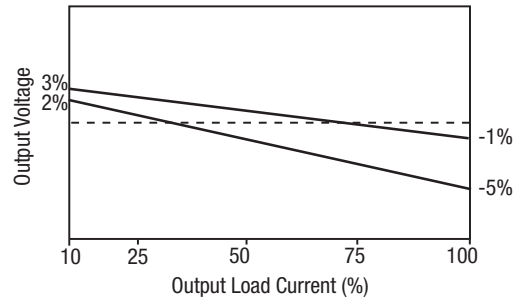

**MGJ2D121509SC, MGJ2D241509SC & MGJ2D052005SC**

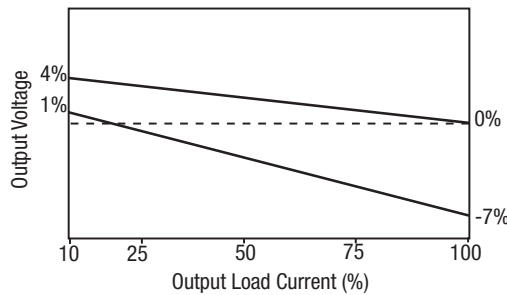

**MGJ2D121505SC & MGJ2D241505SC**

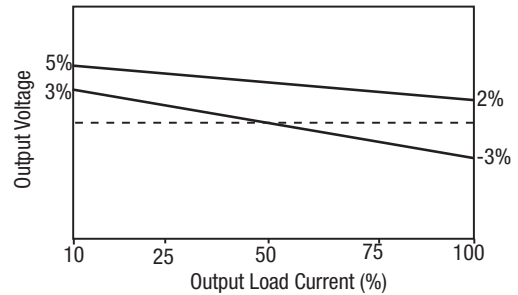

**MGJ2D051515SC, MGJ2D121515SC & MGJ2D151515SC**

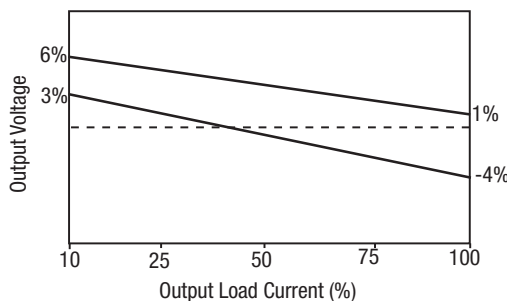

**MGJ2D152003SC**

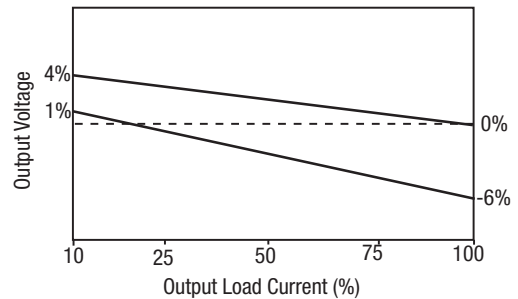

**NEGATIVE OUTPUT VOLTAGE TOLERANCE ENVELOPES**

**MGJ2D051509SC, MGJ2D052005SC & MGJ2D121505SC, MGJ2D-122005SC, MGJ2D152005SC & MGJ2D242005SC**

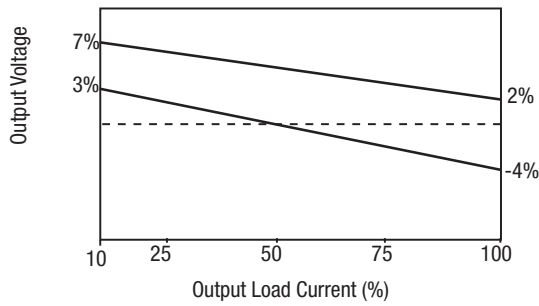

**MGJ2D151505SC**

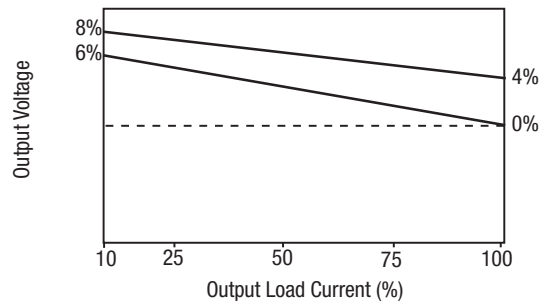

**MGJ2D121509SC & MGJ2D241509SC**

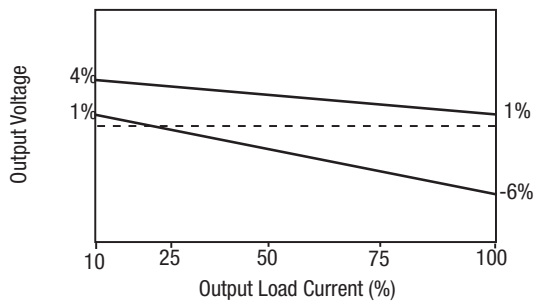

**MGJ2D051505SC**

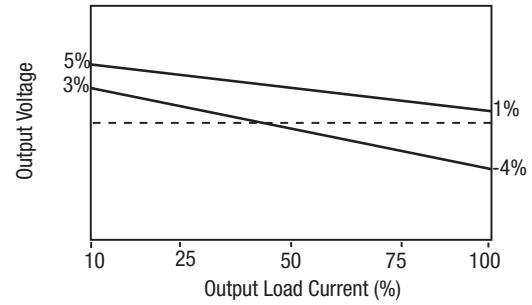

**MGJ2D151509SC & MGJ2D241505SC**

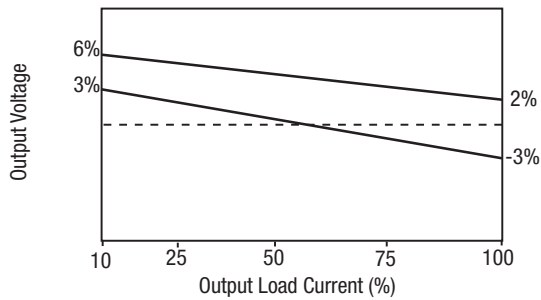

**MGJ2D051515SC, MGJ2D121515SC & MGJ2D151515SC**

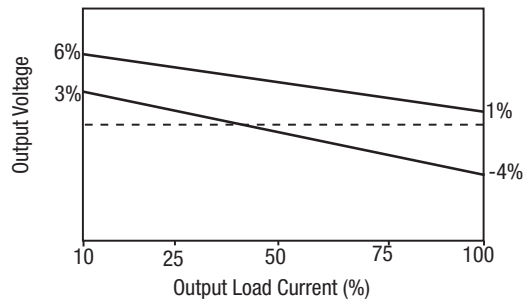

**NEGATIVE OUTPUT VOLTAGE TOLERANCE ENVELOPES Continued**

**MGJ2D152003SC**

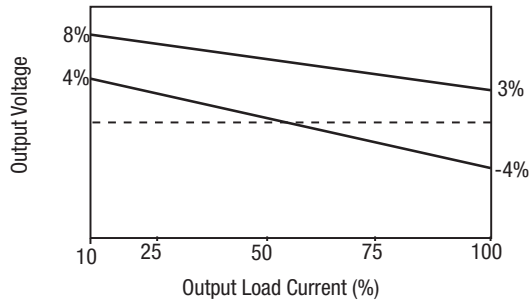

### TECHNICAL NOTES

#### ISOLATION VOLTAGE

'Hi Pot Test', 'Flash Tested', 'Withstand Voltage', 'Proof Voltage', 'Dielectric Withstand Voltage' & 'Isolation Test Voltage' are all terms that relate to the same thing, a test voltage, applied for a specified time, across a component designed to provide electrical isolation, to verify the integrity of that isolation.

Murata Power Solutions MGJ2 series of DC/DC converters are all 100% production tested at their stated isolation voltage. This is 5.2kVDC for 1 second.

A question commonly asked is, "What is the continuous voltage that can be applied across the part in normal operation?"

When the insulation in the MGJ2 series is not used as a safety barrier, i.e. provides functional isolation only, continuous or switched voltages across the barrier in excess of 1.5kV are sustainable. Long term reliability testing at these voltages continues. Please contact Murata for further information.

The MGJ2 series is recognised by Underwriters Laboratory for various voltages, please see safety approval section below.

#### REPEATED HIGH-VOLTAGE ISOLATION TESTING

It is well known that repeated high-voltage isolation testing of a barrier component can actually degrade isolation capability, to a lesser or greater degree depending on materials, construction and environment. We therefore strongly advise against repeated high voltage isolation testing, but if it is absolutely required, that the voltage be reduced by 20% from specified test voltage.

### SAFETY APPROVAL

#### ANSI/AAMI ES60601-1

The MGJ2 series has been recognised by Underwriters Laboratory (UL) to ANSI/AAMI ES60601-1 and provides 1 MOOP (Means Of Operator Protection) based on a working voltage of 300Vrms or 2 MOOP based upon a working voltage of 200 Vrms, and 1 MOPP (Mean Of Patient Protection) based on a working voltage of 200Vrms., between Primary and Secondary. File number E202895 applies.

#### UL 60950

The MGJ2 series is recognised by Underwriters Laboratory (UL) to UL 60950 for reinforced insulation to a working voltage of 200Vrms and for basic/supplementary insulation to a working voltage of 300Vrms. File number E151252 applies.

#### Fusing

The MGJ2 Series of converters are not internally fused so to meet the requirements of UL an anti-surge input line fuse should always be used with ratings as defined below.

MGJ2x05xxxC: 1.25A

MGJ2x12xxxC: 750mA

MGJ2x15xxxC: 750mA

MGJ2x24xxxC: 750mA

All fuses should be UL recognized and rated to 125V.

### RoHS COMPLIANCE INFORMATION



This series is compatible with RoHS soldering systems with a peak wave solder temperature of 260°C for 10 seconds. The pin termination finish on this product series is Tin Plate, Hot Dipped over Matte Tin with Nickel Preplate. The series is backward compatible with Sn/Pb soldering systems. For further information, please visit [www.murata-ps.com/rohs](http://www.murata-ps.com/rohs)

**APPLICATION NOTES**

**Minimum load**

The minimum load to meet datasheet specification is 10% of the full rated load across the specified input voltage range. Lower than 10% minimum loading will result in an increase in output voltage, which may rise to typically 1.25 times the specified output voltage if the output load falls to less than 5%.

**Capacitive loading and start up**

Typical start up times for this series, with a typical input voltage rise time of 2.2µs and output capacitance of 10µF, are shown in the table below. The product series will start into capacitance ranging from 47µF up to 220µF with increased start times.

|               | Start-up time |
|---------------|---------------|
|               | ms            |
| MGJ2D051505SC | 3.3           |
| MGJ2D051509SC | 4.5           |
| MGJ2D051515SC | 20.84         |
| MGJ2D052005SC | 5.4           |
| MGJ2D121505SC | 3.2           |
| MGJ2D121509SC | 4             |
| MGJ2D121515SC | 14.54         |
| MGJ2D122005SC | 5.5           |
| MGJ2D151505SC | 2.5           |
| MGJ2D151509SC | 3             |
| MGJ2D151515SC | 10.48         |
| MGJ2D152003SC | 4.5           |
| MGJ2D152005SC | 4.5           |
| MGJ2D241505SC | 2.7           |
| MGJ2D241509SC | 3             |
| MGJ2D242005SC | 4.2           |

Typical Start-Up Wave Form

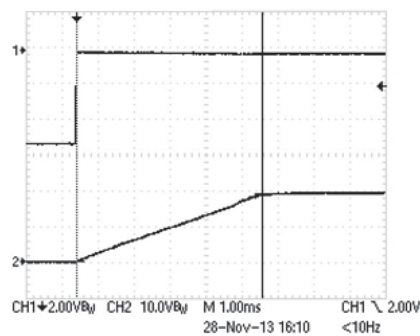

**Ripple & Noise Characterisation Method**

Ripple and noise measurements are performed with the following test configuration.

|       |  |
|-------|--|
| C1    | 1µF X7R multilayer ceramic capacitor, voltage rating to be a minimum of 3 times the output voltage of the DC/DC converter                                |
| C2    | 10µF tantalum capacitor, voltage rating to be a minimum of 1.5 times the output voltage of the DC/DC converter with an ESR of less than 100mΩ at 100 kHz |
| C3    | 100nF multilayer ceramic capacitor, general purpose  |
| R1    | 450Ω resistor, carbon film, ±1% tolerance  |
| R2    | 50Ω BNC termination  |
| T1    | 3T of the coax cable through a ferrite toroid  |
| RLOAD | Resistive load to the maximum power rating of the DC/DC converter. Connections should be made via twisted wires  |

Measured values are multiplied by 10 to obtain the specified values.

**Differential Mode Noise Test Schematic**

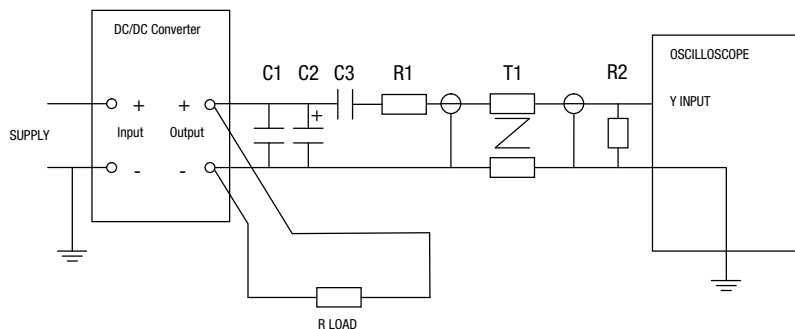

### EFFICIENCY VS LOAD

**5V INPUT**

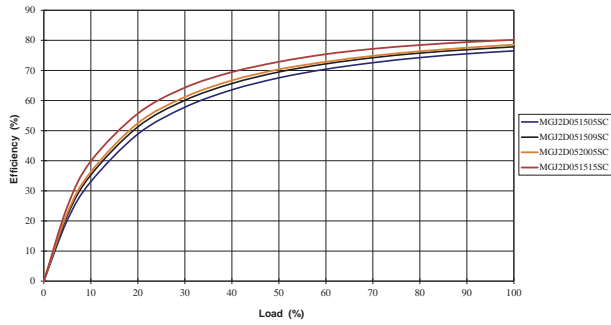

**12V INPUT**

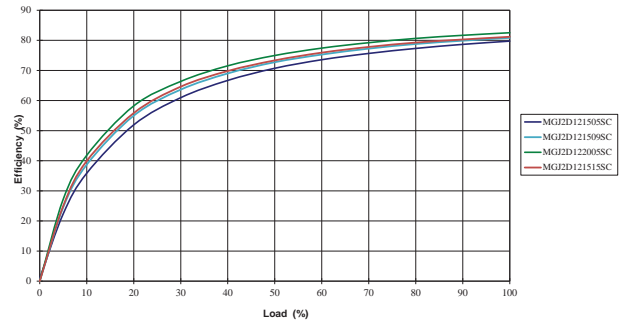

**15V INPUT**

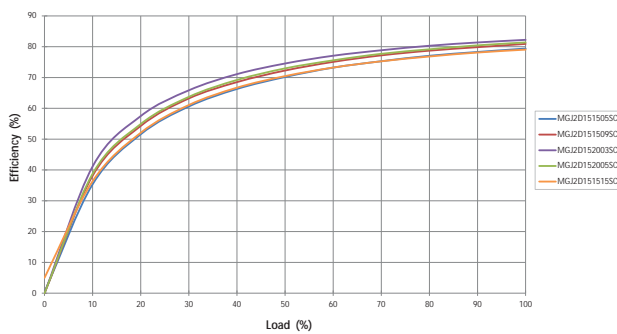

**24V INPUT**

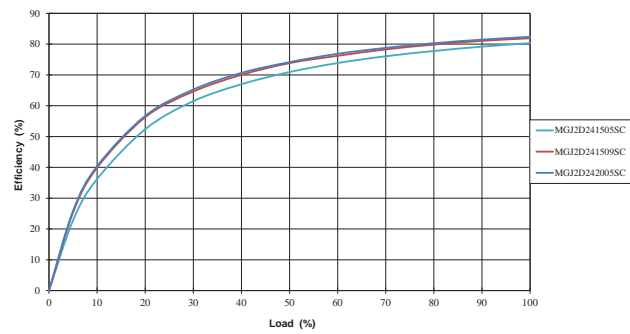



**PACKAGE SPECIFICATIONS**

**MECHANICAL DIMENSIONS**

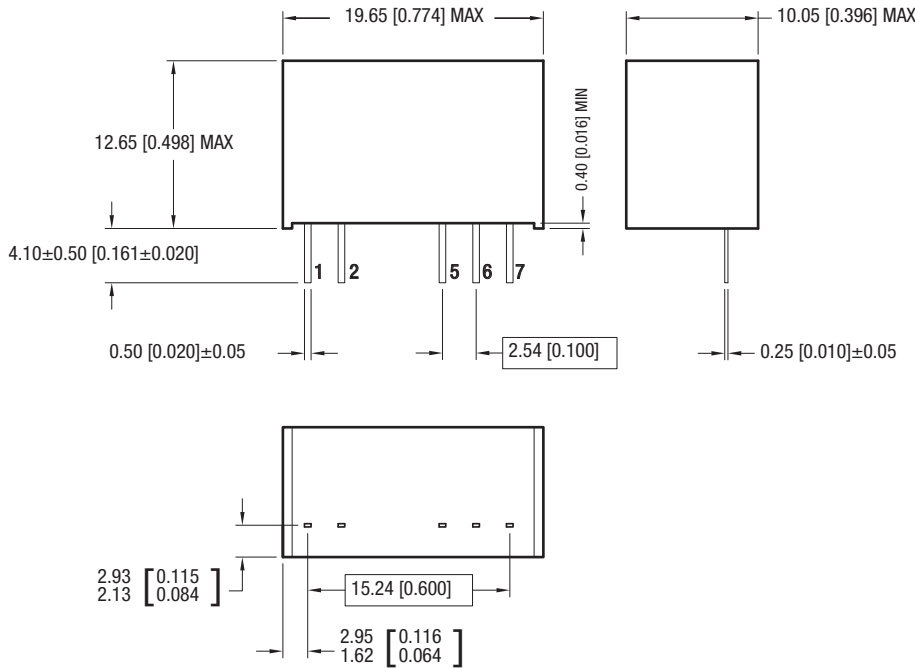

All dimensions in mm  $\pm 0.25$ mm (inches  $\pm 0.01$ ). All pins on a 2.54 (0.1) pitch and within  $\pm 0.25$  (0.01) of true position.

Weight: 4.3g

**PIN CONNECTIONS**

**Pin Output**

| Pin | Function |
|-----|----------|
| 1   | +VIN     |
| 2   | -VIN     |
| 5   | -VOUT    |
| 6   | OV       |
| 7   | +VOUT    |

**TUBE OUTLINE DIMENSIONS**

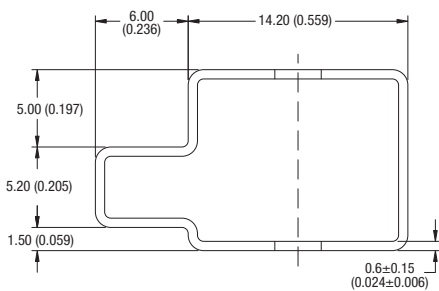

Unless otherwise stated all dimensions in mm  $\pm 0.5$ mm (inches  $\pm 0.02$ ).  
Tube length : 20.669 $\pm$ 0.079 (525mm $\pm$ 2mm).

Tube Quantity : 25

**RECOMMENDED FOOTPRINT DETAILS**

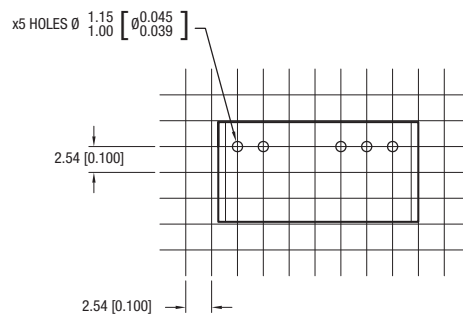

All dimensions in mm  $\pm 0.25$ mm (inches  $\pm 0.01$ ).

Murata Power Solutions, Inc.  
11 Cabot Boulevard, Mansfield, MA 02048-1151 U.S.A.  
ISO 9001 and 14001 REGISTERED



This product is subject to the following **operating requirements** and the **Life and Safety Critical Application Sales Policy**:  
Refer to: <http://www.murata-ps.com/requirements/>

Murata Power Solutions, Inc. makes no representation that the use of its products in the circuits described herein, or the use of other technical information contained herein, will not infringe upon existing or future patent rights. The descriptions contained herein do not imply the granting of licenses to make, use, or sell equipment constructed in accordance therewith. Specifications are subject to change without notice.  
© 2017 Murata Power Solutions, Inc.