



FEATURES

- UL60950 recognised
- Single isolated output
- 1kVDC isolation
- Efficiency up to 87%
- Wide temperature performance at full 1 watt load, -40°C to 85°C
- Power density 2.62W/cm³
- 3.3V, 5V, and 12V input
- 3.3V, 5V, 9V, 12V and 15V output
- Custom solutions available
- PCB mounting
- Footprint reduction of over 26% from previous generations of 1W DC/DC's

DESCRIPTION

The MEU1 series is a new range of ultra miniature through hole 1W DC/DC converters, available in a ZIP style pinout. The MEU1 series offers 1W of available output power over the industrial temperature range of -40°C to 85°C. They are ideally suited for providing local supplies on control system boards.

With the added benefit of 1kVDC galvanic isolation to reduce switching noise and allows the device to be configured to provide an isolated negative rail in systems where only positive rails exist.

SELECTION GUIDE

Order Code	Nominal Input Voltage	Output Voltage	Output Current	Load Regulation (Typ.)	Load Regulation (Max.)	Ripple & Noise (Typ.)	Ripple & Noise (Max.)	Input Current at Rated Load	Efficiency (Min.)	Efficiency (Typ.)	Isolation Capacitance (Typ.)	MTTF
	V	V	mA	%	%	mVp-p	mVp-p	mA	%	%	pF	kHrs
MEU1S0303ZC	3.3	3.3	303	11	14	27	50	385	73	76	28	3084
MEU1S0305ZC	3.3	5	200	9	12	21	45	373	76	79	30	3125
MEU1S0309ZC	3.3	9	111	10	13	16	40	376	75	79	34	3960
MEU1S0312ZC	3.3	12	83	9	12	15	40	369	77	81	40	3343
MEU1S0315ZC	3.3	15	67	8	10	14	40	371	77	81	33	3140
MEU1S0503ZC	5	3.3	303	9	12	26	50	249	74	77	29	2762
MEU1S0505ZC	5	5	200	7	9	19	45	244	78	81	34	3354
MEU1S0509ZC	5	9	111	9	12	17	40	245	77	81	47	2952
MEU1S0512ZC	5	12	83	8	10	17	40	239	78	83	45	3317
MEU1S0515ZC	5	15	67	6	8	12	35	239	78	83	39	2600
MEU1S1205ZC	12	5	200	5	7	21	45	100	79	83	43	3742
MEU1S1209ZC	12	9	111	6	9	17	40	100	80	84	71	2732
MEU1S1212ZC	12	12	83	5	7	15	40	100	82	86	91	2438
MEU1S1215ZC	12	15	67	4	6	15	40	100	84	87	91	2980

INPUT CHARACTERISTICS

Parameter	Conditions	Min.	Typ.	Max.	Units
Voltage range	Continuous operation, 3.3V input types	2.97	3.3	3.63	V
	Continuous operation, 5V input types	4.5	5.0	5.5	
	Continuous operation, 12V input types	10.8	12.0	13.2	
Reflected ripple current	3.3V & 5V Input types		3	15	mA p-p
	12V Input types		5	15	

OUTPUT CHARACTERISTICS

Parameter	Conditions	Min.	Typ.	Max.	Units
Rated Power	T _A = -40°C to 85°C			1.0	W
Voltage Set Point Accuracy	See tolerance envelope				
Line regulation	High V _{IN} to low V _{IN}	0303	1.0	1.25	%/%
		All other types	1.0	1.2	

ISOLATION CHARACTERISTICS

Parameter	Conditions	Min.	Typ.	Max.	Units
Isolation test voltage	Flash tested for 1 second	1000			VDC
Resistance	Viso = 1000VDC	10			GΩ

GENERAL CHARACTERISTICS

Parameter	Conditions	Min.	Typ.	Max.	Units
Switching frequency			85		kHz

1. Calculated using MIL-HDBK-217F FN2 with nominal input voltage at full load.

All specifications typical at T_A = 25°C, nominal input voltage and rated output current unless otherwise specified.



ABSOLUTE MAXIMUM RATINGS

Lead temperature 1.5mm from case for 10 seconds	260°C
Input voltage V_{IN} , MEU1S03 types	5.5V
Input voltage V_{IN} , MEU1S05 types	7V
Input voltage V_{IN} , MEU1S12 types	15V

TEMPERATURE CHARACTERISTICS

Parameter	Conditions	Min.	Typ.	Max.	Units
Specification	All output types	-40		85	°C
Storage		-50		125	
Case Temperature above ambient	MEU1S03 All other types			30 25	
Cooling	Free air convection				

TOLERANCE ENVELOPES

The voltage tolerance envelopes show typical load regulation characteristics for this product series. The tolerance envelope is the maximum output voltage variation due to changes in output loading and set point accuracy.

MEU1S0303ZC

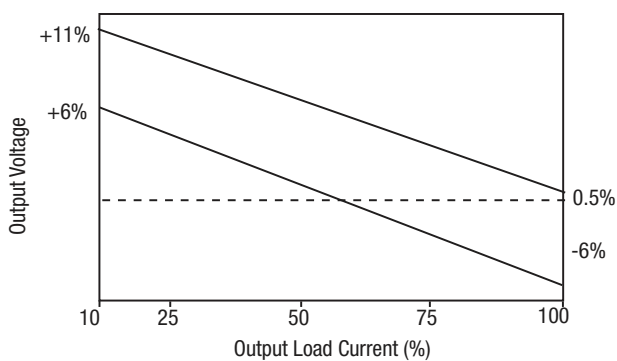

MEU1S0305ZC

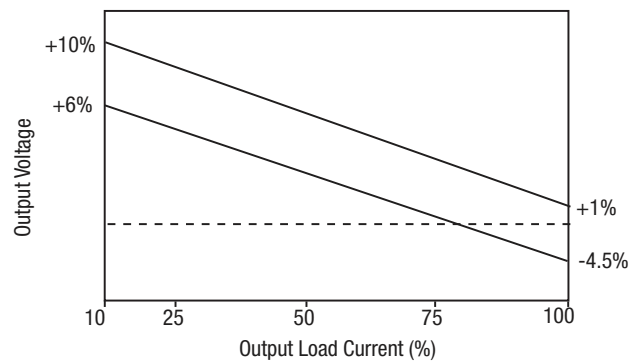

MEU1S0309ZC

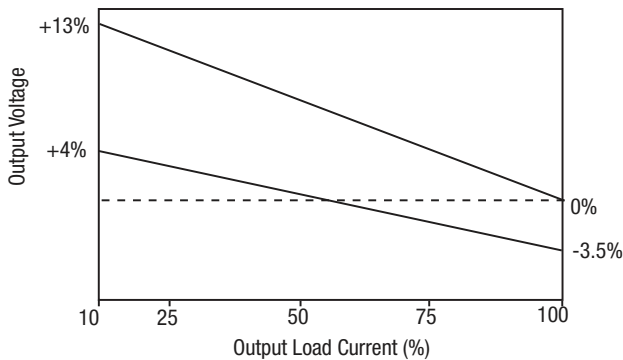

MEU1S0312ZC

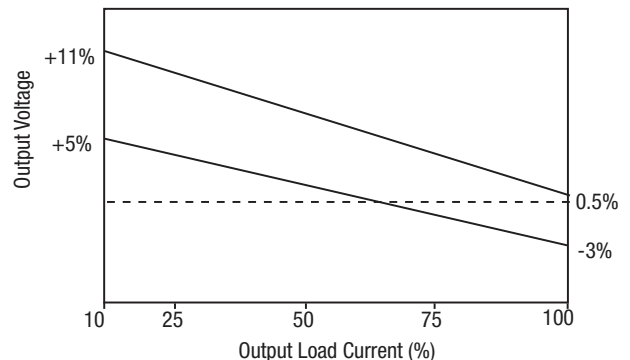

TOLERANCE ENVELOPES

MEU1S0315ZC

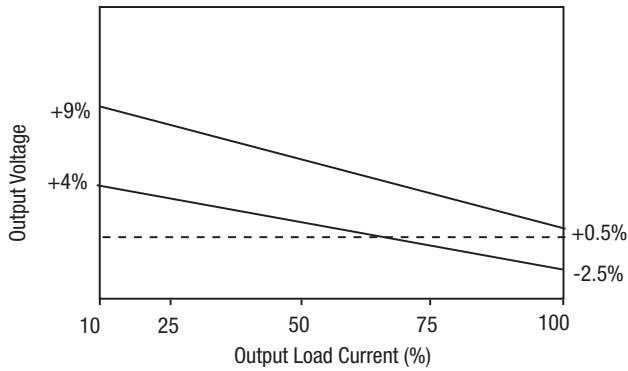

MEU1S0503ZC

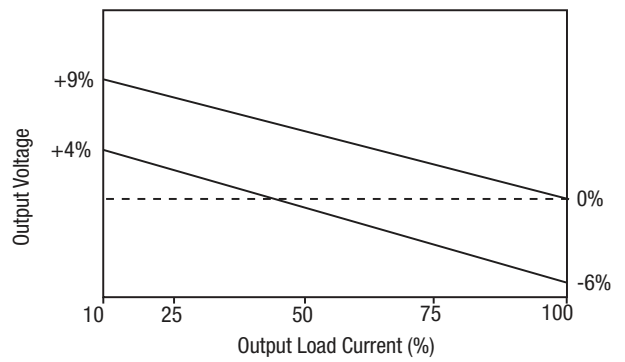

MEU1S0505ZC

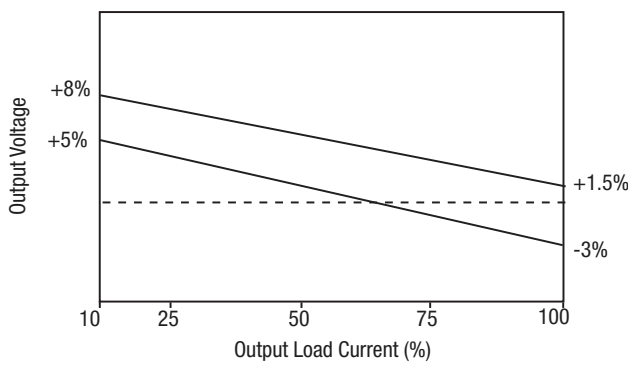

MEU1S0509ZC

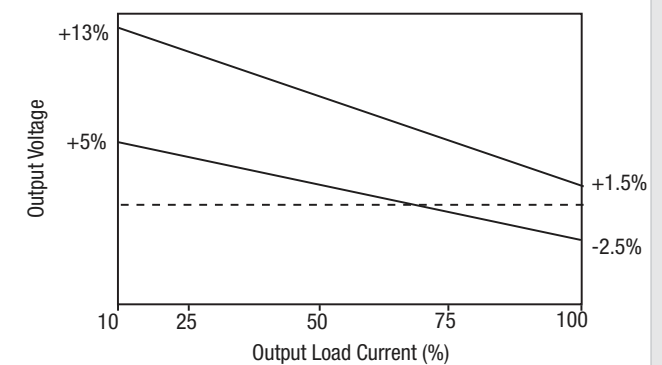

MEU1S0512ZC

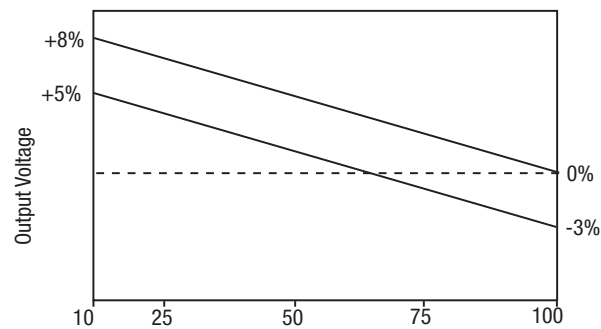

MEU1S0515ZC

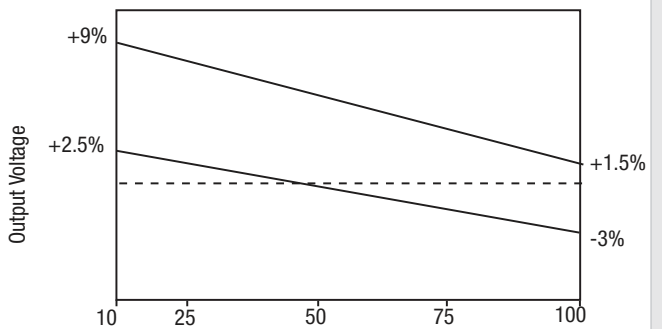

TOLERANCE ENVELOPES

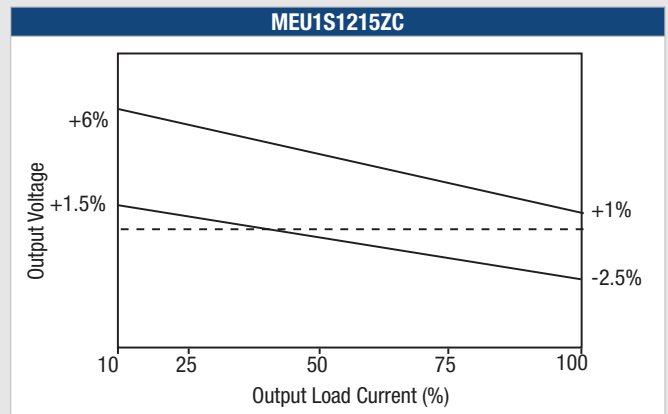
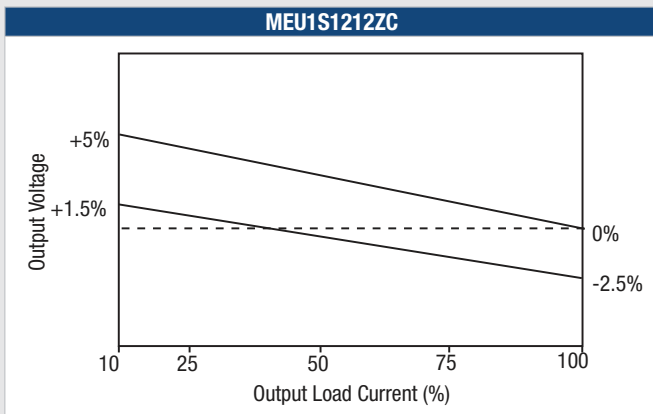
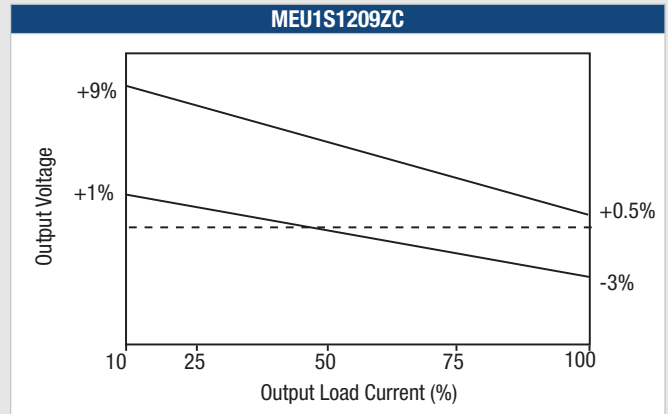
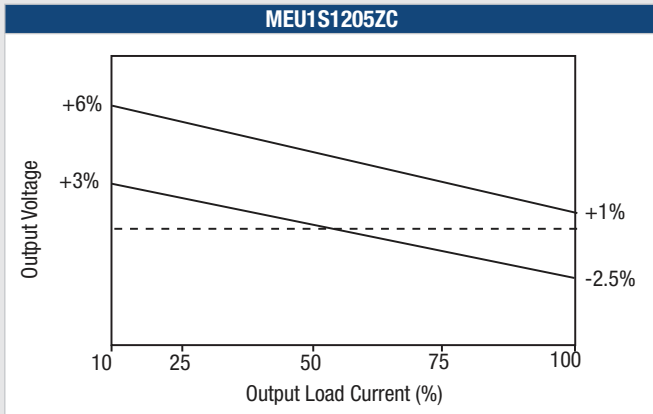

EFFICIENCY VS LOAD

3.3V Input

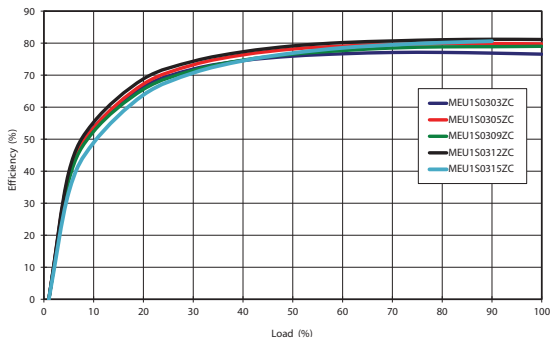

5V Input

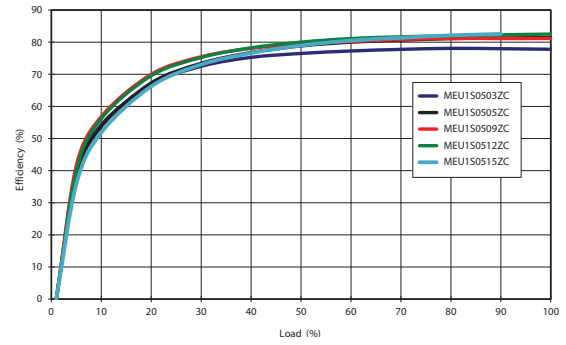

12V Input

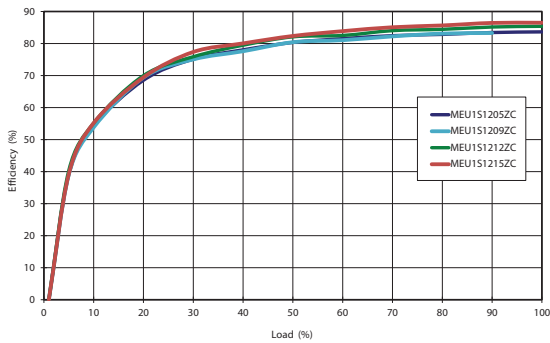

TEMPERATURE DERATING GRAPH

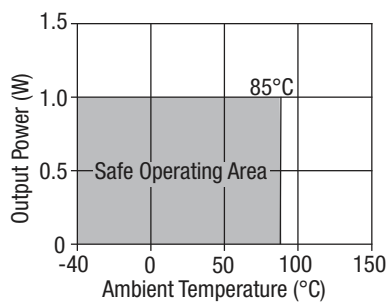

APPLICATION NOTES

Minimum Load

The minimum load to meet datasheet specification is 10% of the full rated load across the specified input voltage range. Lower than 10% minimum loading will result in an increase in output voltage, which may rise to typically 1.25 times the specified output voltage if the output load falls to less than 5%.

Capacitive loading and start up

Typical start up times for this series, with a typical input voltage rise time of 2.2µs and output capacitance of 10µF, are shown in the table below. The product series will start into a capacitance of 47µF with an increased start time, however, the maximum recommended output capacitance is 10µF.

	Start-up time	
	µs	
MEU1S0303ZC	140	
MEU1S0305ZC	280	
MEU1S0309ZC	1050	
MEU1S0312ZC	1930	
MEU1S0315ZC	2790	
MEU1S0503ZC	110	
MEU1S0505ZC	200	
MEU1S0509ZC	490	
MEU1S0512ZC	880	
MEU1S0515ZC	1400	
MEU1S1205ZC	140	
MEU1S1209ZC	240	
MEU1S1212ZC	400	
MEU1S1215ZC	600	

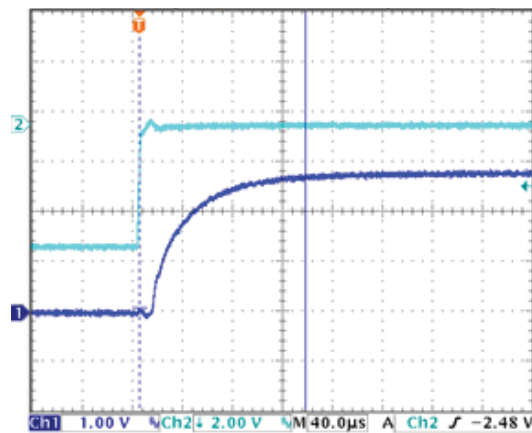

Ripple & Noise Characterisation Method

Ripple and noise measurements are performed with the following test configuration.

C1	1µF X7R multilayer ceramic capacitor, voltage rating to be a minimum of 3 times the output voltage of the DC/DC converter
C2	10µF tantalum capacitor, voltage rating to be a minimum of 1.5 times the output voltage of the DC/DC converter with an ESR of less than 100mΩ at 100 kHz
C3	100nF multilayer ceramic capacitor, general purpose
R1	450Ω resistor, carbon film, ±1% tolerance
R2	50Ω BNC termination
T1	3T of the coax cable through a ferrite toroid
RLOAD	Resistive load to the maximum power rating of the DC/DC converter. Connections should be made via twisted wires
Measured values are multiplied by 10 to obtain the specified values.	

Differential Mode Noise Test Schematic

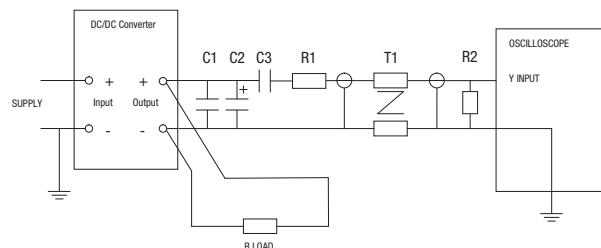

TECHNICAL NOTES

ISOLATION VOLTAGE

'Hi Pot Test', 'Flash Tested', 'Withstand Voltage', 'Proof Voltage', 'Dielectric Withstand Voltage' & 'Isolation Test Voltage' are all terms that relate to the same thing, a test voltage, applied for a specified time, across a component designed to provide electrical isolation, to verify the integrity of that isolation.

Murata Power Solutions MEU1 series of DC/DC converters are all 100% production tested at their stated isolation voltage. This is 1kVDC for 1 second.

A question commonly asked is, "What is the continuous voltage that can be applied across the part in normal operation?"

The MEU1 has been recognized by Underwriters Laboratory for functional insulation, both input and output should normally be maintained within SELV limits i.e. less than 42.4V peak, or 60VDC. The isolation test voltage represents a measure of immunity to transient voltages and the part should never be used as an element of a safety isolation system. The part could be expected to function correctly with several hundred volts offset applied continuously across the isolation barrier; but then the circuitry on both sides of the barrier must be regarded as operating at an unsafe voltage and further isolation/insulation systems must form a barrier between these circuits and any user-accessible circuitry according to safety standard requirements.

REPEATED HIGH-VOLTAGE ISOLATION TESTING

It is well known that repeated high-voltage isolation testing of a barrier component can actually degrade isolation capability, to a lesser or greater degree depending on materials, construction and environment. The MEU1 series has toroidal isolation transformers, with no additional insulation between primary and secondary windings of enameled wire. While parts can be expected to withstand several times the stated test voltage, the isolation capability does depend on the wire insulation. Any material, including this enamel (typically polyurethane) is susceptible to eventual chemical degradation when subject to very high applied voltages thus implying that the number of tests should be strictly limited. We therefore strongly advise against repeated high voltage isolation testing, but if it is absolutely required, that the voltage be reduced by 20% from specified test voltage.

This consideration equally applies to agency recognized parts rated for better than functional isolation where the wire enamel insulation is always supplemented by a further insulation system of physical spacing or barriers.

SAFETY APPROVAL

The MEU1 series has been recognized by Underwriters Laboratory (UL) to UL 60950 for functional insulation, file number E151252 applies. The MEU1 Series of converters are not internally fused so to meet the requirements of UL 60950 an anti-surge input line fuse should always be used with ratings as defined below.

MEU1S03xxxC: 0.50A

MEU1S05xxxC: 0.50A

MEU1S12xxxC: 0.25A

All fuses should be UL approved and rated to at least the maximum allowable DC input voltage.

RoHS COMPLIANCE INFORMATION



This series is compatible with RoHS soldering systems with a peak wave solder temperature of 260°C for 10 seconds. The pin termination finish is Tin Plate, Hot Dipped over Matte Tin with Nickel Preplate. This series are backward compatible with Sn/Pb soldering systems.

For further information, please visit www.murata-ps.com/rohs

PACKAGE SPECIFICATIONS

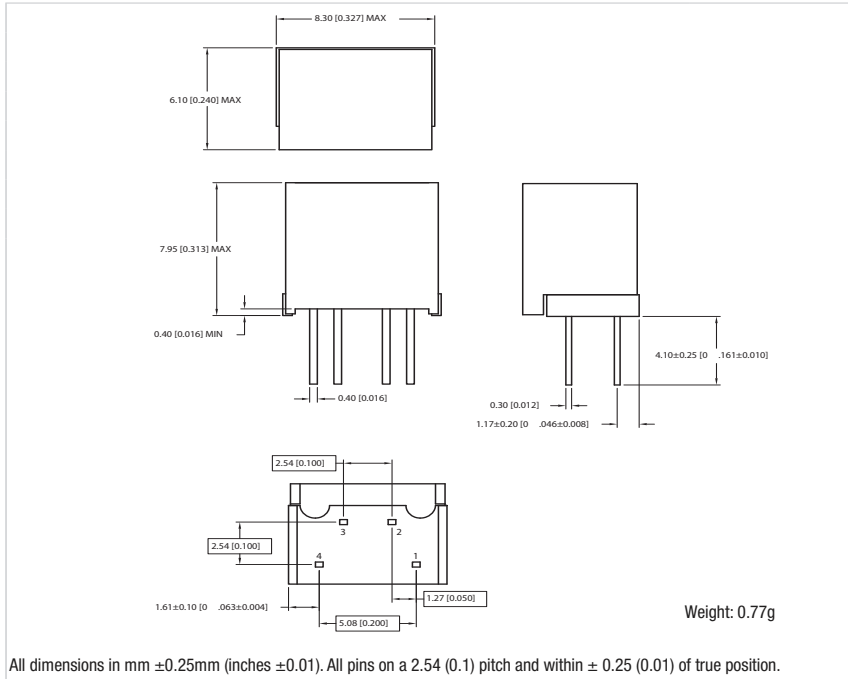

PIN CONNECTIONS - 4 PIN ZIF

Pin	Function
1	-VIN
2	+VIN
3	-VOUT
4	+VOUT

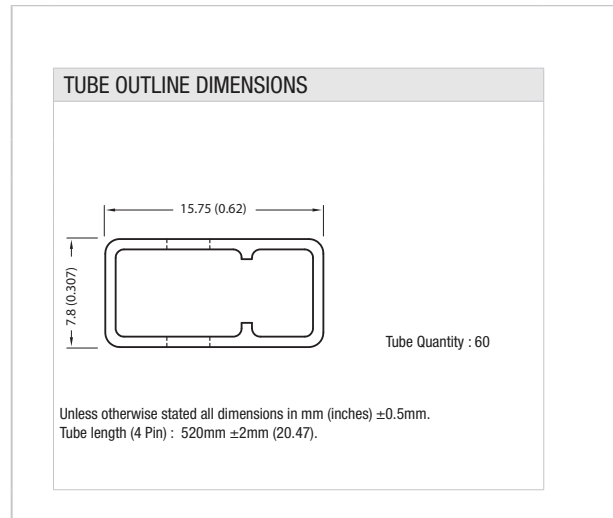
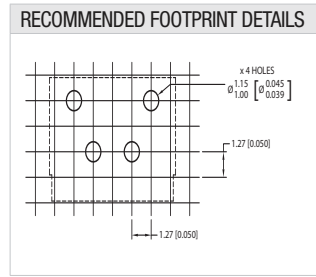

Murata Power Solutions, Inc.
 11 Cabot Boulevard, Mansfield, MA 02048-1151 U.S.A.
 ISO 9001 and 14001 REGISTERED



This product is subject to the following **operating requirements** and the **Life and Safety Critical Application Sales Policy**:
 Refer to: <http://www.murata-ps.com/requirements/>

Murata Power Solutions, Inc. makes no representation that the use of its products in the circuits described herein, or the use of other technical information contained herein, will not infringe upon existing or future patent rights. The descriptions contained herein do not imply the granting of licenses to make, use, or sell equipment constructed in accordance therewith. Specifications are subject to change without notice. © 2013 Murata Power Solutions, Inc.