

### FEATURES

- UL 60950 recognition pending
- 4:1 Wide range voltage input
- Operating temperature range -40°C to 85°C
- Typical load regulation from 0.05%
- 1.5kVDC Isolation 'Hi Pot Test'
- 3.3V, 5V, 12V & 15V outputs
- UL 94V-0 Package materials
- No electrolytic capacitors
- Thermal shutdown
- Under voltage lock out
- Current fold back

### PRODUCT OVERVIEW

The NCS12 series of DC/DC converters offers single & dual output voltages from input voltage ranges of 9-36V and 18-75V. The NCS12 is housed in an industry standard package with a standard pinout. The NCS12 is packaged in a metal case for improved EMI shielding and is also encapsulated for superior thermal performance.

Applications include telecommunications, battery powered systems, process control and distributed power systems.

### SELECTION GUIDE

Order Code	Input Voltage	Output Voltage	Output Current	Load Regulation				Efficiency		MTTF <sup>1</sup>
				Positive Output	Negative Output	Positive Output	Negative Output	Min.	Typ.	
	Nom.	Typical		Max		%	%	Hrs		
	V	V	A	%	%	%	V	%		
NCS12S1203C	12	3.3	3.64	1		1.5		78	83.5	269,492
NCS12S1205C	12	5	2.40	0.5		1		84	88	313,578
NCS12S1212C	12	12	1.00	0.1		0.3		83	84.5	230,569
NCS12S1215C	12	15	0.80	0.1		0.3		83	85.5	195,596
NCS12S4803C	48	3.3	3.64	1.2		2		81	85.5	341,943
NCS12S4805C	48	5	2.40	0.5		1		84	87.5	418,117
NCS12S4812C	48	12	1.00	0.1		0.3		82	84.5	296,593
NCS12S4815C	48	15	0.80	0.1		0.3		84	85	259,485
NCS12D1205C	12	±5	±1.2	0.15	0.3	0.3	2	80	81.5	182,655
NCS12D1212C	12	±12	±0.5	0.05	0.2	0.3	1.5	83	85	158,750
NCS12D1215C	12	±15	±0.4	0.05	0.1	0.3	1.5	84	86	140,435
NCS12D4805C	48	±5	±1.2	0.15	0.5	0.3	2	78	80	165,931
NCS12D4812C	48	±12	±0.5	0.05	0.4	0.3	1.5	83	85	215,533
NCS12D4815C	48	±15	±0.4	0.05	0.4	0.3	1.5	83	85	146,257

### SELECTION GUIDE (Continued)

Order Code	Input Current			Ripple and Noise	
	10% Load	10% Load	100% Load	Typ.	Max
	Typ. 12/48V	Typ. 24V	Typ. 12/48V		
	A	A	A	mVp/p	mVp/p
NCS12S1203C	0.15	0.1	1.2	60	125
NCS12S1205C	0.1	0.16	1.1	50	125
NCS12S1212C	0.1	0.06	1.2	80	125
NCS12S1215C	0.06	0.1	1.2	100	125
NCS12S4803C	0.05	0.08	0.3	100	125
NCS12S4805C	0.05	0.08	0.3	90	125
NCS12S4812C	0.03	0.06	0.3	75	125
NCS12S4815C	0.03	0.06	0.3	90	125
NCS12D1205C	0.04	0.07	1.25	35	100
NCS12D1212C	0.04	0.07	1.2	40	100
NCS12D1215C	0.05	0.07	1.5	55	100
NCS12D4805C	0.03	0.07	0.3	70	100
NCS12D4812C	0.03	0.07	0.3	84	100
NCS12D4815C	0.03	0.07	0.4	55	100

### INPUT CHARACTERISTICS

Parameter	Conditions	Min.	Typ.	Max.	Units
Voltage range	12V input types	9	24	36	V
	48V input types	18	48	75	
Under voltage lock out	Turn on threshold 12V input types		8.5		V
	Turn off threshold 12V input types		7.5		
	Turn on threshold 48V input types		16.7		
	Turn off threshold 48V input types		15.8		
Power consumption at shutdown	NCS12X12		10		mW
	NCS12X48		100		
Reflected ripple current	48V dual output types		15		mA p-p
	All other types		10		

<sup>1</sup> Calculated using MIL-HDBK-217 FN2, parts stress method with nominal input voltage at full load.

All specifications typical at TA=25°C, nominal input voltage and rated output current unless otherwise specified.



### OUTPUT CHARACTERISTICS

Parameter	Conditions	Min.	Typ.	Max.	Units
Rated power	All output types			12	W
Minimal load to meet datasheet specification		10			%
Voltage set point accuracy	Positive outputs			±2	%
	Negative outputs			±3	
Line regulation	Low line to high line	Positive outputs	0.04	0.1	%
		Negative outputs	0.3	1	
Cross Regulation	D1205 & D4805		±4	±6.5	%
	D1212, D1215, D4812, D4815		±2	±5	
Transient response	Peak deviation (12.5-37.5% & 37.5-12.5% swing)			5	%V <sub>out</sub>
	Settling time (within 1% V <sub>out</sub> Nom.)	Single output types	500		µs
Dual output types		250			

### ISOLATION CHARACTERISTICS

Parameter	Conditions	Min.	Typ.	Max.	Units
Isolation test voltage	Flash tested for 1 seconds	1500			VDC
Resistance	Viso = 1kVDC	1			GΩ
Capacitance	S1203, S1205, S4803, S4805		600		pF
	All other types		230		

### ABSOLUTE MAXIMUM RATINGS

Short-circuit protection (for SELV input voltages)	30 minutes
Control pin input voltage	18V Max
Lead temperature 1.0mm from case for 10 seconds (to JEDEC JESD22-B106 ISS C)	260°C
Input voltage, NCS12 12V input types	40V
Input voltage, NCS12 48V input types	80V

### GENERAL CHARACTERISTICS<sup>1</sup>

Parameter	Conditions	Min.	Typ.	Max.	Units
Switching frequency	S1203, S1205, S4803 & S4805		340		kHz
	All other types		220		
Control pin input	Module on, pin unconnected or open collector floating				V
	Module off			0.8	

### TEMPERATURE CHARACTERISTICS

Parameter	Conditions	Min.	Typ.	Max.	Units
Operation	With derating - see derating graph	-40		85	°C
Storage		-50		125	
Case temperature above ambient	100% Load, Nom V <sub>IN</sub> , Still Air	NCS12S1203C		65	
		NCS12S1215C, NCS12D1205C, NCS12D4805C		60	
		All other types		44	
Thermal shutdown	Case Temperature	Single 3.3V & 5V outputs		135	
		All other types		120	

## APPLICATION NOTES

### Output Capacitance and start-up times

The NCS12 series does not require output capacitors to meet datasheet specification. To meet datasheet specification, total output capacitance should not exceed:

Part No.	Maximun Load Capacitance (per output)	Start-up times
	µF	ms
NCS12S1203C	470	16
NCS12S1205C	470	22
NCS12S1212C	220	7
NCS12S1215C	220	8.5
NCS12S4803C	470	14
NCS12S4805C	470	22
NCS12S4812C	220	8
NCS12S4815C	220	8.5
NCS12D1205C	220	5
NCS12D1212C	100	8
NCS12D1215C	100	9
NCS12D4805C	220	5
NCS12D4812C	100	7.5
NCS12D4815C	100	7

## TECHNICAL NOTES

### ISOLATION VOLTAGE

'Hi Pot Test', 'Flash Tested', 'Withstand Voltage', 'Proof Voltage', 'Dielectric Withstand Voltage' & 'Isolation Test Voltage' are all terms that relate to the same thing, a test voltage, applied for a specific time, across a component designed to provide electrical isolation, to verify the integrity of that isolation.

Murata Power Solutions NCS12 series of DC/DC converters are all 100% production tested at their stated isolation voltage. This is 1.5kVDC for 1 second.

A question commonly asked is, "What is the continuous voltage that can be applied across the part in normal operation?"

For a part holding no specific agency approvals, such as the NCS12 series, both input and output should normally be maintained within SELV limits i.e. less than 42.4V peak, or 60VDC. The isolation test voltage represents a measure of immunity to transient voltages and the part should never be used as an element of a safety isolation system. The part could be expected to function correctly with several hundred volts offset applied continuously across the isolation barrier; but then the circuitry on both sides of the barrier must be regarded as operating at an unsafe voltage and further isolation/insulation systems must form a barrier between these circuits and any user-accessible circuitry according to safety standard requirements.

### REPEATED HIGH-VOLTAGE ISOLATION TESTING

It is well known that repeated high-voltage isolation testing of a barrier component can actually degrade isolation capability, to a lesser or greater degree depending on materials, construction and environment. The NCS12 series has an ER ferrite core, with no additional insulation between primary and secondary windings of enameled wire. While parts can be expected to withstand several times the stated test voltage, the isolation capability does depend on the wire insulation. Any material, including this enamel (typically polyurethane) is susceptible to eventual chemical degradation when subject to very high applied voltages thus implying that the number of tests should be strictly limited. We therefore strongly advise against repeated high voltage isolation testing, but if it is absolutely required, that the voltage be reduced by 20% from specified test voltage.

This consideration equally applies to agency recognized parts rated for better than functional isolation where the wire enamel insulation is always supplemented by a further insulation system of physical spacing or barriers.

## RoHS COMPLIANCE INFORMATION



This series is compatible with RoHS soldering systems with a peak wave solder temperature of 260°C for 10 seconds. The pin termination finish on this product series is a Gold flash (0.05-0.10 micron) over Nickel Preplate. The series is backward compatible with Sn/Pb soldering systems. For further information, please visit [www.murata-ps.com/rohs](http://www.murata-ps.com/rohs)

**CHARACTERISATION TEST METHODS**

**Ripple & Noise Characterisation Method**

Ripple and noise measurements are performed with the following test configuration.

C1	1µF X7R multilayer ceramic capacitor, voltage rating to be a minimum of 3 times the output voltage of the DC/DC converter
C2	10µF tantalum capacitor, voltage rating to be a minimum of 1.5 times the output voltage of the DC/DC converter with an ESR of less than 100mΩ at 100 kHz
C3	100nF multilayer ceramic capacitor, general purpose
R1	450Ω resistor, carbon film, ±1% tolerance
R2	50Ω BNC termination
T1	3T of the coax cable through a ferrite toroid
RLOAD	Resistive load to the maximum power rating of the DC/DC converter. Connections should be made via twisted wires
Measured values are multiplied by 10 to obtain the specified values.	

**Differential Mode Noise Test Schematic**

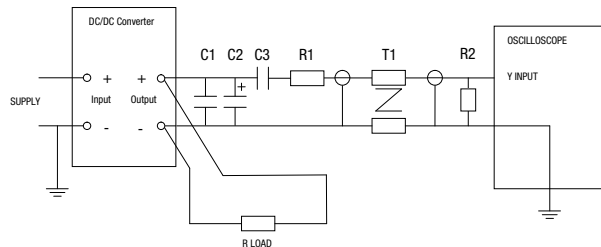

**EFFICIENCY VS LOAD**

**NCS12S1203C**

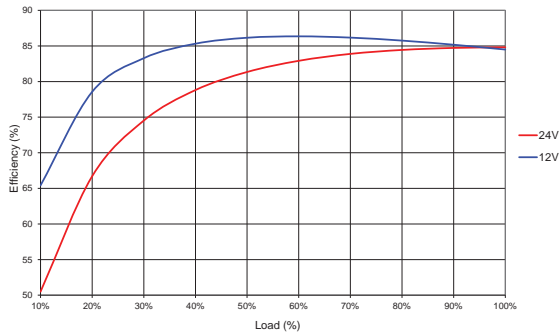

**NCS12S1205C**

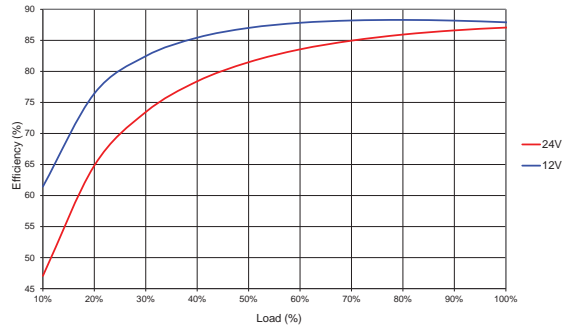

**NCS12S1212C**

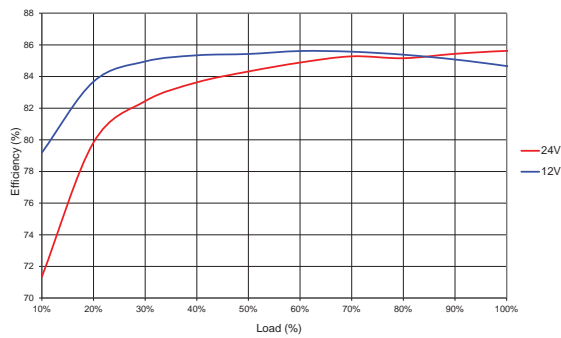

**NCS12S1215C**

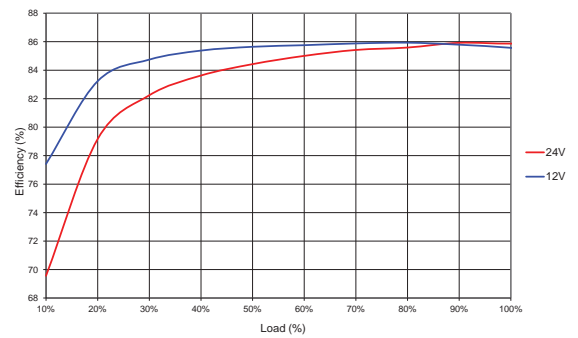

**NCS12S4803C**

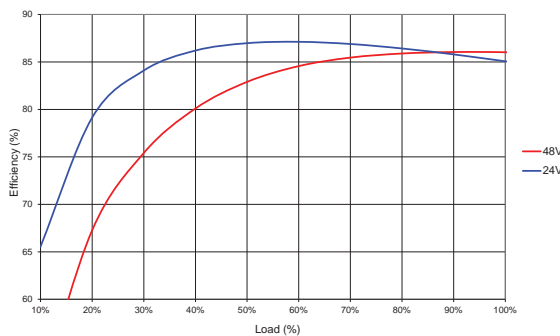

**NCS12S4805C**

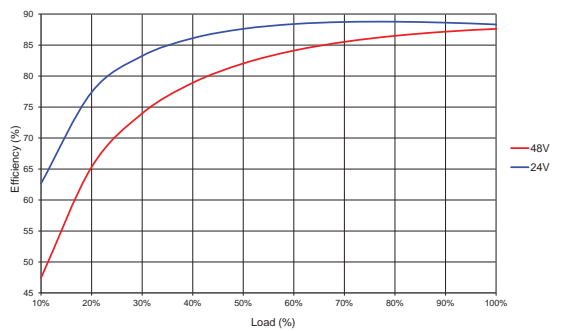

**NCS12S4812C**

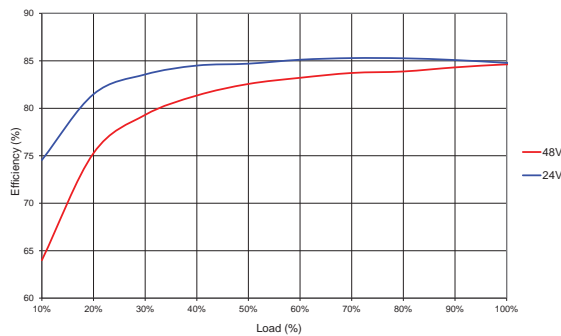

**NCS12S4815C**

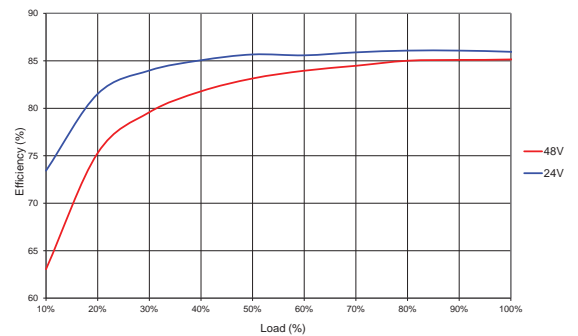

## EFFICIENCY VS LOAD

**NCS12D1205C**

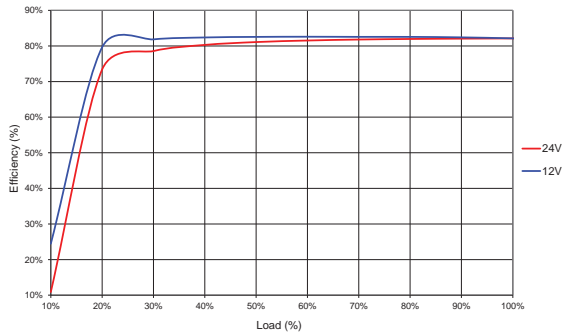

**NCS12D1212C**

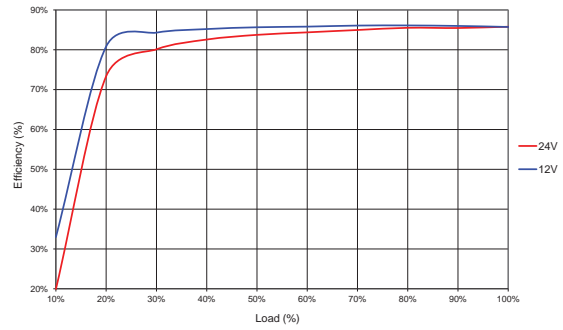

**NCS12D1215C**

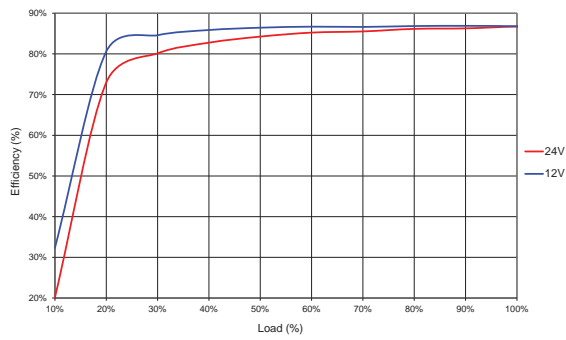

**NCS12D4805C**

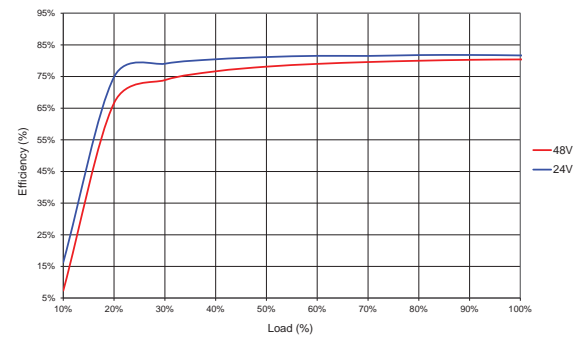

**NCS12D4812C**

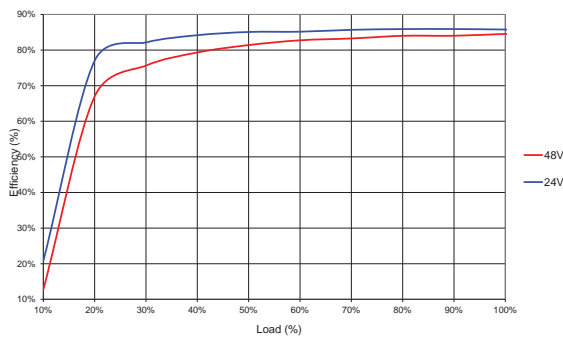

**NCS12D4815C**

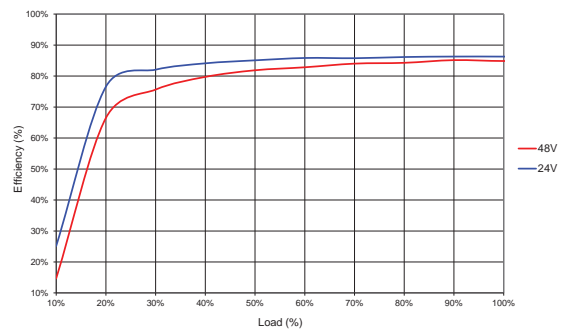

## TEMPERATURE DERATING

### NCS12S1203C

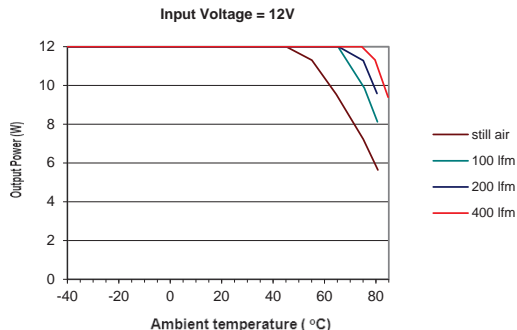
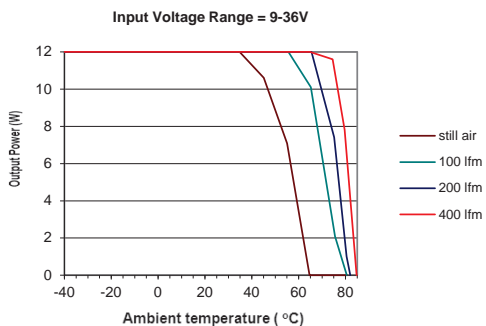

### NCS12S1205C

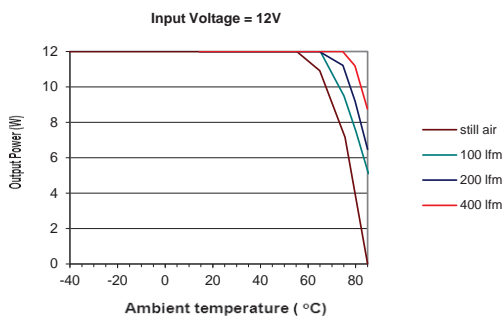
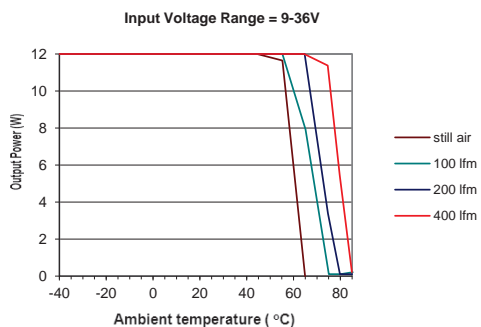

### NCS12S1212C

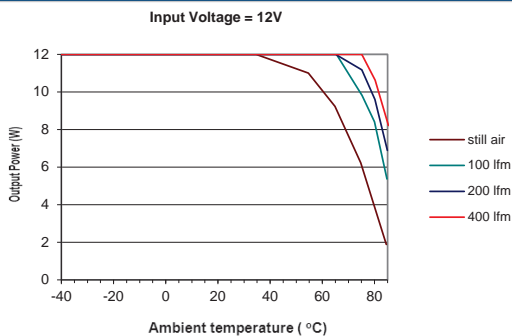
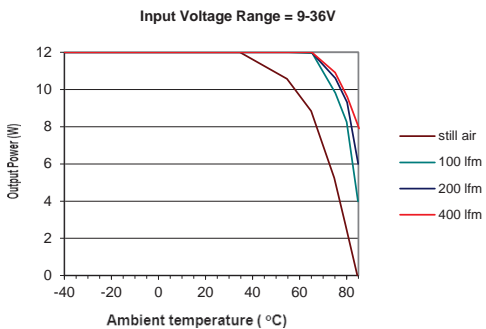

### NCS12S1215C

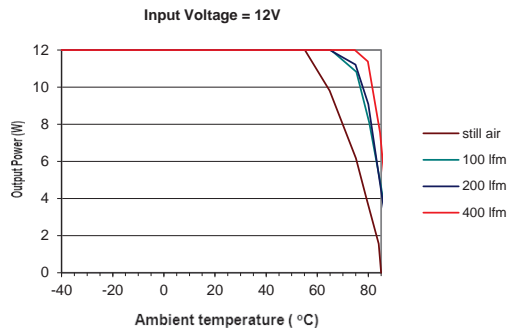
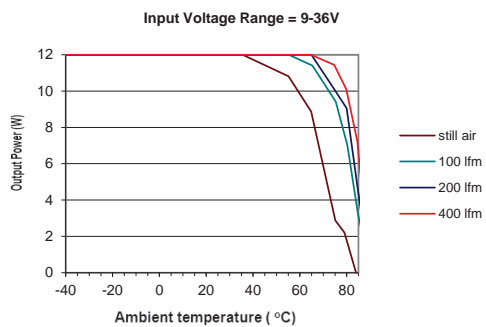

**TEMPERATURE DERATING**

**NCS12S4803C**

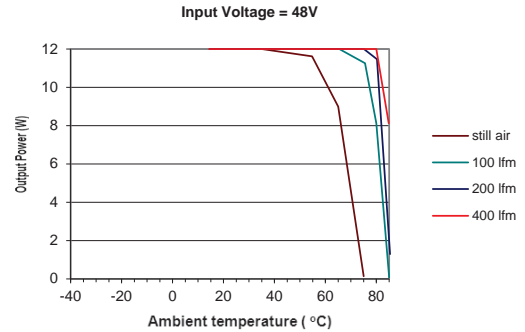
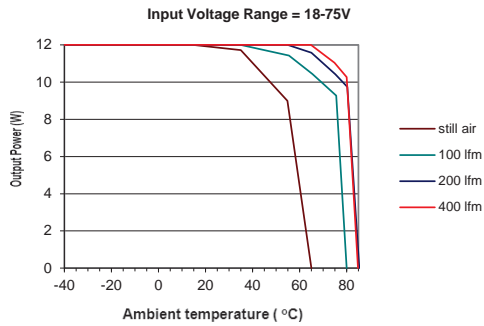

**NCS12S4805C**

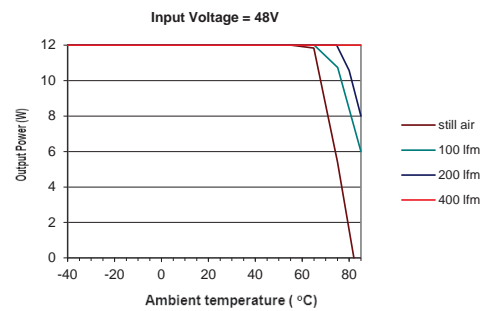
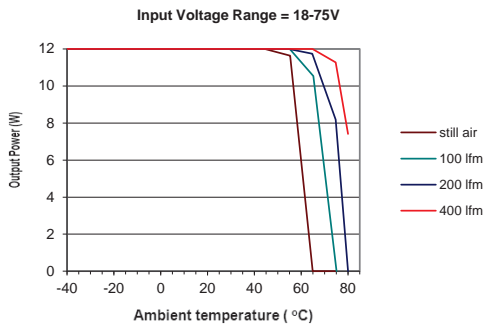

**NCS12S4812C**

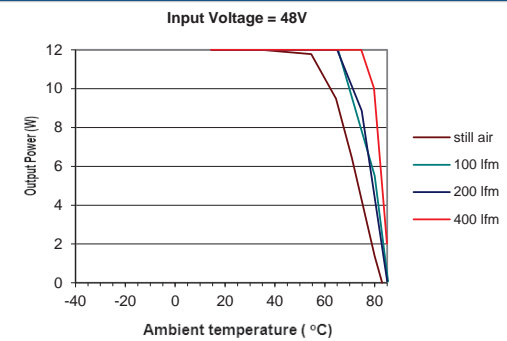
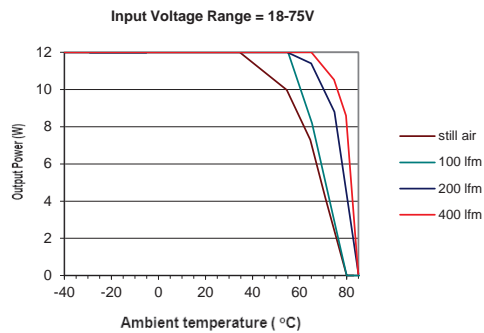

**NCS12S4815C**

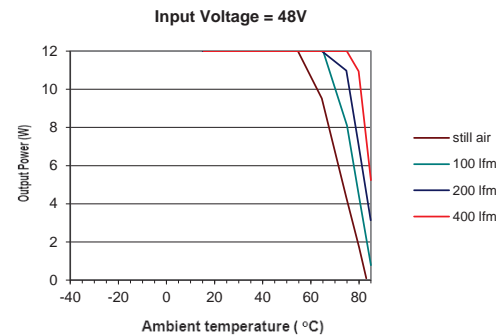
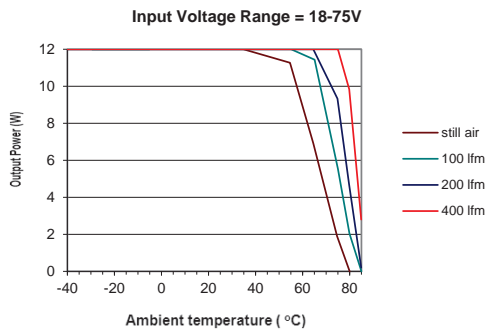



**TEMPERATURE DERATING**

**NCS12D1205C**

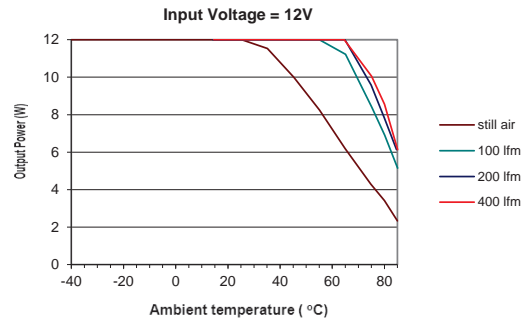
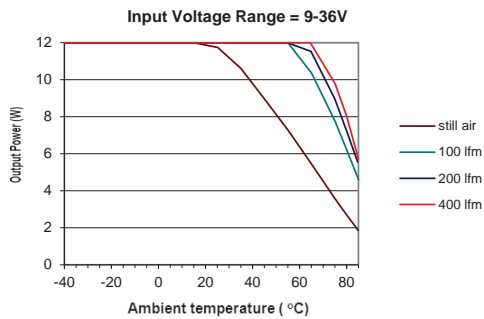

**NCS12D1212C**

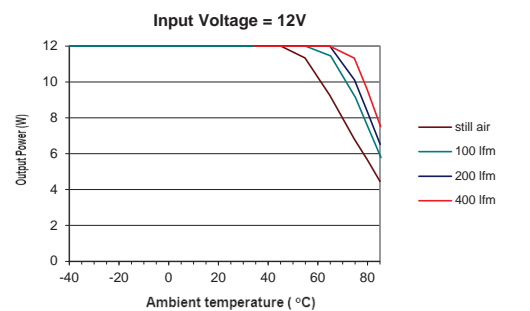
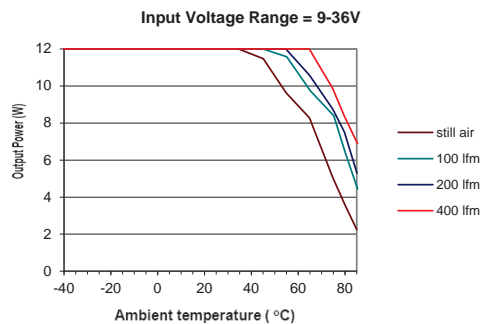

**NCS12D1215C**

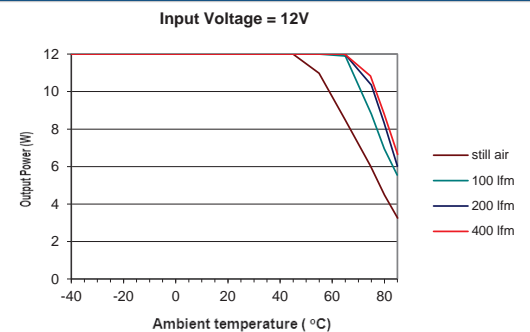
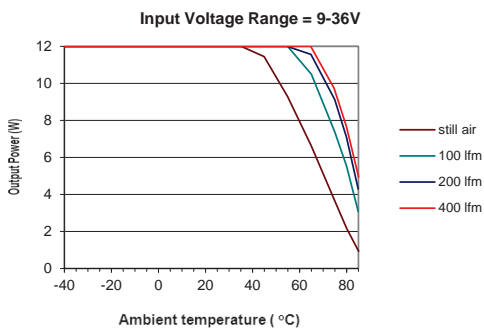

**NCS12D4805C**

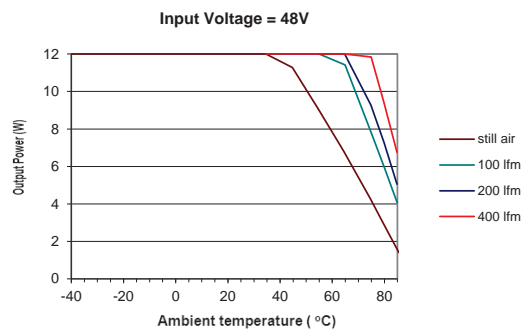
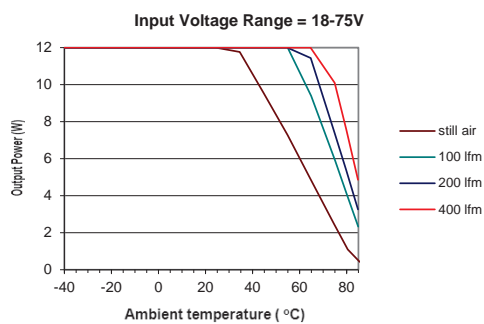

## TEMPERATURE DERATING

### NCS12D4812C

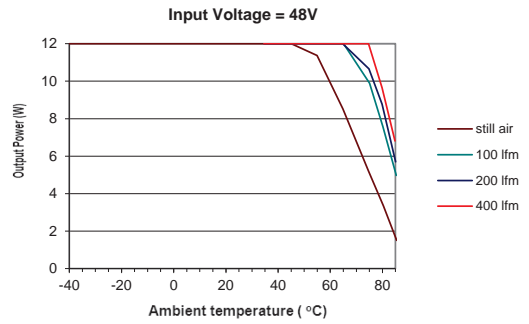
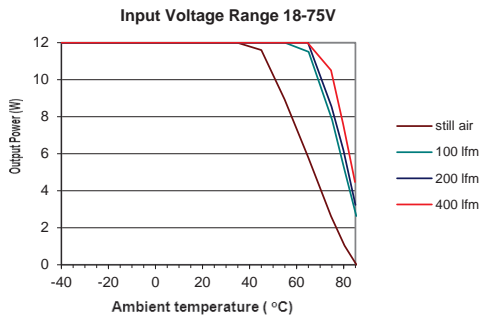

### NCS12D4815C

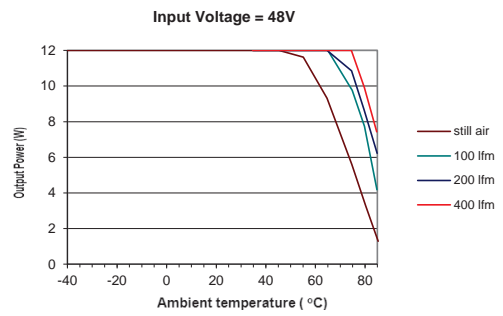
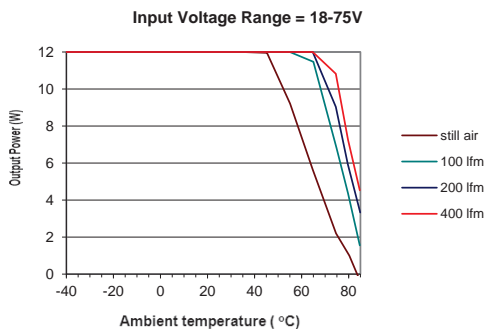

**EMC FILTERING AND SPECTRA**

**FILTERING**

The module includes a basic level of filtering, sufficient for many applications. Where lower noise levels are desired, filters can easily be added to achieve any required noise performance.

A DC/DC converter generates noise in two principle forms: that which is radiated from its body and that conducted on its external connections. There are three separate modes of conducted noise: input differential, output differential and input-output.

This last appears as common mode at the input and the output, and cannot therefore be removed by filtering at the input or output alone. The first level of filtering is to connect capacitors between input and output returns, to reduce this form of noise. It typically contains high harmonics of the switching frequency, which tend to appear as spikes on surrounding circuits. The voltage rating of this capacitor must match the required isolation voltage. (Due to the great variety in isolation voltage and required noise performance, this capacitor has not been included within the converter.)

Input ripple is a voltage developed across the internal Input decoupling capacitor. It is therefore measured with a defined supply source impedance. Although simple series inductance will provide filtering, on its own it can degrade the stability. A shunt capacitor is therefore recommended across the converter input terminals, so that it is fed from a low impedance.

If no filtering is required, the inductance of long supply wiring could also cause a problem, requiring an input decoupling capacitor for stability. An electrolytic will perform well in these situations. The input-output filtering is performed by the common-mode choke on the primary. This could be placed on the output, but would then degrade the regulation and produce less benefit for a given size, cost, and power loss.

Radiated noise is present in magnetic and electrostatic forms. The latter is suppressed by the metal case, which is connected to the output return, typically a zero-volt point. Thanks to the small size of these units, neither form of noise will be radiated "efficiently", so will not normally cause a problem. Any question of this kind usually better repays attention to conducted signals.

**EMC FILTER AND VALUES TO OBTAIN SPECTRA AS SHOWN**

The following filter circuit shows the input filter typically required to meet CISPR22 Quasi-Peak Curve B.

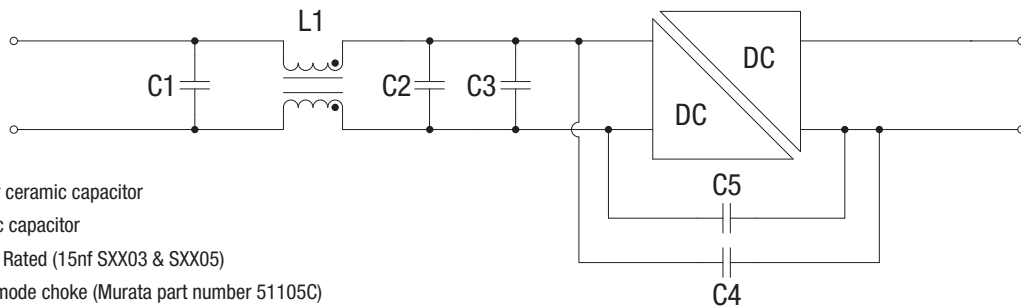

- C1, C2** 1µF Polyester or ceramic capacitor
- C3** 47µF Electrolytic capacitor
- C4 & C5** 10nF 250 VAC Y Rated (15nf SXX03 & SXX05)
- L1** 1mH Common-mode choke (Murata part number 51105C)

**EMC FILTERING AND SPECTRA**

**NCS12S1203C**

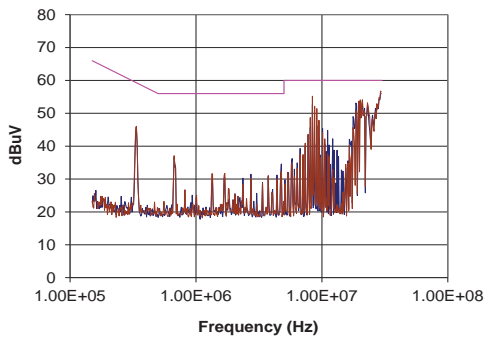

**NCS12S1205C**

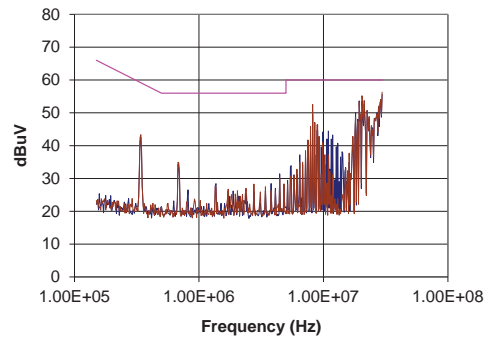

**NCS12S1212C**

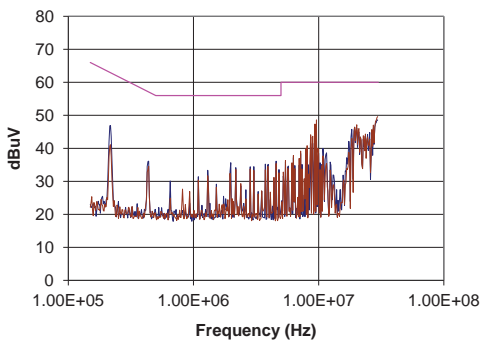

**NCS12S1215C**

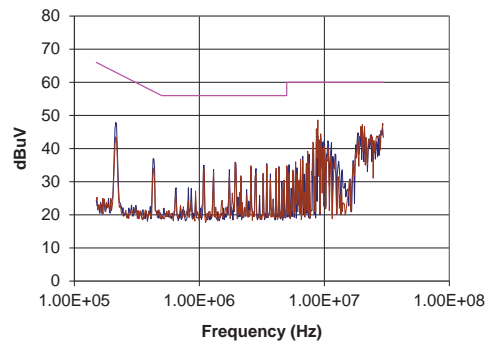

**NCS12S4803C**

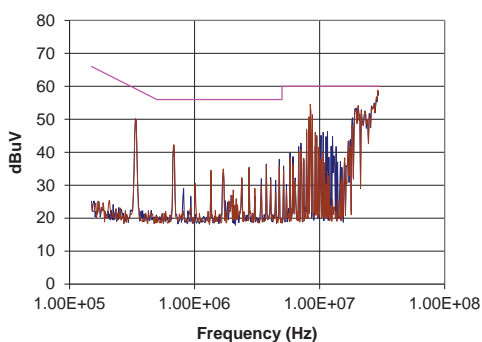

**NCS12S4805C**

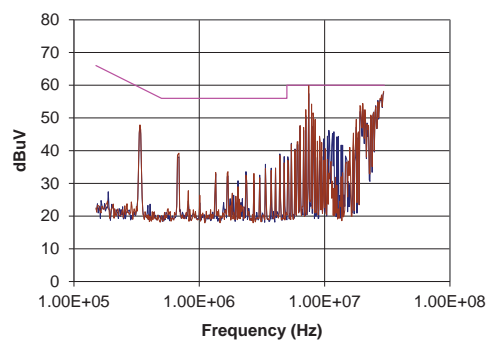

**NCS12S4812C**

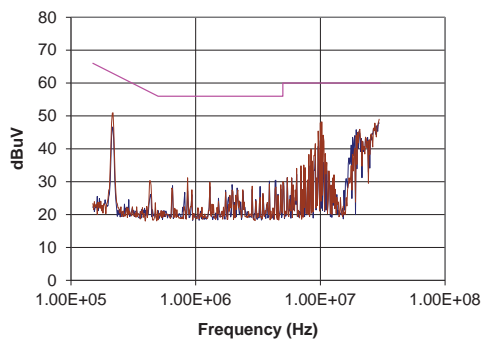

**NCS12S4815C**

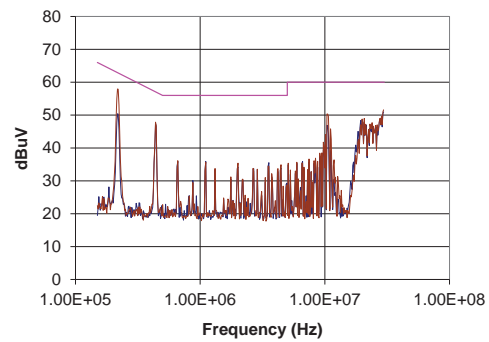

**EMC FILTERING AND SPECTRA**

**NCS12D1205C**

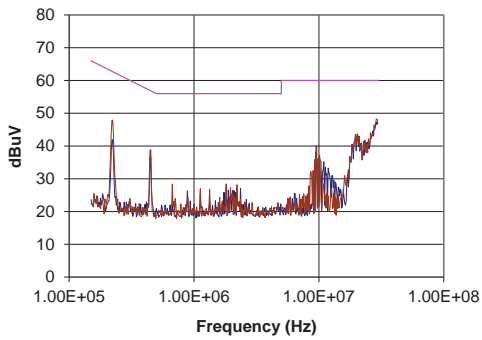

**NCS12D1212C**

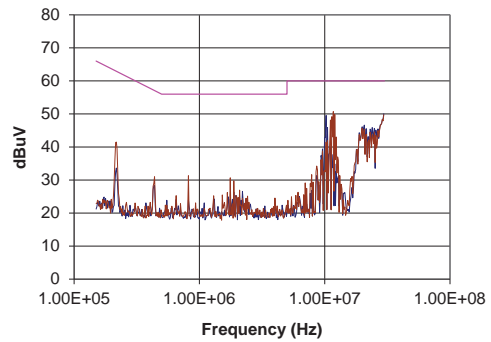

**NCS12D1215C**

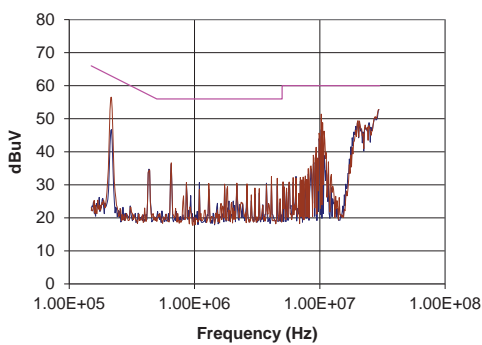

**NCS12D4805C**

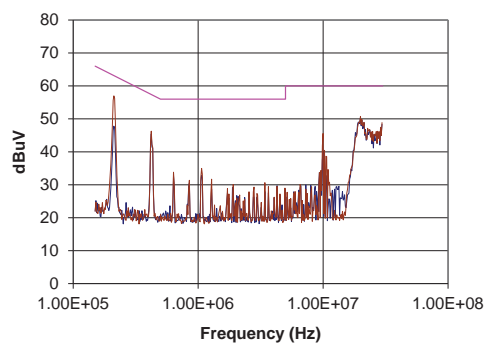

**NCS12D4812C**

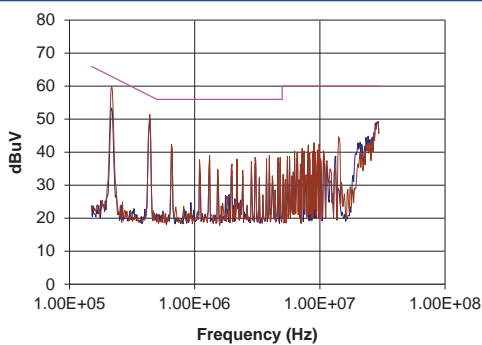

**NCS12D4815C**

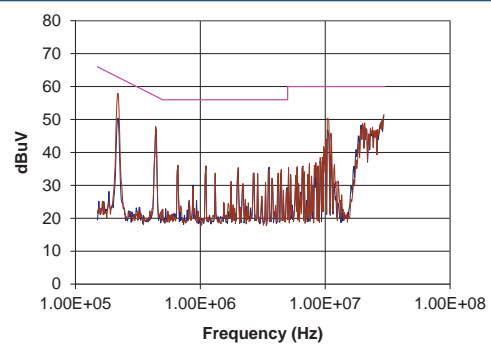

**PACKAGE SPECIFICATIONS**

**MECHANICAL DIMENSIONS**

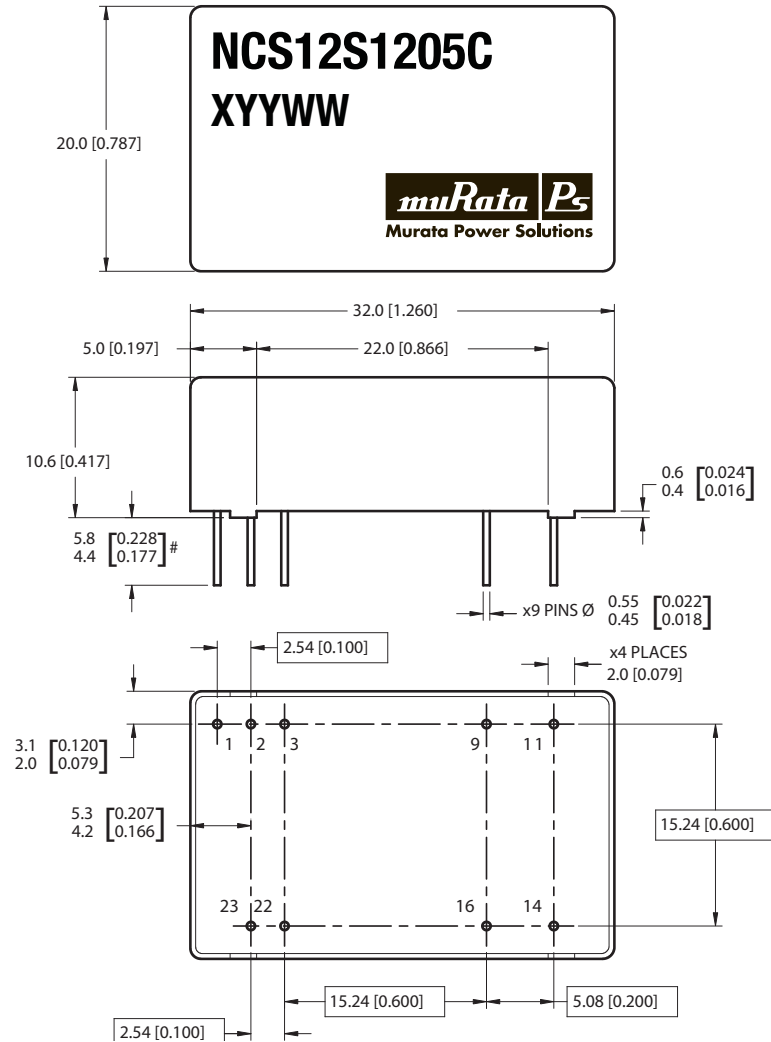

# The pin length of the following variants is 4.2-5.3 (0.165-0.209) ; NCS12Sxx03C & NCS12Sxx05SC

All dimensions in mm (inches)  
Tolerances (unless otherwise stated) ±0.4 (0.016).  
All pins on a 2.54(0.100) pitch and within 0.25(0.010) of true position.

Weight: 17g

**PIN CONNECTIONS**

Pin	Function	
	Single	Dual
1	Control	Control
2	-VIN	-VIN
3	-VIN	-VIN
9	No pin	0V
11	N/C	-VOUT
14	+VOUT	+VOUT
16	0V	0V
22	+VIN	+VIN
23	+VIN	+VIN

**TUBE OUTLINE DIMENSIONS**

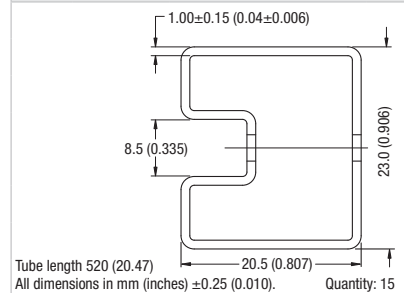

**RECOMMENDED FOOTPRINT DETAILS**

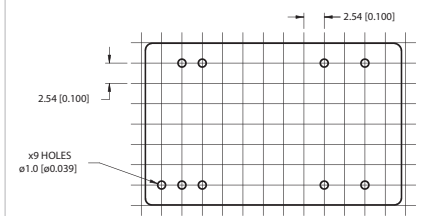

All dimensions in mm (inches) ±0.25 (± 0.010).

Murata Power Solutions, Inc.  
11 Cabot Boulevard, Mansfield, MA 02048-1151 U.S.A.  
ISO 9001 and 14001 REGISTERED



This product is subject to the following **operating requirements** and the **Life and Safety Critical Application Sales Policy**:  
Refer to: <http://www.murata-ps.com/requirements/>

Murata Power Solutions, Inc. makes no representation that the use of its products in the circuits described herein, or the use of other technical information contained herein, will not infringe upon existing or future patent rights. The descriptions contained herein do not imply the granting of licenses to make, use, or sell equipment constructed in accordance therewith. Specifications are subject to change without notice. © 2016 Murata Power Solutions, Inc.