

FEATURES

- UL 60950 recognition pending
- 4:1 Wide range voltage input
- Operating temperature range -40°C to 85°C
- Typical load regulation from 0.05%
- 1.5kVDC Isolation 'Hi Pot Test'
- 3.3V, 5V, 12V & 15V outputs
- UL 94V-0 Package materials
- No electrolytic capacitors
- Thermal shutdown
- Under voltage lock out
- Current fold back

PRODUCT OVERVIEW

The NCS12 series of DC/DC converters offers single & dual output voltages from input voltage ranges of 9-36V and 18-75V. The NCS12 is housed in an industry standard package with a standard pinout. The NCS12 is packaged in a metal case for improved EMI shielding and is also encapsulated for superior thermal performance.

Applications include telecommunications, battery powered systems, process control and distributed power systems.

SELECTION GUIDE

| Order Code | Input Voltage | Output Voltage | Output Current | Load Regulation | | | | Efficiency | | MTTF ¹ |
|-------------|---------------|----------------|----------------|-----------------|-----------------|-----------------|-----------------|------------|------|-------------------|
| | | | | Positive Output | Negative Output | Positive Output | Negative Output | Min. | Typ. | |
| | Nom. | Typical | | Max | | % | % | Hrs | | |
| | V | V | A | % | % | % | V | % | | |
| NCS12S1203C | 12 | 3.3 | 3.64 | 1 | | 1.5 | | 78 | 83.5 | 269,492 |
| NCS12S1205C | 12 | 5 | 2.40 | 0.5 | | 1 | | 84 | 88 | 313,578 |
| NCS12S1212C | 12 | 12 | 1.00 | 0.1 | | 0.3 | | 83 | 84.5 | 230,569 |
| NCS12S1215C | 12 | 15 | 0.80 | 0.1 | | 0.3 | | 83 | 85.5 | 195,596 |
| NCS12S4803C | 48 | 3.3 | 3.64 | 1.2 | | 2 | | 81 | 85.5 | 341,943 |
| NCS12S4805C | 48 | 5 | 2.40 | 0.5 | | 1 | | 84 | 87.5 | 418,117 |
| NCS12S4812C | 48 | 12 | 1.00 | 0.1 | | 0.3 | | 82 | 84.5 | 296,593 |
| NCS12S4815C | 48 | 15 | 0.80 | 0.1 | | 0.3 | | 84 | 85 | 259,485 |
| NCS12D1205C | 12 | ±5 | ±1.2 | 0.15 | 0.3 | 0.3 | 2 | 80 | 81.5 | 182,655 |
| NCS12D1212C | 12 | ±12 | ±0.5 | 0.05 | 0.2 | 0.3 | 1.5 | 83 | 85 | 158,750 |
| NCS12D1215C | 12 | ±15 | ±0.4 | 0.05 | 0.1 | 0.3 | 1.5 | 84 | 86 | 140,435 |
| NCS12D4805C | 48 | ±5 | ±1.2 | 0.15 | 0.5 | 0.3 | 2 | 78 | 80 | 165,931 |
| NCS12D4812C | 48 | ±12 | ±0.5 | 0.05 | 0.4 | 0.3 | 1.5 | 83 | 85 | 215,533 |
| NCS12D4815C | 48 | ±15 | ±0.4 | 0.05 | 0.4 | 0.3 | 1.5 | 83 | 85 | 146,257 |

SELECTION GUIDE (Continued)

| Order Code | Input Current | | | Ripple and Noise | |
|-------------|---------------|----------|-------------|------------------|-----|
| | 10% Load | 10% Load | 100% Load | Typ. | Max |
| | Typ. 12/48V | Typ. 24V | Typ. 12/48V | | |
| A | A | A | mVp/p | mVp/p | |
| NCS12S1203C | 0.15 | 0.1 | 1.2 | 60 | 125 |
| NCS12S1205C | 0.1 | 0.16 | 1.1 | 50 | 125 |
| NCS12S1212C | 0.1 | 0.06 | 1.2 | 80 | 125 |
| NCS12S1215C | 0.06 | 0.1 | 1.2 | 100 | 125 |
| NCS12S4803C | 0.05 | 0.08 | 0.3 | 100 | 125 |
| NCS12S4805C | 0.05 | 0.08 | 0.3 | 90 | 125 |
| NCS12S4812C | 0.03 | 0.06 | 0.3 | 75 | 125 |
| NCS12S4815C | 0.03 | 0.06 | 0.3 | 90 | 125 |
| NCS12D1205C | 0.04 | 0.07 | 1.25 | 35 | 100 |
| NCS12D1212C | 0.04 | 0.07 | 1.2 | 40 | 100 |
| NCS12D1215C | 0.05 | 0.07 | 1.5 | 55 | 100 |
| NCS12D4805C | 0.03 | 0.07 | 0.3 | 70 | 100 |
| NCS12D4812C | 0.03 | 0.07 | 0.3 | 84 | 100 |
| NCS12D4815C | 0.03 | 0.07 | 0.4 | 55 | 100 |

INPUT CHARACTERISTICS

| Parameter | Conditions | Min. | Typ. | Max. | Units |
|-------------------------------|------------------------------------|------|------|------|--------|
| Voltage range | 12V input types | 9 | 24 | 36 | V |
| | 48V input types | 18 | 48 | 75 | |
| Under voltage lock out | Turn on threshold 12V input types | | 8.5 | | V |
| | Turn off threshold 12V input types | | 7.5 | | |
| | Turn on threshold 48V input types | | 16.7 | | |
| | Turn off threshold 48V input types | | 15.8 | | |
| Power consumption at shutdown | NCS12X12 | | 10 | | mW |
| | NCS12X48 | | 100 | | |
| Reflected ripple current | 48V dual output types | | 15 | | mA p-p |
| | All other types | | 10 | | |

¹ Calculated using MIL-HDBK-217 FN2, parts stress method with nominal input voltage at full load.

All specifications typical at TA=25°C, nominal input voltage and rated output current unless otherwise specified.



OUTPUT CHARACTERISTICS

| Parameter | Conditions | Min. | Typ. | Max. | Units |
|--|--|---------------------|------|------|-------------------|
| Rated power | All output types | | | 12 | W |
| Minimal load to meet datasheet specification | | 10 | | | % |
| Voltage set point accuracy | Positive outputs | | | ±2 | % |
| | Negative outputs | | | ±3 | |
| Line regulation | Low line to high line | Positive outputs | 0.04 | 0.1 | % |
| | | Negative outputs | 0.3 | 1 | |
| Cross Regulation | D1205 & D4805 | | ±4 | ±6.5 | % |
| | D1212, D1215, D4812, D4815 | | ±2 | ±5 | |
| Transient response | Peak deviation (12.5-37.5% & 37.5-12.5% swing) | | | 5 | %V _{out} |
| | Settling time (within 1% V _{out} Nom.) | Single output types | 500 | | µs |
| Dual output types | | 250 | | | |

ISOLATION CHARACTERISTICS

| Parameter | Conditions | Min. | Typ. | Max. | Units |
|------------------------|----------------------------|------|------|------|-------|
| Isolation test voltage | Flash tested for 1 seconds | 1500 | | | VDC |
| Resistance | Viso = 1kVDC | 1 | | | GΩ |
| Capacitance | S1203, S1205, S4803, S4805 | | 600 | | pF |
| | All other types | | 230 | | |

ABSOLUTE MAXIMUM RATINGS

| | |
|--|------------|
| Short-circuit protection (for SELV input voltages) | 30 minutes |
| Control pin input voltage | 18V Max |
| Lead temperature 1.0mm from case for 10 seconds (to JEDEC JESD22-B106 ISS C) | 260°C |
| Input voltage, NCS12 12V input types | 40V |
| Input voltage, NCS12 48V input types | 80V |

GENERAL CHARACTERISTICS¹

| Parameter | Conditions | Min. | Typ. | Max. | Units |
|---------------------|---|------|------|------|-------|
| Switching frequency | S1203, S1205, S4803 & S4805 | | 340 | | kHz |
| | All other types | | 220 | | |
| Control pin input | Module on, pin unconnected or open collector floating | | | | V |
| | Module off | | | 0.8 | |

TEMPERATURE CHARACTERISTICS

| Parameter | Conditions | Min. | Typ. | Max. | Units |
|--------------------------------|--|---------------------------------------|------|------|-------|
| Operation | With derating - see derating graph | -40 | | 85 | °C |
| Storage | | -50 | | 125 | |
| Case temperature above ambient | 100% Load, Nom V _{IN} , Still Air | NCS12S1203C | 65 | | |
| | | NCS12S1215C, NCS12D1205C, NCS12D4805C | 60 | | |
| | | All other types | 44 | | |
| Thermal shutdown | Case Temperature | Single 3.3V & 5V outputs | 135 | | |
| | | All other types | 120 | | |

APPLICATION NOTES

Output Capacitance and start-up times

The NCS12 series does not require output capacitors to meet datasheet specification. To meet datasheet specification, total output capacitance should not exceed:

| Part No. | Maximun Load Capacitance (per output) | Start-up times |
|-------------|---------------------------------------|----------------|
| | µF | ms |
| NCS12S1203C | 470 | 16 |
| NCS12S1205C | 470 | 22 |
| NCS12S1212C | 220 | 7 |
| NCS12S1215C | 220 | 8.5 |
| NCS12S4803C | 470 | 14 |
| NCS12S4805C | 470 | 22 |
| NCS12S4812C | 220 | 8 |
| NCS12S4815C | 220 | 8.5 |
| NCS12D1205C | 220 | 5 |
| NCS12D1212C | 100 | 8 |
| NCS12D1215C | 100 | 9 |
| NCS12D4805C | 220 | 5 |
| NCS12D4812C | 100 | 7.5 |
| NCS12D4815C | 100 | 7 |

TECHNICAL NOTES

ISOLATION VOLTAGE

'Hi Pot Test', 'Flash Tested', 'Withstand Voltage', 'Proof Voltage', 'Dielectric Withstand Voltage' & 'Isolation Test Voltage' are all terms that relate to the same thing, a test voltage, applied for a specific time, across a component designed to provide electrical isolation, to verify the integrity of that isolation.

Murata Power Solutions NCS12 series of DC/DC converters are all 100% production tested at their stated isolation voltage. This is 1.5kVDC for 1 second.

A question commonly asked is, "What is the continuous voltage that can be applied across the part in normal operation?"

For a part holding no specific agency approvals, such as the NCS12 series, both input and output should normally be maintained within SELV limits i.e. less than 42.4V peak, or 60VDC. The isolation test voltage represents a measure of immunity to transient voltages and the part should never be used as an element of a safety isolation system. The part could be expected to function correctly with several hundred volts offset applied continuously across the isolation barrier; but then the circuitry on both sides of the barrier must be regarded as operating at an unsafe voltage and further isolation/insulation systems must form a barrier between these circuits and any user-accessible circuitry according to safety standard requirements.

REPEATED HIGH-VOLTAGE ISOLATION TESTING

It is well known that repeated high-voltage isolation testing of a barrier component can actually degrade isolation capability, to a lesser or greater degree depending on materials, construction and environment. The NCS12 series has an ER ferrite core, with no additional insulation between primary and secondary windings of enameled wire. While parts can be expected to withstand several times the stated test voltage, the isolation capability does depend on the wire insulation. Any material, including this enamel (typically polyurethane) is susceptible to eventual chemical degradation when subject to very high applied voltages thus implying that the number of tests should be strictly limited. We therefore strongly advise against repeated high voltage isolation testing, but if it is absolutely required, that the voltage be reduced by 20% from specified test voltage.

This consideration equally applies to agency recognized parts rated for better than functional isolation where the wire enamel insulation is always supplemented by a further insulation system of physical spacing or barriers.

RoHS COMPLIANCE INFORMATION



This series is compatible with RoHS soldering systems with a peak wave solder temperature of 260°C for 10 seconds. The pin termination finish on this product series is a Gold flash (0.05-0.10 micron) over Nickel Preplate. The series is backward compatible with Sn/Pb soldering systems. For further information, please visit www.murata-ps.com/rohs

CHARACTERISATION TEST METHODS

Ripple & Noise Characterisation Method

Ripple and noise measurements are performed with the following test configuration.

| | |
|--|--|
| C1 | 1µF X7R multilayer ceramic capacitor, voltage rating to be a minimum of 3 times the output voltage of the DC/DC converter |
| C2 | 10µF tantalum capacitor, voltage rating to be a minimum of 1.5 times the output voltage of the DC/DC converter with an ESR of less than 100mΩ at 100 kHz |
| C3 | 100nF multilayer ceramic capacitor, general purpose |
| R1 | 450Ω resistor, carbon film, ±1% tolerance |
| R2 | 50Ω BNC termination |
| T1 | 3T of the coax cable through a ferrite toroid |
| RLOAD | Resistive load to the maximum power rating of the DC/DC converter. Connections should be made via twisted wires |
| Measured values are multiplied by 10 to obtain the specified values. | |

Differential Mode Noise Test Schematic

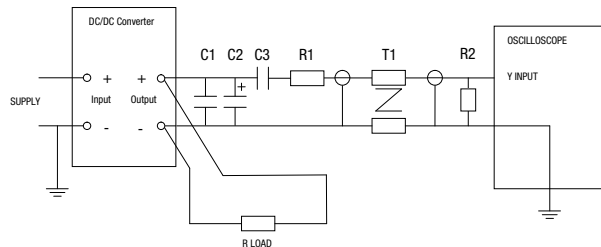

EFFICIENCY VS LOAD

NCS12S1203C

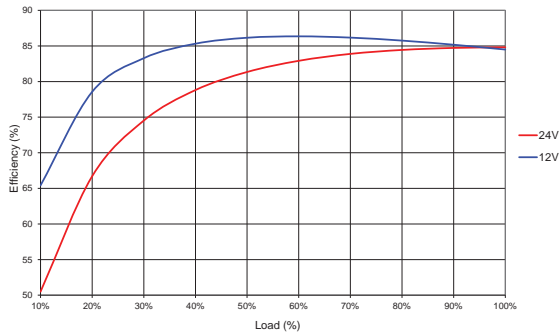

NCS12S1205C

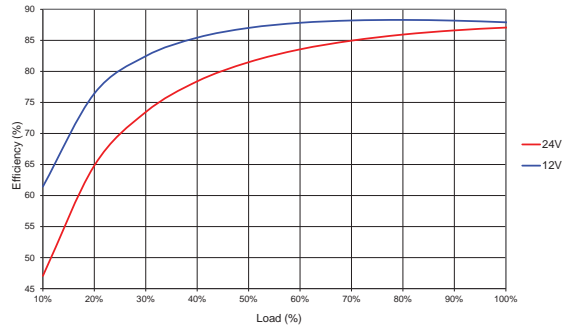

NCS12S1212C

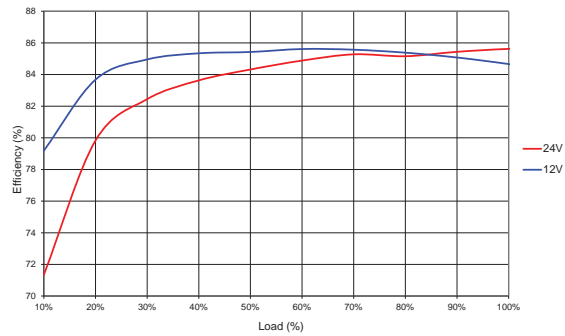

NCS12S1215C

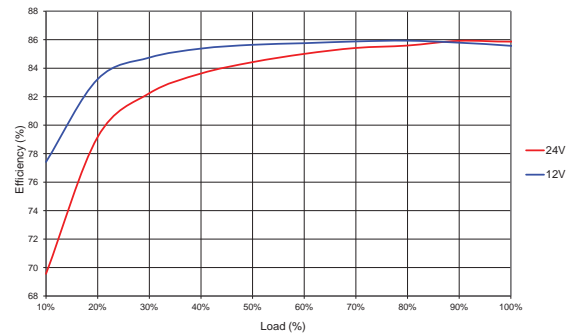

NCS12S4803C

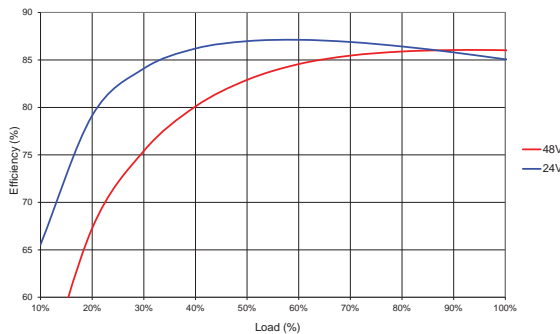

NCS12S4805C

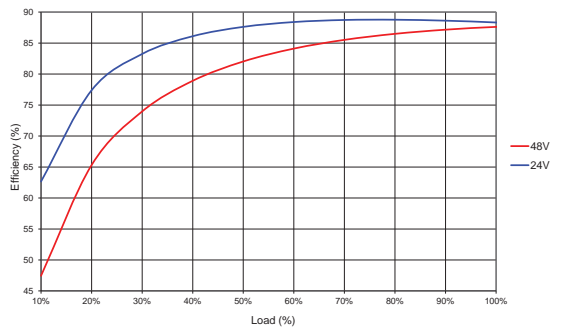

NCS12S4812C

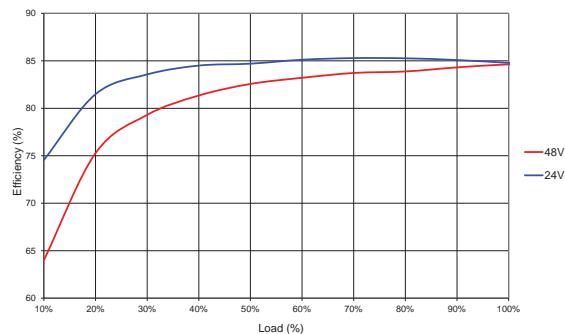

NCS12S4815C

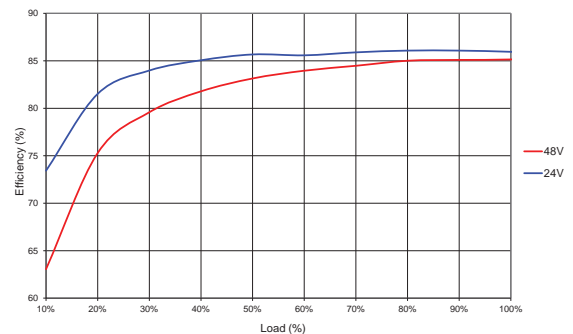

EFFICIENCY VS LOAD

NCS12D1205C

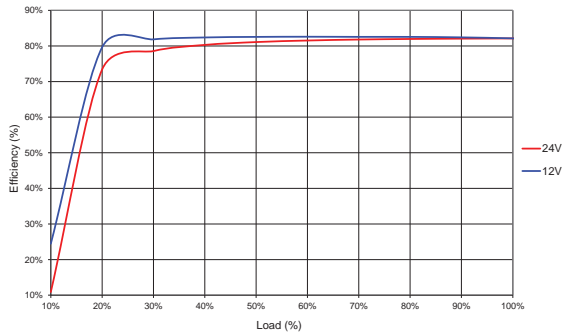

NCS12D1212C

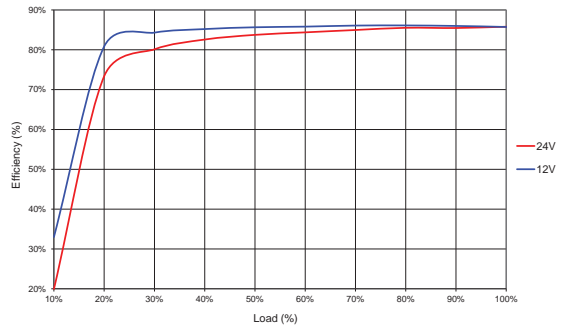

NCS12D1215C

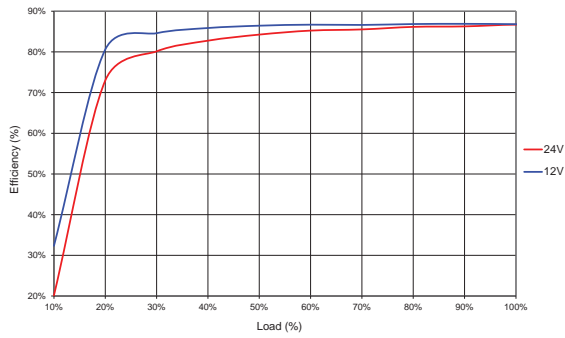

NCS12D4805C

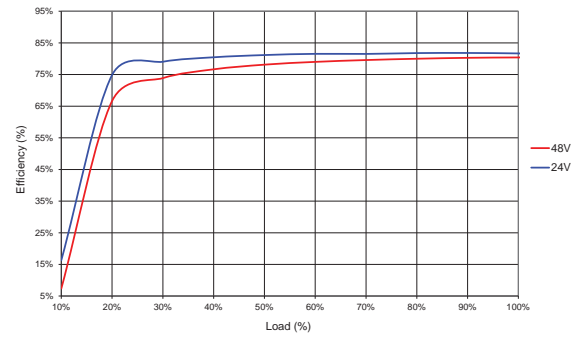

NCS12D4812C

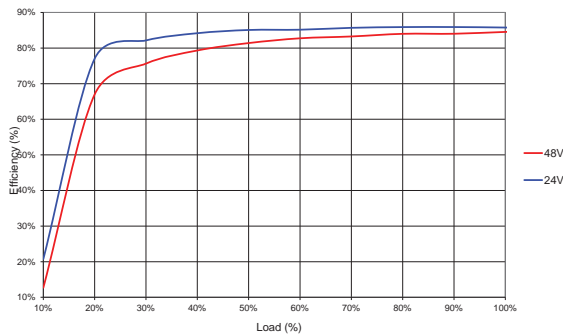

NCS12D4815C

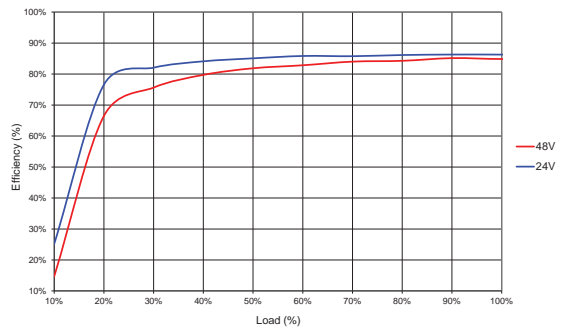

TEMPERATURE DERATING

NCS12S1203C

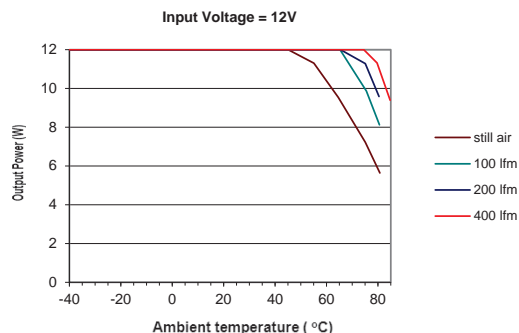
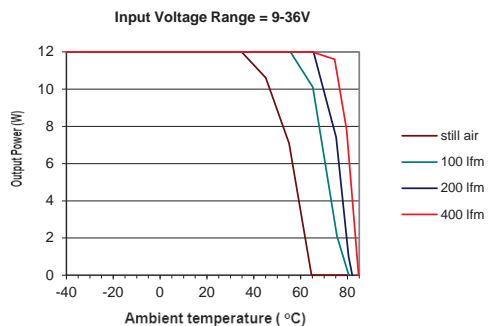

NCS12S1205C

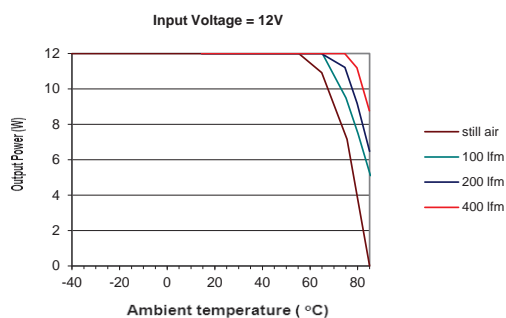
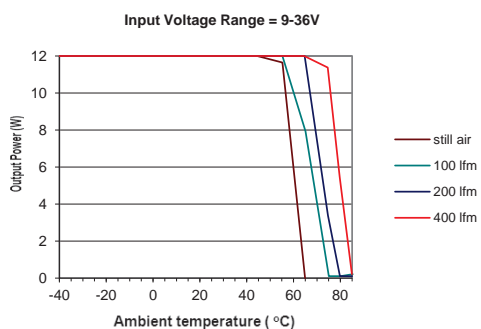

NCS12S1212C

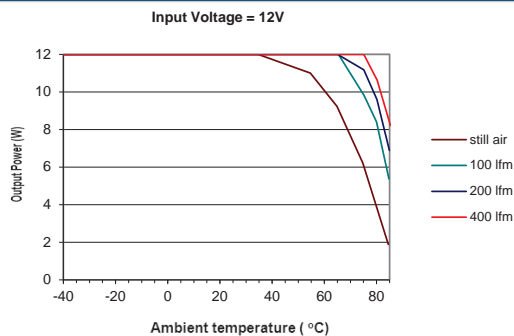
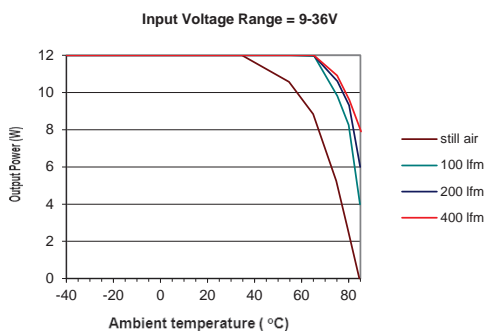

NCS12S1215C

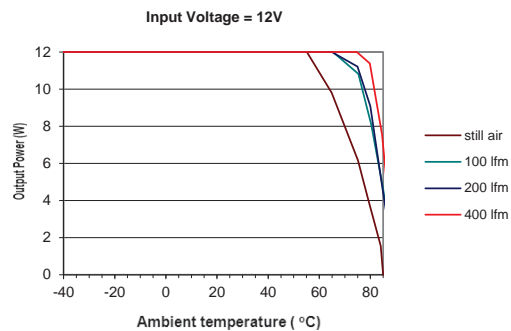
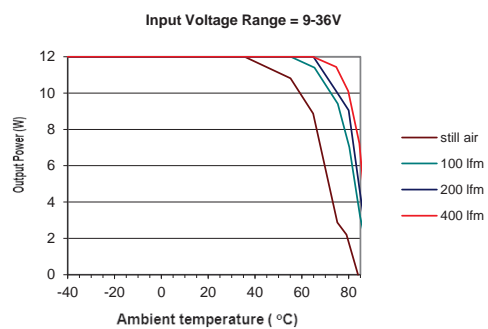

TEMPERATURE DERATING

NCS12S4803C

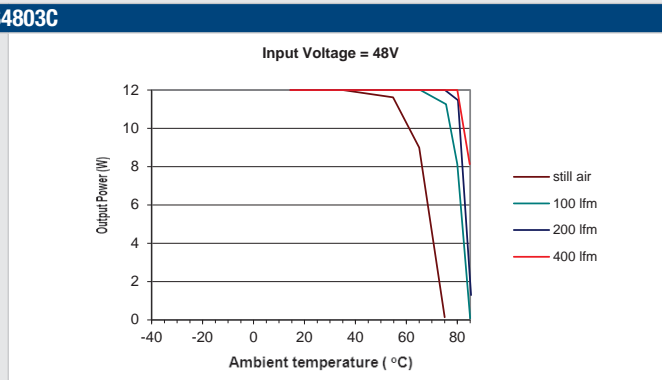
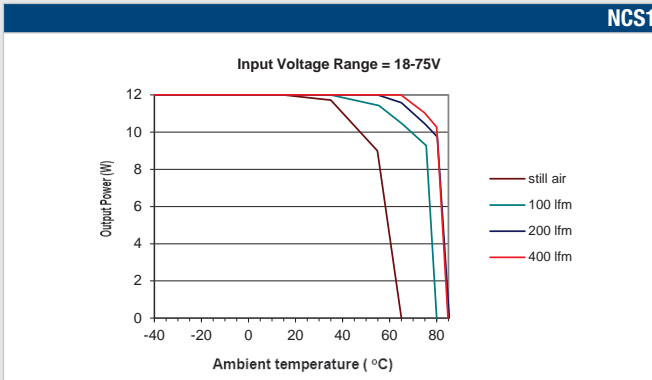

NCS12S4805C

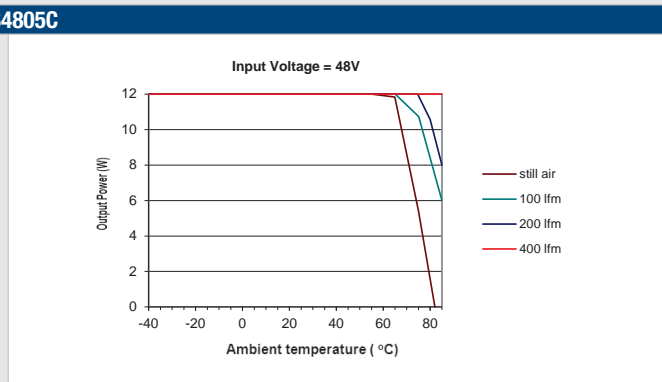
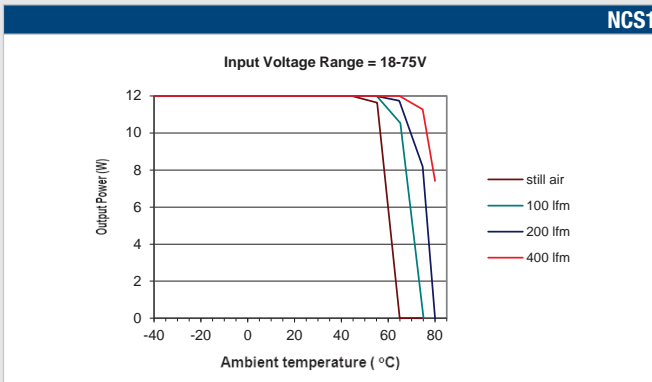

NCS12S4812C

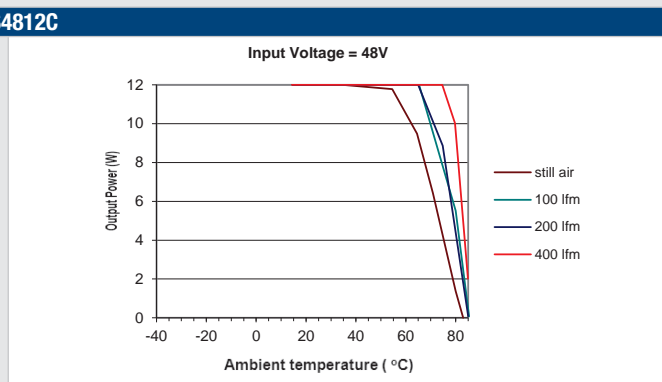
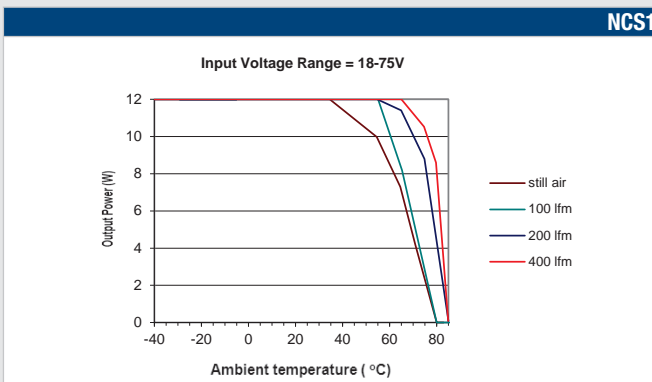

NCS12S4815C

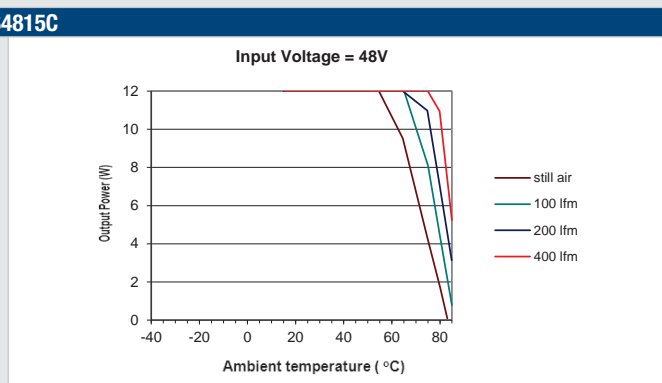
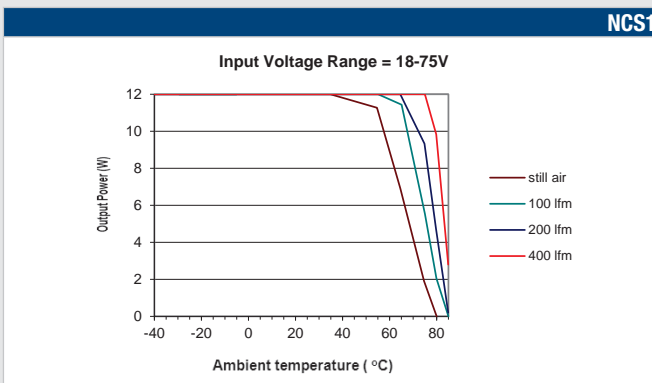

TEMPERATURE DERATING

NCS12D1205C

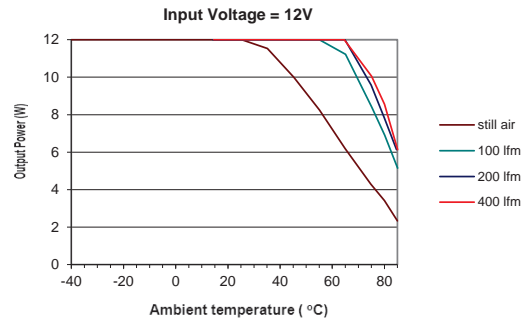
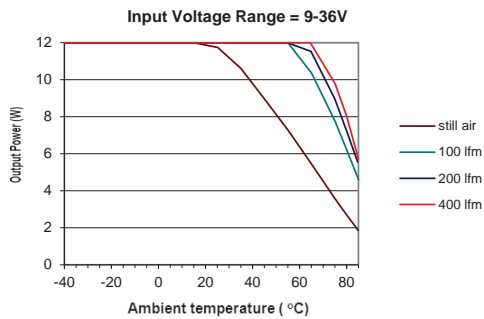

NCS12D1212C

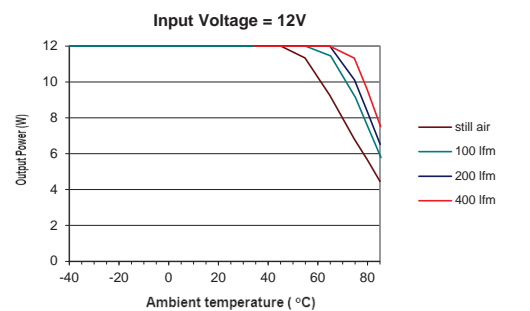
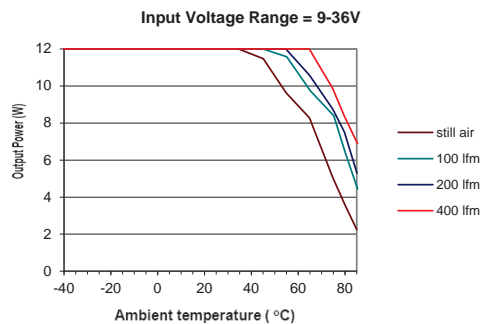

NCS12D1215C

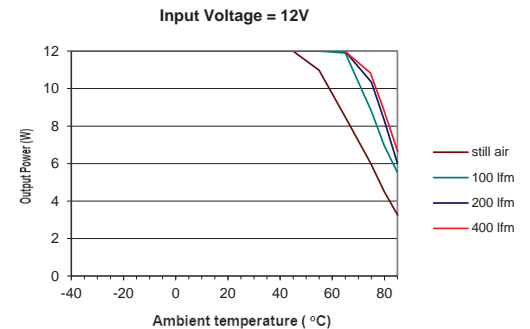
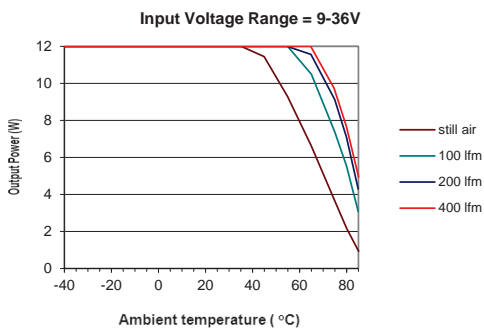

NCS12D4805C

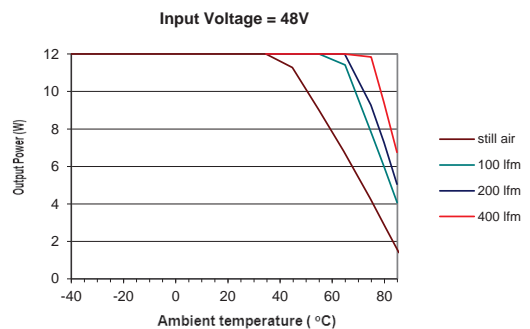
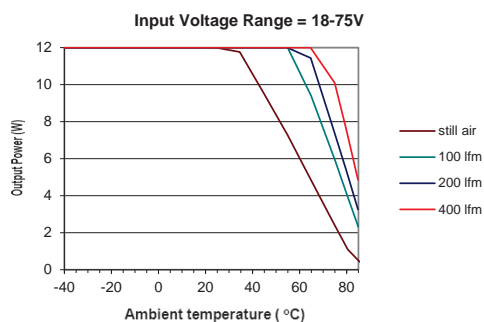

TEMPERATURE DERATING

NCS12D4812C

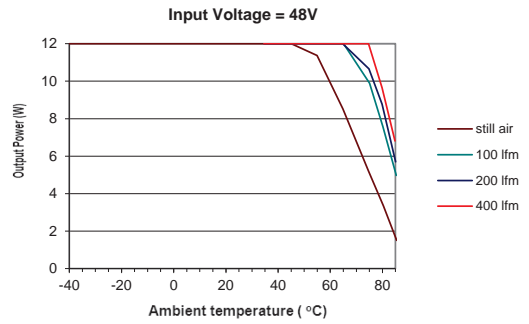
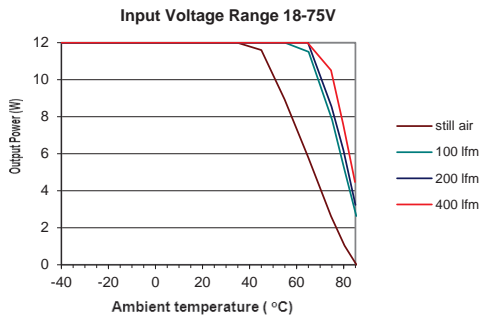

NCS12D4815C

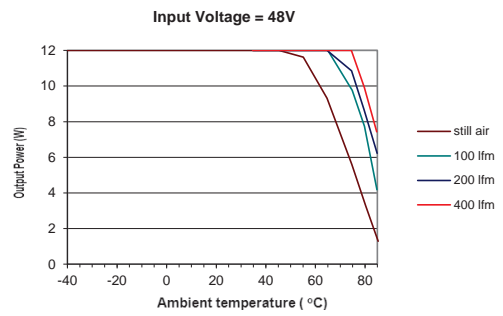
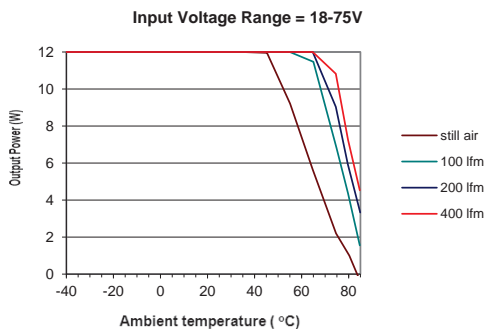

EMC FILTERING AND SPECTRA

FILTERING

The module includes a basic level of filtering, sufficient for many applications. Where lower noise levels are desired, filters can easily be added to achieve any required noise performance.

A DC/DC converter generates noise in two principle forms: that which is radiated from its body and that conducted on its external connections. There are three separate modes of conducted noise: input differential, output differential and input-output.

This last appears as common mode at the input and the output, and cannot therefore be removed by filtering at the input or output alone. The first level of filtering is to connect capacitors between input and output returns, to reduce this form of noise. It typically contains high harmonics of the switching frequency, which tend to appear as spikes on surrounding circuits. The voltage rating of this capacitor must match the required isolation voltage. (Due to the great variety in isolation voltage and required noise performance, this capacitor has not been included within the converter.)

Input ripple is a voltage developed across the internal Input decoupling capacitor. It is therefore measured with a defined supply source impedance. Although simple series inductance will provide filtering, on its own it can degrade the stability. A shunt capacitor is therefore recommended across the converter input terminals, so that it is fed from a low impedance.

If no filtering is required, the inductance of long supply wiring could also cause a problem, requiring an input decoupling capacitor for stability. An electrolytic will perform well in these situations. The input-output filtering is performed by the common-mode choke on the primary. This could be placed on the output, but would then degrade the regulation and produce less benefit for a given size, cost, and power loss.

Radiated noise is present in magnetic and electrostatic forms. The latter is suppressed by the metal case, which is connected to the output return, typically a zero-volt point. Thanks to the small size of these units, neither form of noise will be radiated "efficiently", so will not normally cause a problem. Any question of this kind usually better repays attention to conducted signals.

EMC FILTER AND VALUES TO OBTAIN SPECTRA AS SHOWN

The following filter circuit shows the input filter typically required to meet CISPR22 Quasi-PeakCurve B.

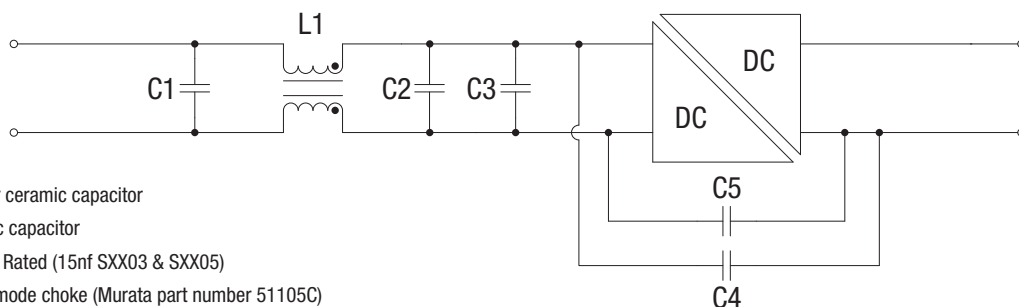

- C1, C2** 1µF Polyester or ceramic capacitor
- C3** 47µF Electrolytic capacitor
- C4 & C5** 10nF 250 VAC Y Rated (15nf SXX03 & SXX05)
- L1** 1mH Common-mode choke (Murata part number 51105C)

EMC FILTERING AND SPECTRA

NCS12S1203C

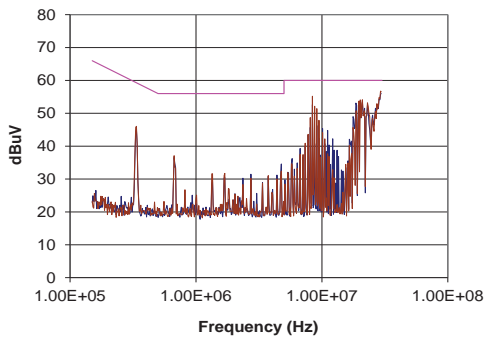

NCS12S1205C

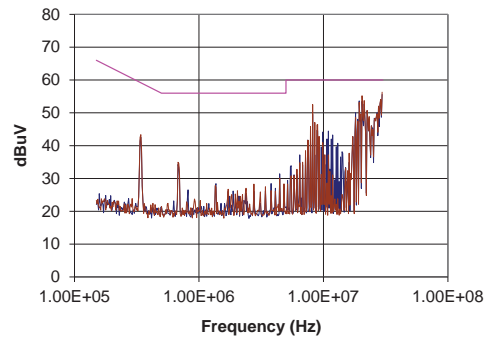

NCS12S1212C

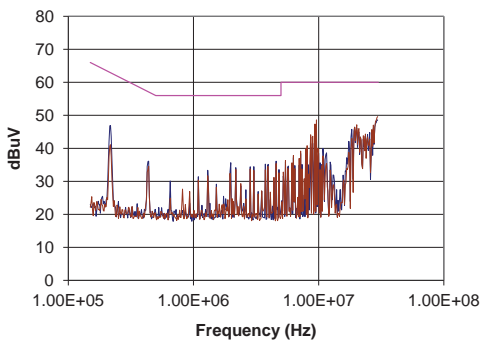

NCS12S1215C

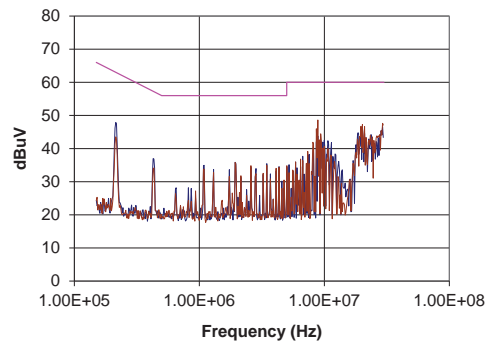

NCS12S4803C

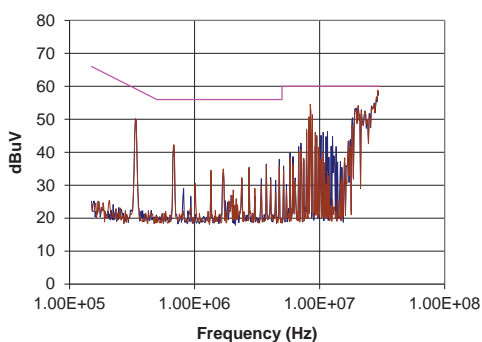

NCS12S4805C

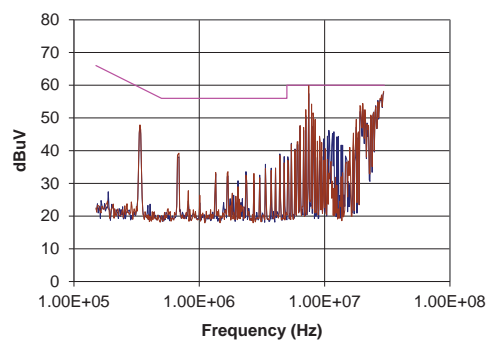

NCS12S4812C

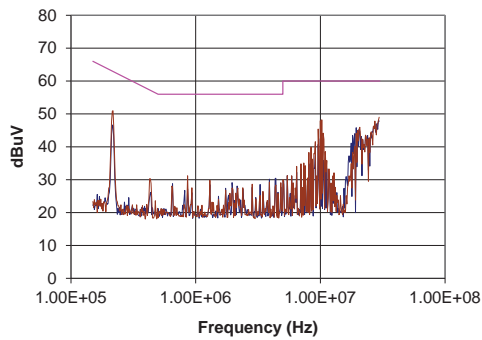

NCS12S4815C

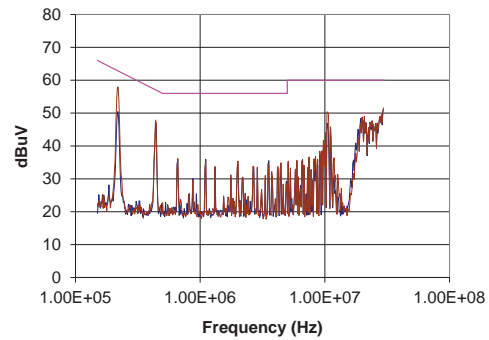

EMC FILTERING AND SPECTRA

NCS12D1205C

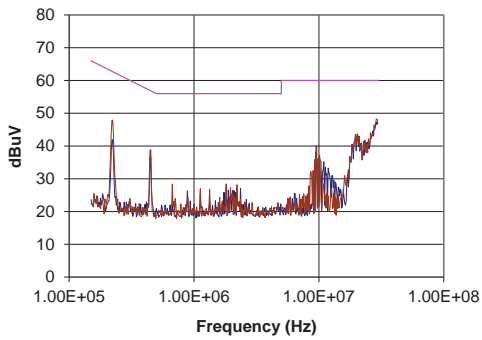

NCS12D1212C

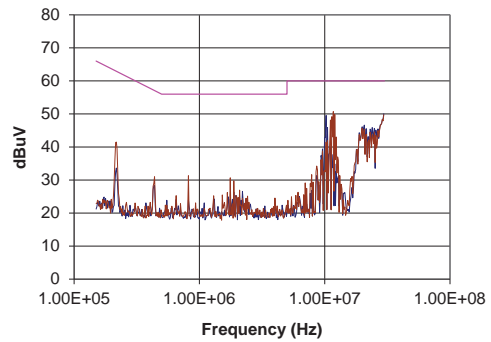

NCS12D1215C

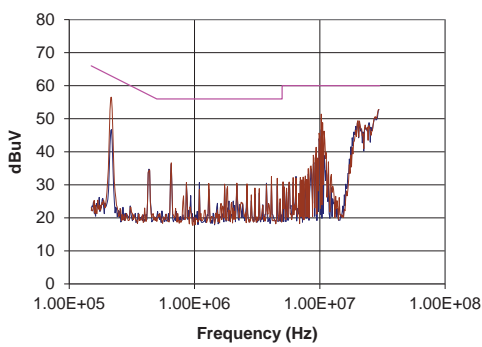

NCS12D4805C

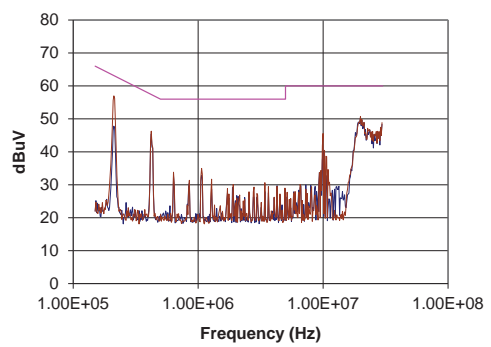

NCS12D4812C

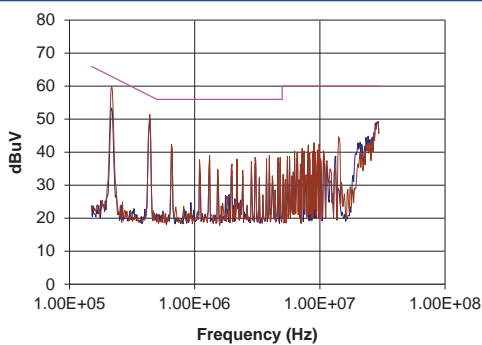

NCS12D4815C

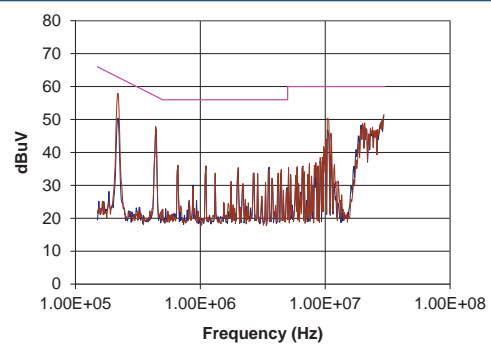

PACKAGE SPECIFICATIONS

MECHANICAL DIMENSIONS

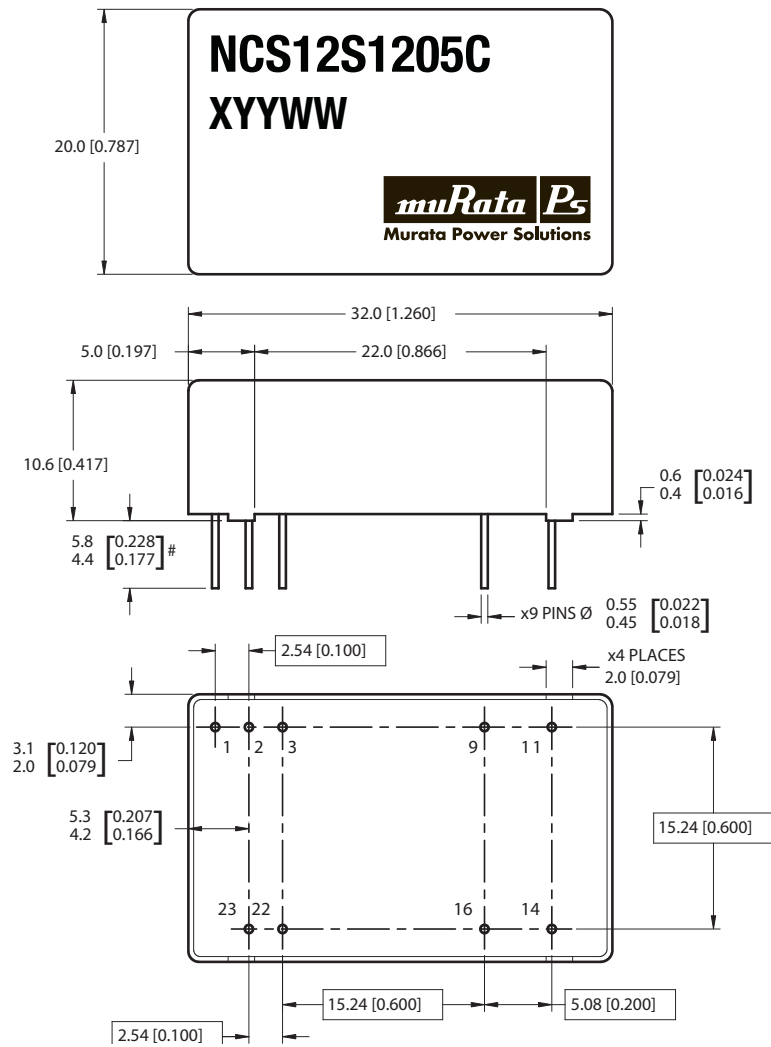

The pin length of the following variants is 4.2-5.3 (0.165-0.209) ; NCS12Sxx03C & NCS12Sxx05SC

All dimensions in mm (inches)
Tolerances (unless otherwise stated) ±0.4 (0.016).
All pins on a 2.54(0.100) pitch and within 0.25(0.010) of true position.

Weight: 17g

PIN CONNECTIONS

| Pin | Function | |
|-----|----------|---------|
| | Single | Dual |
| 1 | Control | Control |
| 2 | -VIN | -VIN |
| 3 | -VIN | -VIN |
| 9 | No pin | 0V |
| 11 | N/C | -VOUT |
| 14 | +VOUT | +VOUT |
| 16 | 0V | 0V |
| 22 | +VIN | +VIN |
| 23 | +VIN | +VIN |

TUBE OUTLINE DIMENSIONS

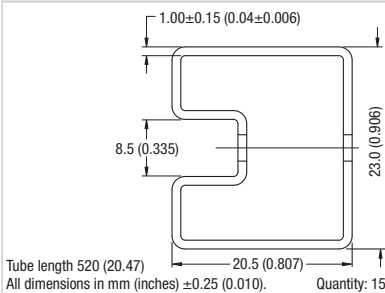

Tube length 520 (20.47)
All dimensions in mm (inches) ±0.25 (0.010). Quantity: 15

RECOMMENDED FOOTPRINT DETAILS

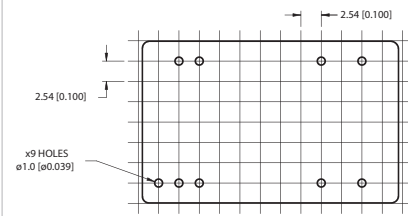

All dimensions in mm (inches) ±0.25 (± 0.010).

Murata Power Solutions, Inc.
11 Cabot Boulevard, Mansfield, MA 02048-1151 U.S.A.
ISO 9001 and 14001 REGISTERED



This product is subject to the following **operating requirements** and the **Life and Safety Critical Application Sales Policy**:
Refer to: <http://www.murata-ps.com/requirements/>

Murata Power Solutions, Inc. makes no representation that the use of its products in the circuits described herein, or the use of other technical information contained herein, will not infringe upon existing or future patent rights. The descriptions contained herein do not imply the granting of licenses to make, use, or sell equipment constructed in accordance therewith. Specifications are subject to change without notice.
© 2016 Murata Power Solutions, Inc.