



FEATURES

- RoHS compliant
- 0.28μH to 1.0mH
- Up to 8.7A I_{DC}
- Bobbin format
- Surface mount
- Integral EMI shield
- Compact size
- Tape and reel packaging
- UL 94V-0 materials
- J-STD-020-C reflow

DESCRIPTION

The 4600 series is a range of bobbin-wound, shielded inductors suitable for power-line filtering found in consumer electronics such as desktop computers, LED applications and GPS systems, as well as in a vast range of industrial and telecom applications including network hubs, bridges & routers, and high frequency wireless communication devices.

These surface mount inductors are extremely compact and have an integral shield, making them useful in EMI sensitive applications.

PIN CONNECTIONS (TOP VIEW)

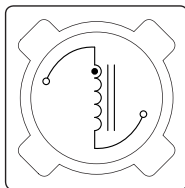

SELECTION GUIDE

| Order Code | Inductance (10kHz, 0.1VAC) ±20% | DC Current ¹ | DC Resistance |
|------------|---------------------------------------|-------------------------|---------------|
| | Nom. | Max. | Max. |
| | μH | A | mΩ |
| 46281C | 0.28 (±30%) | 8.7 | 8 |
| 46541C | 0.54 (±30%) | 7.7 | 10 |
| 46102C | 1.0 (±30%) | 6.8 | 13 |
| 46152C | 1.5 (±30%) | 6.3 | 15 |
| 46222C | 2.2 (±30%) | 5.0 | 21 |
| 46332C | 3.3 (±30%) | 4.3 | 29 |
| 46472C | 4.7 (±30%) | 3.7 | 37 |
| 46682C | 6.8 (±30%) | 3.1 | 52 |
| 46103C | 10 | 2.4 | 66 |
| 46153C | 15 | 2.2 | 94 |
| 46223C | 22 | 1.8 | 120 |
| 46333C | 33 | 1.45 | 190 |
| 46473C | 47 | 1.25 | 260 |
| 46683C | 68 | 1.05 | 360 |
| 46104C | 100 | 0.86 | 500 |
| 46154C | 150 | 0.72 | 720 |
| 46224C | 220 | 0.57 | 1050 |
| 46334C | 330 | 0.46 | 1850 |
| 46474C | 470 | 0.39 | 2800 |
| 46684C | 680 | 0.32 | 3900 |
| 46105C | 1000 | 0.27 | 4900 |

MECHANICAL DIMENSIONS

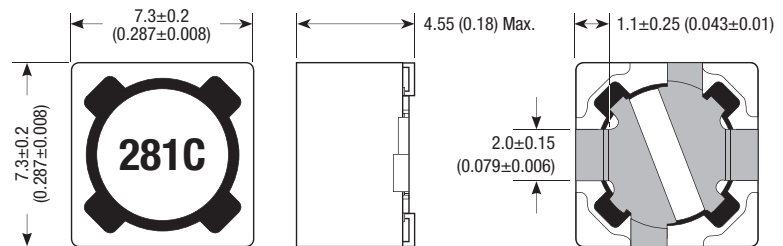

Recommended Footprint Details*

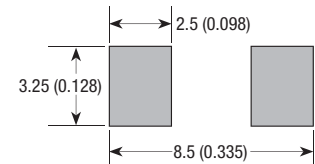

*Distance between the outside ends of the terminations is 7.1±0.1 (0.28±0.004)
Unless otherwise stated, all dimensions in mm (inches) ± 0.25 (0.010).
Package weight: 0.8g Typ.

ABSOLUTE MAXIMUM RATINGS

| | |
|-----------------------------|----------------|
| Operating temperature range | -40°C to 125°C |
| Storage temperature range | -40°C to 150°C |

SOLDERING INFORMATION²

| | |
|--------------------------------|-------|
| Peak reflow solder temperature | 250°C |
| Pin finish | Tin |

Specifications typical at T_A = 25°C

1 Maximum DC current occurs when either the inductance falls to 75% of its nominal value or when its temperature rise reaches 40°C, whichever is sooner.

2 For further information, please visit www.murata-ps.com/rohs



INDUCTANCE Vs CURRENT

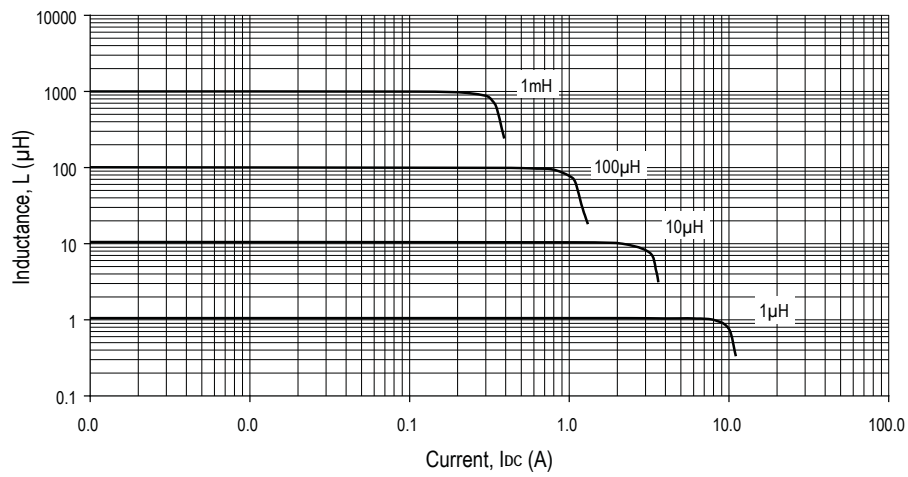

TEMPERATURE Vs CURRENT

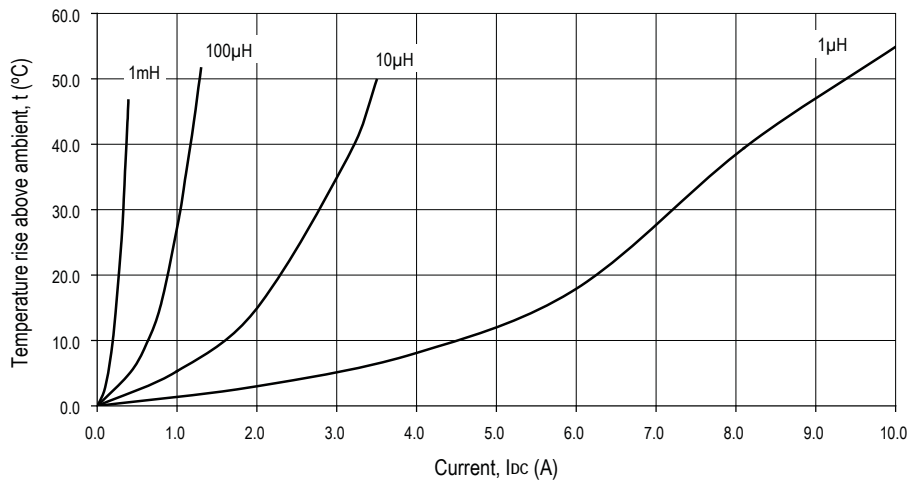

INDUCTANCE Vs FREQUENCY

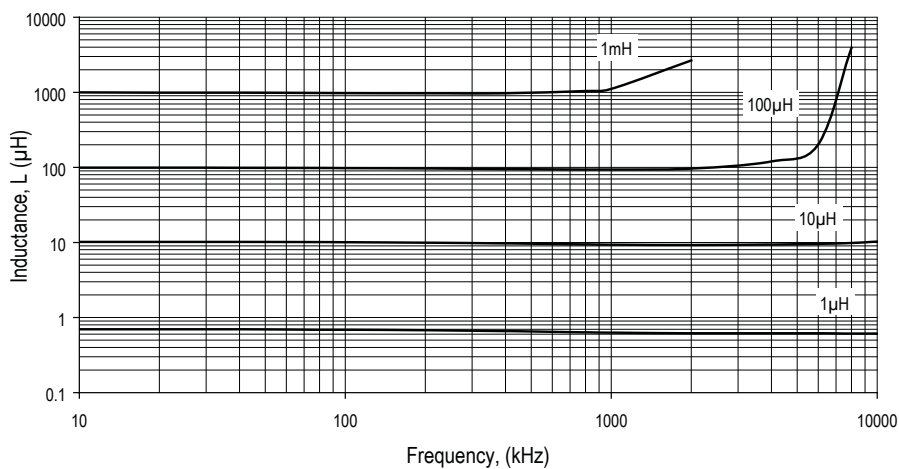

TAPE & REEL SPECIFICATIONS

REEL OUTLINE DIMENSIONS

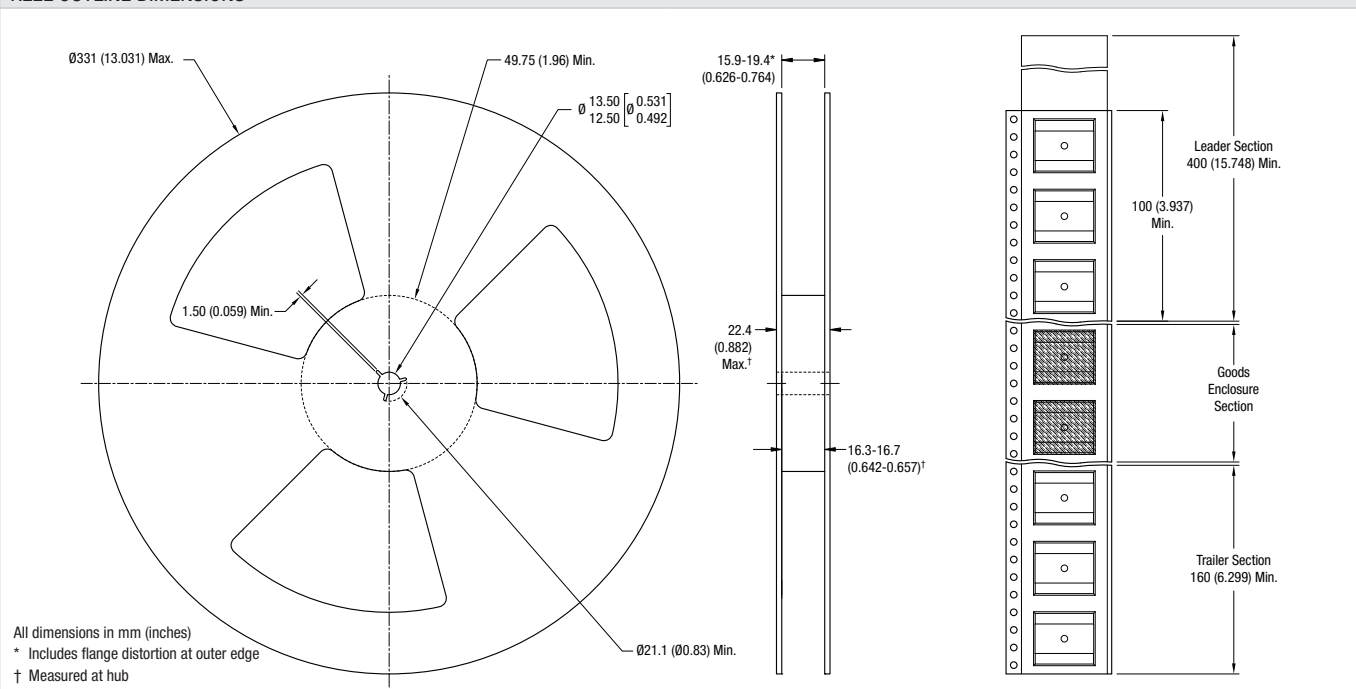

TAPE OUTLINE DIMENSIONS

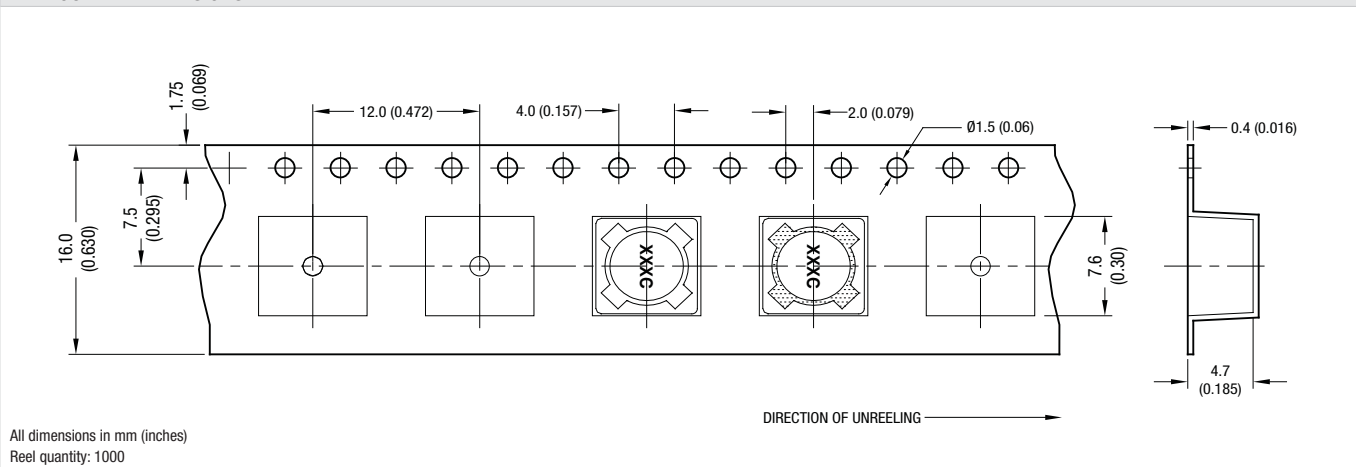

Murata Power Solutions, Inc.
11 Cabot Boulevard, Mansfield, MA 02048-1151 U.S.A.
ISO 9001 and 14001 REGISTERED

Murata Power Solutions, Inc. makes no representation that the use of its products in the circuits described herein, or the use of other technical information contained herein, will not infringe upon existing or future patent rights. The descriptions contained herein do not imply the granting of licenses to make, use, or sell equipment constructed in accordance therewith. Specifications are subject to change without notice.
© 2011 Murata Power Solutions, Inc.