



FEATURES

- RoHS compliant
- Up to 1.6A I_{DC}
- 4.7μH to 1mH
- Low R_{DC}
- Ultra-low profile
- UL 94V-0 packaging materials
- J-STD-020D reflow
- Custom inductance values available

PRODUCT OVERVIEW

The 2700 series is a range of ultra-low profile, surface-mount power inductors. They are designed for use in power applications with restricted height, such as handheld devices, DC-DC converters and notebook computers. The products are supplied in tape and reel for high-volume, automated surface-mount assembly.

SELECTION GUIDE

Order Code	Inductance, L	DC Current ²	DC Resistance
	±20% μH	Max. A	Max. Ω
27472C	4.7	1.6	0.10
27682C	6.8	1.4	0.13
27103C	10	1.1	0.15
27153C	15	0.9	0.23
27223C	22	0.75	0.30
27333C	33	0.6	0.45
27473C	47	0.5	0.70
27683C	68	0.42	0.90
27104C	100	0.35	1.30
27154C	150	0.28	2.00
27224C	220	0.24	3.00
27334C	330	0.19	4.50
27474C	470	0.16	6.50
27684C	680	0.14	8.50
27105C	1000	0.11	14.0

ABSOLUTE MAXIMUM RATINGS

Operating temperature range ³	-40°C to 125°C
Storage temperature range	-40°C to 150°C

SOLDERING INFORMATION¹

Peak reflow solder temperature	260°C
Pin finish	Gold
Moisture sensitivity level ⁴	1

PACKAGE SPECIFICATIONS

Mechanical Dimensions

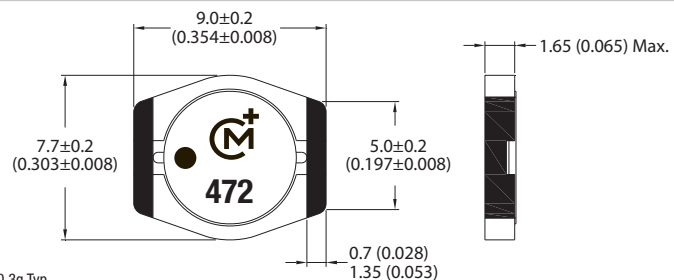

Package weight: 0.3g Typ.

Recommended Pad Layout

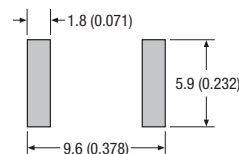

All dimensions in mm (inches)

Specifications typical at T_A = 25°C

1 For further information, please visit www.murata-ps.com/rohs

2 The maximum DC current is the value at which the inductance falls to 75% of its nominal value or when its temperature rise reaches 40°C, whichever is sooner.

3 Including self heating of the device.

4 Representative samples of the product were subjected to the conditioning described in IPC/JEDEC J-STD-020D and passed electrical testing, package coplanarity and visual inspection which revealed no external cracks or changes in package body flatness.



INDUCTANCE Vs CURRENT

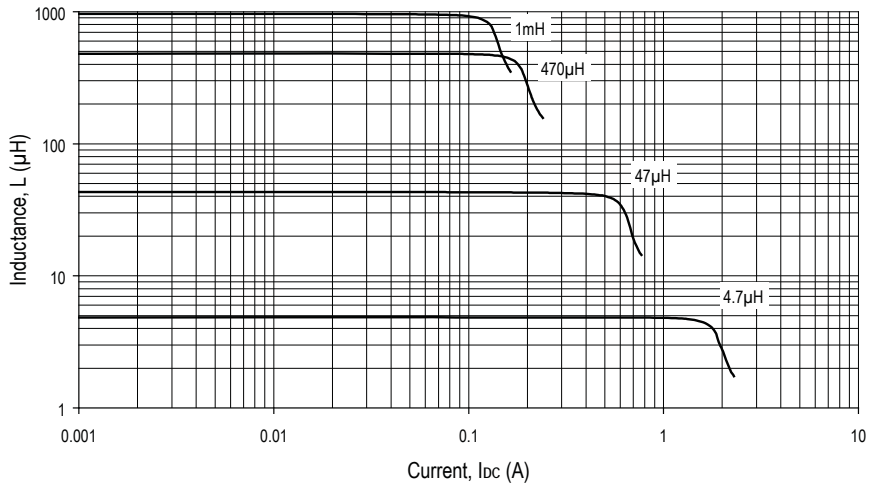

TEMPERATURE Vs CURRENT

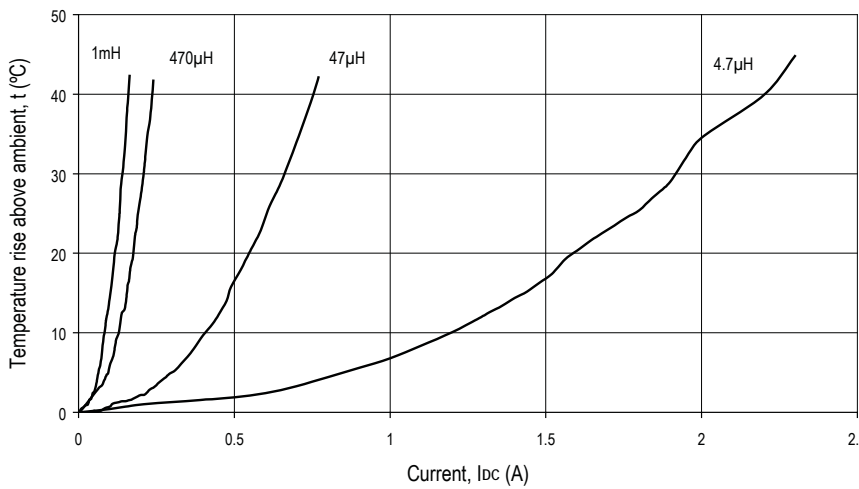

INDUCTANCE Vs FREQUENCY

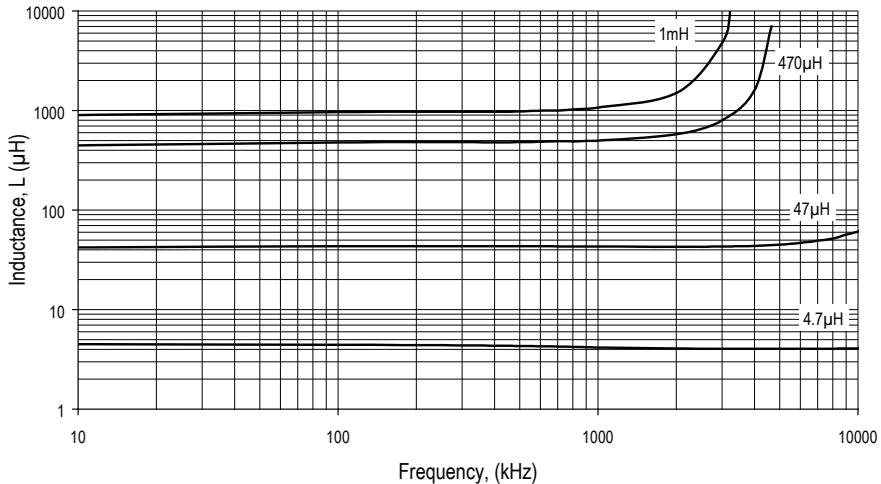

PACKAGE SPECIFICATIONS

Mechanical Dimensions

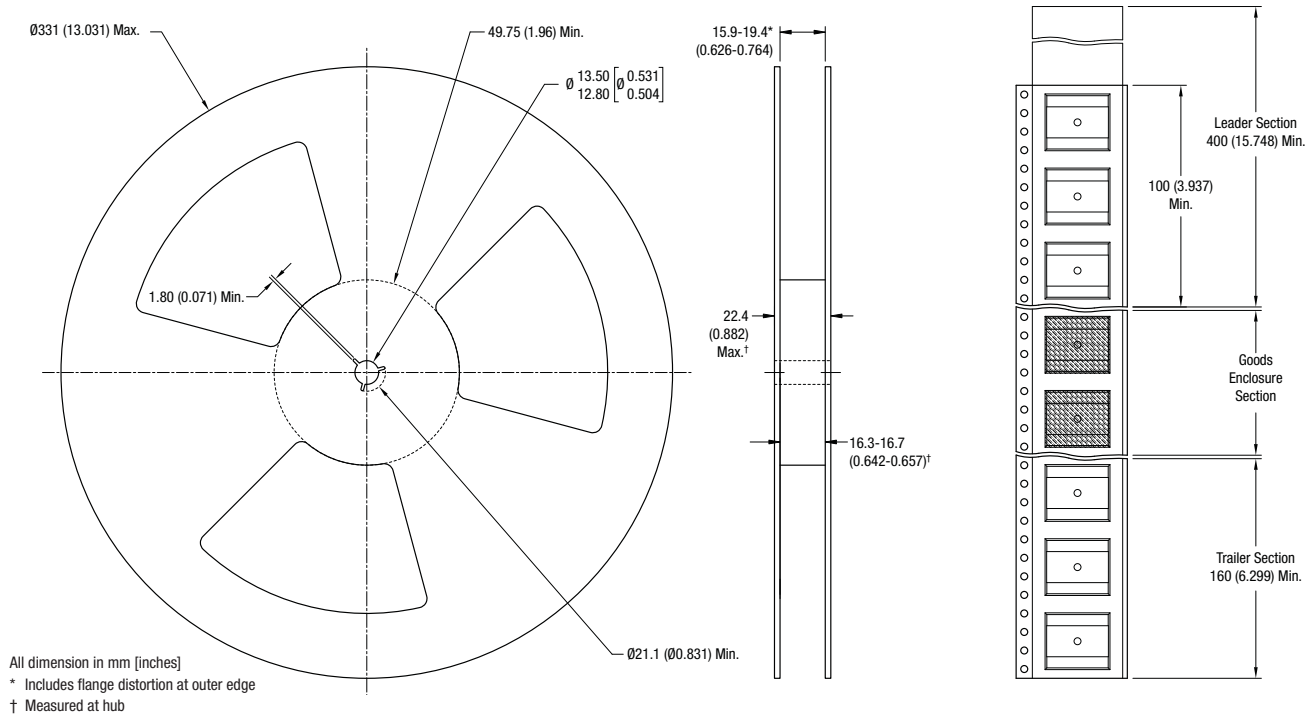

Tape Outline Dimensions

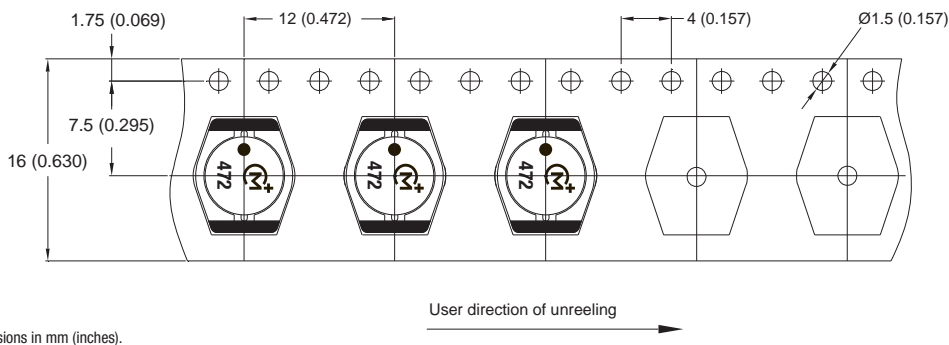

Murata Power Solutions, Inc.
11 Cabot Boulevard, Mansfield, MA 02048-1151 U.S.A.
ISO 9001 and 14001 REGISTERED

Murata Power Solutions, Inc. makes no representation that the use of its products in the circuits described herein, or the use of other technical information contained herein, will not infringe upon existing or future patent rights. The descriptions contained herein do not imply the granting of licenses to make, use, or sell equipment constructed in accordance therewith. Specifications are subject to change without notice.
© 2011 Murata Power Solutions, Inc.