



## FEATURES

- RoHS compliant
- Up to 2.0A lbc
- 1.0μH to 330μH
- Low Rbc
- Ultra-low profile
- UL 94V-0 packaging materials
- J-STD-020D reflow
- Custom inductance values available

## PRODUCT OVERVIEW

The 2700T series is a range of ultra-low profile, surface-mount power inductors. They are designed for use in power applications with restricted height, such as handheld devices, DC-DC converters and notebook computers. The products are supplied in tape and reel for high-volume, automated surface-mount assembly.

## SELECTION GUIDE

Order Code	Inductance, L	DC Current <sup>2</sup>	DC Resistance
	±20% μH	Max. A	Max. Ω
27T102C	1.0	2.0	0.08
27T152C	1.5	1.6	0.10
27T222C	2.2	1.4	0.12
27T332C	3.3	1.2	0.16
27T472C	4.7	1.0	0.20
27T682C	6.8	0.85	0.32
27T103C	10	0.70	0.41
27T153C	15	0.60	0.55
27T223C	22	0.50	0.85
27T333C	33	0.40	1.30
27T473C	47	0.32	1.80
27T683C	68	0.28	2.50
27T104C	100	0.23	3.50
27T154C	150	0.17	5.00
27T224C	220	0.15	7.00
27T334C	330	0.13	15.0

## ABSOLUTE MAXIMUM RATINGS

Operating temperature range <sup>3</sup>	-40°C to 125°C
Storage temperature range	-40°C to 150°C

## SOLDERING INFORMATION<sup>1</sup>

Peak reflow solder temperature	260°C
Pin finish	Gold
Moisture sensitivity level <sup>4</sup>	1

## PACKAGE SPECIFICATIONS

### Mechanical Dimensions

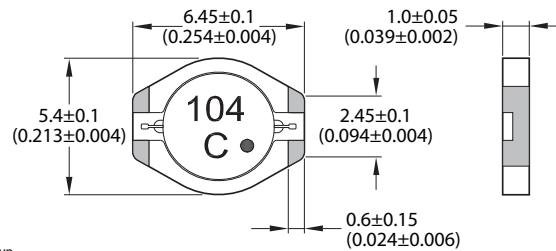

### Recommended Pad Layout

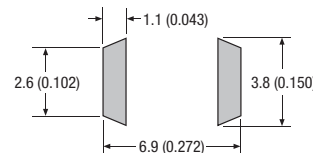

All dimensions in mm (inches)

Specifications typical at T<sub>A</sub> = 25°C

1 For further information, please visit [www.murata-ps.com/rohs](http://www.murata-ps.com/rohs)

2 The maximum DC current is the value at which the inductance falls to 75% of its nominal value or when its temperature rise reaches 40°C, whichever is sooner.

3 Including self heating of the device.

4 Representative samples of the product were subjected to the conditioning described in IPC/JEDEC J-STD-020D and passed electrical testing, package coplanarity and visual inspection which revealed no external cracks or changes in package body flatness.



**INDUCTANCE Vs CURRENT**

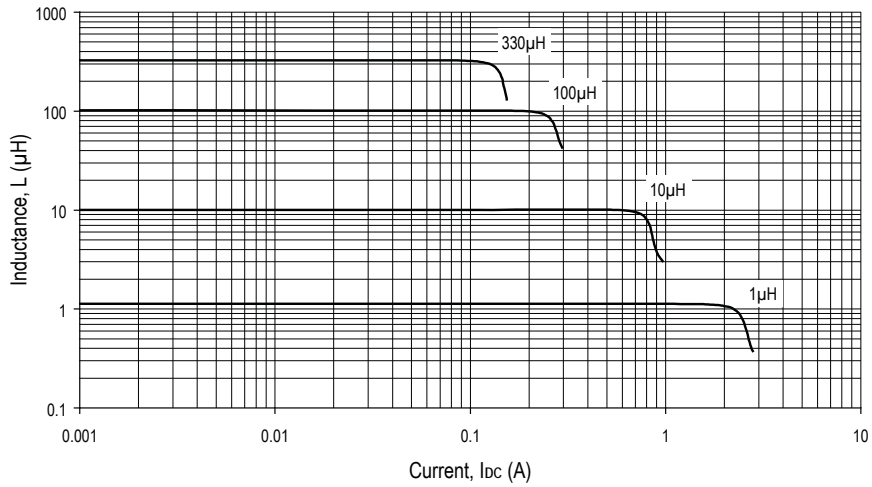

**TEMPERATURE Vs CURRENT**

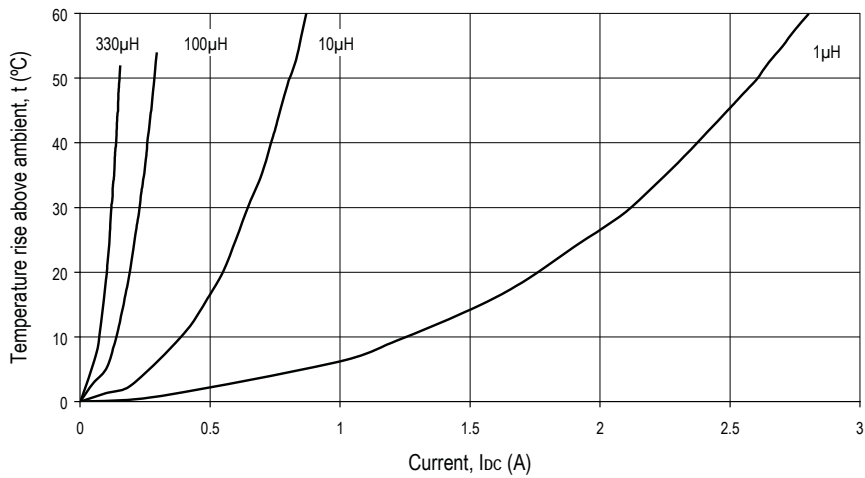

**INDUCTANCE Vs FREQUENCY**

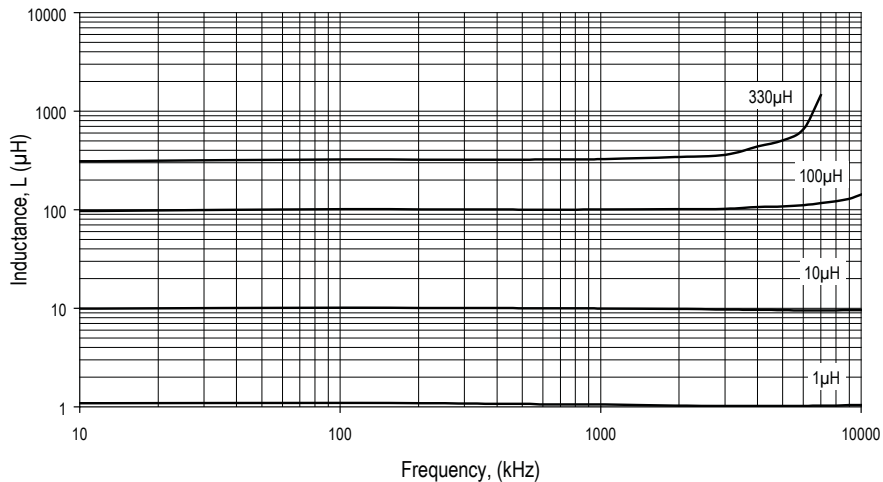

**PACKAGE SPECIFICATIONS**

**Mechanical Dimensions**

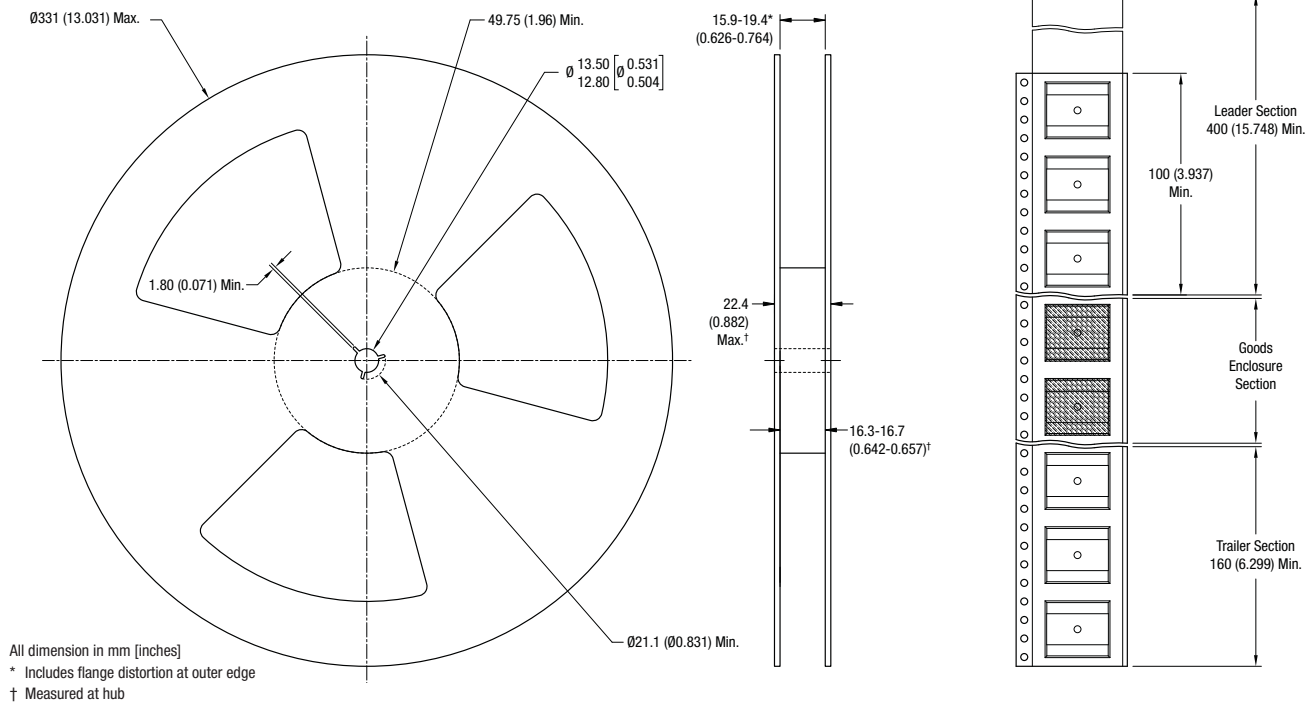

**Tape Outline Dimensions**

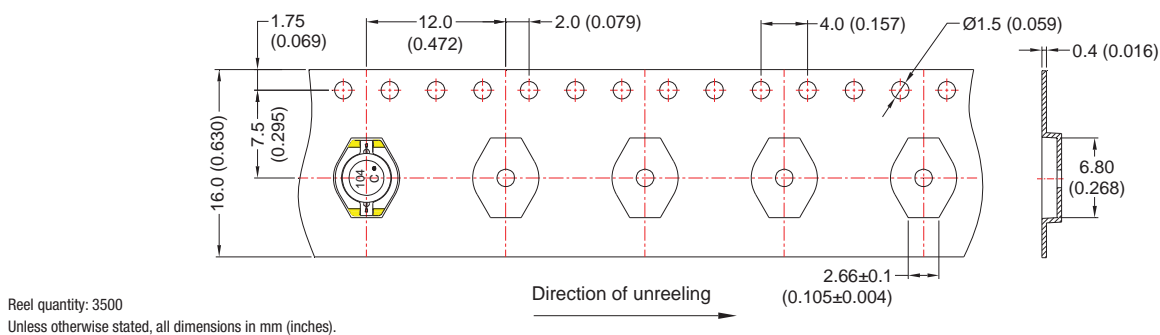

Murata Power Solutions, Inc.  
11 Cabot Boulevard, Mansfield, MA 02048-1151 U.S.A.  
ISO 9001 and 14001 REGISTERED

Murata Power Solutions, Inc. makes no representation that the use of its products in the circuits described herein, or the use of other technical information contained herein, will not infringe upon existing or future patent rights. The descriptions contained herein do not imply the granting of licenses to make, use, or sell equipment constructed in accordance therewith. Specifications are subject to change without notice.  
© 2011 Murata Power Solutions, Inc.