



FEATURES

- RoHS compliant
- 1.0μH to 400μH¹
- Up to 9.5A IDC
- Bobbin format
- Dual winding
- Surface mount
- Integral EMI shield
- Compact size
- Tape and reel packaging
- J-STD-020-C reflow
- Backwards compatible with Sn/Pb soldering systems

PRODUCT OVERVIEW

The 4700 series is a range of dual wound inductors offering flexible options. Windings can be connected in series or parallel to create a wide range of inductance combinations. They can also be used as common mode chokes or 1:1 transformers with the secondary winding used as a feedback winding in switched mode power supplies.

PIN CONNECTIONS (TOP VIEW)

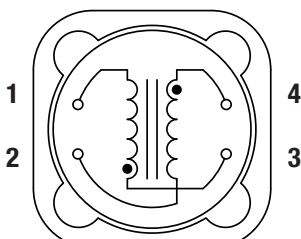

3 & 1 = Primary winding
4 & 2 = Secondary winding



For full details go to
www.murata-ps.com/rohs

SELECTION GUIDE

Order Code	Inductance ¹ (10kHz, 100mVAC) 1&3, 2&4	Inductance Range (10kHz, 100mVAC) 1&3, 2&4	DC Current ² (parallel connection)	DC Resistance 1&3, 2&4
	Nom.	Min. - Max.	Max.	Max.
	μH	μH	A	mΩ
471R0C	1.0	0.83 - 1.39	9.50	8.9
472R2C	2.2	1.38 - 2.30	6.80	13.7
473R3C	3.3	2.87 - 4.79	5.50	23.3
474R7C	4.7	4.08 - 6.12	4.60	32.4
476R8C	6.8	5.24 - 7.86	3.90	44.8
47100C	10	8.00 - 12.0	3.20	70.2
47150C	15	11.3 - 17.0	2.60	106
47220C	22	17.4 - 26.1	2.10	165
47330C	33	27.6 - 41.4	1.80	207
47470C	47	36.7 - 55.1	1.47	298
47680C	68	54.9 - 82.3	1.22	456
47101C	100	81.4 - 122	1.01	686

MECHANICAL DIMENSIONS

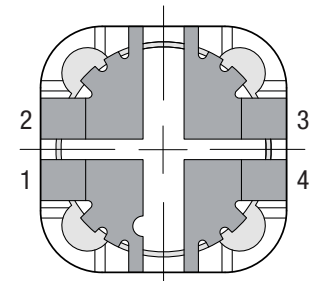
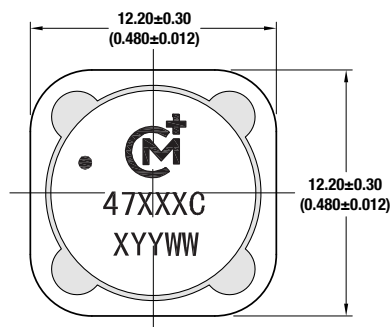

Recommended Footprint Details

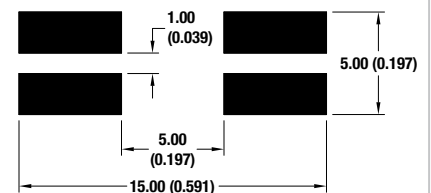
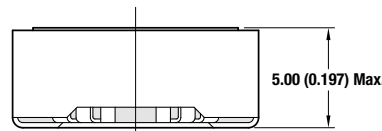

All dimensions in mm (inches). Package weight: 2.5g Typ.

ABSOLUTE MAXIMUM RATINGS

Isolation voltage (flash tested for 1 second), pins 3 & 4	500VDC
Operating free air temperature range	-40°C to 85°C
Storage temperature range	-40°C to 125°C

SOLDERING INFORMATION³

Peak reflow temperature	245°C
Pin finish	Tin

Specifications typical at T_a = 25°C

1 When connecting windings in series, inductance will be 4 times the nominal figure shown.

2 If current is flowing in both windings, the maximum DC current occurs when either the inductance falls to 85% of its nominal value or when its temperature rise reaches 40°C, whichever is sooner.

3 For further information, please visit www.murata-ps.com/rohs

TAPE & REEL SPECIFICATIONS

REEL OUTLINE DIMENSIONS

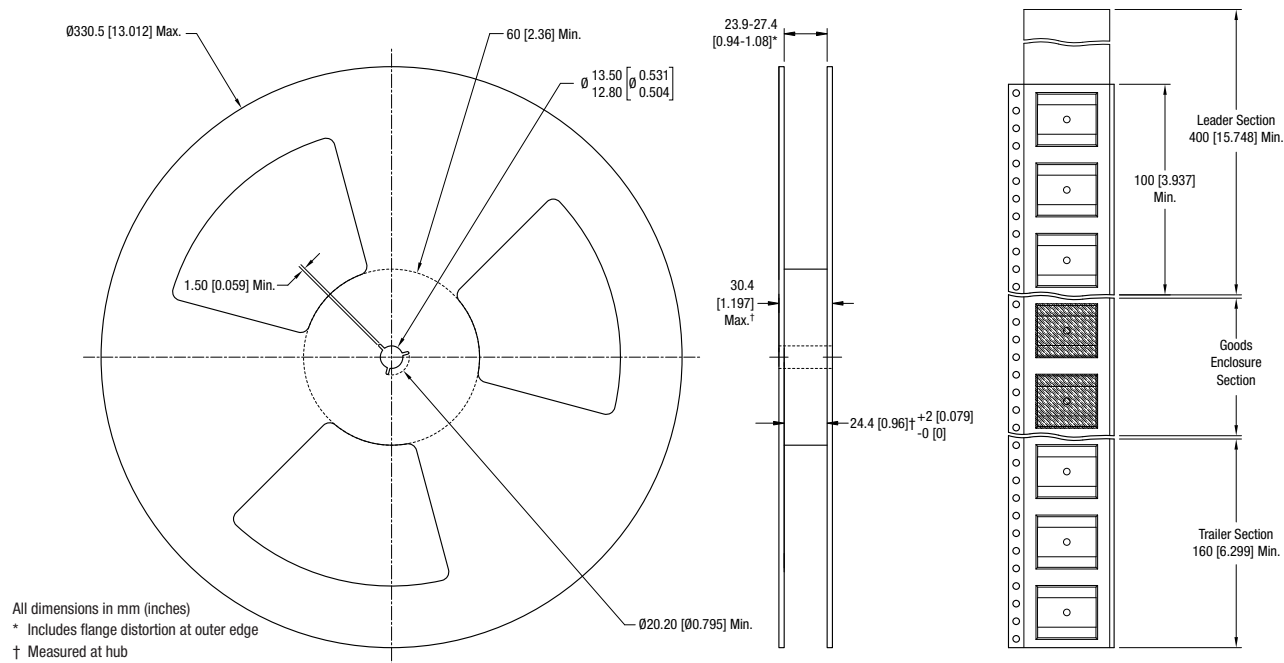

TAPE OUTLINE DIMENSIONS

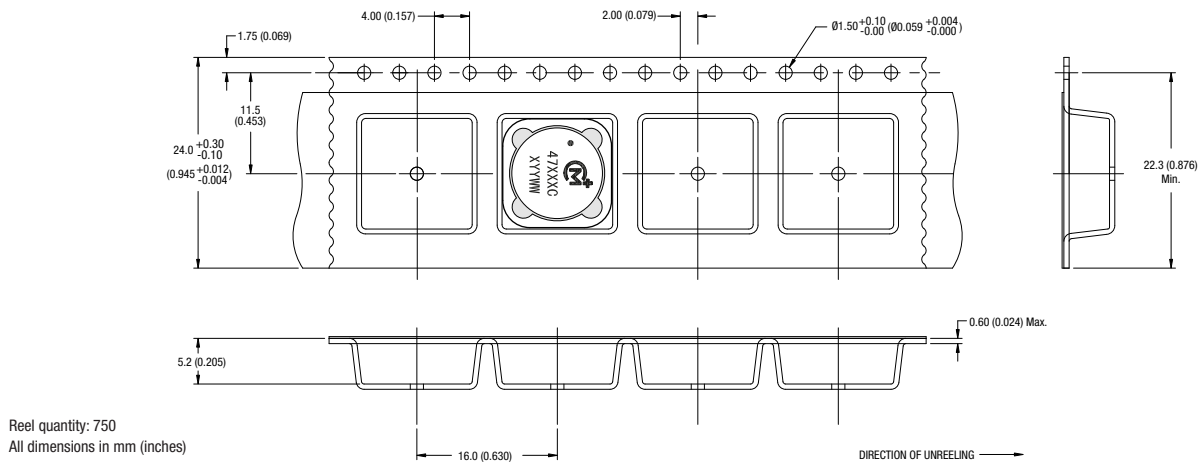

Murata Power Solutions, Inc.
 11 Cabot Boulevard, Mansfield, MA 02048-1151 U.S.A.
 ISO 9001 and 14001 REGISTERED

Murata Power Solutions, Inc. makes no representation that the use of its products in the circuits described herein, or the use of other technical information contained herein, will not infringe upon existing or future patent rights. The descriptions contained herein do not imply the granting of licenses to make, use, or sell equipment constructed in accordance therewith. Specifications are subject to change without notice.
 © 2016 Murata Power Solutions, Inc.