



FEATURES

- RoHS compliant
- Up to 2.8A I_{DC}
- 1.0μH to 2.2mH
- Low R_{DC}
- Small footprint
- Ultra-low profile
- UL 94V-0 packaging materials
- J-STD-020C reflow
- Custom inductance values available

PRODUCT OVERVIEW

The 8400 series is a range of miniature, surface-mount, I-core power inductors. They are designed for use in power applications with restricted PCB space and height, such as ExpressCard™ technology, handheld devices, DC-DC converters and notebook computers. The products are supplied in tape and reel for high-volume, automated surface-mount assembly.

SELECTION GUIDE

| Order Code | Inductance, L | DC Current ² | DC Resistance |
|------------|---------------|-------------------------|---------------|
| | ±10% μH | Max. A | Max. Ω |
| 84102C | 1.0±20% | 2.80 | 0.08 |
| 84132C | 1.3±20% | 2.50 | 0.08 |
| 84222C | 2.2±20% | 2.00 | 0.09 |
| 84332C | 3.3±20% | 1.50 | 0.12 |
| 84472C | 4.7±20% | 1.30 | 0.15 |
| 84682C | 6.8±20% | 1.05 | 0.20 |
| 84103C | 10 | 0.95 | 0.24 |
| 84153C | 15 | 0.75 | 0.45 |
| 84223C | 22 | 0.60 | 0.60 |
| 84333C | 33 | 0.55 | 0.86 |
| 84473C | 47 | 0.42 | 1.1 |
| 84683C | 68 | 0.38 | 1.6 |
| 84104C | 100 | 0.30 | 2.0 |
| 84154C | 150 | 0.25 | 3.2 |
| 84224C | 220 | 0.20 | 4.6 |
| 84334C | 330 | 0.17 | 6.5 |
| 84474C | 470 | 0.14 | 8.5 |
| 84684C | 680 | 0.12 | 11.5 |
| 84105C | 1000 | 0.09 | 18.0 |
| 84155C | 1500 | 0.08 | 27.0 |
| 84225C | 2200 | 0.05 | 45 |

ABSOLUTE MAXIMUM RATINGS

| | |
|--------------------------------------|----------------|
| Operating free air temperature range | -40°C to 125°C |
| Storage temperature range | -40°C to 150°C |

SOLDERING INFORMATION¹

| | |
|--------------------------------|---------|
| Peak reflow solder temperature | 250°C |
| Pin finish | SAC 305 |
| Moisture sensitivity level | 1 |

PACKAGE SPECIFICATIONS

Mechanical Dimensions

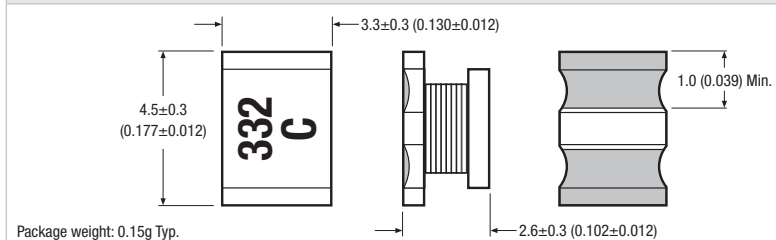

Recommended Footprint Details

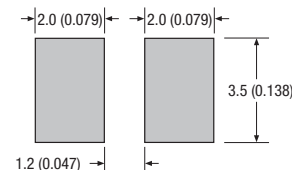

All dimensions in mm (inches)

Specifications typical at T_a = 25°C

¹ For further information, please visit www.murata-ps.com/rohs

² The maximum DC current is the value at which the inductance falls to 75% of its nominal value or when its temperature rise reaches 40°C, whichever is sooner.



INDUCTANCE Vs CURRENT

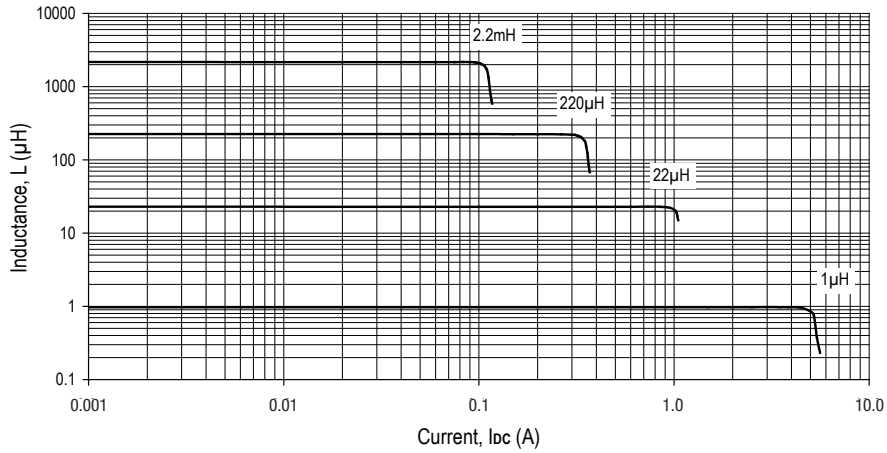

TEMPERATURE Vs CURRENT

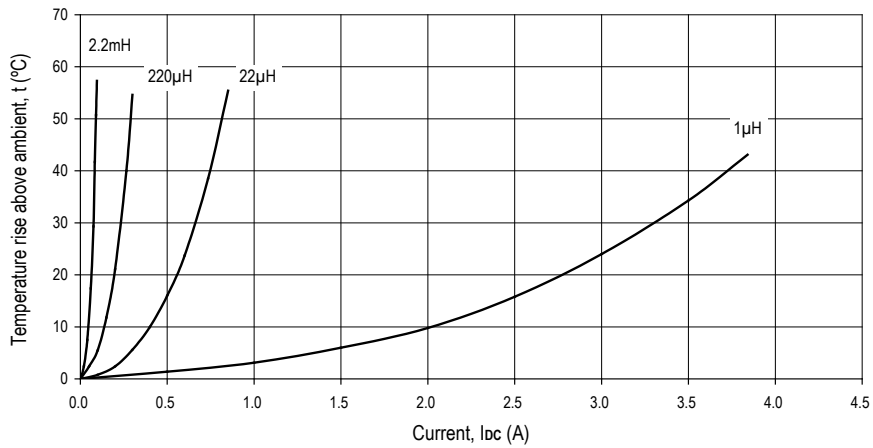

INDUCTANCE Vs FREQUENCY

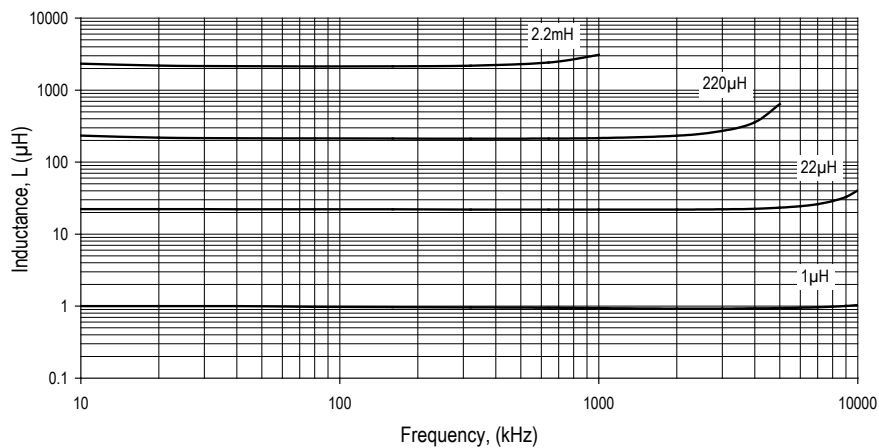

PACKAGE SPECIFICATIONS

Mechanical Dimensions

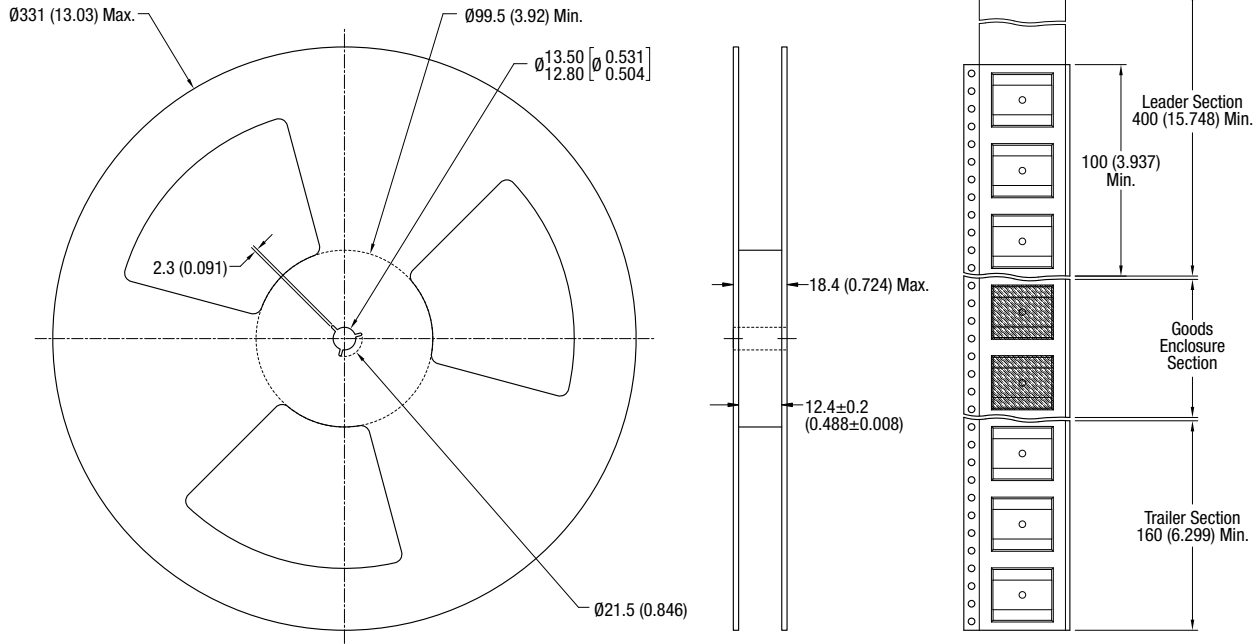

All dimension in mm [inches]

Tape Outline Dimensions

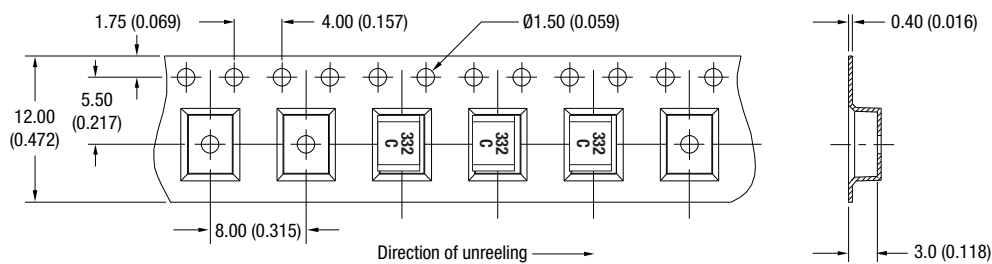

Reel quantity: 2000
Unless otherwise stated, all dimensions in mm (inches).

Murata Power Solutions, Inc.
11 Cabot Boulevard, Mansfield, MA 02048-1151 U.S.A.
ISO 9001 and 14001 REGISTERED

Murata Power Solutions, Inc. makes no representation that the use of its products in the circuits described herein, or the use of other technical information contained herein, will not infringe upon existing or future patent rights. The descriptions contained herein do not imply the granting of licenses to make, use, or sell equipment constructed in accordance therewith. Specifications are subject to change without notice.
© 2012 Murata Power Solutions, Inc.