

# Trimmer Potentiometers



## Lead Sealed Type Multiturn PV36 Series

### PV36 Series

#### ■ Features

1. Multiturn / Cermet / Sealed
2. Available in both top and side adjustment
3. Standoffs allow thorough PC board washing
4. Chevron seal design
5. RoHS compliant\*
6. For trimmer applications/processing guidelines, [click here](#)

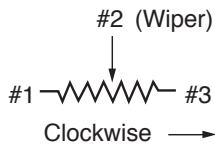

#### COMMON DIMENSIONS

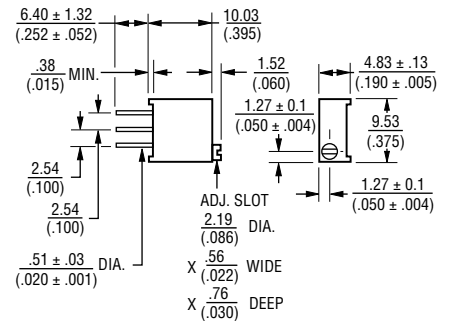

#### PV36W

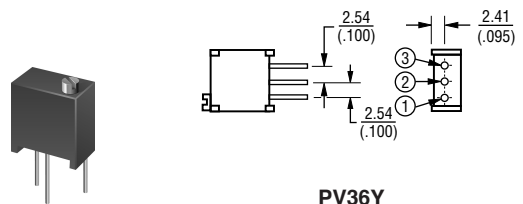

#### PV36Y

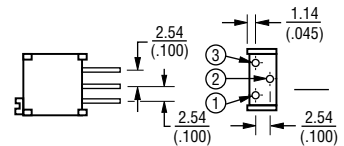

#### PV36X

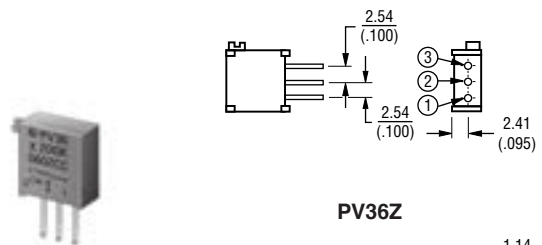

#### PV36Z

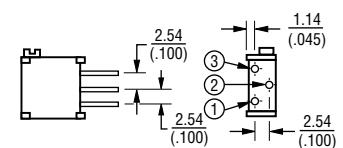

#### PV36P

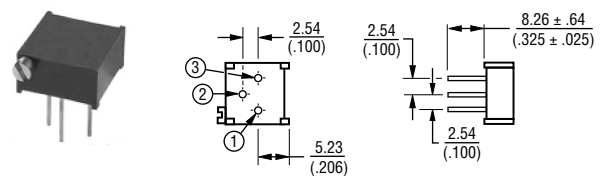

DIMENSIONS:  $\frac{\text{MM}}{\text{(INCHES)}}$   
 TOLERANCES:  $\pm \frac{0.25}{(.010)}$  EXCEPT WHERE NOTED



\*RoHS Directive 2002/95/EC Jan. 27, 2003 including annex and RoHS Recast 2011/65/EU June 8, 2011. Specifications are subject to change without notice. The device characteristics and parameters in this data sheet can and do vary in different applications and actual device performance may vary over time. Users should verify actual device performance in their specific applications.

## Top Adjustment

Part Number	Power Rating (W)	Number of Turns (Effective Rotation Angle)	Total Resistance Value	TCR (ppm/°C)
PV36W100C01B00	0.5 (70 °C)	25	10 ohm ±10 %	±150
PV36W200C01B00	0.5 (70 °C)	25	20 ohm ±10 %	±150
PV36W500C01B00	0.5 (70 °C)	25	50 ohm ±10 %	±150
PV36W101C01B00	0.5 (70 °C)	25	100 ohm ±10 %	±150
PV36W201C01B00	0.5 (70 °C)	25	200 ohm ±10 %	±100
PV36W501C01B00	0.5 (70 °C)	25	500 ohm ±10 %	±100
PV36W102C01B00	0.5 (70 °C)	25	1k ohm ±10 %	±100
PV36W202C01B00	0.5 (70 °C)	25	2k ohm ±10 %	±100
PV36W502C01B00	0.5 (70 °C)	25	5k ohm ±10 %	±100
PV36W103C01B00	0.5 (70 °C)	25	10k ohm ±10 %	±100
PV36W203C01B00	0.5 (70 °C)	25	20k ohm ±10 %	±100
PV36W253C01B00	0.5 (70 °C)	25	25k ohm ±10 %	±100
PV36W503C01B00	0.5 (70 °C)	25	50k ohm ±10 %	±100
PV36W104C01B00	0.5 (70 °C)	25	100k ohm ±10 %	±100
PV36W204C01B00	0.5 (70 °C)	25	200k ohm ±10 %	±100
PV36W254C01B00	0.5 (70 °C)	25	250k ohm ±10 %	±100
PV36W504C01B00	0.5 (70 °C)	25	500k ohm ±10 %	±100
PV36W105C01B00	0.5 (70 °C)	25	1M ohm ±10 %	±100
PV36W205C01B00	0.5 (70 °C)	25	2M ohm ±10 %	±100

PV36Y100C01B00	0.5 (70 °C)	25	10 ohm ±10 %	±150
PV36Y200C01B00	0.5 (70 °C)	25	20 ohm ±10 %	±150
PV36Y500C01B00	0.5 (70 °C)	25	50 ohm ±10 %	±150
PV36Y101C01B00	0.5 (70 °C)	25	100 ohm ±10 %	±150
PV36Y201C01B00	0.5 (70 °C)	25	200 ohm ±10 %	±100
PV36Y501C01B00	0.5 (70 °C)	25	500 ohm ±10 %	±100
PV36Y102C01B00	0.5 (70 °C)	25	1k ohm ±10 %	±100
PV36Y202C01B00	0.5 (70 °C)	25	2k ohm ±10 %	±100
PV36Y502C01B00	0.5 (70 °C)	25	5k ohm ±10 %	±100
PV36Y103C01B00	0.5 (70 °C)	25	10k ohm ±10 %	±100
PV36Y203C01B00	0.5 (70 °C)	25	20k ohm ±10 %	±100
PV36Y253C01B00	0.5 (70 °C)	25	25k ohm ±10 %	±100
PV36Y503C01B00	0.5 (70 °C)	25	50k ohm ±10 %	±100
PV36Y104C01B00	0.5 (70 °C)	25	100k ohm ±10 %	±100
PV36Y204C01B00	0.5 (70 °C)	25	200k ohm ±10 %	±100
PV36Y254C01B00	0.5 (70 °C)	25	250k ohm ±10 %	±100
PV36Y504C01B00	0.5 (70 °C)	25	500k ohm ±10 %	±100
PV36Y105C01B00	0.5 (70 °C)	25	1M ohm ±10 %	±100
PV36Y205C01B00	0.5 (70 °C)	25	2M ohm ±10 %	±100

Operating Temperature Range: -55 to +125 °C

Soldering Method: Wave (Single and Dual)

**BOURNS®**

Specifications are subject to change without notice.

The device characteristics and parameters in this data sheet can and do vary in different applications and actual device performance may vary over time. Users should verify actual device performance in their specific applications.

## Side Adjustment

Part Number	Power Rating (W)	Number of Turns (Effective Rotation Angle)	Total Resistance Value	TCR (ppm/°C)
PV36X100C01B00	0.5 (70 °C)	25	10 ohm ±10 %	±150
PV36X200C01B00	0.5 (70 °C)	25	20 ohm ±10 %	±150
PV36X500C01B00	0.5 (70 °C)	25	50 ohm ±10 %	±150
PV36X101C01B00	0.5 (70 °C)	25	100 ohm ±10 %	±150
PV36X201C01B00	0.5 (70 °C)	25	200 ohm ±10 %	±100
PV36X501C01B00	0.5 (70 °C)	25	500 ohm ±10 %	±100
PV36X102C01B00	0.5 (70 °C)	25	1k ohm ±10 %	±100
PV36X202C01B00	0.5 (70 °C)	25	2k ohm ±10 %	±100
PV36X502C01B00	0.5 (70 °C)	25	5k ohm ±10 %	±100
PV36X103C01B00	0.5 (70 °C)	25	10k ohm ±10 %	±100
PV36X203C01B00	0.5 (70 °C)	25	20k ohm ±10 %	±100
PV36X253C01B00	0.5 (70 °C)	25	25k ohm ±10 %	±100
PV36X503C01B00	0.5 (70 °C)	25	50k ohm ±10 %	±100
PV36X104C01B00	0.5 (70 °C)	25	100k ohm ±10 %	±100
PV36X204C01B00	0.5 (70 °C)	25	200k ohm ±10 %	±100
PV36X254C01B00	0.5 (70 °C)	25	250k ohm ±10 %	±100
PV36X504C01B00	0.5 (70 °C)	25	500k ohm ±10 %	±100
PV36X105C01B00	0.5 (70 °C)	25	1M ohm ±10 %	±100
PV36X205C01B00	0.5 (70 °C)	25	2M ohm ±10 %	±100

PV36P100C01B00	0.5 (70 °C)	25	10 ohm ±10 %	±150
PV36P200C01B00	0.5 (70 °C)	25	20 ohm ±10 %	±150
PV36P500C01B00	0.5 (70 °C)	25	50 ohm ±10 %	±150
PV36P101C01B00	0.5 (70 °C)	25	100 ohm ±10 %	±150
PV36P201C01B00	0.5 (70 °C)	25	200 ohm ±10 %	±100
PV36P501C01B00	0.5 (70 °C)	25	500 ohm ±10 %	±100
PV36P102C01B00	0.5 (70 °C)	25	1k ohm ±10 %	±100
PV36P202C01B00	0.5 (70 °C)	25	2k ohm ±10 %	±100
PV36P502C01B00	0.5 (70 °C)	25	5k ohm ±10 %	±100
PV36P103C01B00	0.5 (70 °C)	25	10k ohm ±10 %	±100
PV36P203C01B00	0.5 (70 °C)	25	20k ohm ±10 %	±100
PV36P253C01B00	0.5 (70 °C)	25	25k ohm ±10 %	±100
PV36P503C01B00	0.5 (70 °C)	25	50k ohm ±10 %	±100
PV36P104C01B00	0.5 (70 °C)	25	100k ohm ±10 %	±100
PV36P204C01B00	0.5 (70 °C)	25	200k ohm ±10 %	±100
PV36P254C01B00	0.5 (70 °C)	25	250k ohm ±10 %	±100
PV36P504C01B00	0.5 (70 °C)	25	500k ohm ±10 %	±100
PV36P105C01B00	0.5 (70 °C)	25	1M ohm ±10 %	±100
PV36P205C01B00	0.5 (70 °C)	25	2M ohm ±10 %	±100

PV36Z100C01B00	0.5 (70 °C)	25	10 ohm ±10 %	±150
PV36Z200C01B00	0.5 (70 °C)	25	20 ohm ±10 %	±150
PV36Z500C01B00	0.5 (70 °C)	25	50 ohm ±10 %	±150
PV36Z101C01B00	0.5 (70 °C)	25	100 ohm ±10 %	±150
PV36Z201C01B00	0.5 (70 °C)	25	200 ohm ±10 %	±100
PV36Z501C01B00	0.5 (70 °C)	25	500 ohm ±10 %	±100
PV36Z102C01B00	0.5 (70 °C)	25	1k ohm ±10 %	±100
PV36Z202C01B00	0.5 (70 °C)	25	2k ohm ±10 %	±100
PV36Z502C01B00	0.5 (70 °C)	25	5k ohm ±10 %	±100
PV36Z103C01B00	0.5 (70 °C)	25	10k ohm ±10 %	±100
PV36Z203C01B00	0.5 (70 °C)	25	20k ohm ±10 %	±100
PV36Z253C01B00	0.5 (70 °C)	25	25k ohm ±10 %	±100
PV36Z503C01B00	0.5 (70 °C)	25	50k ohm ±10 %	±100
PV36Z104C01B00	0.5 (70 °C)	25	100k ohm ±10 %	±100
PV36Z204C01B00	0.5 (70 °C)	25	200k ohm ±10 %	±100
PV36Z254C01B00	0.5 (70 °C)	25	250k ohm ±10 %	±100
PV36Z504C01B00	0.5 (70 °C)	25	500k ohm ±10 %	±100
PV36Z105C01B00	0.5 (70 °C)	25	1M ohm ±10 %	±100
PV36Z205C01B00	0.5 (70 °C)	25	2M ohm ±10 %	±100

Operating Temperature Range: -55 to +125 °C

Soldering Method: Wave (Single and Dual)

**BOURNS®**

Specifications are subject to change without notice.

The device characteristics and parameters in this data sheet can and do vary in different applications and actual device performance may vary over time.

Users should verify actual device performance in their specific applications.

### Standard Mounting Holes

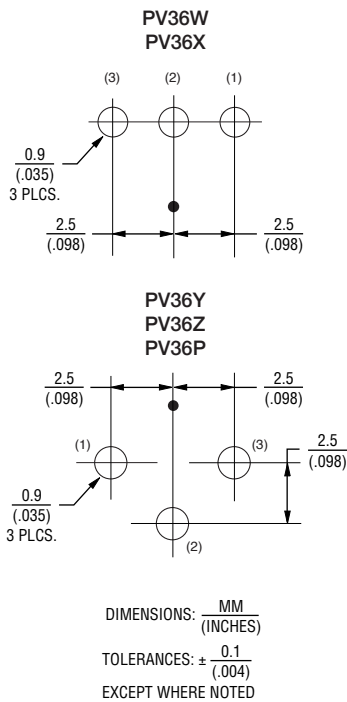

### Characteristics

Temperature Cycle	$\Delta TR$ : $\pm 2\%$ $\Delta V.S.S.$ : $\pm 1\%$
Humidity	$\Delta TR$ : $\pm 2\%$ IR : 100M ohm min.
Vibration (20G)	$\Delta TR$ : $\pm 1\%$ $\Delta V.S.S.$ : $\pm 1\%$
Shock (100G)	$\Delta TR$ : $\pm 1\%$ $\Delta V.S.S.$ : $\pm 1\%$
Temperature Load Life	$\Delta TR$ : $\pm 3\%$ $\Delta V.S.S.$ : $\pm 1\%$
Low Temperature Exposure	$\Delta TR$ : $\pm 2\%$ $\Delta V.S.S.$ : $\pm 1\%$
High Temperature Exposure	$\Delta TR$ : $\pm 3\%$ $\Delta V.S.S.$ : $\pm 1\%$
Rotational Life	$\Delta TR$ : RV 1k ohm, RU500k ohm ... $\pm 5\%$ 1k ohmF RF 500k ohm ... $\pm 3\%$ (200 cycles)

$\Delta TR$  : Total Resistance Change  
 $\Delta V.S.S.$  : Voltage Setting Stability  
IR : Insulation Resistance  
R : Standard Total Resistance

### Part Numbering

Product ID **PV 36 W 103 C01 B00**  
 PV = Trimming Potentiometer  
 Series 36 = Lead Sealed 10 mm Square, 25-Turns  
 Adjustment Direction/Lead Type  
 W = Top, Inline    Y = Top, Triangle  
 X = Side, Inline    Z = Top, Triangle  
 P = Side, Triangle

Total Resistance  
 Expressed by three figures.  
 The first and second figures are significant digits;  
 the third figure expresses the number of zeros  
 that follow.

Resistance (Ohms)	Resistance Code
<b>10</b>	<b>100</b>
<b>20</b>	<b>200</b>
<b>50</b>	<b>500</b>
<b>100</b>	<b>101</b>
<b>200</b>	<b>201</b>
<b>500</b>	<b>501</b>
<b>1,000</b>	<b>102</b>
<b>2,000</b>	<b>202</b>
<b>5,000</b>	<b>502</b>
<b>10,000</b>	<b>103</b>
<b>20,000</b>	<b>203</b>
<b>25,000</b>	<b>253</b>
<b>50,000</b>	<b>503</b>
<b>100,000</b>	<b>104</b>
<b>200,000</b>	<b>204</b>
<b>250,000</b>	<b>254</b>
<b>500,000</b>	<b>504</b>
<b>1,000,000</b>	<b>105</b>
<b>2,000,000</b>	<b>205</b>

Popular values listed in boldface. Special resistances available.

Individual Specification  
 C01 = Standard Type

Packaging  
 B00 = Tube (50 pcs. per tube)

### Typical Part Marking

#### 3-Digit Date Code and Manufacturing Code

- First digit indicates year of manufacture;
- Last two digits indicate week of manufacture;
- 4th digit is suffix for manufacturing location:  
C = Costa Rica

Example:

604C = Manufactured in 2016, week 4, Costa Rica

#### Resistance Code

- Resistance code marking as shown in the Part Numbering Resistance Table.

**BOURNS®**