

Chip Monolithic Ceramic Capacitors for Automotive



2016

Explanation of Symbols in This Catalog



Links are provided to the latest information from the PDF version of the catalog, which is available on the web.

<p>General</p>	<p>For applications that do not require a particular reliability, such as general equipment.</p>	<p>Effective Cap</p>	<p>No DC bias characteristics Polymer capacitor is no capacitance change with DC bias due to aluminum oxidized film for dielectric.</p>																												
<p>Infotainment</p>	<p>Infotainment for Automotive The product for entertainment equipment like car navigations, car audios, and body control equipment like wipers, power windows.</p>	<p>EMI FIL®</p>	<p>Low-inductance product suitable for noise suppression. This product has extremely low ESL and is suitable for suppression of noise, including high frequencies. This product can also be used as a low-ESL, high-performance bypass capacitor.</p>																												
<p>Powertrain</p>	<p>Powertrain/Safety for Automotive Products use for applications (running, turning, stopping, and safety devices) that particularly concern human life, such as in devices for automotive.</p>	<p>Limited to conductive glue mounting</p>	<p>Limited to Conductive Glue Mounting Since silver palladium is used for the external electrodes, the capacitor can be mounted by conductive adhesive.</p>																												
<p>Medical Device</p>	<p>Medical-grade products for Implanted Medical Devices These products are intended for use in implanted medical devices such as cardiac pacemakers, cochlear implants, insulin pumps, and gastric electrostimulators. They are suitable for use in non-critical circuits. *1 *1 Non-critical circuits This term refers to circuits in implanted medical devices that are not directly linked to life support, i.e. circuits that will not directly endanger the life of the patient should the functionality of the device be reduced or halted by failure of the circuit.</p>	<p>D1 Derating 1</p>	<p>Derating 1 This product is suitable when a voltage continuously applied to a capacitor in an operating circuit, is used below (derated) the rated voltage of the capacitor. This model guarantees the test conditions in the endurance test, at a rated voltage x 100% at the maximum operating temperature. A reliability assurance level equivalent to a common product can be secured, by using this product within the voltage and temperature derated conditions recommended in the figure below.</p>																												
<p>AEC-Q200</p>	<p>AEC-Q200 compliant product</p>	<p>D1 Derating 1</p>	<p>Recommended Conditions of the Derating Operating Voltage and Temperature</p> <table border="1"> <caption>Derating 1 Data</caption> <thead> <tr> <th>Product Temperature (°C)</th> <th>125°C Type (%)</th> <th>105°C Type (%)</th> <th>85°C Type (%)</th> </tr> </thead> <tbody> <tr><td>0</td><td>100</td><td>100</td><td>100</td></tr> <tr><td>25</td><td>100</td><td>100</td><td>100</td></tr> <tr><td>50</td><td>100</td><td>100</td><td>100</td></tr> <tr><td>75</td><td>100</td><td>100</td><td>100</td></tr> <tr><td>100</td><td>100</td><td>100</td><td>100</td></tr> <tr><td>125</td><td>70</td><td>70</td><td>70</td></tr> </tbody> </table>	Product Temperature (°C)	125°C Type (%)	105°C Type (%)	85°C Type (%)	0	100	100	100	25	100	100	100	50	100	100	100	75	100	100	100	100	100	100	100	125	70	70	70
Product Temperature (°C)	125°C Type (%)		105°C Type (%)	85°C Type (%)																											
0	100		100	100																											
25	100		100	100																											
50	100	100	100																												
75	100	100	100																												
100	100	100	100																												
125	70	70	70																												
<p>Safety standard</p>	<p>Safety Standard Certified Product Products that acquired safety standard certification IEC60384-14 and products based on the Electrical Appliance and Material Safety Law of Japan.</p>	<p>Derating 2 When the product temperature exceeds 105°C, please use this product within the voltage and temperature derated conditions in the figure below.</p>																													
<p>High Q</p>	<p>Low dissipation for high frequency By devising ceramic materials and electrode materials, low dissipation is achieved in frequency bands of VHF, UHF, and microwave or beyond.</p>	<p>D2 Derating 2</p>	<table border="1"> <caption>Derating 2 Data</caption> <thead> <tr> <th>Product Temperature (°C)</th> <th>Rated Voltage 630V (%)</th> <th>Rated Voltage 450V (%)</th> </tr> </thead> <tbody> <tr><td>0</td><td>630</td><td>450</td></tr> <tr><td>25</td><td>630</td><td>450</td></tr> <tr><td>50</td><td>630</td><td>450</td></tr> <tr><td>75</td><td>630</td><td>450</td></tr> <tr><td>100</td><td>630</td><td>450</td></tr> <tr><td>125</td><td>450</td><td>350</td></tr> </tbody> </table>	Product Temperature (°C)	Rated Voltage 630V (%)	Rated Voltage 450V (%)	0	630	450	25	630	450	50	630	450	75	630	450	100	630	450	125	450	350							
Product Temperature (°C)	Rated Voltage 630V (%)		Rated Voltage 450V (%)																												
0	630		450																												
25	630	450																													
50	630	450																													
75	630	450																													
100	630	450																													
125	450	350																													
<p>Low ESL</p>	<p>Low inductance This capacitor is designed so that the parasitic inductance component (ESL) that the capacitor has on the high frequency side becomes lower.</p>	<p>D3 Derating 3</p>	<p>Derating 3 Please apply the derating curve according to the operating temperature. Please refer to detailed specifications sheet for details.</p>																												
<p>Fail safe</p>	<p>Fail safe product This capacitor is designed to prevent failures as much as possible by short mode.</p>	<p>Deflecting crack</p>	<p>Product resistant to deflection cracking This capacitor is designed to prevent failures as much as possible by short mode caused by cracking when there is board deflection.</p>																												
<p>Soldering crack</p>	<p>Product with solder cracking suppression This capacitor is configured with metal terminals and leads connected to the chip. The metal terminals and leads relieve the stress from expansion and contraction of the solder, to suppress solder cracking.</p>	<p>Anti-noise</p>	<p>Product suitable for acoustic noise reduction and low distortion This product suppresses acoustic noise, which occurs when a ceramic capacitor is used, by devising the materials and configuration.</p>																												

EU RoHS Compliant

- All the products in this catalog comply with EU RoHS.
- EU RoHS is "the European Directive 2011/65/EU on the Restriction of the Use of Certain Hazardous Substances in Electrical and Electronic Equipment."
- For more details, please refer to our website 'Murata's Approach for EU RoHS' (<http://www.murata.com/en-eu/support/compliance/rohs>).

Contents

Product specifications are as of May 2016.

Selection Guide	p2	
Part Numbering	p3	
Capacitance Table	p6	Cap. Table
<hr/>		
AEC-Q200 meeted Monolithic Ceramic Capacitor for Infotainment		
GRT Series	p22	p7
<hr/>		
Monolithic Ceramic Capacitor for Automotive		
GCM Series	p28	p10
<hr/>		
High Effective Capacitance & High Ripple Resistance Monolithic Ceramic Capacitors		
GC3 Series	p36	p14
<hr/>		
Monolithic Ceramic Capacitor Specially Designed to Reduce Shorts		
GCD Series	p38	p14
<hr/>		
Fail Safe Design Monolithic Ceramic Capacitors		
GCE Series	p40	p15
<hr/>		
Monolithic Ceramic Capacitor Limited to Conductive Glue Mounting		
GCG Series	p42	p15
<hr/>		
Resin External Electrode Monolithic Ceramic Capacitors		
GCJ Series	p47	p18
<hr/>		
Metal Terminal Type Monolithic Ceramic Capacitors for Automotive		
KCM Series	p53	p20
<hr/>		
High Effective Capacitance & High Allowable Ripple Current Metal Terminal Type Monolithic Ceramic Capacitor for Automotive		
KC3 Series	p56	p20
<hr/>		
Safety Standard Certified Metal Terminal Type Monolithic Ceramic Capacitors for Automotive		
KCA Series	p59	p20
<hr/>		
3 Terminal Low ESL Monolithic Ceramic Capacitors		
NFM Series	p62	p20
<hr/>		
⚠Caution/Notice/Soldering and Mounting	p64	
Introduction of Website	Catalog	p90
	SimSurfing	p91
	Product Information	p92

Please check the MURATA website (<http://www.murata.com/>) if you cannot find a part number in this catalog.

Selection Guide for Capacitors

			AEC-Q200	Safety standard	High Q	Low ESL	Anti-noise	Fail safe	Deflecting crack	Soldering crack	Effective Cap	EMI FIL®	Other	
Info-tainment	GRT	P22												
	GCM	P28												
Power-train	GC3	P36												
	GCD	P38												
	GCE	P40												
	GCG	P42											Limited to conductive glue mounting	
	GCJ	P47												
	KCM	P53												
	KC3	P56												
	KCA	P59												
	NFM	P62												
	DE6	WEB												
	RCE	WEB												
	RH	WEB												
	General	GRM	WEB											
GRM		WEB											For LED backlight only	
GA2		WEB												
GA3		WEB												
GJM		WEB												
GMA		WEB											Wire bondable	
GMD		WEB											Wire bondable	
GQM		WEB												
GR3		WEB												
GR4		WEB											For communication / information devices	
GR7		WEB											Limited to camera flashes	
GRJ		WEB												
KR3		WEB												
KRM		WEB												
LLA		WEB												
LLL		WEB												
LLM		WEB												
LLR		WEB												
NFM		WEB												
DE1		WEB												
DE2		WEB												
DEJ		WEB												
DHR		WEB												
RDE		WEB												
DHK		WEB												
DHS		WEB												
ECAS	WEB													
Medical Device	GCH	WEB											For Implanted Medical Devices	

● Part Numbering

Chip Monolithic Ceramic Capacitors for Automotive



(Part Number)

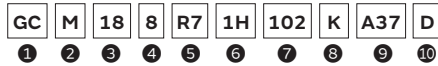

① Product ID

② Series

Product ID	Code	Series
GC	3	High effective capacitance & High allowable ripple current
	D	Specially designed product to reduce shorts
	E	Specially designed product to reduce shorts & resin electrode product
	G	Limited to conductive glue mounting
	J	Soft termination type
	M	For automotive
GR	T	Meet AEC-Q200 for infotainment
KC	3	Metal terminal type/High effective capacitance & High allowable ripple current
	A	Metal terminal type/ Safety standard certified product
	M	Metal terminal type

③ Chip Dimension (L x W)

Code	Dimension (L x W)	EIA
03	0.6 x 0.3mm	0201
15	1.0 x 0.5mm	0402
18	1.6 x 0.8mm	0603
21	2.0 x 1.25mm	0805
31	3.2 x 1.6mm	1206
32	3.2 x 2.5mm	1210
43	4.5 x 3.2mm	1812
55	5.7 x 5.0mm	2220

⑤ Temperature Characteristics

Temperature Characteristic Codes			Temperature Characteristics			Operating Temperature Range	Capacitance Change Each Temperature (%)					
Code	Public STD Code	Reference Temperature	Temperature Range	Capacitance Change or Temperature Coefficient	-55°C		*4		-10°C			
					Max.		Min.	Max.	Min.	Max.	Min.	
5C	COG	EIA	25°C	25 to 125°C	0±30ppm/°C	-55 to 125°C	0.58	-0.24	0.4	-0.17	0.25	-0.11
5G	X8G	*2	25°C	25 to 150°C	0±30ppm/°C	-55 to 150°C	0.58	-0.24	0.4	-0.17	0.25	-0.11
7U	U2J	EIA	25°C	25 to 125°C *3	-750±120ppm/°C	-55 to 125°C	8.78	5.04	6.04	3.47	3.84	2.21
9E	ZLM	*2	20°C	-55 to -40°C	-4700+1000/-2500ppm/°C	-55 to 125°C	-	-	-	-	-	-
				-40 to 20°C	-5350±750ppm/°C		-	-	-	-	-	
				20 to 85°C	-4700±500ppm/°C		-	-	-	-	-	
				85 to 125°C	-4700+2000/-1000ppm/°C		-	-	-	-	-	
C7	X7S	EIA	25°C	-55 to 125°C	±22%	-55 to 125°C	-	-	-	-	-	-
C8	X6S	EIA	25°C	-55 to 105°C	±22%	-55 to 105°C	-	-	-	-	-	-
D7	X7T	EIA	25°C	-55 to 125°C	+22%, -33%	-55 to 125°C	-	-	-	-	-	-
L8	X8L	*2	25°C	-55 to 150°C	+15%, -40%	-55 to 150°C	-	-	-	-	-	-
R6	X5R	EIA	25°C	-55 to 85°C	±15%	-55 to 85°C	-	-	-	-	-	-
R7	X7R	EIA	25°C	-55 to 125°C	±15%	-55 to 125°C	-	-	-	-	-	-
R9	X8R	EIA	25°C	-55 to 150°C	±15%	-55 to 150°C	-	-	-	-	-	-

*1 Capacitance change is specified with 50% rated voltage applied.

*2 Murata Temperature Characteristic Code.

*3 Rated Voltage 100Vdc max: 25 to 85°C

*4 -25°C (Reference Temperature 20°C) / -30°C (Reference Temperature 25°C)

④ Height Dimension (T) (Except KC□)

Code	Dimension (T)
3	0.3mm
5	0.5mm
6	0.6mm
8	0.8mm
9	0.85mm
A	1.0mm
B	1.25mm
C	1.6mm
D	2.0mm
E	2.5mm
M	1.15mm
Q	1.5mm
X	Depends on individual standards.

④ Height Dimension (T) (KC□ Only)

Code	Dimension (T)
L	2.8mm
Q	3.7mm
T	4.8mm
W	6.4mm

Continued on the following page. ↗

(Part Number)

GC	M	18	8	R7	1H	102	K	A37	D
1	2	3	4	5	6	7	8	9	10

Continued from the preceding page. ↘

⑥ Rated Voltage

Code	Rated Voltage
0E	DC2.5V
0G	DC4V
0J	DC6.3V
1A	DC10V
1C	DC16V
1E	DC25V
YA	DC35V
1H	DC50V
1J	DC63V
1K	DC80V
2A	DC100V
2E	DC250V
2W	DC450V
2J	DC630V
3A	DC1kV
MF	X1/Y2: AC250V (Safety Standard Certified Type MF)

⑦ Capacitance

Expressed by three-digit alphanumerics. The unit is pico-farad (pF). The first and second figures are significant digits, and the third figure expresses the number of zeros that follow the two numbers.

If there is a decimal point, it is expressed by the capital letter "R."
 In this case, all figures are significant digits.

If any letter, other than "R" is included, this indicates the specific part number is a non-standard part.

Ex.)

Code	Capacitance
R50	0.50pF
1R0	1.0pF
100	10pF
103	10000pF

⑧ Capacitance Tolerance

Code	Capacitance Tolerance
C	±0.25pF
D	±0.5pF
J	±5%
K	±10%
M	±20%

⑨ Individual Specification Code

Expressed by three figures.

⑩ Package

Code	Package
L	ø180mm Embossed Taping
D/W	ø180mm Paper Taping
K	ø330mm Embossed Taping
J	ø330mm Paper Taping
B	Bulk
C	Bulk Case

Please contact us if you find any part number not provided in this table.

3 Terminal Low ESL Monolithic Ceramic Capacitors



(Part Number)

NF	M	3D	CC	102	R	1H	3	L
1	2	3	4	5	6	7	8	9

1 Product ID 2 Series

Product ID	Series
NFM	3 Terminal Low ESL Type

3 Dimensions (LxW)

Code	Dimensions (LxW)	EIA
21	2.0x1.25mm	0805
31	3.2x1.6mm	1206

4 Features

Code	Features	
HC	Powertrain/Safety for Automotive	For Signal Lines / For Large Current
HK		For Very Large Current

5 Capacitance

Expressed by three figures. The unit is in pico-farad (pF). The first and second figures are significant digits, and the third figure expresses the number of zeros that follow the two figures.

6 Characteristics

Code	Capacitance Temperature Characteristics
R	±15%, +15/-18%

7 Rated Voltage

Code	Rated Voltage
1A	10V
1C	16V
1H	50V
2A	100V

8 Electrode

Code	Electrode
3	Sn Plating

9 Packaging

Code	Packaging
B	Bulk
L	Embossed Taping (ø180mm Reel)
D	Paper Taping (ø180mm Reel)

Please contact us if you find any part number not provided in this table.

Capacitance Table

How to read the Capacitance Table

L×W (mm)	1.0×0.5			1.6×	
T max. (mm)	0.55			0.9	
Rated Voltage (Vdc)	100	50	25	100	50
Cap. / TC Code	COG	COG	COG	COG	COG
1.0pF	p23	p23		p23	p2
2.0pF	p23	p23		p23	p2
3.0pF	p23	p23		p23	p2
4.0pF	p23	p23		p23	p2
5.0pF	p23	p23		p23	p2

→ The values can be narrowed down in the order of size, rated voltage, and temperature characteristics.

→ Refers to the page of the part number list.
 Check the part number list for the applicable product number.

Temperature Characteristics Table

The Table is colored by temperature characteristic codes. Refer to the following Table for the meaning of each code.

Temperature Characteristic Codes		Temperature Characteristics			Operating Temperature Range	Capacitance Change Each Temperature (%)					
Public STD Code	Reference Temperature	Temperature Range	Capacitance Change or Temperature Coefficient	-55°C		*3		-10°C			
				Max.		Min.	Max.	Min.	Max.	Min.	
COG	EIA	25°C	25 to 125°C	0±30ppm/°C	-55 to 125°C	0.58	-0.24	0.4	-0.17	0.25	-0.11
X8G	*1	25°C	25 to 150°C	0±30ppm/°C	-55 to 150°C	0.58	-0.24	0.4	-0.17	0.25	-0.11
U2J	EIA	25°C	25 to 125°C *2	-750±120ppm/°C	-55 to 125°C	8.78	5.04	6.04	3.47	3.84	2.21
ZLM	*1	20°C	-55 to -40°C	-4700+1000/-2500ppm/°C	-55 to 125°C	-	-	-	-	-	-
			-40 to 20°C	-5350±750ppm/°C		-	-	-	-	-	-
			20 to 85°C	-4700±500ppm/°C		-	-	-	-	-	-
			85 to 125°C	-4700+2000/-1000ppm/°C		-	-	-	-	-	-
X7S	EIA	25°C	-55 to 125°C	±22%	-55 to 125°C	-	-	-	-	-	-
X6S	EIA	25°C	-55 to 105°C	±22%	-55 to 105°C	-	-	-	-	-	-
X7T	EIA	25°C	-55 to 125°C	+22%, -33%	-55 to 125°C	-	-	-	-	-	-
X8L	*1	25°C	-55 to 150°C	+15%, -40%	-55 to 150°C	-	-	-	-	-	-
X5R	EIA	25°C	-55 to 85°C	±15%	-55 to 85°C	-	-	-	-	-	-
X7R	EIA	25°C	-55 to 125°C	±15%	-55 to 125°C	-	-	-	-	-	-
X8R	EIA	25°C	-55 to 150°C	±15%	-55 to 150°C	-	-	-	-	-	-

*1 Murata Temperature Characteristic Code.

*2 Rated Voltage 100Vdc max: 25 to 85°C

*3 -25°C (Reference Temperature 20°C) / -30°C (Reference Temperature 25°C)

Capacitance Table

p00 Each number in the Part Number List refers to the page number printed at the bottom of the page.

GRT Series Temperature Compensating Type

p00 ← Part Number List EIA: COG

L×W (mm)	1.0×0.5			1.6×0.8			2.0×1.25	3.2×1.6		
T max. (mm)	0.55			0.9			1.35	1.8		
Rated Voltage (Vdc)	100	50	25	100	50	25	50	50	25	16
Cap. / TC Code	COG	COG	COG	COG	COG	COG	COG	COG	COG	COG
1.0pF	p23	p23		p23	p24					
2.0pF	p23	p23		p23	p24					
3.0pF	p23	p23		p23	p24					
4.0pF	p23	p23		p23	p24					
5.0pF	p23	p23		p23	p24					
6.0pF	p23	p23		p23	p24					
7.0pF	p23	p23		p23	p24					
8.0pF	p23	p23		p23	p24					
9.0pF	p23	p23		p23	p24					
10pF	p23	p23	p23	p23	p24					
12pF	p23	p23	p23	p23	p24					
15pF	p23	p23	p23	p23	p24					
18pF	p23	p23	p23	p23	p24					
22pF	p23	p23	p23	p23	p24					
27pF	p23	p23	p23	p23	p24					
33pF	p23	p23	p23	p23	p24					
39pF	p23	p23	p23	p23	p24					
47pF	p23	p23	p23	p23	p24					
56pF	p23	p23	p23	p23	p24					
68pF	p23	p23	p23	p23	p24					
82pF	p23	p23	p23	p24	p24					
100pF	p23	p23	p23	p24	p24					
120pF		p23	p23	p24	p24					
150pF		p23	p23	p24	p24					
180pF		p23	p23	p24	p24					
220pF		p23	p23	p24	p24					
270pF		p23	p23	p24	p24					
330pF		p23	p23	p24	p24					
390pF		p23	p23	p24	p24					
470pF		p23	p23	p24	p24					
560pF		p23	p23	p24	p24	p24				
680pF		p23	p23	p24	p24	p24				
820pF		p23	p23	p24	p24	p24				
1000pF		p23	p23	p24	p24	p24				
1200pF				p24	p24	p24				
1500pF				p24	p24	p24				
1800pF				p24						
2200pF				p24						
2700pF				p24						
3300pF				p24						
3900pF				p24						
4700pF				p24	p24					
5600pF				p24	p24					
6800pF				p24	p24	p24				
8200pF				p24	p24	p24				
10000pF				p24	p24	p24				
18000pF						p24				
22000pF						p24				
47000pF										
56000pF								p24		
68000pF								p24		
82000pF								p24		
0.10μF								p24	p24	
0.12μF									p24	p24

Capacitance Table

p00 Each number in the Part Number List refers to the page number printed at the bottom of the page.

GRT Series High Dielectric Constant Type

p00 ← Part Number List EIA: X6S X7S X5R X7R

L×W (mm)	0.6×0.3														1.0×0.5											
	0.33														0.35		0.55									
T max. (mm)	0.33														0.35		0.55									
Rated Voltage (Vdc)	35		25		16		10		6.3		4		6.3		4		50		35		25		16		10	
Cap. / TC Code	X5R	X7R	X6S	X5R	X6S	X5R	X7R	X6S	X5R	X7R	X6S	X5R	X6S	X5R	X5R	X7R	X6S	X5R	X7R	X6S	X5R	X7R	X6S	X5R	X7R	X6S
100pF				p25																						
220pF				p25														p25								
470pF		p25	p25	p25														p25								
1000pF		p25	p25	p25														p25								
2200pF								p25	p25	p25								p25								
4700pF				p25				p25	p25	p25								p25								
10000pF				p25		p25	p25	p25	p25	p25								p25		p25			p25			
22000pF					p25			p25		p25	p25							p25		p25			p25			
47000pF					p25			p25		p25	p25							p25		p25			p25			
0.10μF	p25		p25	p25	p25	p25		p25	p25	p25	p25							p25		p25			p25			
0.22μF								p25		p25	p25	p25						p25	p25		p25	p25	p25		p25	p25
0.47μF												p25							p25			p25	p25	p25		
1.0μF													p25	p25							p25			p25		p25
2.2μF																										
4.7μF																										
10μF																										
22μF																										
33μF																										
47μF																										
100μF																										

Continued to the following table. ↗

L×W (mm)	1.0×0.5														1.6×0.8																	
	0.55				0.6				0.7						0.9																	
T max. (mm)	0.55				0.6				0.7						0.9																	
Rated Voltage (Vdc)	10		6.3		4		35		25		16		10		6.3		4		25		16		10		50		35		25		16	
Cap. / TC Code	X5R	X7R	X6S	X5R	X7R	X5R	X6S	X6S	X7S	X5R	X5R	X5R	X6S	X5R	X7S	X6S	X6S	X7R	X7R	X5R	X6S	X5R	X7R	X6S	X5R	X7R	X6S	X5R	X7R	X6S		
100pF																																
220pF																																
470pF																											p26					
1000pF																											p26					
2200pF																											p26					
4700pF																											p26					
10000pF																											p26	p26				
22000pF			p25																								p26					
47000pF																											p26					
0.10μF																																
0.22μF	p25		p25	p25																										p26		
0.47μF	p25		p25	p25																									p26	p26		
1.0μF	p25	p25	p25	p25	p25	p25	p25	p25																			p26	p26	p26	p26		
2.2μF	p25		p25	p25																									p26	p26		
4.7μF																																
10μF																																
22μF																																
33μF																																
47μF																																
100μF																																

Continued on the following page. ↗

Capacitance Table

p00 Each number in the Part Number List refers to the page number printed at the bottom of the page.

(→ GRT Series High Dielectric Constant Type)

p00 ← Part Number List EIA: X6S X7S X5R X7R

L×W (mm)	1.6×0.8																2.0×1.25						
	0.9								0.95				1.0				1.35						
T max. (mm)	0.9								0.95				1.0				1.35						
Rated Voltage (Vdc)	16	10	6.3	4	25	16	10	50	35	25	16	10	100	50	25	16	100	50	25	16			
Cap. / TC Code	X6S	X5R	X6S	X5R	X7R	X6S	X5R	X6S	X5R	X5R	X6S	X5R	X5R	X6S	X5R	X6S	X6S	X7R	X7R	X6S	X5R	X7R	X6S
100pF																							
220pF																							
470pF																							
1000pF																							
2200pF																							
4700pF																							
10000pF																							
22000pF																							
47000pF																							
0.10μF																							
0.22μF																							
0.47μF																							
1.0μF	p26	p26	p26	p26																			
2.2μF	p26																						
4.7μF																							
10μF																							
22μF																							
33μF																							
47μF																							
100μF																							

Continued to the following table. ↗

L×W (mm)	2.0×1.25																3.2×1.6									
	1.35				1.4								1.45				1.8									
T max. (mm)	1.35				1.4								1.45				1.8									
Rated Voltage (Vdc)	16	10	6.3	50	35	25	16	10	6.3	25	16	10	6.3	4	50	35	25	50	35	25						
Cap. / TC Code	X5R	X6S	X5R	X5R	X5R	X6S	X7R	X6S	X5R	X7R	X7R	X5R	X7R	X5R	X5R	X5R	X6S	X5R	X5R	X7R	X6S	X5R	X6S	X5R	X7R	X6S
100pF																										
220pF																										
470pF																										
1000pF																										
2200pF																										
4700pF																										
10000pF																										
22000pF																										
47000pF																										
0.10μF																										
0.22μF																										
0.47μF																										
1.0μF																										
2.2μF	p26																									
4.7μF	p26																									
10μF	p26	p26	p26	p26																						
22μF																										
33μF																										
47μF																										
100μF																										

Continued on the following page. ↗

Capacitance Table

p00 Each number in the Part Number List refers to the page number printed at the bottom of the page.

(→ GRT Series High Dielectric Constant Type)

p00 ← Part Number List EIA: X6S X7S X5R X7R

L×W (mm)	3.2×1.6										3.2×2.5														
	1.8										2.2					2.7									
T max. (mm)	1.8										2.2					2.7									
Rated Voltage (Vdc)	25	16		10		6.3		4		25	16		10		6.3		50	25	16	10	6.3				
Cap. / TC Code	X5R	X7R	X6S	X5R	X7R	X6S	X5R	X7R	X6S	X5R	X6S	X5R	X6S	X5R	X6S	X5R	X7R	X6S	X5R	X6S	X5R	X6S	X7R	X6S	X5R
100pF																									
220pF																									
470pF																									
1000pF																									
2200pF																									
4700pF																									
10000pF																									
22000pF																									
47000pF																									
0.10μF																									
0.22μF																									
0.47μF																									
1.0μF																									
2.2μF																									
4.7μF	p27	p27	p27	p27													p27	p27	p27						
10μF	p27		p27	p27	p27	p27	p27			p27		p27	p27	p27	p27										
22μF	p27		p27	p27		p27	p27	p27	p27	p27				p27		p27	p27			p27		p27			
33μF																p27									
47μF							p27		p27	p27	p27										p27	p27	p27	p27	
100μF																									p27

Capacitance Table

p00 Each number in the Part Number List refers to the page number printed at the bottom of the page.

GCM Series Temperature Compensating Type

p00 ← Part Number List EIA: C0G U2J Murata Temperature Characteristic: X8G ZLM

L×W (mm)	0.6×0.3		1.0×0.5		1.6×0.8				2.0×1.25								3.2×1.6												
	T max. (mm)	0.33	0.55	0.9				0.7		0.95			1.0	1.4		1.45	0.95			1.0									
Rated Voltage (Vdc)	25	50	100	50	100	50	100	80	63	50	250	80	63	50	250	100	80	63	50	1000	630								
Cap. / TC Code	COG	COG	X8G	COG	U2J	COG	U2J	COG	COG	ZLM	COG	COG	COG	U2J	COG	COG	COG	COG	U2J	COG	COG	COG	COG	U2J	COG	U2J			
1.0pF	p29	p29	p29	p29		p30																							
2.0pF	p29	p29	p29	p29		p30																							
3.0pF	p29	p29	p29	p29		p30																							
4.0pF	p29	p29	p29	p29		p30																							
5.0pF	p29	p29	p29	p29		p30																							
6.0pF	p29	p29		p29		p30																							
7.0pF	p29	p29		p29		p30																							
8.0pF	p29	p29		p29		p30																							
9.0pF	p29	p29		p29		p30																							
10pF	p29	p29		p29		p30																							
12pF	p29	p29	p29	p29		p30																							
15pF	p29	p29	p29	p30		p30																							
18pF	p29	p29	p29	p30		p30																							
22pF	p29	p29	p29	p30		p30																							
27pF	p29	p29	p29	p30		p30																							
33pF	p29	p29	p29	p30		p30																							
39pF	p29	p29	p29	p30		p30																							
47pF	p29	p29	p29	p30		p30																							
56pF	p29	p29	p29	p30		p30																							
68pF	p29	p29	p29	p30		p30																							
82pF	p29	p29	p29	p30		p30																							
100pF	p29	p29	p29	p30		p30																							
120pF		p29	p29	p30		p30																							
150pF		p29	p29	p30		p30																							
180pF		p29	p29	p30		p30																							
220pF		p29	p29	p30		p30																							
270pF		p29	p29	p30		p30																							
330pF		p29	p29	p30		p30																							
390pF		p29	p29	p30		p30																							
470pF		p29	p29	p30		p30																							
560pF		p29	p29	p30		p30																							
680pF		p29	p29	p30		p30																							
820pF		p29	p29	p30		p30																							
1000pF		p29	p29	p30	p30	p30	p30	p31	p31	p31																			
1100pF																													
1200pF				p30	p30	p30	p30	p31	p31	p31																			
1300pF																													
1500pF				p30	p30	p30	p30	p31	p31	p31																			
1800pF					p30	p30	p30	p31	p31																				
2200pF					p30	p30	p30	p31	p31																				
2700pF					p30	p30	p30	p31	p31																				
3300pF					p30	p30	p30	p31	p31																				
3900pF					p30	p30	p30		p31																				
4700pF					p30		p30		p31																				
5600pF					p30		p30			p31																			
6800pF					p30		p30			p31																			
8200pF					p30		p30			p31																			
10000pF					p30		p30			p31																			
12000pF																													
15000pF																													
18000pF																													
20000pF																													
22000pF																													
27000pF																													
33000pF																													
39000pF																													
47000pF																													
56000pF																													
68000pF																													
75000pF																													
82000pF																													
91000pF																													
0.10μF																													

Continued on the following page. ↗

Capacitance Table

p00 Each number in the Part Number List refers to the page number printed at the bottom of the page.

(→ GCM Series Temperature Compensating Type)

p00 ← Part Number List EIA: C0G U2J Murata Temperature Characteristic: X8G ZLM

L×W (mm)	3.2×1.6										3.2×2.5						4.5×3.2												
	1.0		1.25				1.8				1.0	1.25		1.5		2.0		1.5		2.0									
T max. (mm)	250		1000		630		250		50		1000		630		250		50		630		1000		630		1000		630		
Rated Voltage (Vdc)	250		1000		630		250		50		1000		630		250		50		630		1000		630		1000		630		
Cap. / TC Code	COG	U2J	COG	U2J	COG	U2J	COG	U2J	COG	U2J	COG	U2J	COG	U2J	COG	U2J	COG	U2J	COG	U2J	COG	U2J	COG	U2J	COG	U2J	COG	U2J	
1.0pF																													
2.0pF																													
3.0pF																													
4.0pF																													
5.0pF																													
6.0pF																													
7.0pF																													
8.0pF																													
9.0pF																													
10pF		p32																											
12pF		p32																											
15pF		p32																											
18pF		p32																											
22pF		p32																											
27pF		p32																											
33pF		p32																											
39pF		p32																											
47pF		p32																											
56pF		p32																											
68pF		p32																											
82pF		p32																											
100pF		p32																											
120pF		p32																											
150pF		p32																											
180pF		p32																											
220pF		p32																											
270pF		p32																											
330pF		p32																											
390pF		p32																											
470pF		p32																											
560pF		p32																											
680pF		p32																											
820pF		p32																											
1000pF		p33																											
1100pF																													
1200pF		p33																											
1300pF																													
1500pF		p33																											
1800pF		p33																											
2200pF		p33																											
2700pF		p33																											
3300pF		p33																											
3900pF		p33																											
4700pF		p33																											
5600pF		p33																											
6800pF		p33																											
8200pF																													
10000pF																													
12000pF																													
15000pF																													
18000pF																													
20000pF																													
22000pF																													
27000pF																													
33000pF																													
39000pF																													
47000pF																													
56000pF																													
68000pF																													
75000pF																													
82000pF																													
91000pF																													
0.10μF																													

Continued on the following page. ↗

Capacitance Table

p00 Each number in the Part Number List refers to the page number printed at the bottom of the page.

(→ GCM Series Temperature Compensating Type)

p00 ← Part Number List EIA: **C0G** **U2J** Murata Temperature Characteristic: **X8G** **ZLM**

L×W (mm)	5.7×5.0			
	1.5		2.0	
T max. (mm)	1.5		2.0	
Rated Voltage (Vdc)	1000	630	1000	630
Cap. / TC Code	U2J	U2J	U2J	U2J
1.0pF				
2.0pF				
3.0pF				
4.0pF				
5.0pF				
6.0pF				
7.0pF				
8.0pF				
9.0pF				
10pF				
12pF				
15pF				
18pF				
22pF				
27pF				
33pF				
39pF				
47pF				
56pF				
68pF				
82pF				
100pF				
120pF				
150pF				
180pF				
220pF				
270pF				
330pF				
390pF				
470pF				
560pF				
680pF				
820pF				
1000pF				
1100pF				
1200pF				
1300pF				
1500pF				
1800pF				
2200pF				
2700pF				
3300pF				
3900pF				
4700pF				
5600pF	p33			
6800pF	p33			
8200pF		p33		
10000pF		p33		
12000pF				
15000pF				
18000pF				
20000pF				
22000pF				
27000pF	p33			
33000pF			p33	
39000pF			p33	
47000pF			p33	
56000pF				
68000pF				
75000pF				
82000pF				
91000pF				
0.10μF				

Capacitance Table

p00 Each number in the Part Number List refers to the page number printed at the bottom of the page.

GCM Series High Dielectric Constant Type

p00 ← Part Number List EIA: X7S X7R

L×W (mm)	0.6×0.3			1.0×0.5					1.6×0.8					2.0×1.25												
	0.33			0.55		0.6	0.7	0.9					0.7	0.95				1.4								
T max. (mm)	25	16	10	100	50	25	16	10	10	100	50	25	16	6.3	100	100	50	25	16	100	50	35	25	16	10	
Rated Voltage (Vdc)	X7R	X7R	X7R	X7R	X7R	X7R	X7R	X7S	X7S	X7R	X7R	X7R	X7R	X7R	X7R	X7R	X7R	X7R	X7R	X7R	X7R	X7R	X7R	X7R	X7R	X7R
Cap. / TC Code	X7R	X7R	X7R	X7R	X7R	X7R	X7R	X7S	X7S	X7R	X7R	X7R	X7R	X7R	X7R	X7R	X7R	X7R	X7R	X7R	X7R	X7R	X7R	X7R	X7R	X7R
100pF	p34																									
150pF	p34																									
220pF	p34			p34	p34																					
330pF	p34			p34	p34																					
470pF	p34			p34	p34																					
680pF	p34			p34	p34																					
1000pF	p34			p34	p34					p34	p34															
1500pF	p34			p34	p34					p34	p34															
2200pF		p34		p34	p34					p34	p34															
3300pF		p34		p34	p34					p34	p34															
4700pF			p34	p34	p34					p34	p34															
6800pF			p34		p34					p34	p34				p34											
10000pF			p34		p34	p34				p34	p34				p34											
15000pF					p34	p34				p34	p34				p34											
22000pF					p34	p34				p34	p34				p34											
33000pF					p34	p34	p34				p34	p34					p35	p35								
47000pF					p34	p34	p34				p34	p34										p35	p35			
68000pF					p34		p34				p34	p34										p35	p35			
0.10μF					p34		p34				p34	p34	p34									p35	p35			
0.15μF							p34				p34	p34										p35			p35	
0.22μF							p34				p34	p34										p35			p35	
0.33μF													p34					p35							p35	
0.47μF								p34				p34	p34					p35				p35				
0.68μF									p34									p35			p35		p35		p35	
1.0μF									p34			p34	p34					p35			p35	p35	p35	p35		
1.5μF																					p35		p35	p35		
2.2μF														p34									p35	p35	p35	p35
4.7μF																								p35		p35
10μF																									p35	
22μF																										
47μF																										

Continued on the following page. ↗

Capacitance Table

p00 Each number in the Part Number List refers to the page number printed at the bottom of the page.

(→ GCM Series High Dielectric Constant Type)

p00 ← Part Number List EIA: X7S X7R

L×W (mm)	2.0×1.25				3.2×1.6										3.2×2.5											
	1.4	1.45			0.95	1.25	1.3	1.8						1.9	2.2			2.7								
Rated Voltage (Vdc)	6.3	100	35	25	100	100	50	25	100	50	25	16	10	6.3	25	100	25	16	50	35	25	16	10	6.3		
Cap. / TC Code	X7R	X7S	X7S	X7S	X7R	X7R	X7R	X7R	X7S	X7R	X7S	X7R	X7R	X7R	X7S	X7S	X7R	X7R	X7R	X7S	X7S	X7R	X7R	X7R	X7R	
100pF																										
150pF																										
220pF																										
330pF																										
470pF																										
680pF																										
1000pF																										
1500pF																										
2200pF																										
3300pF																										
4700pF																										
6800pF																										
10000pF																										
15000pF																										
22000pF																										
33000pF																										
47000pF																										
68000pF																										
0.10μF					p35																					
0.15μF						p35																				
0.22μF						p35																				
0.33μF							p35																			
0.47μF							p35																			
0.68μF							p35																			
1.0μF		p35					p35																			
1.5μF																										
2.2μF								p35																		
4.7μF			p35	p35																						
10μF	p35																									
22μF																										
47μF																										p35

Capacitance Table

p00 Each number in the Part Number List refers to the page number printed at the bottom of the page.

GC3 Series High Dielectric Constant Type

p00 ← Part Number List EIA: X7T

L×W (mm)	2.0×1.25		3.2×1.6						3.2×2.5				4.5×3.2				5.7×5.0					
	1.0	1.45	1.0	1.25		1.8		1.5	2.0		1.5	2.0		2.0		2.7						
T max. (mm)	1.0	1.45	1.0	1.25	1.25	1.8	1.8	1.5	2.0	2.0	1.5	2.0	2.0	2.0	2.7	2.7						
Rated Voltage (Vdc)	250	250	450	250	630	450	250	630	450	250	630	250	630	450	250	630	450	250	630	250		
Cap. / TC Code	X7T	X7T	X7T	X7T	X7T	X7T	X7T	X7T	X7T	X7T	X7T	X7T	X7T	X7T	X7T	X7T	X7T	X7T	X7T	X7T	X7T	
10000pF	p37		p37		p37																	
15000pF	p37		p37				p37															
22000pF		p37			p37				p37													
33000pF			p37		p37					p37												
47000pF						p37		p37			p37											
68000pF									p37			p37			p37							
0.10μF										p37		p37							p37			
0.15μF													p37		p37				p37			
0.22μF														p37					p37		p37	
0.33μF															p37				p37			
0.47μF																p37			p37	p37		
0.68μF																				p37		
1.0μF																						p37

GCD Series High Dielectric Constant Type

p00 ← Part Number List EIA: X7R

L×W (mm)	1.6×0.8			2.0×1.25				
	0.9			0.7	0.95	1.4		
T max. (mm)	100	50	25	100	50	100	100	50
Rated Voltage (Vdc)	100	50	25	100	50	100	100	50
Cap. / TC Code	X7R	X7R	X7R	X7R	X7R	X7R	X7R	X7R
1000pF	p39	p39		p39	p39			
1200pF	p39	p39		p39	p39			
1500pF	p39	p39		p39	p39			
1800pF	p39	p39		p39	p39			
2200pF	p39	p39		p39	p39			
2700pF	p39	p39		p39	p39			
3300pF	p39	p39		p39	p39			
3900pF	p39	p39		p39	p39			
4700pF	p39	p39		p39	p39			
5600pF	p39	p39		p39	p39			
6800pF	p39	p39				p39		
8200pF	p39	p39					p39	
10000pF	p39	p39					p39	
12000pF	p39	p39					p39	
15000pF	p39	p39					p39	p39
18000pF	p39	p39					p39	p39
22000pF	p39	p39					p39	p39
27000pF			p39				p39	p39
33000pF			p39				p39	p39
39000pF			p39				p39	p39
47000pF			p39				p39	p39
56000pF							p39	p39
68000pF							p39	p39
82000pF							p39	p39
0.10μF							p39	p39

Capacitance Table

p00 Each number in the Part Number List refers to the page number printed at the bottom of the page.

GCE Series High Dielectric Constant Type

p00 ← Part Number List EIA: X7R

L×W (mm)	1.6×0.8			2.0×1.25				
	0.9			0.7	0.95	1.45		
T max. (mm)								
Rated Voltage (Vdc)	100	50	25	100	50	100	100	50
Cap. / TC Code	X7R	X7R	X7R	X7R	X7R	X7R	X7R	X7R
220pF						p41		
270pF						p41		
330pF						p41		
390pF						p41		
470pF						p41		
560pF						p41		
680pF						p41		
820pF						p41		
1000pF	p41	p41		p41	p41			
1200pF	p41	p41		p41	p41			
1500pF	p41	p41		p41	p41			
1800pF	p41	p41		p41	p41			
2200pF	p41	p41		p41	p41			
2700pF	p41	p41		p41	p41			
3300pF	p41	p41		p41	p41			
3900pF	p41	p41		p41	p41			
4700pF	p41	p41		p41	p41			
5600pF	p41	p41		p41	p41			
6800pF	p41	p41				p41		
8200pF	p41	p41					p41	
10000pF	p41	p41					p41	
12000pF	p41	p41					p41	
15000pF	p41	p41					p41	p41
18000pF	p41	p41					p41	p41
22000pF	p41	p41					p41	p41
27000pF			p41				p41	p41
33000pF			p41				p41	p41
39000pF			p41				p41	p41
47000pF			p41				p41	p41
56000pF							p41	p41
68000pF							p41	p41
82000pF							p41	p41
0.10μF							p41	p41

GCG Series Temperature Compensating Type

p00 ← Part Number List Murata Temperature Characteristic: X8G

L×W (mm)	1.0×0.5	1.6×0.8	2.0×1.25	
	0.55	0.9	0.7	0.95
T max. (mm)				
Rated Voltage (Vdc)	50	50	50	50
Cap. / TC Code	X8G	X8G	X8G	X8G
10pF		p43		
12pF		p43		
15pF		p43		
18pF		p43		
22pF		p43		
27pF		p43		
33pF		p43		
39pF		p43		
47pF		p43		
56pF		p43		
68pF		p43		
82pF		p43		
100pF		p43	p43	
120pF	p43	p43	p43	
150pF	p43	p43	p43	
180pF	p43	p43	p43	
220pF	p43	p43	p43	
270pF	p43	p43	p43	
330pF	p43	p43	p43	
390pF	p43	p43	p43	
470pF	p43	p43	p43	
560pF		p43	p43	
680pF		p43	p43	
820pF		p43	p43	
1000pF		p43	p43	
1200pF		p43	p43	
1500pF		p43	p43	
1800pF		p43	p43	
2200pF		p43	p43	
2700pF			p43	
3300pF			p43	
3900pF			p43	
4700pF			p43	
5600pF				p43
6800pF				p43
8200pF				p43
10000pF				p43

Capacitance Table

p00 Each number in the Part Number List refers to the page number printed at the bottom of the page.

GCG Series High Dielectric Constant Type

p00 ← Part Number List EIA: X7R X8R Murata Temperature Characteristic: X8L

L×W (mm)	1.0×0.5					1.6×0.8							2.0×1.25														
	0.55					0.9							0.95			1.45											
T max. (mm)	0.55					0.9							0.95			1.45											
Rated Voltage (Vdc)	50	25	16	100	100	50	25	16	6.3	50	25	100	50	25	16												
Cap. / TC Code	X7R	X8L	X7R	X8L	X7R	X8R	X8L	X8R	X7R	X8R	X7R	X8L	X8R	X7R	X7R	X8R	X8R	X7R	X8L	X8R	X7R	X8L	X8R	X7R	X8L	X7R	
220pF	p44					p44																					
270pF	p44					p44																					
330pF	p44					p44																					
390pF	p44					p44																					
470pF	p44					p44																					
560pF	p44					p44																					
680pF	p44					p44																					
820pF	p44					p44																					
1000pF	p44					p44	p44			p45																	
1200pF	p44					p44	p44	p44		p45																	
1500pF	p44					p44	p44	p44		p45																	
1800pF	p44					p44	p44			p45																	
2200pF	p44					p44	p44	p44		p45																	
2700pF	p44					p44	p44	p44		p45																	
3300pF	p44					p44	p44	p44		p45																	
3900pF	p44					p44	p44	p44		p45																	
4700pF	p44					p44	p44	p44		p45																	
5600pF		p44	p44			p44	p44	p44		p45																	
6800pF		p44	p44			p44	p44	p44		p45																	
8200pF		p44	p44			p44	p44	p45		p45																	
10000pF		p44	p44			p44	p44	p45	p45	p45						p45	p45	p45									
12000pF						p44	p44																				
15000pF				p44	p44	p44	p44	p45	p45	p45						p45	p45										
18000pF				p44	p44	p44	p44									p45											
22000pF				p44	p44	p44	p44	p45	p45	p45						p45	p45										
27000pF				p44	p44	p44			p45												p45						
33000pF				p44	p44	p44		p45	p45	p45											p45	p45				p45	
39000pF				p44	p44	p44			p45												p45					p45	
47000pF				p44	p44	p44		p45	p45	p45											p45	p45				p45	
56000pF				p44	p44			p45													p45						
68000pF				p44	p44			p45	p45						p45						p45						
82000pF				p44				p45																		p45	
0.10μF				p44	p44			p45													p45	p45			p45	p45	
0.12μF								p45			p45																
0.15μF								p45			p45	p45										p45			p45	p45	
0.18μF								p45			p45											p45			p45	p45	
0.22μF								p45			p45	p45										p45			p45	p45	
0.27μF																										p45	
0.33μF										p45												p45	p45		p45	p45	
0.39μF										p45															p45	p45	
0.47μF										p45												p45			p45	p45	
0.56μF																									p45	p45	
0.68μF																									p45	p45	
0.82μF																									p45	p45	
1.0μF																									p45	p45	
1.2μF																											
1.5μF																											
2.2μF																											
3.3μF																											
3.9μF																											
4.7μF																											
10μF																											p45

Continued on the following page. ↗

Capacitance Table

p00 Each number in the Part Number List refers to the page number printed at the bottom of the page.

(→ GCG Series High Dielectric Constant Type)

p00 ← Part Number List EIA: X7R X8R Murata Temperature Characteristic: X8L

L×W (mm)	3.2×1.6						3.2×2.5			
	1.35			1.9			2.3	2.8		
T max. (mm)										
Rated Voltage (Vdc)	50	25	16	25	16	25	25			
Cap. / TC Code	X8R	X8R	X7R	X8L	X8R	X7R	X8L	X8R	X7R	X7R
220pF										
270pF										
330pF										
390pF										
470pF										
560pF										
680pF										
820pF										
1000pF										
1200pF										
1500pF										
1800pF										
2200pF										
2700pF										
3300pF										
3900pF										
4700pF										
5600pF										
6800pF										
8200pF										
10000pF										
12000pF										
15000pF										
18000pF										
22000pF										
27000pF										
33000pF										
39000pF										
47000pF										
56000pF										
68000pF										
82000pF										
0.10μF										
0.12μF										
0.15μF	p46	p46								
0.18μF										
0.22μF	p46	p46								
0.27μF										
0.33μF	p46	p46								
0.39μF										
0.47μF										
0.56μF										
0.68μF				p46				p46		
0.82μF										
1.0μF		p46	p46					p46		
1.2μF		p46								
1.5μF		p46	p46							
2.2μF		p46								
3.3μF					p46	p46			p46	
3.9μF					p46					
4.7μF					p46	p46				p46
10μF										p46

Capacitance Table

p00 Each number in the Part Number List refers to the page number printed at the bottom of the page.

GCJ Series High Dielectric Constant Type

p00 ← Part Number List EIA: X7S X7R X8R Murata Temperature Characteristic: X8L

L×W (mm)	1.6×0.8												2.0×1.25														
T max. (mm)	0.9												1.0	0.7			0.95			1.0	1.45						
Rated Voltage (Vdc)	100		50			35	25			16	10	6.3	6.3	100	50	25	100	50	25	16	250	250	100	50			
Cap. / TC Code	X8R	X7R	X8L	X8R	X7R	X8L	X8L	X8R	X7R	X8L	X7R	X7R	X7S	X7R	X7R	X7R	X7R	X7R	X7R	X7R	X7R	X7R	X7R	X7R	X8L	X7R	
220pF																											
270pF																											
330pF																											
390pF																											
470pF																											
560pF																											
680pF																											
820pF																											
1000pF	p48	p48	p48		p48													p49	p49	p50							p50
1200pF	p48	p48	p48		p48													p49	p49	p50							
1500pF	p48	p48	p48		p48													p49	p49	p50							p50
1800pF	p48	p48	p48		p48													p49	p49	p50							
2200pF	p48	p48	p48		p48													p49	p49	p50							p50
2700pF	p48	p48	p48		p48													p49	p49	p50							p50
3300pF	p48	p48	p48		p48													p49	p49	p50							p50
3900pF	p48	p48	p48		p48													p49	p49	p50							p50
4700pF	p48	p48	p48	p48	p48													p49	p49	p50							p50
5600pF	p48	p48	p48		p48													p49	p49	p50							
6800pF	p48	p48	p48		p48													p49	p49	p50							p50
8200pF	p48	p48	p48		p48													p49	p49	p50							
10000pF	p48	p48	p48	p48	p48													p49	p49	p50							p50
12000pF	p48	p48	p48		p48													p49	p49	p50							
15000pF	p48	p48	p48		p48													p49	p49								p50
18000pF	p48	p48	p48		p48													p49	p50								p50
22000pF	p48	p48	p48		p48													p49	p50								p50
27000pF	p48																										p50
33000pF	p48				p48	p48	p48																				p50
39000pF	p48				p48	p48	p48																				p50
47000pF	p48				p48																					p50	p50
56000pF	p48				p48	p48	p48																			p50	p50
68000pF	p48				p48	p48	p48																			p50	p50
82000pF					p48		p48																			p50	p50
0.10μF		p48		p48	p48																					p50	p50
0.12μF			p48																								p50
0.15μF			p48	p48			p48																				p50
0.18μF			p48				p48																				p50
0.22μF			p48	p48			p48																				p50
0.27μF																											
0.33μF											p48																p50
0.39μF											p48																p50
0.47μF											p48																p50
0.56μF																											
0.68μF																											p50
0.82μF																											p50
1.0μF																											p50
1.5μF																											
2.2μF																											
3.3μF																											p49
4.7μF																											p49
6.8μF																											
10μF																											
22μF																											
47μF																											

Continued on the following page. ↗

Capacitance Table

p00 Each number in the Part Number List refers to the page number printed at the bottom of the page.

(→ GCJ Series High Dielectric Constant Type)

p00 ← Part Number List EIA: X7S X7R X8R Murata Temperature Characteristic: X8L

L×W (mm)	3.2×1.6																							
	1.45					1.5	0.95		1.25			1.35				1.8			1.9					
T max. (mm)	1.45					1.5	0.95		1.25			1.35				1.8			1.9					
Rated Voltage (Vdc)	35	25	16	10	100	100	50	1000	630	250	100	50	25	16	1000	630	250	100	50	35	25	16		
Cap. / TC Code	X8L	X8L	X7R	X8L	X7R	X7S	X7R	X7R	X7R	X7R	X7R	X7R	X7R	X7R	X7R	X7R	X7R	X7R	X7R	X7S	X8L	X8L	X7R	X8L
220pF																								
270pF																								
330pF																								
390pF																								
470pF																								
560pF																								
680pF																								
820pF																								
1000pF																								
1200pF																								
1500pF																								
1800pF																								
2200pF																								
2700pF																								
3300pF																								
3900pF																								
4700pF																								
5600pF																								
6800pF																								
8200pF																								
10000pF																								
12000pF																								
15000pF																								
18000pF																								
22000pF																								
27000pF																								
33000pF																								
39000pF																								
47000pF																								
56000pF																								
68000pF																								
82000pF																								
0.10μF																								
0.12μF	p50	p50																						
0.15μF	p50	p50																						
0.18μF	p50	p50																						
0.22μF	p50	p50																						
0.27μF		p50	p50																					
0.33μF	p50	p50																						
0.39μF		p50	p50																					
0.47μF	p50	p50																						
0.56μF			p50	p51	p51																			
0.68μF	p50	p50	p51																					
0.82μF	p50	p50	p51																					
1.0μF	p50	p50	p51	p51		p51																		
1.5μF			p50																					
2.2μF			p51																					
3.3μF																								
4.7μF																								
6.8μF																								
10μF																								
22μF																								
47μF																								

Continued on the following page. ↗

Capacitance Table

p00 Each number in the Part Number List refers to the page number printed at the bottom of the page.

(→ GCJ Series High Dielectric Constant Type)

p00 ← Part Number List EIA: X7S X7R X8R Murata Temperature Characteristic: X8L

L×W (mm)	3.2×1.6				3.2×2.5								4.5×3.2				5.7×5.0						
	1.9		2.0		1.5		2.0		2.3		2.8		1.5		2.0		2.0						
T max. (mm)	16	10	6.3	25	630	250	1000	630	250	100	50	25	16	6.3	630	250	1000	630	250	1000	630	250	
Rated Voltage (Vdc)	X7R	X7R	X7R	X7S	X7R	X7R	X7R	X7R	X7R	X7S	X7R	X7S	X8L	X7R	X7R	X7R	X7R	X7R	X7R	X7R	X7R	X7R	X7R
Cap. / TC Code	X7R	X7R	X7R	X7S	X7R	X7R	X7R	X7R	X7R	X7S	X7R	X7S	X8L	X7R	X7R	X7R	X7R	X7R	X7R	X7R	X7R	X7R	X7R
220pF																							
270pF																							
330pF																							
390pF																							
470pF																							
560pF																							
680pF																							
820pF																							
1000pF																							
1200pF																							
1500pF																							
1800pF																							
2200pF																							
2700pF																							
3300pF																							
3900pF																							
4700pF																							
5600pF																							
6800pF					p51																		
8200pF																							
10000pF					p51																		
12000pF																							
15000pF								p51	p51														
18000pF																							
22000pF								p51	p51														
27000pF																							
33000pF										p51								p52	p52				
39000pF																							
47000pF										p52								p52	p52				
56000pF																							
68000pF					p51												p52				p52		
82000pF																							
0.10μF										p52									p52		p52	p52	
0.12μF																							
0.15μF					p51												p52					p52	
0.18μF																							
0.22μF										p52									p52		p52		
0.27μF																							
0.33μF																				p52			p52
0.39μF																							
0.47μF																			p52				p52
0.56μF																							
0.68μF																							p52
0.82μF																							
1.0μF																							p52
1.5μF																							
2.2μF											p52												
3.3μF	p51																						
4.7μF	p51											p52	p52										
6.8μF		p51												p52									
10μF	p51	p51			p51								p52										
22μF		p51	p51																				p52
47μF																							p52

Capacitance Table

p00 Each number in the Part Number List refers to the page number printed at the bottom of the page.

KCM Series High Dielectric Constant Type

p00 ← Part Number List EIA: X7R

L×W (mm)	6.1×5.3																			
T max. (mm)	3.0					3.9					5.0					6.7				
Rated Voltage (Vdc)	100	63	50	35	25	100	63	50	35	25	100	50	35	25	100	63	50	35	25	
Cap. / TC Code	X7R	X7R	X7R	X7R	X7R	X7R	X7R	X7R	X7R	X7R	X7R	X7R	X7R	X7R	X7R	X7R	X7R	X7R	X7R	
4.7μF	p55	p55	p55																	
6.8μF						p55														
10μF			p55	p55		p55	p55				p55									
15μF				p55	p55										p55					
17μF								p55	p55											
22μF									p55	p55	p55	p55			p55	p55				
33μF										p55			p55	p55				p55		
47μF																		p55	p55	
68μF																			p55	

KC3 Series High Dielectric Constant Type

p00 ← Part Number List EIA: X7T

L×W (mm)	6.1×5.3											
T max. (mm)	3.0			3.9			5.0			6.7		
Rated Voltage (Vdc)	630	450	250	630	450	250	450	250	630	450	250	
Cap. / TC Code	X7T	X7T	X7T	X7T	X7T	X7T	X7T	X7T	X7T	X7T	X7T	
0.10μF	p58											
0.15μF	p58											
0.22μF		p58		p58								
0.27μF				p58								
0.33μF	p58											
0.47μF	p58	p58							p58			
0.56μF				p58					p58			
0.68μF		p58					p58					
1.0μF					p58	p58						
1.2μF										p58		
1.5μF							p58					
2.2μF											p58	

KCA Series Temperature Compensating Type

p00 ← Part Number List EIA: U2J

L×W (mm)	6.1×5.3			
T max. (mm)	3.0	3.9	5.0	6.7
Rated Voltage (Vac)	250	250	250	250
Cap. / TC Code	U2J	U2J	U2J	U2J
100pF	p61			
150pF	p61			
220pF	p61			
330pF	p61			
470pF	p61			
680pF	p61			
1000pF	p61			
1500pF	p61			
2200pF	p61			
3300pF	p61			
4700pF		p61		
6800pF			p61	
10nF				p61

NFM Series

p00 ← Part Number List

L×W (mm)	2.0×1.25			3.2×1.6	
T max. (mm)	0.95			1.5	
Rated Voltage (Vdc)	50	16	10	100	50
Cap. / TC Code	-	-	-	-	-
220pF	p63				
470pF	p63				
1000pF	p63				
2200pF	p63				
10000pF				p63	p63
15000pF					p63
22000pF	p63				p63
0.10μF			p63		p63
0.22μF			p63		
0.47μF			p63		
1.0μF		p63			

Search Capacitors

Specifications and Test Methods, Package, Chart of Characteristic Data, please refer to the search web page.
<http://www.murata.com/en-global/products/capacitor>

GRT Series Temperature Compensating

1.0x0.5mm

T max.	Rated Voltage	TC code	Cap.	Tol.	Part Number
0.55mm	100Vdc	CGG	1.0pF	±0.25pF	GRT1555A1R0GA02#
			2.0pF	±0.25pF	GRT1555A2R0CA02#
			3.0pF	±0.25pF	GRT1555A3CA02#
			4.0pF	±0.25pF	GRT1555A4CA02#
			5.0pF	±0.25pF	GRT1555A5R0CA02#

Links are provided to the product detail pages on the web, and are shown below in the product number table from the PDF version of the catalog which is available on the web.

The screenshot shows the product detail page for GRT1555G2A1R0CA02#. The page is divided into several sections, each highlighted with a red dashed box and an arrow pointing to a corresponding callout box on the right:

- Data Sheet:** A link at the top right of the page.
- Status and Features Icons:** A set of icons representing product status and features.
- Characteristics & Applications:** A section with a link to the introduction page of each series.
- Detailed Specifications Sheet:** A table listing various specifications such as Rated value, Specifications and Test Methods, Package, Caution, Notice, etc.
- Characteristics Data:** A section with links to download data like SPICE Netlist, S parameter, and Reliability Test Data.
- Chart of Characteristic Data:** A section with multiple graphs showing frequency characteristics, DC bias characteristics, AC voltage characteristics, capacitance-temperature characteristics, and calorific property by ripple current.
- Design Tools SimSurfing:** A link at the bottom of the page to access design tools.

Data Sheet

The product details page can be output in PDF.

Status and Features Icons

The status and features of products can be checked at once. When ? is clicked, a description of each icon will be displayed.

Characteristics & Applications

This links to the introduction page of each series.

Detailed Specifications Sheet

- Rated value
- Specifications and Test Methods
- Package
- Caution, Notice (Storage, Soldering and Mounting,etc.)

Characteristics Data

The following characteristics data of the main products can be acquired.

- SPICE Netlist (mod type)
- S parameter (S2P type)
- Reliability Test Data *Typical data

- Shape (Dimensions)
- Rated Values

- Specification by Packaging Code/ Minimum Order Quantity
- Weight (1 pc/ø180mm reel)

Chart of Characteristic Data

The main products published characteristic data.

- Frequency characteristics (ESR, Impedance)
- DC bias characteristics
- AC voltage characteristics
- Capacitance - temperature characteristics
- Calorific property by ripple current

Design Tools SimSurfing

The SimSurfing design tools are useful for displaying the graph, downloading CSV data and overwriting the product number graph.

GRT Series

GCM Series

GC3 Series

GCD Series

GCE Series

GCG Series

GCJ Series

KCM Series

KC3 Series

KCA Series

NMF Series

Caution/
 Notice

AEC-Q200 meeted Monolithic Ceramic Capacitor for Infotainment

GRT Series



Capacitor meet AEC-Q200 (Grade2 or Grade3).

Features

① This product has cleared test conditions meet AEC-Q200.

This series is designed for use in Car Multimedia, Car Interior, Car Comfort application and General Electronic equipment. It is not appropriate for use in applications critical to passenger safety and car driving function (e.g. ABS, AIRBAG, etc.). Please use the GCM series is in critical application.

	General Purpose GRM Series Maximum operating temperature: 125°C	AEC-Q200 meeted GRT Series Maximum operating temperature: 125°C
Items	Test Method	Test Method
Temperature Cycle	Temperature Cycle: 5 cycles	Temperature Cycle: 1,000 cycles
Humidity Loading	Test temperature: 40±2°C Test humidity: 90 to 95%RH Test time: 500 hours	Test temperature: 85±2°C Test humidity: 80 to 85%RH Test time: 1,000 hours

② Meet AEC-Q200 (Grade2 or Grade3).

105°C product: Grade2.
 85°C product: Grade3.

③ Sn plating is applied to the external electrodes; excellent solderability.

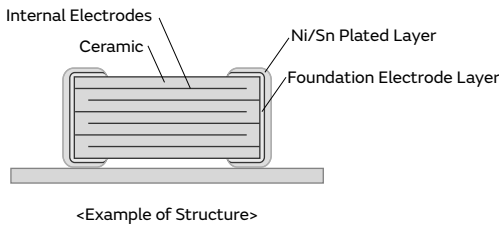

Specifications

Size	0.6×0.3mm to 3.2×2.5mm
Rated Voltage	2.5Vdc to 100Vdc
Capacitance	0.50pF to 100µF
Main Applications	Such as Information and Comfort equipment, car navigation, communication module and entertainment system

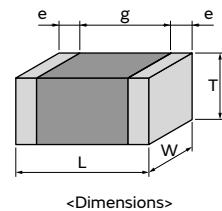

GRT Series Temperature Compensating Type Part Number List

1.0×0.5mm

T max.	Rated Voltage	TC Code	Cap.	Tol.	Part Number
0.55mm	100Vdc	COG	1.0pF	±0.25pF	GRT1555C2A1R0CA02#
			2.0pF	±0.25pF	GRT1555C2A2R0CA02#
			3.0pF	±0.25pF	GRT1555C2A3R0CA02#
			4.0pF	±0.25pF	GRT1555C2A4R0CA02#
			5.0pF	±0.25pF	GRT1555C2A5R0CA02#
			6.0pF	±0.5pF	GRT1555C2A6R0DA02#
			7.0pF	±0.5pF	GRT1555C2A7R0DA02#
			8.0pF	±0.5pF	GRT1555C2A8R0DA02#
			9.0pF	±0.5pF	GRT1555C2A9R0DA02#
			10pF	±5%	GRT1555C2A100JA02#
			12pF	±5%	GRT1555C2A120JA02#
			15pF	±5%	GRT1555C2A150JA02#
			18pF	±5%	GRT1555C2A180JA02#
			22pF	±5%	GRT1555C2A220JA02#
			27pF	±5%	GRT1555C2A270JA02#
			33pF	±5%	GRT1555C2A330JA02#
			39pF	±5%	GRT1555C2A390JA02#
			47pF	±5%	GRT1555C2A470JA02#
			56pF	±5%	GRT1555C2A560JA02#
			68pF	±5%	GRT1555C2A680JA02#
			82pF	±5%	GRT1555C2A820JA02#
	100pF	±5%	GRT1555C2A101JA02#		
	50Vdc	COG	1.0pF	±0.25pF	GRT1555C1H1R0CA02#
			2.0pF	±0.25pF	GRT1555C1H2R0CA02#
			3.0pF	±0.25pF	GRT1555C1H3R0CA02#
			4.0pF	±0.25pF	GRT1555C1H4R0CA02#
			5.0pF	±0.25pF	GRT1555C1H5R0CA02#
			6.0pF	±0.5pF	GRT1555C1H6R0DA02#
			7.0pF	±0.5pF	GRT1555C1H7R0DA02#
			8.0pF	±0.5pF	GRT1555C1H8R0DA02#
			9.0pF	±0.5pF	GRT1555C1H9R0DA02#
			10pF	±5%	GRT1555C1H100JA02#
			12pF	±5%	GRT1555C1H120JA02#
			15pF	±5%	GRT1555C1H150JA02#
			18pF	±5%	GRT1555C1H180JA02#
			22pF	±5%	GRT1555C1H220JA02#
			27pF	±5%	GRT1555C1H270JA02#
			33pF	±5%	GRT1555C1H330JA02#
			39pF	±5%	GRT1555C1H390JA02#
			47pF	±5%	GRT1555C1H470JA02#
			56pF	±5%	GRT1555C1H560JA02#
			68pF	±5%	GRT1555C1H680JA02#
82pF			±5%	GRT1555C1H820JA02#	
100pF	±5%	GRT1555C1H101JA02#			
120pF	±5%	GRT1555C1H121JA02#			
150pF	±5%	GRT1555C1H151JA02#			
180pF	±5%	GRT1555C1H181JA02#			
220pF	±5%	GRT1555C1H221JA02#			
270pF	±5%	GRT1555C1H271JA02#			
330pF	±5%	GRT1555C1H331JA02#			
390pF	±5%	GRT1555C1H391JA02#			
470pF	±5%	GRT1555C1H471JA02#			

T max.	Rated Voltage	TC Code	Cap.	Tol.	Part Number
0.55mm	50Vdc	COG	560pF	±5%	GRT1555C1H561JA02#
			680pF	±5%	GRT1555C1H681JA02#
			820pF	±5%	GRT1555C1H821JA02#
	25Vdc	COG	1000pF	±5%	GRT1555C1H102JA02#
			10pF	±5%	GRT1555C1E100JA02#
			12pF	±5%	GRT1555C1E120JA02#
			15pF	±5%	GRT1555C1E150JA02#
			18pF	±5%	GRT1555C1E180JA02#
			22pF	±5%	GRT1555C1E220JA02#
			27pF	±5%	GRT1555C1E270JA02#
			33pF	±5%	GRT1555C1E330JA02#
			39pF	±5%	GRT1555C1E390JA02#
			47pF	±5%	GRT1555C1E470JA02#
			56pF	±5%	GRT1555C1E560JA02#
			68pF	±5%	GRT1555C1E680JA02#
			82pF	±5%	GRT1555C1E820JA02#
			100pF	±5%	GRT1555C1E101JA02#
			120pF	±5%	GRT1555C1E121JA02#
			150pF	±5%	GRT1555C1E151JA02#
			180pF	±5%	GRT1555C1E181JA02#
			220pF	±5%	GRT1555C1E221JA02#
270pF	±5%	GRT1555C1E271JA02#			
330pF	±5%	GRT1555C1E331JA02#			
390pF	±5%	GRT1555C1E391JA02#			
470pF	±5%	GRT1555C1E471JA02#			
560pF	±5%	GRT1555C1E561JA02#			
680pF	±5%	GRT1555C1E681JA02#			
820pF	±5%	GRT1555C1E821JA02#			
1000pF	±5%	GRT1555C1E102JA02#			

1.6×0.8mm

T max.	Rated Voltage	TC Code	Cap.	Tol.	Part Number
0.9mm	100Vdc	COG	1.0pF	±0.25pF	GRT1885C2A1R0CA02#
			2.0pF	±0.25pF	GRT1885C2A2R0CA02#
			3.0pF	±0.25pF	GRT1885C2A3R0CA02#
			4.0pF	±0.25pF	GRT1885C2A4R0CA02#
			5.0pF	±0.25pF	GRT1885C2A5R0CA02#
			6.0pF	±0.5pF	GRT1885C2A6R0DA02#
			7.0pF	±0.5pF	GRT1885C2A7R0DA02#
			8.0pF	±0.5pF	GRT1885C2A8R0DA02#
			9.0pF	±0.5pF	GRT1885C2A9R0DA02#
			10pF	±5%	GRT1885C2A100JA02#
			12pF	±5%	GRT1885C2A120JA02#
			15pF	±5%	GRT1885C2A150JA02#
			18pF	±5%	GRT1885C2A180JA02#
			22pF	±5%	GRT1885C2A220JA02#
			27pF	±5%	GRT1885C2A270JA02#
			33pF	±5%	GRT1885C2A330JA02#
			39pF	±5%	GRT1885C2A390JA02#
			47pF	±5%	GRT1885C2A470JA02#
			56pF	±5%	GRT1885C2A560JA02#
			68pF	±5%	GRT1885C2A680JA02#

Part number # indicates the package specification code.

GRT Series

GCM Series

GC3 Series

GCD Series

GCE Series

GCG Series

GCJ Series

KCM Series

KC3 Series

KCA Series

NMF Series

⚠Caution/
 Notice

GRT Series Temperature Compensating Type Part Number List

(→ 1.6×0.8mm)

T max.	Rated Voltage	TC Code	Cap.	Tol.	Part Number		
0.9mm	100Vdc	COG	82pF	±5%	GRT1885C2A820JA02#		
			100pF	±5%	GRT1885C2A101JA02#		
			120pF	±5%	GRT1885C2A121JA02#		
			150pF	±5%	GRT1885C2A151JA02#		
			180pF	±5%	GRT1885C2A181JA02#		
			220pF	±5%	GRT1885C2A221JA02#		
			270pF	±5%	GRT1885C2A271JA02#		
			330pF	±5%	GRT1885C2A331JA02#		
			390pF	±5%	GRT1885C2A391JA02#		
			470pF	±5%	GRT1885C2A471JA02#		
			560pF	±5%	GRT1885C2A561JA02#		
			680pF	±5%	GRT1885C2A681JA02#		
			820pF	±5%	GRT1885C2A821JA02#		
			1000pF	±5%	GRT1885C2A102JA02#		
			1200pF	±5%	GRT1885C2A122JA02#		
			1500pF	±5%	GRT1885C2A152JA02#		
			50Vdc	COG	1.0pF	±0.25pF	GRT1885C1H1R0CA02#
					2.0pF	±0.25pF	GRT1885C1H2R0CA02#
	3.0pF	±0.25pF			GRT1885C1H3R0CA02#		
	4.0pF	±0.25pF			GRT1885C1H4R0CA02#		
	5.0pF	±0.25pF			GRT1885C1H5R0CA02#		
	6.0pF	±0.5pF			GRT1885C1H6R0DA02#		
	7.0pF	±0.5pF			GRT1885C1H7R0DA02#		
	8.0pF	±0.5pF			GRT1885C1H8R0DA02#		
	9.0pF	±0.5pF			GRT1885C1H9R0DA02#		
	10pF	±5%			GRT1885C1H100JA02#		
	12pF	±5%	GRT1885C1H120JA02#				
	15pF	±5%	GRT1885C1H150JA02#				
18pF	±5%	GRT1885C1H180JA02#					
22pF	±5%	GRT1885C1H220JA02#					
27pF	±5%	GRT1885C1H270JA02#					
33pF	±5%	GRT1885C1H330JA02#					
39pF	±5%	GRT1885C1H390JA02#					
47pF	±5%	GRT1885C1H470JA02#					
56pF	±5%	GRT1885C1H560JA02#					
68pF	±5%	GRT1885C1H680JA02#					
82pF	±5%	GRT1885C1H820JA02#					
100pF	±5%	GRT1885C1H101JA02#					
120pF	±5%	GRT1885C1H121JA02#					
150pF	±5%	GRT1885C1H151JA02#					
180pF	±5%	GRT1885C1H181JA02#					
220pF	±5%	GRT1885C1H221JA02#					
270pF	±5%	GRT1885C1H271JA02#					
330pF	±5%	GRT1885C1H331JA02#					
390pF	±5%	GRT1885C1H391JA02#					
470pF	±5%	GRT1885C1H471JA02#					
560pF	±5%	GRT1885C1H561JA02#					
680pF	±5%	GRT1885C1H681JA02#					
820pF	±5%	GRT1885C1H821JA02#					
1000pF	±5%	GRT1885C1H102JA02#					
1200pF	±5%	GRT1885C1H122JA02#					
1500pF	±5%	GRT1885C1H152JA02#					
1800pF	±5%	GRT1885C1H182JA02#					
2200pF	±5%	GRT1885C1H222JA02#					

T max.	Rated Voltage	TC Code	Cap.	Tol.	Part Number		
0.9mm	50Vdc	COG	2700pF	±5%	GRT1885C1H272JA02#		
			3300pF	±5%	GRT1885C1H332JA02#		
			3900pF	±5%	GRT1885C1H392JA02#		
			4700pF	±5%	GRT1885C1H472JA02#		
			5600pF	±5%	GRT1885C1H562JA02#		
			6800pF	±5%	GRT1885C1H682JA02#		
			8200pF	±5%	GRT1885C1H822JA02#		
			10000pF	±5%	GRT1885C1H103JA02#		
			25Vdc	COG	560pF	±5%	GRT1885C1E561JA02#
					680pF	±5%	GRT1885C1E681JA02#
	820pF	±5%			GRT1885C1E821JA02#		
	1000pF	±5%			GRT1885C1E102JA02#		
	1200pF	±5%			GRT1885C1E122JA02#		
	1500pF	±5%			GRT1885C1E152JA02#		
	4700pF	±5%			GRT1885C1E472JA02#		
	5600pF	±5%			GRT1885C1E562JA02#		
	6800pF	±5%			GRT1885C1E682JA02#		
	8200pF	±5%			GRT1885C1E822JA02#		
	10000pF	±5%	GRT1885C1E103JA02#				

2.0×1.25mm

T max.	Rated Voltage	TC Code	Cap.	Tol.	Part Number
1.35mm	50Vdc	COG	6800pF	±5%	GRT21B5C1H682JA02#
			8200pF	±5%	GRT21B5C1H822JA02#
			10000pF	±5%	GRT21B5C1H103JA02#
			18000pF	±5%	GRT21B5C1H183JA02#
			22000pF	±5%	GRT21B5C1H223JA02#

3.2×1.6mm

T max.	Rated Voltage	TC Code	Cap.	Tol.	Part Number		
1.8mm	50Vdc	COG	56000pF	±5%	GRT31C5C1H563JA02#		
			68000pF	±5%	GRT31C5C1H683JA02#		
			82000pF	±5%	GRT31C5C1H823JA02#		
			0.10μF	±5%	GRT31C5C1H104JA02#		
	25Vdc	COG	0.10μF	±5%	GRT31C5C1E104JA02#		
			0.12μF	±5%	GRT31C5C1E124JA02#		
			16Vdc	COG	0.12μF	±5%	GRT31C5C1C124JA02#

Part number # indicates the package specification code.

GRT Series High Dielectric Constant Type Part Number List

0.6×0.3mm

T max.	Rated Voltage	TC Code	Cap.	Tol.	Part Number		
0.33mm	35Vdc	X5R	0.10μF	±10%	GRT033R6YA104KE01#	D1	
			470pF	±10%	GRT033R71E471KE01#		
		X7R	1000pF	±10%	GRT033R71E102KE01#		
			470pF	±10%	GRT033C81E471KE01#		
			1000pF	±10%	GRT033C81E102KE01#		
		X6S	470pF	±10%	GRT033C81E471KE01#		
	1000pF		±10%	GRT033C81E102KE01#			
	0.10μF		±10%	GRT033C81E104KE01#	D1		
	X5R	100pF	±10%	GRT033R61E101KE01#			
		220pF	±10%	GRT033R61E221KE01#			
		470pF	±10%	GRT033R61E471KE01#			
		1000pF	±10%	GRT033R61E102KE01#			
		4700pF	±10%	GRT033R61E472KE01#	D1		
		10000pF	±10%	GRT033R61E103KE01#	D1		
	16Vdc	X6S	0.10μF	±10%	GRT033C81C104KE01#		
			10000pF	±10%	GRT033R61C103KE01#		
		X5R	22000pF	±10%	GRT033R61C223KE01#	D1	
			47000pF	±10%	GRT033R61C473KE01#	D1	
	10Vdc	X7R	10000pF	±10%	GRT033R71A103KE01#		
			47000pF	±10%	GRT033R71A473KE01#	D1	
		X6S	0.10μF	±10%	GRT033C81A104KE01#		
			10000pF	±10%	GRT033R61A103KE01#		
		X5R	2200pF	±10%	GRT033R61A222KE01#		
			4700pF	±10%	GRT033R61A472KE01#		
			10000pF	±10%	GRT033R61A103KE01#		
			22000pF	±10%	GRT033R61A223KE01#		
			47000pF	±10%	GRT033R61A473KE01#		
			0.10μF	±10%	GRT033R61A104KE01#		
		6.3Vdc	X7R	2200pF	±10%	GRT033R70J222KE01#	
				4700pF	±10%	GRT033R70J472KE01#	
	10000pF			±10%	GRT033R70J103KE01#		
	2200pF			±10%	GRT033C80J222KE01#		
	4700pF			±10%	GRT033C80J472KE01#		
	10000pF			±10%	GRT033C80J103KE01#		
	X6S		22000pF	±10%	GRT033C80J223KE01#		
			47000pF	±10%	GRT033C80J473KE01#		
0.10μF			±10%	GRT033C80J104KE01#	D1		
0.22μF			±10%	GRT033C80J224KE01#	D1		
X5R			10000pF	±10%	GRT033R60J103KE01#		
			22000pF	±10%	GRT033R60J223KE01#		
	47000pF		±10%	GRT033R60J473KE01#			
	0.10μF		±10%	GRT033R60J104KE01#			
	0.22μF		±10%	GRT033R60J224KE01#	D1		
	0.47μF		±10%	GRT033R60J474KE01#	D1		
4Vdc	X6S		0.22μF	±20%	GRT033C80G224ME01#	D1	
0.35mm	6.3Vdc		X5R	1.0μF	±20%	GRT033R60J105ME13#	
	4Vdc	X5R	1.0μF	±20%	GRT033R60G105ME13#		

1.0×0.5mm

T max.	Rated Voltage	TC Code	Cap.	Tol.	Part Number
0.55mm	50Vdc	X7R	220pF	±10%	GRT155R71H221KE01#

T max.	Rated Voltage	TC Code	Cap.	Tol.	Part Number				
0.55mm	50Vdc	X7R	470pF	±10%	GRT155R71H471KE01#				
			1000pF	±10%	GRT155R71H102KE01#				
			2200pF	±10%	GRT155R71H222KE01#				
			4700pF	±10%	GRT155R71H472KE01#				
			10000pF	±10%	GRT155R71H103KE01#				
			22000pF	±10%	GRT155R71H223KE01#				
			47000pF	±10%	GRT155R71H473KE01#				
			0.10μF	±10%	GRT155R71H104KE01#				
			35Vdc	X6S	0.22μF	±10%	GRT155C8YA224KE01#	D1	
					X5R	0.22μF	±10%	GRT155R6YA224KE01#	D1
						0.47μF	±10%	GRT155R6YA474KE01#	D1
			25Vdc	X7R	10000pF	±10%	GRT155R71E103KE01#		
	22000pF	±10%			GRT155R71E223KE01#				
	47000pF	±10%			GRT155R71E473KE01#				
	0.10μF	±10%			GRT155R71E104KE01#				
	X6S	0.22μF			±10%	GRT155C81E224KE01#			
		X5R			0.22μF	±10%	GRT155R61E224KE01#		
	16Vdc		X7R	0.47μF	±10%	GRT155R61E474KE01#			
		1.0μF		±10%	GRT155R61E105KE01#	D1			
		10000pF		±10%	GRT155R71C103KE01#				
		22000pF		±10%	GRT155R71C223KE01#				
	10Vdc	X7R	47000pF	±10%	GRT155R71C473KE01#				
			0.10μF	±10%	GRT155R71C104KE01#				
			0.22μF	±10%	GRT155R71C224KE01#				
			X6S	0.47μF	±10%	GRT155C81C474KE01#			
				X5R	0.22μF	±10%	GRT155R61C224KE01#		
			6.3Vdc		X7R	0.47μF	±10%	GRT155R61C474KE01#	
		1.0μF		±10%		GRT155R61C105KE01#			
		10000pF		±10%		GRT155R71A224KE01#			
		0.47μF		±10%		GRT155R71A474KE01#			
		X6S		1.0μF		±10%	GRT155C81A105KE01#		
				X5R		0.22μF	±10%	GRT155R61A224KE01#	
		4Vdc	X7R		0.47μF	±10%	GRT155R61A474KE01#		
	1.0μF			±10%	GRT155R61A105KE01#				
	2.2μF			±10%	GRT155R61A225KE01#	D1			
	X6S			22000pF	±10%	GRT155R70J223KE01#			
				1.0μF	±10%	GRT155R70J105KE01#	D1		
	0.6mm			35Vdc	X7R	0.22μF	±10%	GRT155C80J224KE01#	
		0.47μF	±10%			GRT155C80J474KE01#			
		1.0μF	±10%			GRT155C80J105KE01#	D1		
		X6S	0.22μF			±10%	GRT155R60J224KE01#		
			0.47μF			±10%	GRT155R60J474KE01#		
		X5R	0.22μF			±10%	GRT155R60J224KE01#		
	0.47μF		±10%	GRT155R60J474KE01#					
	0.7mm	25Vdc	X7R	1.0μF	±10%	GRT155R60J105KE01#			
				2.2μF	±10%	GRT155R60J225KE01#	D1		
				X6S	0.22μF	±10%	GRT155C81E105KE01#		
					0.47μF	±10%	GRT155C81C105KE01#		
16Vdc				X7S	1.0μF	±10%	GRT155C71A105KE01#		
					4.7μF	±20%	GRT155R60J475ME13#	D1	
0.55mm	50Vdc	X5R	4.7μF	±20%	GRT155R60G475ME13#				
			2.2μF	±10%	GRT155R61E225KE01#				
0.6mm	35Vdc	X5R	4.7μF	±20%	GRT155R60G475ME13#				
			2.2μF	±10%	GRT155C81C225KE01#				

Part number # indicates the package specification code.

GRT Series

GCM Series

GC3 Series

GCD Series

GCE Series

GCG Series

GCJ Series

KCM Series

KC3 Series

KCA Series

NMF Series

⚠Caution/
 Notice

GRT Series High Dielectric Constant Type Part Number List

(→ 1.0×0.5mm)

T max.	Rated Voltage	TC Code	Cap.	Tol.	Part Number
0.7mm	16Vdc	X5R	2.2μF	±10%	GRT155R61C225KE13#
	10Vdc	X7S	2.2μF	±10%	GRT155C71A225KE13#
		X6S	2.2μF	±10%	GRT155C81A225KE13#
	2.5Vdc	X6S	10μF	±20%	GRT155C80E106ME13#

T max.	Rated Voltage	TC Code	Cap.	Tol.	Part Number
1.0mm	35Vdc	X5R	4.7μF	±10%	GRT188R6YA475KE13#
	25Vdc	X6S	2.2μF	±10%	GRT188C81E225KE13#
			4.7μF	±10%	GRT188C81E475KE13#
		X5R	10μF	±20%	GRT188R61E106ME13#
	16Vdc	X6S	10μF	±20%	GRT188C81C106ME13#
	10Vdc	X6S	10μF	±20%	GRT188C81A106ME13#

1.6×0.8mm

T max.	Rated Voltage	TC Code	Cap.	Tol.	Part Number				
0.9mm	100Vdc	X7R	10000pF	±10%	GRT188R72A103KE01#				
			50Vdc	X7R	470pF	±10%	GRT188R71H471KE13#		
					1000pF	±10%	GRT188R71H102KE01#		
					2200pF	±10%	GRT188R71H222KE01#		
					4700pF	±10%	GRT188R71H472KE01#		
					10000pF	±10%	GRT188R71H103KE01#		
					22000pF	±10%	GRT188R71H223KE01#		
					47000pF	±10%	GRT188R71H473KE01#		
					0.10μF	±10%	GRT188R71H104KE13#		
	X5R	1.0μF	±10%	GRT188R61H105KE13#					
	35Vdc	X6S	1.0μF	±10%	GRT188C8YA105KE13#				
			X5R	1.0μF	±10%	GRT188R6YA105KE13#			
				2.2μF	±10%	GRT188R6YA225KE13# D1			
	25Vdc	X7R	0.22μF	±10%	GRT188R71E224KE01#				
			0.47μF	±10%	GRT188R71E474KE13#				
			1.0μF	±10%	GRT188R71E105KE13#				
		X6S	1.0μF	±10%	GRT188C81E105KE13#				
			X5R	0.47μF	±10%	GRT188R61E474KE13#			
		1.0μF		±10%	GRT188R61E105KE13#				
		2.2μF		±10%	GRT188R61E225KE13#				
		16Vdc		X7R	0.47μF	±10%	GRT188R71C474KE01#		
			1.0μF		±10%	GRT188R71C105KE13#			
	X6S		1.0μF	±10%	GRT188C81C105KE13#				
		X5R	2.2μF	±10%	GRT188C81C225KE13#				
	10Vdc		X6S	1.0μF	±10%	GRT188C81A105KE13#			
		X5R		1.0μF	±10%	GRT188R61A105KE01#			
				2.2μF	±10%	GRT188R61A225KE13#			
	6.3Vdc	X7R	2.2μF	±10%	GRT188R70J225KE13#				
			X6S	4.7μF	±10%	GRT188C80J475KE01# D1			
		X5R		1.0μF	±10%	GRT188R60J105KE01#			
				2.2μF	±10%	GRT188R60J225KE13#			
		4.7μF		±10%	GRT188R60J475KE01#				
			10μF	±20%	GRT188R60J106ME13#				
4Vdc	X6S	1.0μF	±20%	GRT188C80G105ME01#					
		4.7μF	±10%	GRT188C80G475KE01#					
		10μF	±20%	GRT188C80G106ME13# D1					
X5R	10μF	±20%	GRT188R60G106ME13#						
		0.95mm	25Vdc	X5R	4.7μF	±10%	GRT188R61E475KE13#		
					16Vdc	X6S	4.7μF	±10%	GRT188C81C475KE13#
							X5R	4.7μF	±10%
10μF	±10%	GRT188R61C106KE13#							
10Vdc	X5R	10μF	±10%	GRT188R61A106KE13# D1					
		35Vdc	X6S	2.2μF	±10%	GRT188C8YA225KE13#			

2.0×1.25mm

T max.	Rated Voltage	TC Code	Cap.	Tol.	Part Number				
1.35mm	100Vdc	X7R	47000pF	±10%	GRT21BR72A473KE01#				
			50Vdc	X7R	22000pF	±10%	GRT21BR71H223KE01#		
					47000pF	±10%	GRT21BR71H473KE01#		
					0.10μF	±10%	GRT21BR71H104KE01#		
					0.47μF	±10%	GRT21BR71H474KE01#		
					1.0μF	±10%	GRT21BR71H105KE01#		
					25Vdc	X6S	2.2μF	±10%	GRT21BC81E225KA02#
							4.7μF	±10%	GRT21BC81E475KA02#
							X5R	2.2μF	±10%
	4.7μF	±10%	GRT21BR61E475KA02#						
	16Vdc	X7R	2.2μF	±10%	GRT21BR71C225KE01#				
			X6S	2.2μF	±10%	GRT21BC81C225KA02#			
				4.7μF	±10%	GRT21BC81C475KA02#			
		X5R	10μF	±10%	GRT21BC81C106KE01# D1				
			2.2μF	±10%	GRT21BR61C225KA02#				
				4.7μF	±10%	GRT21BR61C475KA02#			
	10Vdc	X6S	10μF	±10%	GRT21BC81A106KE01#				
			X5R	10μF	±10%	GRT21BR61A106KE01#			
		6.3Vdc		X5R	10μF	±10%	GRT21BR60J106KE01#		
	1.4mm	50Vdc	X5R	2.2μF	±10%	GRT21BR61H225KE13#			
				4.7μF	±10%	GRT21BR61H475KE13#			
				35Vdc	X6S	2.2μF	±10%	GRT21BC8YA225KE13#	
		4.7μF	±10%			GRT21BC8YA475KE13#			
		25Vdc	X7R	1.0μF	±10%	GRT21BR71E105KE13#			
2.2μF				±10%	GRT21BR71E225KE13#				
				X6S	1.0μF	±10%	GRT21BC81E105KE13#		
X5R		1.0μF	±10%		GRT21BR61E105KE13#				
		10μF	±10%	GRT21BR61E106KE13#					
16Vdc		X7R	4.7μF	±10%	GRT21BR71C475KE13#				
			10Vdc	X7R	4.7μF	±10%	GRT21BR71A475KE13#		
10μF		±10%			GRT21BR71A106KE13#				
X5R	4.7μF	±10%	GRT21BR61A475KE13#						
		22μF	±20%	GRT21BR61A226ME13# D1					
		6.3Vdc	X7R	10μF	±10%	GRT21BR70J106KE13#			
X5R	4.7μF			±10%	GRT21BR60J475KE13#				
	22μF	±20%	GRT21BR60J226ME13#						
1.45mm	25Vdc	X5R	22μF	±20%	GRT21BR61E226ME13#				
			16Vdc	X5R	22μF	±20%	GRT21BR61C226ME13#		
	10Vdc	X6S	22μF	±20%	GRT21BC81A226ME13#				
	6.3Vdc	X5R	47μF	±20%	GRT21BR60J476ME13# D1				
			4Vdc	X5R	47μF	±20%	GRT21BR60G476ME13#		

Part number # indicates the package specification code.

GRT Series High Dielectric Constant Type Info-tainment AEC-Q200 Part Number List

3.2×1.6mm

T max.	Rated Voltage	TC Code	Cap.	Tol.	Part Number	
1.8mm	50Vdc	X7R	2.2μF	±10%	GRT31CR71H225KE13#	
		X6S	2.2μF	±10%	GRT31CC81H225KE01#	
		X5R	2.2μF	±10%	GRT31CR61H225KE01#	
			10μF	±10%	GRT31CR61H106KE01#	
	35Vdc	X6S	10μF	±10%	GRT31CC8YA106KE01#	
		X5R	10μF	±10%	GRT31CR6YA106KE01#	
	25Vdc	X7R	10μF	±10%	GRT31CR71E106KE13#	
			X6S	4.7μF	±10%	GRT31CC81E475KE01#
		X5R	10μF	±10%	GRT31CC81E106KE01#	
			4.7μF	±10%	GRT31CR61E475KE01#	
			10μF	±10%	GRT31CR61E106KE01#	
			22μF	±10%	GRT31CR61E226KE01#	
	16Vdc	X7R	4.7μF	±10%	GRT31CR71C475KE13#	
			X6S	4.7μF	±10%	GRT31CC81C475KE01#
			10μF	±10%	GRT31CC81C106KE01#	
		X5R	22μF	±10%	GRT31CC81C226KE01#	
			4.7μF	±10%	GRT31CR61C475KE01#	
			10μF	±10%	GRT31CR61C106KE01#	
	10Vdc	X7R	22μF	±10%	GRT31CC81C226KE01#	
			X6S	10μF	±10%	GRT31CR71A106KE13#
			10μF	±10%	GRT31CC81A106KE01#	
		X5R	22μF	±10%	GRT31CC81A226KE01#	
			10μF	±10%	GRT31CR61A106KE01#	
			22μF	±10%	GRT31CR61A226KE01#	
	6.3Vdc	X7R	47μF	±10%	GRT31CR61A476KE13#	
			X6S	22μF	±10%	GRT31CC80J226KE01#
			22μF	±10%	GRT31CC80J476KE13#	
		X5R	10μF	±10%	GRT31CR60J106KE01#	
22μF			±10%	GRT31CR60J226KE01#		
47μF			±10%	GRT31CR60J476KE13#		
4Vdc	X6S	22μF	±10%	GRT31CC80G226KE01#		
		47μF	±20%	GRT31CC80G476ME01#		

T max.	Rated Voltage	TC Code	Cap.	Tol.	Part Number
2.7mm	10Vdc	X6S	22μF	±10%	GRT32EC81A226KE13#
			47μF	±10%	GRT32EC81A476KE13#
	6.3Vdc	X7R	47μF	±10%	GRT32ER70J476KE13#
			X6S	47μF	±10%
		X5R	100μF	±20%	GRT32ER60J107ME13#

3.2×2.5mm

T max.	Rated Voltage	TC Code	Cap.	Tol.	Part Number
2.2mm	25Vdc	X6S	10μF	±10%	GRT32DC81E106KE01#
		X5R	10μF	±10%	GRT32DR61E106KE01#
	16Vdc	X6S	10μF	±10%	GRT32DC81C106KE01#
		X5R	10μF	±10%	GRT32DR61C106KE01#
			22μF	±10%	GRT32DR61C226KE01#
	10Vdc	X6S	10μF	±10%	GRT32DC81A106KE01#
		X5R	22μF	±10%	GRT32DR61A226KE01#
	6.3Vdc	X5R	22μF	±10%	GRT32DR60J226KE01#
			33μF	±20%	GRT32DR60J336ME01#
	2.7mm	50Vdc	X7R	4.7μF	±10%
X6S			4.7μF	±10%	GRT32EC81H475KE01#
X5R			4.7μF	±10%	GRT32ER61H475KE01#
25Vdc		X5R	22μF	±10%	GRT32ER61E226KE13#
16Vdc		X6S	47μF	±10%	GRT32EC81C476KE13#

GRT Series
 GCM Series
 GC3 Series
 GCD Series
 GCE Series
 GCG Series
 GCJ Series
 KCM Series
 KC3 Series
 KCA Series
 NMF Series
 ⚠Caution/Notice

GRT Series

GCM Series

GC3 Series

GCD Series

GCE Series

GCG Series

GCM Series

KCM Series

KC3 Series

KCA Series

NMF Series

△Caution/
 Notice

Monolithic Ceramic Capacitor for Automotive

GCM Series



Capacitor for automotive applications such as power train and safety equipment.

Features

① Ideal for powertrains and safety devices in automotive.

This product can be used for safety devices, such as the drive system control for engine ECU, air bags, and ABS. This product has cleared test conditions more severe than that of general products (GRM Series) even in temperature cycle and humidity load tests.

	General Purpose GRM Series Maximum operating temperature: 125°C	GCM Series for Automotive Maximum operating temperature: 150°C
Items	Test Method	Test Method
Temperature Cycle	Temperature Cycle: 5 cycles	Temperature Cycle: 100 cycles (1,000 cycles for AEC-Q200 conforming products)
Humidity Loading	Test temperature: 40±2°C Test humidity: 90 to 95%RH Test time: 500 hours	Test temperature: 85±2°C Test humidity: 80 to 85%RH Test time: 500 hours (1,000 hours for AEC-Q200 conforming products)

② Can be used at 125°C and 150°C temperatures.

We also offer a lineup for 150°C that can be used in the engine room.

③ Sn plating is applied to the external electrodes; excellent solderability.

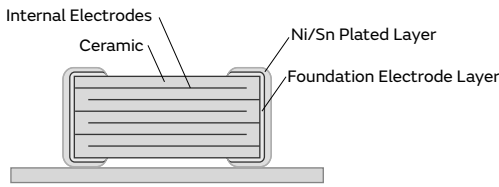

<Example of Structure>

Specifications

Size	0.6×0.3mm to 5.7×5.0mm
Rated Voltage	6.3Vdc to 1000Vdc
Capacitance	0.10pF to 47μF
Main Applications	Safety equipment, such as drive system control, air bags, and ABS of engine ECU

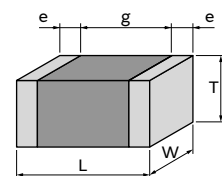

<Dimensions>

GCM Series Temperature Compensating Type Part Number List

0.6×0.3mm

T max.	Rated Voltage	TC Code	Cap.	Tol.	Part Number
0.33mm	25Vdc	COG	1.0pF	±0.25pF	GCM0335C1E1R0CD03#
			2.0pF	±0.25pF	GCM0335C1E2R0CD03#
			3.0pF	±0.25pF	GCM0335C1E3R0CD03#
			4.0pF	±0.25pF	GCM0335C1E4R0CD03#
			5.0pF	±0.25pF	GCM0335C1E5R0CD03#
			6.0pF	±0.5pF	GCM0335C1E6R0DD03#
			7.0pF	±0.5pF	GCM0335C1E7R0DD03#
			8.0pF	±0.5pF	GCM0335C1E8R0DD03#
			9.0pF	±0.5pF	GCM0335C1E9R0DD03#
			10pF	±5%	GCM0335C1E100JD03#
			12pF	±5%	GCM0335C1E120JD03#
			15pF	±5%	GCM0335C1E150JD03#
			18pF	±5%	GCM0335C1E180JD03#
			22pF	±5%	GCM0335C1E220JD03#
			27pF	±5%	GCM0335C1E270JD03#
			33pF	±5%	GCM0335C1E330JD03#
			39pF	±5%	GCM0335C1E390JD03#
			47pF	±5%	GCM0335C1E470JD03#
			56pF	±5%	GCM0335C1E560JD03#
			68pF	±5%	GCM0335C1E680JD03#
82pF	±5%	GCM0335C1E820JD03#			
100pF	±5%	GCM0335C1E101JD03#			

1.0×0.5mm

T max.	Rated Voltage	TC Code	Cap.	Tol.	Part Number
0.55mm	50Vdc	COG	1.0pF	±0.25pF	GCM1555C1H1R0CA16#
			2.0pF	±0.25pF	GCM1555C1H2R0CA16#
			3.0pF	±0.25pF	GCM1555C1H3R0CA16#
			4.0pF	±0.25pF	GCM1555C1H4R0CA16#
			5.0pF	±0.25pF	GCM1555C1H5R0CA16#
			6.0pF	±0.5pF	GCM1555C1H6R0DA16#
			7.0pF	±0.5pF	GCM1555C1H7R0DA16#
			8.0pF	±0.5pF	GCM1555C1H8R0DA16#
			9.0pF	±0.5pF	GCM1555C1H9R0DA16#
			10pF	±5%	GCM1555C1H100JA16#
			12pF	±5%	GCM1555C1H120JA16#
			15pF	±5%	GCM1555C1H150JA16#
			18pF	±5%	GCM1555C1H180JA16#
			22pF	±5%	GCM1555C1H220JA16#
			27pF	±5%	GCM1555C1H270JA16#
			33pF	±5%	GCM1555C1H330JA16#
			39pF	±5%	GCM1555C1H390JA16#
			47pF	±5%	GCM1555C1H470JA16#
			56pF	±5%	GCM1555C1H560JA16#
			68pF	±5%	GCM1555C1H680JA16#
82pF	±5%	GCM1555C1H820JA16#			
100pF	±5%	GCM1555C1H101JA16#			
120pF	±5%	GCM1555C1H121JA16#			
150pF	±5%	GCM1555C1H151JA16#			
180pF	±5%	GCM1555C1H181JA16#			

T max.	Rated Voltage	TC Code	Cap.	Tol.	Part Number
0.55mm	50Vdc	COG	220pF	±5%	GCM1555C1H221JA16#
			270pF	±5%	GCM1555C1H271JA16#
			330pF	±5%	GCM1555C1H331JA16#
			390pF	±5%	GCM1555C1H391JA16#
			470pF	±5%	GCM1555C1H471JA16#
			560pF	±5%	GCM1555C1H561JA16#
			680pF	±5%	GCM1555C1H681JA16#
			820pF	±5%	GCM1555C1H821JA16#
			1000pF	±5%	GCM1555C1H102JA16#
			X8G	1.0pF	±0.25pF
		2.0pF		±0.25pF	GCM1555G1H2R0CA16#
		3.0pF		±0.25pF	GCM1555G1H3R0CA16#
		4.0pF		±0.25pF	GCM1555G1H4R0CA16#
		5.0pF		±0.25pF	GCM1555G1H5R0CA16#
		12pF		±5%	GCM1555G1H120JA16#
		15pF		±5%	GCM1555G1H150JA16#
		18pF		±5%	GCM1555G1H180JA16#
		22pF		±5%	GCM1555G1H220JA16#
		27pF		±5%	GCM1555G1H270JA16#
		33pF	±5%	GCM1555G1H330JA16#	
39pF	±5%	GCM1555G1H390JA16#			
47pF	±5%	GCM1555G1H470JA16#			
56pF	±5%	GCM1555G1H560JA16#			
68pF	±5%	GCM1555G1H680JA16#			
82pF	±5%	GCM1555G1H820JA16#			
100pF	±5%	GCM1555G1H101JA16#			
120pF	±5%	GCM1555G1H121JA16#			
150pF	±5%	GCM1555G1H151JA16#			
180pF	±5%	GCM1555G1H181JA16#			
220pF	±5%	GCM1555G1H221JA16#			
270pF	±5%	GCM1555G1H271JA16#			
330pF	±5%	GCM1555G1H331JA16#			
390pF	±5%	GCM1555G1H391JA16#			
470pF	±5%	GCM1555G1H471JA16#			
560pF	±5%	GCM1555G1H561JA16#			
680pF	±5%	GCM1555G1H681JA16#			
820pF	±5%	GCM1555G1H821JA16#			
1000pF	±5%	GCM1555G1H102JA16#			

1.6×0.8mm

T max.	Rated Voltage	TC Code	Cap.	Tol.	Part Number
0.9mm	100Vdc	COG	1.0pF	±0.25pF	GCM1885C2A1R0CA16#
			2.0pF	±0.25pF	GCM1885C2A2R0CA16#
			3.0pF	±0.25pF	GCM1885C2A3R0CA16#
			4.0pF	±0.25pF	GCM1885C2A4R0CA16#
			5.0pF	±0.25pF	GCM1885C2A5R0CA16#
			6.0pF	±0.5pF	GCM1885C2A6R0DA16#
			7.0pF	±0.5pF	GCM1885C2A7R0DA16#
			8.0pF	±0.5pF	GCM1885C2A8R0DA16#
			9.0pF	±0.5pF	GCM1885C2A9R0DA16#
			10pF	±5%	GCM1885C2A100JA16#
			12pF	±5%	GCM1885C2A120JA16#

Part number # indicates the package specification code.

GRT Series
 GCM Series
 GC3 Series
 GCD Series
 GCE Series
 GCG Series
 GCJ Series
 KCM Series
 KC3 Series
 KCA Series
 NMF Series
 ⚠Caution/ Notice

GCM Series Temperature Compensating Type Part Number List

(→ 1.6×0.8mm)

T max.	Rated Voltage	TC Code	Cap.	Tol.	Part Number		
0.9mm	100Vdc	COG	15pF	±5%	GCM1885C2A150JA16#		
			18pF	±5%	GCM1885C2A180JA16#		
			22pF	±5%	GCM1885C2A220JA16#		
			27pF	±5%	GCM1885C2A270JA16#		
			33pF	±5%	GCM1885C2A330JA16#		
			39pF	±5%	GCM1885C2A390JA16#		
			47pF	±5%	GCM1885C2A470JA16#		
			56pF	±5%	GCM1885C2A560JA16#		
			68pF	±5%	GCM1885C2A680JA16#		
			82pF	±5%	GCM1885C2A820JA16#		
			100pF	±5%	GCM1885C2A101JA16#		
			120pF	±5%	GCM1885C2A121JA16#		
			150pF	±5%	GCM1885C2A151JA16#		
			180pF	±5%	GCM1885C2A181JA16#		
			220pF	±5%	GCM1885C2A221JA16#		
			270pF	±5%	GCM1885C2A271JA16#		
			330pF	±5%	GCM1885C2A331JA16#		
			390pF	±5%	GCM1885C2A391JA16#		
			470pF	±5%	GCM1885C2A471JA16#		
			560pF	±5%	GCM1885C2A561JA16#		
			680pF	±5%	GCM1885C2A681JA16#		
			820pF	±5%	GCM1885C2A821JA16#		
			1000pF	±5%	GCM1885C2A102JA16#		
			1200pF	±5%	GCM1885C2A122JA16#		
			1500pF	±5%	GCM1885C2A152JA16#		
			U2J	1000pF	±5%	GCM1887U2A102JA16#	
				1200pF	±5%	GCM1887U2A122JA16#	
				1500pF	±5%	GCM1887U2A152JA16#	
				1800pF	±5%	GCM1887U2A182JA16#	
				2200pF	±5%	GCM1887U2A222JA16#	
		2700pF		±5%	GCM1887U2A272JA16#		
		3300pF		±5%	GCM1887U2A332JA16#		
		3900pF		±5%	GCM1887U2A392JA16#		
		4700pF		±5%	GCM1887U2A472JA16#		
		5600pF		±5%	GCM1887U2A562JA16#		
		6800pF		±5%	GCM1887U2A682JA16#		
		8200pF		±5%	GCM1887U2A822JA16#		
		10000pF		±5%	GCM1887U2A103JA16#		
		50Vdc		COG	1.0pF	±0.25pF	GCM1885C1H1R0CA16#
					2.0pF	±0.25pF	GCM1885C1H2R0CA16#
			3.0pF		±0.25pF	GCM1885C1H3R0CA16#	
			4.0pF		±0.25pF	GCM1885C1H4R0CA16#	
			5.0pF		±0.25pF	GCM1885C1H5R0CA16#	
			6.0pF		±0.5pF	GCM1885C1H6R0DA16#	
			7.0pF		±0.5pF	GCM1885C1H7R0DA16#	
8.0pF	±0.5pF		GCM1885C1H8R0DA16#				
9.0pF	±0.5pF		GCM1885C1H9R0DA16#				
10pF	±5%		GCM1885C1H100JA16#				
12pF	±5%		GCM1885C1H120JA16#				
15pF	±5%		GCM1885C1H150JA16#				
18pF	±5%		GCM1885C1H180JA16#				
22pF	±5%		GCM1885C1H220JA16#				
27pF	±5%		GCM1885C1H270JA16#				
33pF	±5%	GCM1885C1H330JA16#					

T max.	Rated Voltage	TC Code	Cap.	Tol.	Part Number	
0.9mm	50Vdc	COG	39pF	±5%	GCM1885C1H390JA16#	
			47pF	±5%	GCM1885C1H470JA16#	
			56pF	±5%	GCM1885C1H560JA16#	
			68pF	±5%	GCM1885C1H680JA16#	
			82pF	±5%	GCM1885C1H820JA16#	
			100pF	±5%	GCM1885C1H101JA16#	
			120pF	±5%	GCM1885C1H121JA16#	
			150pF	±5%	GCM1885C1H151JA16#	
			180pF	±5%	GCM1885C1H181JA16#	
			220pF	±5%	GCM1885C1H221JA16#	
			270pF	±5%	GCM1885C1H271JA16#	
			330pF	±5%	GCM1885C1H331JA16#	
			390pF	±5%	GCM1885C1H391JA16#	
			470pF	±5%	GCM1885C1H471JA16#	
			560pF	±5%	GCM1885C1H561JA16#	
			680pF	±5%	GCM1885C1H681JA16#	
			820pF	±5%	GCM1885C1H821JA16#	
			1000pF	±5%	GCM1885C1H102JA16#	
			1200pF	±5%	GCM1885C1H122JA16#	
			1500pF	±5%	GCM1885C1H152JA16#	
			1800pF	±5%	GCM1885C1H182JA16#	
			2200pF	±5%	GCM1885C1H222JA16#	
			2700pF	±5%	GCM1885C1H272JA16#	
			3300pF	±5%	GCM1885C1H332JA16#	
			3900pF	±5%	GCM1885C1H392JA16#	
			U2J	1000pF	±5%	GCM1887U1H102JA16#
				1200pF	±5%	GCM1887U1H122JA16#
				1500pF	±5%	GCM1887U1H152JA16#
				1800pF	±5%	GCM1887U1H182JA16#
				2200pF	±5%	GCM1887U1H222JA16#
		2700pF		±5%	GCM1887U1H272JA16#	
		3300pF		±5%	GCM1887U1H332JA16#	
		3900pF		±5%	GCM1887U1H392JA16#	
		4700pF		±5%	GCM1887U1H472JA16#	
		5600pF		±5%	GCM1887U1H562JA16#	
		6800pF		±5%	GCM1887U1H682JA16#	
		8200pF		±5%	GCM1887U1H822JA16#	
		10000pF		±5%	GCM1887U1H103JA16#	

2.0×1.25mm

T max.	Rated Voltage	TC Code	Cap.	Tol.	Part Number
0.7mm	100Vdc	COG	100pF	±5%	GCM2165C2A101JA16#
			120pF	±5%	GCM2165C2A121JA16#
			150pF	±5%	GCM2165C2A151JA16#
			180pF	±5%	GCM2165C2A181JA16#
			220pF	±5%	GCM2165C2A221JA16#
			270pF	±5%	GCM2165C2A271JA16#
			330pF	±5%	GCM2165C2A331JA16#
			390pF	±5%	GCM2165C2A391JA16#
			470pF	±5%	GCM2165C2A471JA16#
			560pF	±5%	GCM2165C2A561JA16#
			680pF	±5%	GCM2165C2A681JA16#

Part number # indicates the package specification code.

GRT Series
 GCM Series
 GC3 Series
 GCD Series
 GCE Series
 GCG Series
 GCJ Series
 KCM Series
 KC3 Series
 KCA Series
 NMF Series
 ⚠Caution/ Notice

GCM Series Temperature Compensating Type Part Number List

(→ 2.0×1.25mm)

T max.	Rated Voltage	TC Code	Cap.	Tol.	Part Number			
0.7mm	100Vdc	COG	820pF	±5%	GCM2165C2A821JA16#			
			1000pF	±5%	GCM2165C2A102JA16#			
			1200pF	±5%	GCM2165C2A122JA16#			
			1500pF	±5%	GCM2165C2A152JA16#			
			1800pF	±5%	GCM2165C2A182JA16#			
			2200pF	±5%	GCM2165C2A222JA16#			
			2700pF	±5%	GCM2165C2A272JA16#			
			3300pF	±5%	GCM2165C2A332JA16#			
	50Vdc	COG	1000pF	±5%	GCM2165C1H102JA16#			
			1200pF	±5%	GCM2165C1H122JA16#			
			1500pF	±5%	GCM2165C1H152JA16#			
			1800pF	±5%	GCM2165C1H182JA16#			
			2200pF	±5%	GCM2165C1H222JA16#			
			2700pF	±5%	GCM2165C1H272JA16#			
			3300pF	±5%	GCM2165C1H332JA16#			
			3900pF	±5%	GCM2165C1H392JA16#			
			4700pF	±5%	GCM2165C1H472JA16#			
			0.95mm	100Vdc	ZLM	1000pF	±10%	GCM2199E2A102KA05#
							±20%	GCM2199E2A102MA05#
						1100pF	±10%	GCM2199E2A112KA05#
±20%	GCM2199E2A112MA05#							
1200pF	±10%	GCM2199E2A122KA05#						
	±20%	GCM2199E2A122MA05#						
1300pF	±10%	GCM2199E2A132KA05#						
	±20%	GCM2199E2A132MA05#						
1500pF	±10%	GCM2199E2A152KA05#						
	±20%	GCM2199E2A152MA05#						
80Vdc	COG	15000pF		±5%	GCM2195C1K153JA16#			
63Vdc	COG	15000pF		±5%	GCM2195C1J153JA16#			
50Vdc	COG	5600pF		±5%	GCM2195C1H562JA16#			
		6800pF		±5%	GCM2195C1H682JA16#			
		8200pF		±5%	GCM2195C1H822JA16#			
		10000pF		±5%	GCM2195C1H103JA16#			
		12000pF		±5%	GCM2195C1H123JA16#			
		15000pF		±5%	GCM2195C1H153JA16#			
1.0mm	250Vdc	U2J		100pF	±5%	GCM21A7U2E101JX01#		
				120pF	±5%	GCM21A7U2E121JX01#		
			150pF	±5%	GCM21A7U2E151JX01#			
			180pF	±5%	GCM21A7U2E181JX01#			
			220pF	±5%	GCM21A7U2E221JX01#			
			270pF	±5%	GCM21A7U2E271JX01#			
			330pF	±5%	GCM21A7U2E331JX01#			
			390pF	±5%	GCM21A7U2E391JX01#			
			470pF	±5%	GCM21A7U2E471JX01#			
			560pF	±5%	GCM21A7U2E561JX01#			
			680pF	±5%	GCM21A7U2E681JX01#			
			820pF	±5%	GCM21A7U2E821JX01#			
	1000pF	±5%	GCM21A7U2E102JX01#					
	1200pF	±5%	GCM21A7U2E122JX01#					
	1500pF	±5%	GCM21A7U2E152JX01#					
	1800pF	±5%	GCM21A7U2E182JX01#					
	2200pF	±5%	GCM21A7U2E222JX01#					
	1.4mm	80Vdc	COG	18000pF	±5%	GCM21B5C1K183JA16#		
				20000pF	±5%	GCM21B5C1K203JA16#		

T max.	Rated Voltage	TC Code	Cap.	Tol.	Part Number	
1.4mm	80Vdc	COG	22000pF	±5%	GCM21B5C1K223JA16#	
			63Vdc	COG	18000pF	±5%
	50Vdc	COG	20000pF		±5%	GCM21B5C1J203JA16#
			22000pF	±5%	GCM21B5C1J223JA16#	
	1.45mm	250Vdc	U2J	18000pF	±5%	GCM21B5C1H183JA16#
				22000pF	±5%	GCM21B5C1H223JA16#
250Vdc		U2J	2700pF	±5%	GCM21B7U2E272JX03#	
			3300pF	±5%	GCM21B7U2E332JX03#	
			3900pF	±5%	GCM21B7U2E392JX03#	
			4700pF	±5%	GCM21B7U2E472JX03#	
5600pF	±5%	GCM21B7U2E562JX03#				

3.2×1.6mm

T max.	Rated Voltage	TC Code	Cap.	Tol.	Part Number		
0.95mm	100Vdc	COG	1800pF	±5%	GCM3195C2A182JA16#		
			2200pF	±5%	GCM3195C2A222JA16#		
			2700pF	±5%	GCM3195C2A272JA16#		
			3300pF	±5%	GCM3195C2A332JA16#		
			3900pF	±5%	GCM3195C2A392JA16#		
			4700pF	±5%	GCM3195C2A472JA16#		
			5600pF	±5%	GCM3195C2A562JA16#		
			6800pF	±5%	GCM3195C2A682JA16#		
			8200pF	±5%	GCM3195C2A822JA16#		
			10000pF	±5%	GCM3195C2A103JA16#		
			80Vdc	COG	33000pF	±5%	GCM3195C1K333JA16#
			63Vdc	COG	33000pF	±5%	GCM3195C1J333JA16#
	50Vdc	COG	3900pF	±5%	GCM3195C1H392JA16#		
			4700pF	±5%	GCM3195C1H472JA16#		
			5600pF	±5%	GCM3195C1H562JA16#		
			6800pF	±5%	GCM3195C1H682JA16#		
			8200pF	±5%	GCM3195C1H822JA16#		
			10000pF	±5%	GCM3195C1H103JA16#		
			12000pF	±5%	GCM3195C1H123JA16#		
			15000pF	±5%	GCM3195C1H153JA16#		
1.0mm	1000Vdc	COG	10pF	±5%	GCM31A5C3A100JX01#		
			12pF	±5%	GCM31A5C3A120JX01#		
			15pF	±5%	GCM31A5C3A150JX01#		
			18pF	±5%	GCM31A5C3A180JX01#		
			22pF	±5%	GCM31A5C3A220JX01#		
			27pF	±5%	GCM31A5C3A270JX01#		
			33pF	±5%	GCM31A5C3A330JX01#		
			39pF	±5%	GCM31A5C3A390JX01#		
			47pF	±5%	GCM31A5C3A470JX01#		
			56pF	±5%	GCM31A5C3A560JX01#		
			68pF	±5%	GCM31A5C3A680JX01#		
			82pF	±5%	GCM31A5C3A820JX01#		
100pF	±5%	GCM31A5C3A101JX01#					

Part number # indicates the package specification code.

GCM Series Temperature Compensating Type Power-train AEC-Q200 Part Number List

(→ 3.2×1.6mm)

T max.	Rated Voltage	TC Code	Cap.	Tol.	Part Number	T max.	Rated Voltage	TC Code	Cap.	Tol.	Part Number		
1.0mm	1000Vdc	COG	120pF	±5%	GCM31A5C3A121JX01#	1.0mm	630Vdc	COG	1800pF	±5%	GCM31A5C2J182JX01#		
			150pF	±5%	GCM31A5C3A151JX01#				U2J	10pF	±5%	GCM31A7U2J100JX01#	
			180pF	±5%	GCM31A5C3A181JX01#					12pF	±5%	GCM31A7U2J120JX01#	
			220pF	±5%	GCM31A5C3A221JX01#					15pF	±5%	GCM31A7U2J150JX01#	
			270pF	±5%	GCM31A5C3A271JX01#					18pF	±5%	GCM31A7U2J180JX01#	
			330pF	±5%	GCM31A5C3A331JX01#					22pF	±5%	GCM31A7U2J220JX01#	
			390pF	±5%	GCM31A5C3A391JX01#					27pF	±5%	GCM31A7U2J270JX01#	
			470pF	±5%	GCM31A5C3A471JX01#					33pF	±5%	GCM31A7U2J330JX01#	
			U2J	10pF	±5%					GCM31A7U3A100JX01#	39pF	±5%	GCM31A7U2J390JX01#
				12pF	±5%					GCM31A7U3A120JX01#	47pF	±5%	GCM31A7U2J470JX01#
				15pF	±5%					GCM31A7U3A150JX01#	56pF	±5%	GCM31A7U2J560JX01#
				18pF	±5%					GCM31A7U3A180JX01#	68pF	±5%	GCM31A7U2J680JX01#
				22pF	±5%					GCM31A7U3A220JX01#	82pF	±5%	GCM31A7U2J820JX01#
				27pF	±5%					GCM31A7U3A270JX01#	100pF	±5%	GCM31A7U2J101JX01#
				33pF	±5%					GCM31A7U3A330JX01#	120pF	±5%	GCM31A7U2J121JX01#
		39pF		±5%	GCM31A7U3A390JX01#			150pF		±5%	GCM31A7U2J151JX01#		
		47pF		±5%	GCM31A7U3A470JX01#			180pF	±5%	GCM31A7U2J181JX01#			
		56pF		±5%	GCM31A7U3A560JX01#			220pF	±5%	GCM31A7U2J221JX01#			
		68pF		±5%	GCM31A7U3A680JX01#			270pF	±5%	GCM31A7U2J271JX01#			
		82pF		±5%	GCM31A7U3A820JX01#			330pF	±5%	GCM31A7U2J331JX01#			
		100pF		±5%	GCM31A7U3A101JX01#			390pF	±5%	GCM31A7U2J391JX01#			
		120pF		±5%	GCM31A7U3A121JX01#			470pF	±5%	GCM31A7U2J471JX01#			
		150pF		±5%	GCM31A7U3A151JX01#			560pF	±5%	GCM31A7U2J561JX01#			
		180pF	±5%	GCM31A7U3A181JX01#	680pF			±5%	GCM31A7U2J681JX01#				
		220pF	±5%	GCM31A7U3A221JX01#	820pF			±5%	GCM31A7U2J821JX01#				
		270pF	±5%	GCM31A7U3A271JX01#	1000pF			±5%	GCM31A7U2J102JX01#				
		330pF	±5%	GCM31A7U3A331JX01#	1200pF			±5%	GCM31A7U2J122JX01#				
		630Vdc	COG	10pF	±5%			GCM31A5C2J100JX01#	250Vdc	COG	10pF	±5%	GCM31A5C2E100JX01#
				12pF	±5%			GCM31A5C2J120JX01#			12pF	±5%	GCM31A5C2E120JX01#
				15pF	±5%			GCM31A5C2J150JX01#			15pF	±5%	GCM31A5C2E150JX01#
	18pF			±5%	GCM31A5C2J180JX01#		18pF	±5%			GCM31A5C2E180JX01#		
	22pF			±5%	GCM31A5C2J220JX01#		22pF	±5%			GCM31A5C2E220JX01#		
	27pF			±5%	GCM31A5C2J270JX01#		27pF	±5%			GCM31A5C2E270JX01#		
	33pF			±5%	GCM31A5C2J330JX01#		33pF	±5%			GCM31A5C2E330JX01#		
	39pF			±5%	GCM31A5C2J390JX01#		39pF	±5%			GCM31A5C2E390JX01#		
	47pF			±5%	GCM31A5C2J470JX01#		47pF	±5%			GCM31A5C2E470JX01#		
	56pF			±5%	GCM31A5C2J560JX01#		56pF	±5%			GCM31A5C2E560JX01#		
	68pF			±5%	GCM31A5C2J680JX01#		68pF	±5%	GCM31A5C2E680JX01#				
	82pF			±5%	GCM31A5C2J820JX01#		82pF	±5%	GCM31A5C2E820JX01#				
	100pF			±5%	GCM31A5C2J101JX01#		100pF	±5%	GCM31A5C2E101JX01#				
	120pF			±5%	GCM31A5C2J121JX01#		120pF	±5%	GCM31A5C2E121JX01#				
	150pF			±5%	GCM31A5C2J151JX01#		150pF	±5%	GCM31A5C2E151JX01#				
	180pF			±5%	GCM31A5C2J181JX01#		180pF	±5%	GCM31A5C2E181JX01#				
	220pF			±5%	GCM31A5C2J221JX01#		220pF	±5%	GCM31A5C2E221JX01#				
	270pF			±5%	GCM31A5C2J271JX01#		270pF	±5%	GCM31A5C2E271JX01#				
	330pF			±5%	GCM31A5C2J331JX01#		330pF	±5%	GCM31A5C2E331JX01#				
	390pF			±5%	GCM31A5C2J391JX01#		390pF	±5%	GCM31A5C2E391JX01#				
	470pF	±5%	GCM31A5C2J471JX01#	470pF	±5%		GCM31A5C2E471JX01#						
	560pF	±5%	GCM31A5C2J561JX01#	560pF	±5%		GCM31A5C2E561JX01#						
	680pF	±5%	GCM31A5C2J681JX01#	680pF	±5%		GCM31A5C2E681JX01#						
820pF	±5%	GCM31A5C2J821JX01#	820pF	±5%	GCM31A5C2E821JX01#								
1000pF	±5%	GCM31A5C2J102JX01#											
1200pF	±5%	GCM31A5C2J122JX01#											
1500pF	±5%	GCM31A5C2J152JX01#											

Part number # indicates the package specification code.

GRT Series
 GCM Series
 GC3 Series
 GCD Series
 GCE Series
 GCG Series
 GCJ Series
 KCM Series
 KC3 Series
 KCA Series
 NMF Series
 ⚠Caution/ Notice

GCM Series Temperature Compensating Type Part Number List

(→ 3.2×1.6mm)

T max.	Rated Voltage	TC Code	Cap.	Tol.	Part Number			
1.0mm	250Vdc	COG	1000pF	±5%	GCM31A5C2E102JX01#			
			1200pF	±5%	GCM31A5C2E122JX01#			
			1500pF	±5%	GCM31A5C2E152JX01#			
			1800pF	±5%	GCM31A5C2E182JX01#			
			2200pF	±5%	GCM31A5C2E222JX01#			
			2700pF	±5%	GCM31A5C2E272JX01#			
			3300pF	±5%	GCM31A5C2E332JX01#			
			3900pF	±5%	GCM31A5C2E392JX01#			
			4700pF	±5%	GCM31A5C2E472JX01#			
			5600pF	±5%	GCM31A5C2E562JX01#			
			6800pF	±5%	GCM31A5C2E682JX01#			
			U2J	2700pF	±5%	GCM31A7U2E272JX01#		
		3300pF		±5%	GCM31A7U2E332JX01#			
		3900pF		±5%	GCM31A7U2E392JX01#			
		4700pF		±5%	GCM31A7U2E472JX01#			
		5600pF		±5%	GCM31A7U2E562JX01#			
		6800pF		±5%	GCM31A7U2E682JX01#			
		1.25mm	1000Vdc	COG	560pF	±5%	GCM31B5C3A561JX01#	
680pF	±5%				GCM31B5C3A681JX01#			
U2J	390pF				±5%	GCM31B7U3A391JX01#		
	470pF				±5%	GCM31B7U3A471JX01#		
	560pF				±5%	GCM31B7U3A561JX01#		
	680pF				±5%	GCM31B7U3A681JX01#		
	630Vdc			COG	2200pF	±5%	GCM31B5C2J222JX01#	
					2700pF	±5%	GCM31B5C2J272JX01#	
U2J					2700pF	±5%	GCM31B7U2J272JX01#	
				3300pF	±5%	GCM31B7U2J332JX01#		
				250Vdc	COG	8200pF	±5%	GCM31B5C2E822JX01#
10000pF						±5%	GCM31B5C2E103JX01#	
12000pF	±5%		GCM31B5C2E123JX01#					
U2J	6800pF		±5%		GCM31B7U2E682JX01#			
	8200pF		±5%		GCM31B7U2E822JX01#			
	10000pF		±5%		GCM31B7U2E103JX01#			
50Vdc	COG		47000pF	±5%	GCM31M5C1H473JA16#			
			56000pF	±5%	GCM31M5C1H563JA16#			
	1.8mm	1000Vdc	COG	820pF	±5%	GCM31C5C3A821JX03#		
				1000pF	±5%	GCM31C5C3A102JX03#		
				U2J	820pF	±5%	GCM31C7U3A821JX03#	
			1000pF		±5%	GCM31C7U3A102JX03#		
630Vdc			COG		3300pF	±5%	GCM31C5C2J332JX03#	
				U2J	3900pF	±5%	GCM31C7U2J392JX03#	
		4700pF			±5%	GCM31C7U2J472JX03#		
		250Vdc	COG		15000pF	±5%	GCM31C5C2E153JX03#	
				50Vdc	COG	68000pF	±5%	GCM31C5C1H683JA16#
						75000pF	±5%	GCM31C5C1H753JA16#
82000pF			±5%			GCM31C5C1H823JA16#		
91000pF			±5%			GCM31C5C1H913JA16#		
0.10μF	±5%		GCM31C5C1H104JA16#					

3.2×2.5mm

T max.	Rated Voltage	TC Code	Cap.	Tol.	Part Number
1.0mm	630Vdc	U2J	1200pF	±5%	GCM32A7U2J122JX01#
			1500pF	±5%	GCM32A7U2J152JX01#

T max.	Rated Voltage	TC Code	Cap.	Tol.	Part Number
1.0mm	630Vdc	U2J	1800pF	±5%	GCM32A7U2J182JX01#
			2200pF	±5%	GCM32A7U2J222JX01#
1.25mm	1000Vdc	U2J	1200pF	±5%	GCM32B7U3A122JX01#
	630Vdc	U2J	5600pF	±5%	GCM32B7U2J562JX01#
1.5mm	1000Vdc	U2J	1500pF	±5%	GCM32Q7U3A152JX01#
	630Vdc	U2J	6800pF	±5%	GCM32Q7U2J682JX01#
2.0mm	1000Vdc	U2J	1800pF	±5%	GCM32D7U3A182JX01#
			2200pF	±5%	GCM32D7U3A222JX01#
	630Vdc	U2J	8200pF	±5%	GCM32D7U2J822JX01#
			10000pF	±5%	GCM32D7U2J103JX01#

4.5×3.2mm

T max.	Rated Voltage	TC Code	Cap.	Tol.	Part Number
1.5mm	1000Vdc	U2J	2700pF	±5%	GCM43Q7U3A272JX01#
			3300pF	±5%	GCM43Q7U3A332JX01#
	630Vdc	U2J	12000pF	±5%	GCM43Q7U2J123JX01#
			2.0mm	1000Vdc	U2J
4700pF	±5%	GCM43D7U3A472JX01#			
630Vdc	U2J	15000pF		±5%	GCM43D7U2J153JX01#
		18000pF		±5%	GCM43D7U2J183JX01#
22000pF	±5%	GCM43D7U2J223JX01#			

5.7×5.0mm

T max.	Rated Voltage	TC Code	Cap.	Tol.	Part Number
1.5mm	1000Vdc	U2J	5600pF	±5%	GCM55Q7U3A562JX01#
			6800pF	±5%	GCM55Q7U3A682JX01#
	630Vdc	U2J	27000pF	±5%	GCM55Q7U2J273JX01#
			2.0mm	1000Vdc	U2J
10000pF	±5%	GCM55D7U3A103JX01#			
630Vdc	U2J	33000pF		±5%	GCM55D7U2J333JX01#
		39000pF		±5%	GCM55D7U2J393JX01#
47000pF	±5%	GCM55D7U2J473JX01#			

Part number # indicates the package specification code.

GRT Series
GCM Series
GC3 Series
GCD Series
GCE Series
GCG Series
GCJ Series
KCM Series
KC3 Series
KCA Series
NMF Series
Caution/Notice

GCM Series High Dielectric Constant Type Part Number List

0.6×0.3mm

T max.	Rated Voltage	TC Code	Cap.	Tol.	Part Number
0.33mm	25Vdc	X7R	100pF	±10%	GCM033R71E101KA03#
			150pF	±10%	GCM033R71E151KA03#
			220pF	±10%	GCM033R71E221KA03#
			330pF	±10%	GCM033R71E331KA03#
			470pF	±10%	GCM033R71E471KA03#
			680pF	±10%	GCM033R71E681KA03#
			1000pF	±10%	GCM033R71E102KA03#
			1500pF	±10%	GCM033R71E152KA03#
			2200pF	±10%	GCM033R71C222KA55#
			3300pF	±10%	GCM033R71C332KA55#
	16Vdc	X7R	4700pF	±10%	GCM033R71A472KA03#
			6800pF	±10%	GCM033R71A682KA03#
			10000pF	±10%	GCM033R71A103KA03#
	10Vdc	X7R	4700pF	±10%	GCM033R71A472KA03#
			6800pF	±10%	GCM033R71A682KA03#
			10000pF	±10%	GCM033R71A103KA03#

1.0×0.5mm

T max.	Rated Voltage	TC Code	Cap.	Tol.	Part Number
0.55mm	100Vdc	X7R	220pF	±10%	GCM155R72A221KA37#
			330pF	±10%	GCM155R72A331KA37#
			470pF	±10%	GCM155R72A471KA37#
			680pF	±10%	GCM155R72A681KA37#
			1000pF	±10%	GCM155R72A102KA37#
			1500pF	±10%	GCM155R72A152KA37#
			2200pF	±10%	GCM155R72A222KA37#
			3300pF	±10%	GCM155R72A332KA37#
			4700pF	±10%	GCM155R72A472KA37#
				50Vdc	X7R
330pF	±10%	GCM155R71H331KA37#			
470pF	±10%	GCM155R71H471KA37#			
680pF	±10%	GCM155R71H681KA37#			
1000pF	±10%	GCM155R71H102KA37#			
1500pF	±10%	GCM155R71H152KA37#			
2200pF	±10%	GCM155R71H222KA37#			
3300pF	±10%	GCM155R71H332KA37#			
4700pF	±10%	GCM155R71H472KA37#			
6800pF	±10%	GCM155R71H682KA55#			
	25Vdc	X7R	10000pF	±10%	GCM155R71E103KA37#
			15000pF	±10%	GCM155R71E153KA55#
			22000pF	±10%	GCM155R71E223KA55#
			33000pF	±10%	GCM155R71E333KA55#
			47000pF	±10%	GCM155R71E473KA55#
			68000pF	±10%	GCM155R71E683KA55#
			0.10μF	±10%	GCM155R71H104KE02#
			0.3300pF	±10%	GCM155R71C333KA55#
			47000pF	±10%	GCM155R71E473KA55#
			68000pF	±10%	GCM155R71C683KA55#
	16Vdc	X7R	33000pF	±10%	GCM155R71C333KA37#
			47000pF	±10%	GCM155R71C473KA37#
			68000pF	±10%	GCM155R71C683KA55#

T max.	Rated Voltage	TC Code	Cap.	Tol.	Part Number
0.55mm	16Vdc	X7R	0.10μF	±10%	GCM155R71C104KA55#
			0.15μF	±10%	GCM155R71C154KE02#
			0.22μF	±10%	GCM155R71C224KE02#
0.6mm	10Vdc	X7S	0.47μF	±10%	GCM155C71A474KE36#
0.7mm	10Vdc	X7S	0.68μF	±10%	GCM155C71A684KE38#
			1.0μF	±10%	GCM155C71A105KE38#

1.6×0.8mm

T max.	Rated Voltage	TC Code	Cap.	Tol.	Part Number
0.9mm	100Vdc	X7R	1000pF	±10%	GCM188R72A102KA37#
			1500pF	±10%	GCM188R72A152KA37#
			2200pF	±10%	GCM188R72A222KA37#
			3300pF	±10%	GCM188R72A332KA37#
			4700pF	±10%	GCM188R72A472KA37#
			6800pF	±10%	GCM188R72A682KA37#
			10000pF	±10%	GCM188R72A103KA37#
			15000pF	±10%	GCM188R72A153KA37#
			22000pF	±10%	GCM188R72A223KA37#
				50Vdc	X7R
1500pF	±10%	GCM188R71H152KA37#			
2200pF	±10%	GCM188R71H222KA37#			
3300pF	±10%	GCM188R71H332KA37#			
4700pF	±10%	GCM188R71H472KA37#			
6800pF	±10%	GCM188R71H682KA37#			
10000pF	±10%	GCM188R71H103KA37#			
15000pF	±10%	GCM188R71H153KA37#			
22000pF	±10%	GCM188R71H223KA37#			
33000pF	±10%	GCM188R71H333KA55#			
	25Vdc	X7R	33000pF	±10%	GCM188R71E333KA37#
			47000pF	±10%	GCM188R71E473KA37#
			68000pF	±10%	GCM188R71E683KA57#
			0.10μF	±10%	GCM188R71E104KA57#
			0.15μF	±10%	GCM188R71E154KA64#
			0.22μF	±10%	GCM188R71E224KA64#
			0.3300pF	±10%	GCM188R71E333KA37#
			47000pF	±10%	GCM188R71E473KA37#
			68000pF	±10%	GCM188R71E683KA57#
			0.10μF	±10%	GCM188R71E104KA57#
	16Vdc	X7R	0.10μF	±10%	GCM188R71C104KA37#
			0.33μF	±10%	GCM188R71C334KA37#
			0.47μF	±10%	GCM188R71C474KA55#
			1.0μF	±10%	GCM188R71C105KA64#
			2.2μF	±10%	GCM188R70J225KE22#
			0.10μF	±10%	GCM188R71C104KA37#
			0.33μF	±10%	GCM188R71C334KA37#
			0.47μF	±10%	GCM188R71C474KA55#
			1.0μF	±10%	GCM188R71C105KA64#
			2.2μF	±10%	GCM188R70J225KE22#

2.0×1.25mm

T max.	Rated Voltage	TC Code	Cap.	Tol.	Part Number
0.7mm	100Vdc	X7R	6800pF	±10%	GCM216R72A682KA37#

Part number # indicates the package specification code.

GCM Series High Dielectric Constant Type Power-train AEC-Q200 Part Number List

(→ 2.0×1.25mm)

T max.	Rated Voltage	TC Code	Cap.	Tol.	Part Number	
0.7mm	100Vdc	X7R	10000pF	±10%	GCM216R72A103KA37#	
			15000pF	±10%	GCM216R72A153KA37#	
			22000pF	±10%	GCM216R72A223KA37#	
0.95mm	100Vdc	X7R	33000pF	±10%	GCM219R72A333KA37#	
			50Vdc	X7R	33000pF	±10%
				0.33μF	±10%	GCM219R71H334KA55#
	25Vdc	X7R	0.47μF	±10%	GCM219R71E474KA55#	
	16Vdc	X7R	0.68μF	±10%	GCM219R71C684KA37#	
1.4mm	100Vdc	X7R	47000pF	±10%	GCM21BR72A473KA37#	
			68000pF	±10%	GCM21BR72A683KA37#	
			0.10μF	±10%	GCM21BR72A104KA37#	
	50Vdc	X7R	47000pF	±10%	GCM21BR71H473KA37#	
			68000pF	±10%	GCM21BR71H683KA37#	
			0.10μF	±10%	GCM21BR71H104KA37#	
			0.15μF	±10%	GCM21BR71H154KA37#	
			0.22μF	±10%	GCM21BR71H224KA37#	
			0.47μF	±10%	GCM21BR71H474KA55#	
	35Vdc	X7R	1.0μF	±10%	GCM21BR71H105KA03#	
0.68μF			±10%	GCM21BR7YA684KA55#		
1.0μF			±10%	GCM21BR7YA105KA55#		
		1.5μF	±10%	GCM21BR7YA155KA54#		
25Vdc	X7R	2.2μF	±10%	GCM21BC7YA225KE02#		
		0.15μF	±10%	GCM21BR71E154KA37#		
		0.22μF	±10%	GCM21BR71E224KA37#		
		0.33μF	±10%	GCM21BR71E334KA37#		
		0.68μF	±10%	GCM21BR71E684KA55#		
		1.0μF	±10%	GCM21BR71E105KA56#		
		1.5μF	±10%	GCM21BR71E155KA54#		
		2.2μF	±10%	GCM21BR71E225KA73#		
16Vdc	X7R	2.2μF	±10%	GCM21BR71C225KA64#		
		4.7μF	±10%	GCM21BR71C475KA73#		
10Vdc	X7R	2.2μF	±10%	GCM21BR71A225KA37#		
		10μF	±10%	GCM21BR71A106KE22#		
	X7S	4.7μF	±10%	GCM21BC71A475KA73#		
6.3Vdc	X7R	10μF	±10%	GCM21BR70J106KE22#		
1.45mm	100Vdc	X7S	1.0μF	±10%	GCM21BC72A105KE36#	
	35Vdc	X7S	4.7μF	±10%	GCM21BC7YA475KE36#	
	25Vdc	X7S	4.7μF	±10%	GCM21BC71E475KE36#	

3.2×1.6mm

T max.	Rated Voltage	TC Code	Cap.	Tol.	Part Number
0.95mm	100Vdc	X7R	0.10μF	±10%	GCM319R72A104KA37#
1.25mm	100Vdc	X7R	0.15μF	±10%	GCM31MR72A154KA37#
			0.22μF	±10%	GCM31MR72A224KA37#
	50Vdc	X7R	0.33μF	±10%	GCM31MR71H334KA37#
			0.47μF	±10%	GCM31MR71H474KA37#
			0.68μF	±10%	GCM31MR71H684KA55#
		1.0μF	±10%	GCM31MR71H105KA55#	
1.3mm	25Vdc	X7R	2.2μF	±10%	GCM31MR71E225KA57#
1.8mm	100Vdc	X7R	1.0μF	±10%	GCM31CR72A105KA03#
		X7S	2.2μF	±10%	GCM31CC72A225KE02#

T max.	Rated Voltage	TC Code	Cap.	Tol.	Part Number
1.8mm	50Vdc	X7R	2.2μF	±10%	GCM31CR71H225KA55#
		X7S	4.7μF	±10%	GCM31CC71H475KA03#
	25Vdc	X7R	4.7μF	±10%	GCM31CR71E475KA55#
	16Vdc	X7R	4.7μF	±10%	GCM31CR71C475KA37#
			10μF	±10%	GCM31CR71C106KA64#
	10Vdc	X7R	10μF	±10%	GCM31CR71A106KA64#
		22μF	±10%	GCM31CR71A226KE02#	
1.9mm	6.3Vdc	X7R	22μF	±20%	GCM31CR70J226ME23#
1.9mm	25Vdc	X7S	10μF	±10%	GCM31CC71E106KA03#

3.2×2.5mm

T max.	Rated Voltage	TC Code	Cap.	Tol.	Part Number
2.2mm	100Vdc	X7S	4.7μF	±10%	GCM32DC72A475KE02#
	25Vdc	X7R	4.7μF	±10%	GCM32DR71E475KA55#
	16Vdc	X7R	10μF	±10%	GCM32DR71C106KA37#
2.7mm	50Vdc	X7R	1.0μF	±10%	GCM32ER71H105KA37#
			4.7μF	±10%	GCM32ER71H475KA55#
		X7S	10μF	±10%	GCM32EC71H106KA03#
	35Vdc	X7S	10μF	±10%	GCM32EC7YA106KA03#
	25Vdc	X7R	10μF	±10%	GCM32ER71E106KA57#
	16Vdc	X7R	22μF	±20%	GCM32ER71C226ME19#
	10Vdc	X7R	22μF	±20%	GCM32ER71A226ME12#
	6.3Vdc	X7R	47μF	±20%	GCM32ER70J476ME19#

Part number # indicates the package specification code.

GRT Series

GCM Series

GC3 Series

GCD Series

GCE Series

GCG Series

G CJ Series

KCM Series

KC3 Series

KCA Series

NMF Series

Caution/ Notice

High Effective Capacitance & High Ripple Resistance Monolithic Ceramic Capacitors

GC3 Series



This is a high ripple resistance product for automotive excellent in DC bias characteristics

Features

- 1 When a DC bias is applied, a capacitance higher than conventional products (X7R characteristics) can be acquired.

When DC600V is applied, about twice the capacitance can be secured.

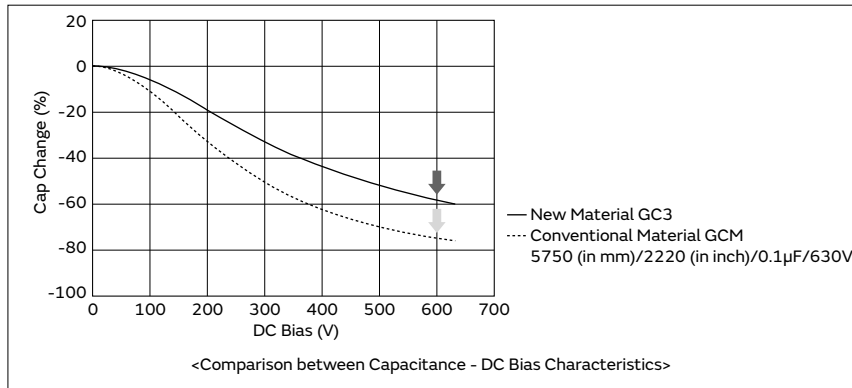

- 2 Improved ripple resistance performance compared to conventional products (X7R characteristics).

In the case of a product with a capacitance of 0.1μF, when the exothermic temperature reaches 20°C at frequency f=300kHz, the amount of resistance of a product with conventional material is 1.8Arms; however, the new material is 2.3Arms.

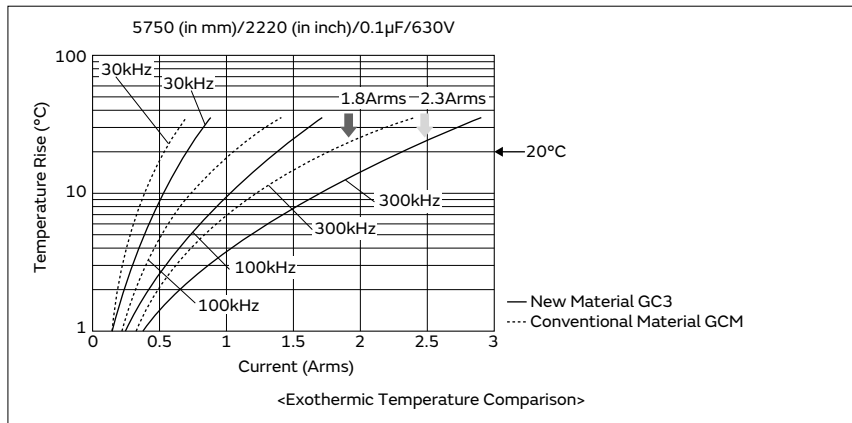

- 3 This product has a noise reduction effect.

Since dielectric materials that enable a reduction of noise are used, this product is more effective for reducing noise compared to the GCM series for automotive.

Specifications

Size	2.0×1.25mm to 5.7×5.0mm
Rated Voltage	250Vdc to 630Vdc
Capacitance	10000pF to 1.0μF
Main Applications	For PFC (Power Factor Correction) Circuits of Power Supplies, EMI Suppression and Smoothing Circuits of automotive

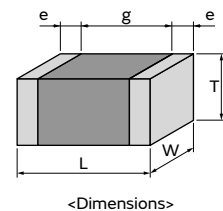

GC3 Series High Dielectric Constant Type Part Number List

2.0×1.25mm

T max.	Rated Voltage	TC Code	Cap.	Tol.	Part Number
1.0mm	250Vdc	X7T	10000pF	±10%	GC321AD72E103KX01#
			15000pF	±10%	GC321AD72E153KX01#
1.45mm	250Vdc	X7T	22000pF	±10%	GC321BD72E223KX03#

T max.	Rated Voltage	TC Code	Cap.	Tol.	Part Number
2.7mm	250Vdc	X7T	1.0μF	±10%	GC355XD72E105KX05#

3.2×1.6mm

T max.	Rated Voltage	TC Code	Cap.	Tol.	Part Number
1.0mm	450Vdc	X7T	10000pF	±10%	GC331AD72W103KX01#
			15000pF	±10%	GC331AD72W153KX01#
	250Vdc	X7T	33000pF	±10%	GC331AD72E333KX01#
1.25mm	630Vdc	X7T	10000pF	±10%	GC331BD72J103KX01#
	450Vdc	X7T	22000pF	±10%	GC331BD72W223KX01#
			33000pF	±10%	GC331BD72W333KX01#
	250Vdc	X7T	47000pF	±10%	GC331BD72E473KX01#
1.8mm	630Vdc	X7T	15000pF	±10%	GC331CD72J153KX03#
	450Vdc	X7T	47000pF	±10%	GC331CD72W473KX03#
	250Vdc	X7T	68000pF	±10%	GC331CD72E683KX03#

3.2×2.5mm

T max.	Rated Voltage	TC Code	Cap.	Tol.	Part Number
1.5mm	630Vdc	X7T	22000pF	±10%	GC332QD72J223KX01#
	250Vdc	X7T	0.10μF	±10%	GC332QD72E104KX01#
2.0mm	630Vdc	X7T	33000pF	±10%	GC332DD72J333KX01#
			47000pF	±10%	GC332DD72J473KX01#
	450Vdc	X7T	68000pF	±10%	GC332DD72W683KX01#
			0.10μF	±10%	GC332DD72W104KX01#
	250Vdc	X7T	0.15μF	±10%	GC332DD72E154KX01#

4.5×3.2mm

T max.	Rated Voltage	TC Code	Cap.	Tol.	Part Number
1.5mm	250Vdc	X7T	0.22μF	±10%	GC343QD72E224KX01#
2.0mm	630Vdc	X7T	68000pF	±10%	GC343DD72J683KX01#
	450Vdc	X7T	0.15μF	±10%	GC343DD72W154KX01#
	250Vdc	X7T	0.33μF	±10%	GC343DD72E334KX01#

5.7×5.0mm

T max.	Rated Voltage	TC Code	Cap.	Tol.	Part Number
2.0mm	630Vdc	X7T	0.10μF	±10%	GC355DD72J104KX01#
			0.15μF	±10%	GC355DD72J154KX01#
	450Vdc	X7T	0.22μF	±10%	GC355DD72W224KX01#
			0.33μF	±10%	GC355DD72W334KX01#
			0.47μF	±10%	GC355DD72W474KX01#
	250Vdc	X7T	0.47μF	±10%	GC355DD72E474KX01#
0.68μF			±10%	GC355DD72E684KX01#	
2.7mm	630Vdc	X7T	0.22μF	±10%	GC355XD72J224KX05#

Part number # indicates the package specification code.

Monolithic Ceramic Capacitor Specially Designed to Reduce Shorts

GCD Series      

Prevents momentary dielectric breakdown by a 2-element array structure!

Features

① Prevents momentary dielectric breakdown by a 2-element array structure!

This product consists of 2 elements arranged in 1 capacitor. It is structured so that even when 1 element is shorted, the other capacitor element will not short.

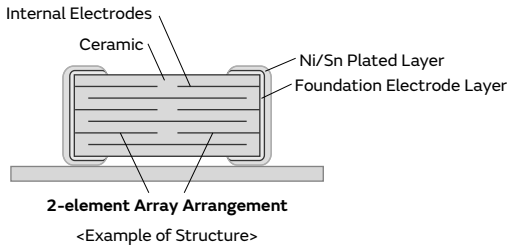

② This AEC-Q200 conforming product is ideal for the battery lines of automotive.

Space can be reduced in battery lines where 2 capacitors are arranged in an array.

Specifications

Size	1.6×0.8mm to 2.0×1.25mm
Rated Voltage	16Vdc to 100Vdc
Capacitance	1000pF to 0.50μF
Main Applications	Battery Lines and Powertrains for automotive

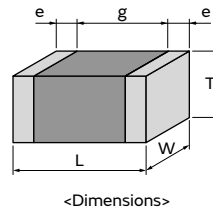

GCD Series High Dielectric Constant Type Part Number List

1.6×0.8mm

T max.	Rated Voltage	TC Code	Cap.	Tol.	Part Number		
0.9mm	100Vdc	X7R	1000pF	±10%	GCD188R72A102KA01#		
			1200pF	±10%	GCD188R72A122KA01#		
			1500pF	±10%	GCD188R72A152KA01#		
			1800pF	±10%	GCD188R72A182KA01#		
			2200pF	±10%	GCD188R72A222KA01#		
			2700pF	±10%	GCD188R72A272KA01#		
			3300pF	±10%	GCD188R72A332KA01#		
			3900pF	±10%	GCD188R72A392KA01#		
			4700pF	±10%	GCD188R72A472KA01#		
			5600pF	±10%	GCD188R72A562KA01#		
			6800pF	±10%	GCD188R72A682KA01#		
			8200pF	±10%	GCD188R72A822KA01#		
			10000pF	±10%	GCD188R72A103KA01#		
			12000pF	±10%	GCD188R72A123KA01#		
			15000pF	±10%	GCD188R72A153KA01#		
			18000pF	±10%	GCD188R72A183KA01#		
			22000pF	±10%	GCD188R72A223KA01#		
			50Vdc	X7R	1000pF	±10%	GCD188R71H102KA01#
			1200pF		±10%	GCD188R71H122KA01#	
			1500pF		±10%	GCD188R71H152KA01#	
			1800pF		±10%	GCD188R71H182KA01#	
			2200pF		±10%	GCD188R71H222KA01#	
			2700pF		±10%	GCD188R71H272KA01#	
			3300pF		±10%	GCD188R71H332KA01#	
	3900pF	±10%	GCD188R71H392KA01#				
	4700pF	±10%	GCD188R71H472KA01#				
	5600pF	±10%	GCD188R71H562KA01#				
	6800pF	±10%	GCD188R71H682KA01#				
	8200pF	±10%	GCD188R71H822KA01#				
	10000pF	±10%	GCD188R71H103KA01#				
	12000pF	±10%	GCD188R71H123KA01#				
	15000pF	±10%	GCD188R71H153KA01#				
	18000pF	±10%	GCD188R71H183KA01#				
	22000pF	±10%	GCD188R71H223KA01#				
	25Vdc	X7R	27000pF	±10%	GCD188R71E273KA01#		
	33000pF		±10%	GCD188R71E333KA01#			
39000pF	±10%		GCD188R71E393KA01#				
47000pF	±10%		GCD188R71E473KA01#				

T max.	Rated Voltage	TC Code	Cap.	Tol.	Part Number		
0.7mm	100Vdc	X7R	5600pF	±10%	GCD216R72A562KA01#		
			1000pF	±10%	GCD216R71H102KA01#		
			1200pF	±10%	GCD216R71H122KA01#		
			1500pF	±10%	GCD216R71H152KA01#		
			1800pF	±10%	GCD216R71H182KA01#		
			2200pF	±10%	GCD216R71H222KA01#		
			2700pF	±10%	GCD216R71H272KA01#		
			3300pF	±10%	GCD216R71H332KA01#		
			3900pF	±10%	GCD216R71H392KA01#		
	4700pF	±10%	GCD216R71H472KA01#				
	5600pF	±10%	GCD216R71H562KA01#				
	0.95mm	100Vdc	X7R	6800pF	±10%	GCD219R72A682KA01#	
	1.4mm	100Vdc	X7R	8200pF	±10%	GCD21BR72A822KA01#	
				10000pF	±10%	GCD21BR72A103KA01#	
				12000pF	±10%	GCD21BR72A123KA01#	
				15000pF	±10%	GCD21BR72A153KA01#	
				18000pF	±10%	GCD21BR72A183KA01#	
				22000pF	±10%	GCD21BR72A223KA01#	
27000pF				±10%	GCD21BR72A273KA01#		
33000pF				±10%	GCD21BR72A333KA01#		
39000pF				±10%	GCD21BR72A393KA01#		
47000pF				±10%	GCD21BR72A473KA01#		
56000pF				±10%	GCD21BR72A563KA01#		
68000pF				±10%	GCD21BR72A683KA01#		
82000pF				±10%	GCD21BR72A823KA01#		
0.10μF				±10%	GCD21BR72A104KA01#		
50Vdc				X7R	15000pF	±10%	GCD21BR71H153KA01#
18000pF					±10%	GCD21BR71H183KA01#	
22000pF					±10%	GCD21BR71H223KA01#	
27000pF					±10%	GCD21BR71H273KA01#	
33000pF		±10%	GCD21BR71H333KA01#				
39000pF		±10%	GCD21BR71H393KA01#				
47000pF		±10%	GCD21BR71H473KA01#				
56000pF		±10%	GCD21BR71H563KA01#				
68000pF		±10%	GCD21BR71H683KA01#				
82000pF		±10%	GCD21BR71H823KA01#				
0.10μF		±10%	GCD21BR71H104KA01#				

2.0×1.25mm

T max.	Rated Voltage	TC Code	Cap.	Tol.	Part Number
0.7mm	100Vdc	X7R	1000pF	±10%	GCD216R72A102KA01#
			1200pF	±10%	GCD216R72A122KA01#
			1500pF	±10%	GCD216R72A152KA01#
			1800pF	±10%	GCD216R72A182KA01#
			2200pF	±10%	GCD216R72A222KA01#
			2700pF	±10%	GCD216R72A272KA01#
			3300pF	±10%	GCD216R72A332KA01#
			3900pF	±10%	GCD216R72A392KA01#
			4700pF	±10%	GCD216R72A472KA01#

Part number # indicates the package specification code.

Fail Safe Design Monolithic Ceramic Capacitors

GCE Series



Further improved safety performance with a combination of a 2-element array structure & resin external electrodes!

Features

① Avoid instantaneous dielectric breakdown with the 2-element array structure

This product is configured with 2 elements arranged in one capacitor. Even if one element short circuits, the other element in the capacitor does not short.

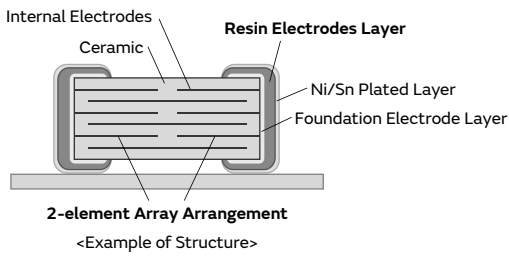

② Provides additional safety performance in combination with resin electrodes

Adopting resin electrodes as the external electrodes will suppress the occurrence of cracking in the capacitor by mechanical stress.

● For Automotive (GCM Series)

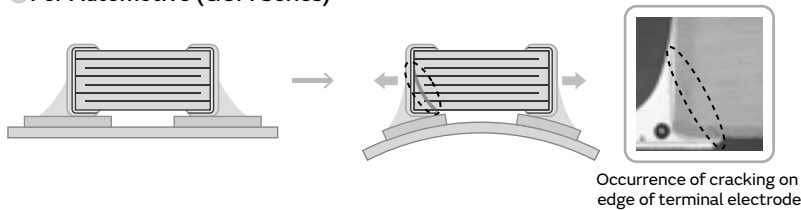

● Fail Safe Design (GCE Series)

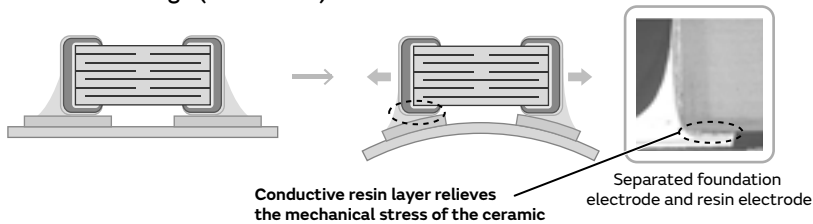

③ Ideal for battery lines of on-board applications

Space can be reduced for battery lines, when 2 capacitors are configured in an array.

Specifications

Size	1.6×0.8mm to 2.0×1.25mm
Rated Voltage	25Vdc to 100Vdc
Capacitance	220pF to 0.10μF
Main Applications	For automotive, Battery lines, power trains

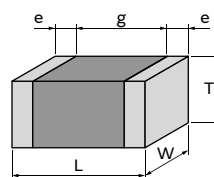

<Dimensions>

GCE Series High Dielectric Constant Type Power-train AEC-Q200 Fail safe Deflecting crack Part Number List

1.6×0.8mm

T max.	Rated Voltage	TC Code	Cap.	Tol.	Part Number
0.9mm	100Vdc	X7R	1000pF	±10%	GCE188R72A102KA01#
			1200pF	±10%	GCE188R72A122KA01#
			1500pF	±10%	GCE188R72A152KA01#
			1800pF	±10%	GCE188R72A182KA01#
			2200pF	±10%	GCE188R72A222KA01#
			2700pF	±10%	GCE188R72A272KA01#
			3300pF	±10%	GCE188R72A332KA01#
			3900pF	±10%	GCE188R72A392KA01#
			4700pF	±10%	GCE188R72A472KA01#
			5600pF	±10%	GCE188R72A562KA01#
			6800pF	±10%	GCE188R72A682KA01#
			8200pF	±10%	GCE188R72A822KA01#
			10000pF	±10%	GCE188R72A103KA01#
			12000pF	±10%	GCE188R72A123KA01#
	15000pF	±10%	GCE188R72A153KA01#		
	18000pF	±10%	GCE188R72A183KA01#		
	22000pF	±10%	GCE188R72A223KA01#		
	50Vdc	X7R	1000pF	±10%	GCE188R71H102KA01#
			1200pF	±10%	GCE188R71H122KA01#
			1500pF	±10%	GCE188R71H152KA01#
			1800pF	±10%	GCE188R71H182KA01#
			2200pF	±10%	GCE188R71H222KA01#
			2700pF	±10%	GCE188R71H272KA01#
			3300pF	±10%	GCE188R71H332KA01#
			3900pF	±10%	GCE188R71H392KA01#
			4700pF	±10%	GCE188R71H472KA01#
			5600pF	±10%	GCE188R71H562KA01#
			6800pF	±10%	GCE188R71H682KA01#
8200pF			±10%	GCE188R71H822KA01#	
10000pF			±10%	GCE188R71H103KA01#	
12000pF			±10%	GCE188R71H123KA01#	
15000pF	±10%	GCE188R71H153KA01#			
18000pF	±10%	GCE188R71H183KA01#			
22000pF	±10%	GCE188R71H223KA01#			
25Vdc	X7R	27000pF	±10%	GCE188R71E273KA01#	
		33000pF	±10%	GCE188R71E333KA01#	
		39000pF	±10%	GCE188R71E393KA01#	
		47000pF	±10%	GCE188R71E473KA01#	

2.0×1.25mm

T max.	Rated Voltage	TC Code	Cap.	Tol.	Part Number
0.7mm	100Vdc	X7R	1000pF	±10%	GCE216R72A102KA01#
			1200pF	±10%	GCE216R72A122KA01#
			1500pF	±10%	GCE216R72A152KA01#
			1800pF	±10%	GCE216R72A182KA01#
			2200pF	±10%	GCE216R72A222KA01#
			2700pF	±10%	GCE216R72A272KA01#
			3300pF	±10%	GCE216R72A332KA01#
			3900pF	±10%	GCE216R72A392KA01#
			4700pF	±10%	GCE216R72A472KA01#

T max.	Rated Voltage	TC Code	Cap.	Tol.	Part Number
0.7mm	100Vdc	X7R	5600pF	±10%	GCE216R72A562KA01#
			1000pF	±10%	GCE216R71H102KA01#
			1200pF	±10%	GCE216R71H122KA01#
			1500pF	±10%	GCE216R71H152KA01#
			1800pF	±10%	GCE216R71H182KA01#
			2200pF	±10%	GCE216R71H222KA01#
			2700pF	±10%	GCE216R71H272KA01#
	50Vdc	X7R	3300pF	±10%	GCE216R71H332KA01#
			3900pF	±10%	GCE216R71H392KA01#
			4700pF	±10%	GCE216R71H472KA01#
			5600pF	±10%	GCE216R71H562KA01#
			220pF	±10%	GCE219R72A221KA01#
			270pF	±10%	GCE219R72A271KA01#
			330pF	±10%	GCE219R72A331KA01#
0.95mm	100Vdc	X7R	390pF	±10%	GCE219R72A391KA01#
			470pF	±10%	GCE219R72A471KA01#
			560pF	±10%	GCE219R72A561KA01#
			680pF	±10%	GCE219R72A681KA01#
			820pF	±10%	GCE219R72A821KA01#
			6800pF	±10%	GCE219R72A682KA01#
			8200pF	±10%	GCE219R72A822KA01#
	50Vdc	X7R	8200pF	±10%	GCE219R72A822KA01#
			10000pF	±10%	GCE219R72A103KA01#
			12000pF	±10%	GCE219R72A123KA01#
			15000pF	±10%	GCE219R72A153KA01#
			18000pF	±10%	GCE219R72A183KA01#
			22000pF	±10%	GCE219R72A223KA01#
			27000pF	±10%	GCE219R72A273KA01#
1.45mm	100Vdc	X7R	8200pF	±10%	GCE21BR72A822KA01#
			10000pF	±10%	GCE21BR72A103KA01#
			12000pF	±10%	GCE21BR72A123KA01#
			15000pF	±10%	GCE21BR72A153KA01#
			18000pF	±10%	GCE21BR72A183KA01#
			22000pF	±10%	GCE21BR72A223KA01#
			27000pF	±10%	GCE21BR72A273KA01#
			33000pF	±10%	GCE21BR72A333KA01#
			39000pF	±10%	GCE21BR72A393KA01#
			47000pF	±10%	GCE21BR72A473KA01#
			56000pF	±10%	GCE21BR72A563KA01#
			68000pF	±10%	GCE21BR72A683KA01#
			82000pF	±10%	GCE21BR72A823KA01#
			0.10μF	±10%	GCE21BR72A104KA01#
	50Vdc	X7R	15000pF	±10%	GCE21BR71H153KA01#
			18000pF	±10%	GCE21BR71H183KA01#
			22000pF	±10%	GCE21BR71H223KA01#
			27000pF	±10%	GCE21BR71H273KA01#
			33000pF	±10%	GCE21BR71H333KA01#
			39000pF	±10%	GCE21BR71H393KA01#
			47000pF	±10%	GCE21BR71H473KA01#
			56000pF	±10%	GCE21BR71H563KA01#
			68000pF	±10%	GCE21BR71H683KA01#
			82000pF	±10%	GCE21BR71H823KA01#
			0.10μF	±10%	GCE21BR71H104KA01#

GRT Series
 GCM Series
 GC3 Series
 GCD Series
 GCE Series
 GCG Series
 GCJ Series
 KCM Series
 KC3 Series
 KCA Series
 NMF Series
 ⚠Caution/ Notice

GRT Series

GCM Series

GC3 Series

GCD Series

GCE Series

GCG Series

GCJ Series

KCM Series

KC3 Series

KCA Series

NMF Series

Caution/
 Notice

Monolithic Ceramic Capacitor Limited to Conductive Glue Mounting

GCG Series



Improved mechanical and thermal strength by adopting AgPd external electrodes, which can be mounted with a conductive glue!

Features

① Limited to Conductive Glue Mounting

This capacitor can be mounted with a conductive adhesive* in powertrains and safety devices of automotive.

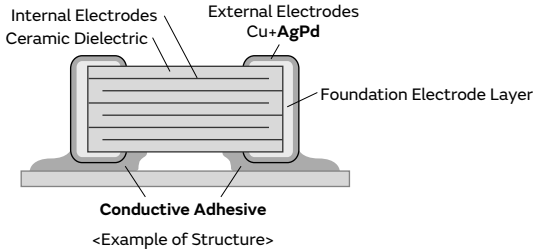

② Adopted AgPd external electrodes

Adopted AgPd, which is excellent in bonding strength with a conductive adhesive.

③ Compatible up to 150°C

This capacitor lineup with X8L and X8R characteristics can be used in high temperature environments, such as in ABS and transmission control.

* This product is for use exclusively with conductive glue mounting. It cannot be used with any mounting methods other than conductive glue mounting.
 Using solder to mount the product can result in insufficient wetting, insufficient bonding strength, and/or leaching of the Ag/Pd External Electrodes (terminations), which can cause quality problems such as the chip coming loose.

Specifications

Size	1.0×0.5mm to 3.2×2.5mm
Rated Voltage	6.3Vdc to 100Vdc
Capacitance	1.0pF to 47μF
Main Applications	For automotive, power trains, sensors

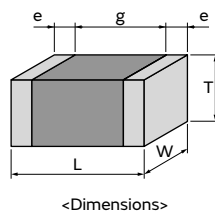

GCG Series Temperature Compensating Type Power-train AEC Q200 Deflecting crack Soldering crack Limited to conductive paste mounting Part Number List

1.0×0.5mm

T max.	Rated Voltage	TC Code	Cap.	Tol.	Part Number
0.55mm	50Vdc	X8G	120pF	±5%	GCG1555G1H121JA01#
			150pF	±5%	GCG1555G1H151JA01#
			180pF	±5%	GCG1555G1H181JA01#
			220pF	±5%	GCG1555G1H221JA01#
			270pF	±5%	GCG1555G1H271JA01#
			330pF	±5%	GCG1555G1H331JA01#
			390pF	±5%	GCG1555G1H391JA01#
			470pF	±5%	GCG1555G1H471JA01#

1.6×0.8mm

T max.	Rated Voltage	TC Code	Cap.	Tol.	Part Number
0.9mm	50Vdc	X8G	10pF	±5%	GCG1885G1H100JA01#
			12pF	±5%	GCG1885G1H120JA01#
			15pF	±5%	GCG1885G1H150JA01#
			18pF	±5%	GCG1885G1H180JA01#
			22pF	±5%	GCG1885G1H220JA01#
			27pF	±5%	GCG1885G1H270JA01#
			33pF	±5%	GCG1885G1H330JA01#
			39pF	±5%	GCG1885G1H390JA01#
			47pF	±5%	GCG1885G1H470JA01#
			56pF	±5%	GCG1885G1H560JA01#
			68pF	±5%	GCG1885G1H680JA01#
			82pF	±5%	GCG1885G1H820JA01#
			100pF	±5%	GCG1885G1H101JA01#
			120pF	±5%	GCG1885G1H121JA01#
			150pF	±5%	GCG1885G1H151JA01#
			180pF	±5%	GCG1885G1H181JA01#
			220pF	±5%	GCG1885G1H221JA01#
			270pF	±5%	GCG1885G1H271JA01#
			330pF	±5%	GCG1885G1H331JA01#
			390pF	±5%	GCG1885G1H391JA01#
			470pF	±5%	GCG1885G1H471JA01#
			560pF	±5%	GCG1885G1H561JA01#
			680pF	±5%	GCG1885G1H681JA01#
			820pF	±5%	GCG1885G1H821JA01#
			1000pF	±5%	GCG1885G1H102JA01#
			1200pF	±5%	GCG1885G1H122JA01#
			1500pF	±5%	GCG1885G1H152JA01#
			1800pF	±5%	GCG1885G1H182JA01#
			2200pF	±5%	GCG1885G1H222JA01#

2.0×1.25mm

T max.	Rated Voltage	TC Code	Cap.	Tol.	Part Number
0.7mm	50Vdc	X8G	100pF	±5%	GCG2165G1H101JA01#
			120pF	±5%	GCG2165G1H121JA01#
			150pF	±5%	GCG2165G1H151JA01#
			180pF	±5%	GCG2165G1H181JA01#
			220pF	±5%	GCG2165G1H221JA01#

T max.	Rated Voltage	TC Code	Cap.	Tol.	Part Number
0.7mm	50Vdc	X8G	270pF	±5%	GCG2165G1H271JA01#
			330pF	±5%	GCG2165G1H331JA01#
			390pF	±5%	GCG2165G1H391JA01#
			470pF	±5%	GCG2165G1H471JA01#
			560pF	±5%	GCG2165G1H561JA01#
			680pF	±5%	GCG2165G1H681JA01#
			820pF	±5%	GCG2165G1H821JA01#
			1000pF	±5%	GCG2165G1H102JA01#
			1200pF	±5%	GCG2165G1H122JA01#
			1500pF	±5%	GCG2165G1H152JA01#
			1800pF	±5%	GCG2165G1H182JA01#
			2200pF	±5%	GCG2165G1H222JA01#
			2700pF	±5%	GCG2165G1H272JA01#
			3300pF	±5%	GCG2165G1H332JA01#
			3900pF	±5%	GCG2165G1H392JA01#
4700pF	±5%	GCG2165G1H472JA01#			
0.95mm	50Vdc	X8G	5600pF	±5%	GCG2195G1H562JA01#
			6800pF	±5%	GCG2195G1H682JA01#
			8200pF	±5%	GCG2195G1H822JA01#
			10000pF	±5%	GCG2195G1H103JA01#

GRT Series
 GCM Series
 GC3 Series
 GCD Series
 GCE Series
 GCG Series
 GCJ Series
 KCM Series
 KC3 Series
 KCA Series
 NMF Series
 ⚠Caution/ Notice

GCG Series High Dielectric Constant Type Power-train AEC-Q200 Defecting crack Soldering crack Limited to conductive glue mounting Part Number List

1.0×0.5mm

T max.	Rated Voltage	TC Code	Cap.	Tol.	Part Number		
0.55mm	50Vdc	X7R	220pF	±10%	GCG155R71H221KA01#		
			270pF	±10%	GCG155R71H271KA01#		
			330pF	±10%	GCG155R71H331KA01#		
			390pF	±10%	GCG155R71H391KA01#		
			470pF	±10%	GCG155R71H471KA01#		
			560pF	±10%	GCG155R71H561KA01#		
			680pF	±10%	GCG155R71H681KA01#		
			820pF	±10%	GCG155R71H821KA01#		
			1000pF	±10%	GCG155R71H102KA01#		
			1200pF	±10%	GCG155R71H122KA01#		
			1500pF	±10%	GCG155R71H152KA01#		
			1800pF	±10%	GCG155R71H182KA01#		
			2200pF	±10%	GCG155R71H222KA01#		
			2700pF	±10%	GCG155R71H272KA01#		
			3300pF	±10%	GCG155R71H332KA01#		
			3900pF	±10%	GCG155R71H392KA01#		
			4700pF	±10%	GCG155R71H472KA01#		
			25Vdc	X8L	5600pF	±10%	GCG155L81E562KA01#
			6800pF		±10%	GCG155L81E682KA01#	
			8200pF		±10%	GCG155L81E822KA01#	
	10000pF	±10%	GCG155L81E103KA01#				
	X7R	5600pF	±10%		GCG155R71E562KA01#		
		6800pF	±10%		GCG155R71E682KA01#		
		8200pF	±10%		GCG155R71E822KA01#		
		10000pF	±10%		GCG155R71E103KA01#		
	16Vdc	X8L	15000pF		±10%	GCG155L81C153KA01#	
			18000pF		±10%	GCG155L81C183KA01#	
			22000pF	±10%	GCG155L81C223KA01#		
			27000pF	±10%	GCG155L81C273KA01#		
			33000pF	±10%	GCG155L81C333KA01#		
			39000pF	±10%	GCG155L81C393KA01#		
			47000pF	±10%	GCG155L81C473KA01#		
			X7R	15000pF	±10%	GCG155R71C153KA01#	
				18000pF	±10%	GCG155R71C183KA01#	
				22000pF	±10%	GCG155R71C223KA01#	
		27000pF		±10%	GCG155R71C273KA01#		
		33000pF		±10%	GCG155R71C333KA01#		
		39000pF		±10%	GCG155R71C393KA01#		
		47000pF		±10%	GCG155R71C473KA01#		
		56000pF		±10%	GCG155R71C563KA01#		
		68000pF		±10%	GCG155R71C683KA01#		
		82000pF		±10%	GCG155R71C823KA01#		
		0.10μF	±10%	GCG155R71C104KA01#			

1.6×0.8mm

T max.	Rated Voltage	TC Code	Cap.	Tol.	Part Number
0.9mm	100Vdc	X8R	1000pF	±10%	GCG188R92A102KA01#
			1200pF	±10%	GCG188R92A122KA01#
			1500pF	±10%	GCG188R92A152KA01#
			1800pF	±10%	GCG188R92A182KA01#

T max.	Rated Voltage	TC Code	Cap.	Tol.	Part Number
0.9mm	100Vdc	X8R	2200pF	±10%	GCG188R92A222KA01#
			2700pF	±10%	GCG188R92A272KA01#
			3300pF	±10%	GCG188R92A332KA01#
			3900pF	±10%	GCG188R92A392KA01#
			4700pF	±10%	GCG188R92A472KA01#
			5600pF	±10%	GCG188R92A562KA01#
			6800pF	±10%	GCG188R92A682KA01#
			8200pF	±10%	GCG188R92A822KA01#
			10000pF	±10%	GCG188R92A103KA01#
			12000pF	±10%	GCG188R92A123KA01#
			15000pF	±10%	GCG188R92A153KA01#
			18000pF	±10%	GCG188R92A183KA01#
			22000pF	±10%	GCG188R92A223KA01#
			27000pF	±10%	GCG188R92A273KA01#
			33000pF	±10%	GCG188R92A333KA01#
			39000pF	±10%	GCG188R92A393KA01#
			47000pF	±10%	GCG188R92A473KA01#
			56000pF	±10%	GCG188R92A563KA01#
			68000pF	±10%	GCG188R92A683KA01#
			0.10μF	±10%	GCG188R92A104KA03#
	50Vdc	X8L	220pF	±10%	GCG188L81H221KA01#
			270pF	±10%	GCG188L81H271KA01#
			330pF	±10%	GCG188L81H331KA01#
			390pF	±10%	GCG188L81H391KA01#
			470pF	±10%	GCG188L81H471KA01#
			560pF	±10%	GCG188L81H561KA01#
			680pF	±10%	GCG188L81H681KA01#
			820pF	±10%	GCG188L81H821KA01#
			1000pF	±10%	GCG188L81H102KA01#
			1200pF	±10%	GCG188L81H122KA01#
			1500pF	±10%	GCG188L81H152KA01#
			1800pF	±10%	GCG188L81H182KA01#
			2200pF	±10%	GCG188L81H222KA01#
			2700pF	±10%	GCG188L81H272KA01#
			3300pF	±10%	GCG188L81H332KA01#
			3900pF	±10%	GCG188L81H392KA01#
			4700pF	±10%	GCG188L81H472KA01#
			5600pF	±10%	GCG188L81H562KA01#
			6800pF	±10%	GCG188L81H682KA01#
			8200pF	±10%	GCG188L81H822KA01#
10000pF	±10%	GCG188L81H103KA01#			
12000pF	±10%	GCG188L81H123KA01#			
15000pF	±10%	GCG188L81H153KA01#			
18000pF	±10%	GCG188L81H183KA01#			
22000pF	±10%	GCG188L81H223KA01#			
X8R		1200pF	±10%	GCG188R91H122KA03#	
		1500pF	±10%	GCG188R91H152KA03#	
		2200pF	±10%	GCG188R91H222KA03#	
		2700pF	±10%	GCG188R91H272KA03#	
		3300pF	±10%	GCG188R91H332KA03#	
		3900pF	±10%	GCG188R91H392KA03#	
		4700pF	±10%	GCG188R91H472KA03#	
		5600pF	±10%	GCG188R91H562KA03#	
		6800pF	±10%	GCG188R91H682KA03#	

Part number # indicates the package specification code.

GCG Series High Dielectric Constant Type Part Number List

(→ 1.6×0.8mm)

T max.	Rated Voltage	TC Code	Cap.	Tol.	Part Number
0.9mm	50Vdc	X8R	8200pF	±10%	GCG188R91H822KA03#
			10000pF	±10%	GCG188R91H103KA03#
			15000pF	±10%	GCG188R91H153KA03#
			22000pF	±10%	GCG188R91H223KA03#
			33000pF	±10%	GCG188R91H333KA03#
			47000pF	±10%	GCG188R91H473KA03#
			0.10μF	±10%	GCG188R91H104KA01#
			0.12μF	±10%	GCG188R91H124KA01#
			0.15μF	±10%	GCG188R91H154KA01#
			0.18μF	±10%	GCG188R91H184KA01#
		0.22μF	±10%	GCG188R91H224KA01#	
		15000pF	±10%	GCG188R71H153KA01#	
		22000pF	±10%	GCG188R71H223KA01#	
		27000pF	±10%	GCG188R71H273KA12#	
		33000pF	±10%	GCG188R71H333KA12#	
		39000pF	±10%	GCG188R71H393KA12#	
	47000pF	±10%	GCG188R71H473KA12#		
	56000pF	±10%	GCG188R71H563KA12#		
	1200pF	±10%	GCG188R91E122KA01#		
	1500pF	±10%	GCG188R91E152KA01#		
	1800pF	±10%	GCG188R91E182KA01#		
	2200pF	±10%	GCG188R91E222KA01#		
	2700pF	±10%	GCG188R91E272KA01#		
	3300pF	±10%	GCG188R91E332KA01#		
	3900pF	±10%	GCG188R91E392KA01#		
	5600pF	±10%	GCG188R91E562KA01#		
	6800pF	±10%	GCG188R91E682KA01#		
	8200pF	±10%	GCG188R91E822KA01#		
	10000pF	±10%	GCG188R91E103KA01#		
	15000pF	±10%	GCG188R91E153KA01#		
	22000pF	±10%	GCG188R91E223KA01#		
	33000pF	±10%	GCG188R91E333KA01#		
68000pF	±10%	GCG188R91E683KA03#			
0.33μF	±10%	GCG188R91E334KA01#			
0.39μF	±10%	GCG188R91E394KA01#			
X8L	0.47μF	±10%	GCG188R91E474KA01#		
	0.12μF	±10%	GCG188R71E124KA12#		
	0.15μF	±10%	GCG188R71E154KA12#		
	0.18μF	±10%	GCG188R71E184KA12#		
X8R	0.22μF	±10%	GCG188R71E224KA12#		
	0.15μF	±10%	GCG188L81C154KA01#		
	0.22μF	±10%	GCG188L81C224KA01#		
	0.10μF	±10%	GCG188R91C104KA01#		
X7R	1.0μF	±10%	GCG188R71C105KA01#		
	2.2μF	±10%	GCG188R70J225KE01#		

2.0×1.25mm

T max.	Rated Voltage	TC Code	Cap.	Tol.	Part Number	
0.95mm	50Vdc	X8R	10000pF	±10%	GCG219R91H103KA03#	
			15000pF	±10%	GCG219R91H153KA03#	
			18000pF	±10%	GCG219R91H183KA03#	
			22000pF	±10%	GCG219R91H223KA03#	
		15000pF	±10%	GCG219R91E153KA01#		
		22000pF	±10%	GCG219R91E223KA01#		
	1.45mm	100Vdc	X7R	10000pF	±10%	GCG21BR72A103KA01#
				33000pF	±10%	GCG21BL81H273KA01#
				39000pF	±10%	GCG21BL81H333KA01#
			0.10μF	±10%	GCG21BL81H104KA03#	
			0.15μF	±10%	GCG21BR91H333KA03#	
			0.18μF	±10%	GCG21BR91H473KA03#	
0.22μF			±10%	GCG21BR91H563KA03#		
0.33μF			±10%	GCG21BR91H683KA03#		
0.15μF			±10%	GCG21BR71H154KA01#		
0.18μF		±10%	GCG21BR71H184KA01#			
0.33μF		±10%	GCG21BR71H334KA01#			
0.47μF		±10%	GCG21BR71H474KA01#			
0.10μF		±10%	GCG21BL81E104KA01#			
0.33μF		±10%	GCG21BL81E334KA01#			
0.47μF		±10%	GCG21BR91E333KA01#			
16Vdc		X8L	X8R	39000pF	±10%	GCG21BR91E393KA01#
				47000pF	±10%	GCG21BR91E473KA01#
				82000pF	±10%	GCG21BR91E823KA01#
	0.15μF		±10%	GCG21BR91E154KA03#		
	0.18μF		±10%	GCG21BR91E184KA03#		
	0.22μF		±10%	GCG21BR91E224KA03#		
	0.68μF		±10%	GCG21BR91E684KE01#		
	1.0μF		±10%	GCG21BR91E105KE01#		
	X7R		0.27μF	±10%	GCG21BR71E274KA01#	
		0.33μF	±10%	GCG21BR71E334KA01#		
		0.39μF	±10%	GCG21BR71E394KA01#		
		0.47μF	±10%	GCG21BR71E474KA01#		
		0.56μF	±10%	GCG21BR71E564KA01#		
		0.68μF	±10%	GCG21BR71E684KA01#		
		0.82μF	±10%	GCG21BR71E824KA01#		
		1.0μF	±10%	GCG21BR71E105KA12#		
		X8L	0.33μF	±10%	GCG21BL81C334KA01#	
	0.39μF		±10%	GCG21BL81C394KA01#		
0.47μF	±10%		GCG21BL81C474KA01#			
0.56μF	±10%		GCG21BL81C564KA01#			
0.68μF	±10%		GCG21BL81C684KA01#			
0.82μF	±10%		GCG21BL81C824KA01#			
4.7μF	±10%		GCG21BR71C475KA12#			

GRT Series
 GCM Series
 GC3 Series
 GCD Series
 GCE Series
 GCG Series
 GCJ Series
 KCM Series
 KC3 Series
 KCA Series
 NMF Series
 ⚠Caution/ Notice

Part number # indicates the package specification code.

GRT Series

GCM Series

GC3 Series

GCD Series

GCE Series

GCG Series

G CJ Series

KCM Series

KC3 Series

KCA Series

NMF Series

△Caution/
 Notice

GCG Series High Dielectric Constant Type Part Number List

3.2×1.6mm

T max.	Rated Voltage	TC Code	Cap.	Tol.	Part Number
1.35mm	50Vdc	X8R	0.15μF	±10%	GCG31MR91H154KA03#
			0.22μF	±10%	GCG31MR91H224KA03#
			0.33μF	±10%	GCG31MR91H334KA03#
	25Vdc	X8R	0.15μF	±10%	GCG31MR91E154KA01#
			0.22μF	±10%	GCG31MR91E224KA01#
			0.33μF	±10%	GCG31MR91E334KA01#
		X7R	1.0μF	±10%	GCG31MR71E105KA01#
			1.2μF	±10%	GCG31MR71E125KA01#
			1.5μF	±10%	GCG31MR71E155KA01#
			2.2μF	±10%	GCG31MR71E225KA12#
	16Vdc	X8L	1.0μF	±10%	GCG31ML81C105KA01#
			1.5μF	±10%	GCG31ML81C155KA01#
1.9mm	25Vdc	X8R	0.68μF	±10%	GCG31CR91E684KA03#
			X7R	3.3μF	±10%
		X7R	3.9μF	±10%	GCG31CR71E395KA01#
			4.7μF	±10%	GCG31CR71E475KA01#
	16Vdc	X8L	3.3μF	±10%	GCG31CL81C335KA01#
			4.7μF	±10%	GCG31CL81C475KA01#
		X8R	0.68μF	±10%	GCG31CR91C684KA01#
			1.0μF	±10%	GCG31CR91C105KA01#

3.2×2.5mm

T max.	Rated Voltage	TC Code	Cap.	Tol.	Part Number
2.3mm	25Vdc	X7R	3.3μF	±10%	GCG32DR71E335KA01#
2.8mm	25Vdc	X7R	4.7μF	±10%	GCG32ER71E475KA01#
			10μF	±10%	GCG32ER71E106KA12#

Resin External Electrode Monolithic Ceramic Capacitors

GCJ Series



The resin external electrodes prevent the occurrence of cracking caused by deflection stress after board mounting!

Features

① The resin external electrodes suppress cracks by board deflection.

Cracking of the ceramic element is suppressed by the resin of the external electrodes, which releases the stress.

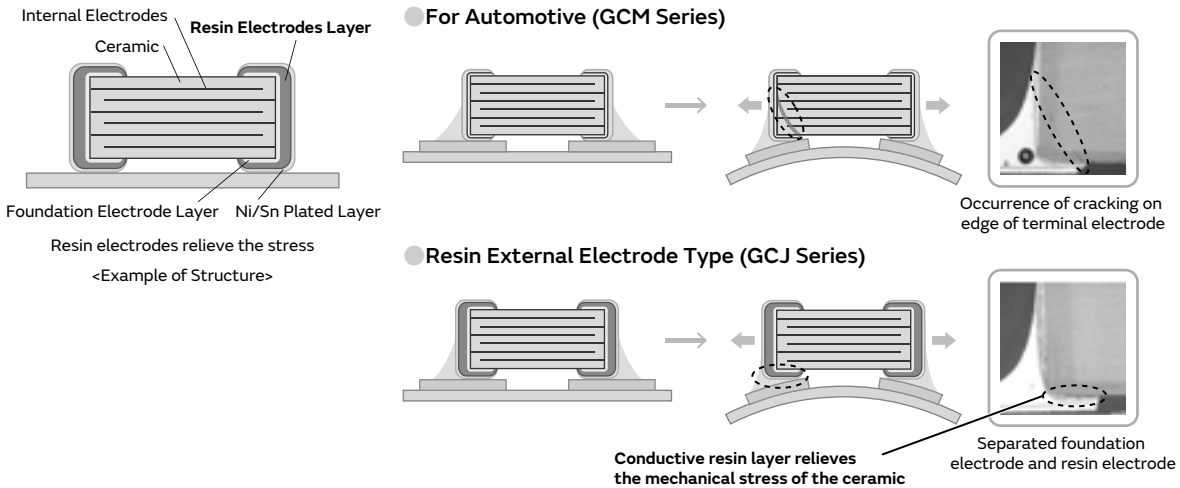

② Suppresses the occurrence of cracking caused by deflection stress at the time of board mounting, etc.

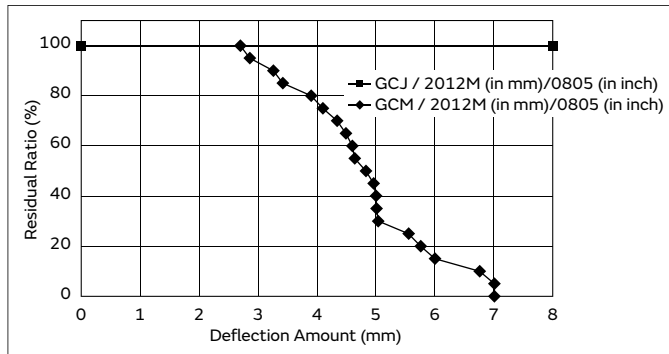

Due to the specification of the measuring instrument, measurements can be performed up to 8mm.

③ Ideal for automotive.

This AEC-Q200 conforming product is ideal for the ECU, control circuits of headlights, etc. of automotive.

Specifications

Size	1.6×0.8mm to 5.7×5.0mm
Rated Voltage	6.3Vdc to 1000Vdc
Capacitance	220pF to 47μF
Main Applications	Battery Lines and Powertrains for automotive

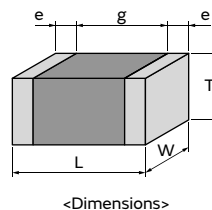

GR7 Series
 GCM Series
 GC3 Series
 GCD Series
 GCE Series
 GCG Series
 GCJ Series
 KCM Series
 KC3 Series
 KCA Series
 NMF Series
 ⚠Caution/Notice

GCJ Series High Dielectric Constant Type **Power-train** **AEC-Q200** **Fail safe** **Deflecting crack** Part Number List

1.6×0.8mm

T max.	Rated Voltage	TC Code	Cap.	Tol.	Part Number	
0.9mm	100Vdc	X8R	1000pF	±10%	GCJ188R92A102KA01#	
			1200pF	±10%	GCJ188R92A122KA01#	
			1500pF	±10%	GCJ188R92A152KA01#	
			1800pF	±10%	GCJ188R92A182KA01#	
			2200pF	±10%	GCJ188R92A222KA01#	
			2700pF	±10%	GCJ188R92A272KA01#	
			3300pF	±10%	GCJ188R92A332KA01#	
			3900pF	±10%	GCJ188R92A392KA01#	
			4700pF	±10%	GCJ188R92A472KA01#	
			5600pF	±10%	GCJ188R92A562KA01#	
			6800pF	±10%	GCJ188R92A682KA01#	
			8200pF	±10%	GCJ188R92A822KA01#	
			10000pF	±10%	GCJ188R92A103KA01#	
			12000pF	±10%	GCJ188R92A123KA01#	
			15000pF	±10%	GCJ188R92A153KA01#	
			18000pF	±10%	GCJ188R92A183KA01#	
			22000pF	±10%	GCJ188R92A223KA01#	
			27000pF	±10%	GCJ188R92A273KA01#	
			33000pF	±10%	GCJ188R92A333KA01#	
			39000pF	±10%	GCJ188R92A393KA01#	
			47000pF	±10%	GCJ188R92A473KA01#	
			56000pF	±10%	GCJ188R92A563KA01#	
			68000pF	±10%	GCJ188R92A683KA01#	
			X7R	1000pF	±10%	GCJ188R72A102KA01#
				1200pF	±10%	GCJ188R72A122KA01#
				1500pF	±10%	GCJ188R72A152KA01#
				1800pF	±10%	GCJ188R72A182KA01#
				2200pF	±10%	GCJ188R72A222KA01#
				2700pF	±10%	GCJ188R72A272KA01#
				3300pF	±10%	GCJ188R72A332KA01#
				3900pF	±10%	GCJ188R72A392KA01#
				4700pF	±10%	GCJ188R72A472KA01#
				5600pF	±10%	GCJ188R72A562KA01#
				6800pF	±10%	GCJ188R72A682KA01#
				8200pF	±10%	GCJ188R72A822KA01#
			10000pF	±10%	GCJ188R72A103KA01#	
		12000pF	±10%	GCJ188R72A123KA01#		
		15000pF	±10%	GCJ188R72A153KA01#		
		18000pF	±10%	GCJ188R72A183KA01#		
		22000pF	±10%	GCJ188R72A223KA01#		
		0.10μF	±10%	GCJ188R72A104KA01#		
		50Vdc	X8L	1000pF	±10%	GCJ188L81H102KA01#
				1200pF	±10%	GCJ188L81H122KA01#
				1500pF	±10%	GCJ188L81H152KA01#
				1800pF	±10%	GCJ188L81H182KA01#
				2200pF	±10%	GCJ188L81H222KA01#
				2700pF	±10%	GCJ188L81H272KA01#
				3300pF	±10%	GCJ188L81H332KA01#
3900pF	±10%			GCJ188L81H392KA01#		
4700pF	±10%			GCJ188L81H472KA01#		
5600pF	±10%			GCJ188L81H562KA01#		
6800pF	±10%			GCJ188L81H682KA01#		

T max.	Rated Voltage	TC Code	Cap.	Tol.	Part Number		
0.9mm	50Vdc	X8L	8200pF	±10%	GCJ188L81H822KA01#		
			10000pF	±10%	GCJ188L81H103KA01#		
			12000pF	±10%	GCJ188L81H123KA01#		
			15000pF	±10%	GCJ188L81H153KA01#		
			18000pF	±10%	GCJ188L81H183KA01#		
			22000pF	±10%	GCJ188L81H223KA01#		
			X8R	4700pF	±10%	GCJ188R91H472KA01#	
				10000pF	±10%	GCJ188R91H103KA01#	
				0.10μF	±10%	GCJ188R91H104KA01#	
				0.12μF	±10%	GCJ188R91H124KA01#	
				0.15μF	±10%	GCJ188R91H154KA01#	
				0.18μF	±10%	GCJ188R91H184KA01#	
				0.22μF	±10%	GCJ188R91H224KA01#	
				X7R	1000pF	±10%	GCJ188R71H102KA01#
					1200pF	±10%	GCJ188R71H122KA01#
					1500pF	±10%	GCJ188R71H152KA01#
			1800pF		±10%	GCJ188R71H182KA01#	
			2200pF		±10%	GCJ188R71H222KA01#	
		2700pF	±10%		GCJ188R71H272KA01#		
		3300pF	±10%		GCJ188R71H332KA01#		
		3900pF	±10%		GCJ188R71H392KA01#		
		4700pF	±10%		GCJ188R71H472KA01#		
		5600pF	±10%		GCJ188R71H562KA01#		
		6800pF	±10%	GCJ188R71H682KA01#			
		8200pF	±10%	GCJ188R71H822KA01#			
		10000pF	±10%	GCJ188R71H103KA01#			
		12000pF	±10%	GCJ188R71H123KA01#			
		15000pF	±10%	GCJ188R71H153KA01#			
		18000pF	±10%	GCJ188R71H183KA01#			
		22000pF	±10%	GCJ188R71H223KA01#			
		33000pF	±10%	GCJ188R71H333KA12#			
		39000pF	±10%	GCJ188R71H393KA12#			
		47000pF	±10%	GCJ188R71H473KA12#			
		56000pF	±10%	GCJ188R71H563KA12#			
		68000pF	±10%	GCJ188R71H683KA12#			
		82000pF	±10%	GCJ188R71H823KA12#			
		0.10μF	±10%	GCJ188R71H104KA12#			
		0.15μF	±10%	GCJ188R71H154KA01#			
		0.22μF	±10%	GCJ188R71H224KA01#			
		35Vdc	X8L	33000pF	±10%	GCJ188L8YA333KA01#	
				39000pF	±10%	GCJ188L8YA393KA01#	
				56000pF	±10%	GCJ188L8YA563KA01#	
				68000pF	±10%	GCJ188L8YA683KA01#	
		25Vdc	X8L	33000pF	±10%	GCJ188L81E333KA01#	
				39000pF	±10%	GCJ188L81E393KA01#	
				56000pF	±10%	GCJ188L81E563KA01#	
				68000pF	±10%	GCJ188L81E683KA01#	
				82000pF	±10%	GCJ188L81E823KA01#	
0.15μF	±10%			GCJ188L81E154KA01#			
0.18μF	±10%			GCJ188L81E184KA01#			
0.22μF	±10%			GCJ188L81E224KA01#			
X8R	0.33μF			±10%	GCJ188R91E334KA01#		
	0.39μF			±10%	GCJ188R91E394KA01#		
	0.47μF		±10%	GCJ188R91E474KA01#			

Part number # indicates the package specification code.

GRT Series
 GCM Series
 GC3 Series
 GCD Series
 GCE Series
 GCG Series
 GCJ Series
 KCM Series
 KC3 Series
 KCA Series
 NMF Series
 ⚠Caution/ Notice

GCJ Series High Dielectric Constant Type Power-train AEC-Q200 Fail safe Deflecting crack Part Number List

(→ 1.6×0.8mm)

T max.	Rated Voltage	TC Code	Cap.	Tol.	Part Number
0.9mm	25Vdc	X7R	1000pF	±10%	GCJ188R71E102KA01#
			1200pF	±10%	GCJ188R71E122KA01#
			1500pF	±10%	GCJ188R71E152KA01#
			1800pF	±10%	GCJ188R71E182KA01#
			2200pF	±10%	GCJ188R71E222KA01#
			2700pF	±10%	GCJ188R71E272KA01#
			3300pF	±10%	GCJ188R71E332KA01#
			3900pF	±10%	GCJ188R71E392KA01#
			4700pF	±10%	GCJ188R71E472KA01#
			5600pF	±10%	GCJ188R71E562KA01#
			6800pF	±10%	GCJ188R71E682KA01#
			8200pF	±10%	GCJ188R71E822KA01#
			10000pF	±10%	GCJ188R71E103KA01#
			12000pF	±10%	GCJ188R71E123KA01#
			15000pF	±10%	GCJ188R71E153KA01#
			18000pF	±10%	GCJ188R71E183KA01#
			22000pF	±10%	GCJ188R71E223KA01#
			27000pF	±10%	GCJ188R71E273KA01#
			33000pF	±10%	GCJ188R71E333KA01#
			39000pF	±10%	GCJ188R71E393KA01#
			47000pF	±10%	GCJ188R71E473KA01#
	56000pF	±10%	GCJ188R71E563KA12#		
	68000pF	±10%	GCJ188R71E683KA12#		
	82000pF	±10%	GCJ188R71E823KA12#		
	0.10μF	±10%	GCJ188R71E104KA12#		
	0.12μF	±10%	GCJ188R71E124KA01#		
	0.15μF	±10%	GCJ188R71E154KA01#		
	0.18μF	±10%	GCJ188R71E184KA12#		
	0.22μF	±10%	GCJ188R71E224KA12#		
	1.0μF	±10%	GCJ188R71E105KA01#		
	16Vdc	X8L	33000pF	±10%	GCJ188L81C333KA01#
			39000pF	±10%	GCJ188L81C393KA01#
			47000pF	±10%	GCJ188L81C473KA01#
56000pF			±10%	GCJ188L81C563KA01#	
68000pF			±10%	GCJ188L81C683KA01#	
82000pF			±10%	GCJ188L81C823KA01#	
0.10μF			±10%	GCJ188L81C104KA01#	
0.12μF			±10%	GCJ188L81C124KA01#	
0.15μF			±10%	GCJ188L81C154KA01#	
0.18μF			±10%	GCJ188L81C184KA01#	
0.22μF			±10%	GCJ188L81C224KA01#	
X7R			10000pF	±10%	GCJ188R71C103KA01#
		27000pF	±10%	GCJ188R71C273KA01#	
		33000pF	±10%	GCJ188R71C333KA01#	
		39000pF	±10%	GCJ188R71C393KA01#	
		47000pF	±10%	GCJ188R71C473KA01#	
		56000pF	±10%	GCJ188R71C563KA01#	
		68000pF	±10%	GCJ188R71C683KA01#	
		82000pF	±10%	GCJ188R71C823KA01#	
		0.10μF	±10%	GCJ188R71C104KA01#	
		0.12μF	±10%	GCJ188R71C124KA01#	
		0.15μF	±10%	GCJ188R71C154KA01#	
		0.18μF	±10%	GCJ188R71C184KA01#	
0.22μF		±10%	GCJ188R71C224KA01#		

T max.	Rated Voltage	TC Code	Cap.	Tol.	Part Number
0.9mm	16Vdc	X7R	0.27μF	±10%	GCJ188R71C274KA01#
			0.33μF	±10%	GCJ188R71C334KA01#
			0.39μF	±10%	GCJ188R71C394KA12#
			0.47μF	±10%	GCJ188R71C474KA12#
			0.12μF	±10%	GCJ188R71A124KA01#
	10Vdc	X7R	0.15μF	±10%	GCJ188R71A154KA01#
			0.18μF	±10%	GCJ188R71A184KA01#
			0.22μF	±10%	GCJ188R71A224KA01#
			2.2μF	±10%	GCJ188R70J225KE01#
			3.3μF	±10%	GCJ188C70J335KE02#
1.0mm	6.3Vdc	X7S	4.7μF	±10%	GCJ188C70J475KE02#

2.0×1.25mm

T max.	Rated Voltage	TC Code	Cap.	Tol.	Part Number		
0.7mm	100Vdc	X7R	1000pF	±10%	GCJ216R72A102KA01#		
			1200pF	±10%	GCJ216R72A122KA01#		
			1500pF	±10%	GCJ216R72A152KA01#		
			1800pF	±10%	GCJ216R72A182KA01#		
			2200pF	±10%	GCJ216R72A222KA01#		
			2700pF	±10%	GCJ216R72A272KA01#		
			3300pF	±10%	GCJ216R72A332KA01#		
			3900pF	±10%	GCJ216R72A392KA01#		
			4700pF	±10%	GCJ216R72A472KA01#		
			5600pF	±10%	GCJ216R72A562KA01#		
			6800pF	±10%	GCJ216R72A682KA01#		
			8200pF	±10%	GCJ216R72A822KA01#		
			10000pF	±10%	GCJ216R72A103KA01#		
			12000pF	±10%	GCJ216R72A123KA01#		
			15000pF	±10%	GCJ216R72A153KA01#		
			18000pF	±10%	GCJ216R72A183KA01#		
			22000pF	±10%	GCJ216R72A223KA01#		
			50Vdc	X7R	330pF	±10%	GCJ216R71H331KA01#
					390pF	±10%	GCJ216R71H391KA01#
					470pF	±10%	GCJ216R71H471KA01#
					560pF	±10%	GCJ216R71H561KA01#
					680pF	±10%	GCJ216R71H681KA01#
	820pF	±10%			GCJ216R71H821KA01#		
	1000pF	±10%			GCJ216R71H102KA01#		
	1200pF	±10%			GCJ216R71H122KA01#		
	1500pF	±10%			GCJ216R71H152KA01#		
	1800pF	±10%			GCJ216R71H182KA01#		
	2200pF	±10%			GCJ216R71H222KA01#		
	2700pF	±10%	GCJ216R71H272KA01#				
	3300pF	±10%	GCJ216R71H332KA01#				
	3900pF	±10%	GCJ216R71H392KA01#				
	4700pF	±10%	GCJ216R71H472KA01#				
	5600pF	±10%	GCJ216R71H562KA01#				
6800pF	±10%	GCJ216R71H682KA01#					
8200pF	±10%	GCJ216R71H822KA01#					
10000pF	±10%	GCJ216R71H103KA01#					
12000pF	±10%	GCJ216R71H123KA01#					
15000pF	±10%	GCJ216R71H153KA01#					

Part number # indicates the package specification code.

GCJ Series High Dielectric Constant Type Part Number List

(→ 2.0×1.25mm)

T max.	Rated Voltage	TC Code	Cap.	Tol.	Part Number	T max.	Rated Voltage	TC Code	Cap.	Tol.	Part Number		
0.7mm	50Vdc	X7R	1800pF	±10%	GCJ216R71H183KA01#	1.45mm	100Vdc	X7R	6800pF	±10%	GCJ21BR72A683KA01#		
			2200pF	±10%	GCJ216R71H223KA01#				8200pF	±10%	GCJ21BR72A823KA01#		
	25Vdc	X7R	470pF	±10%	GCJ216R71E471KA01#				0.10μF	±10%	GCJ21BR72A104KA01#		
			560pF	±10%	GCJ216R71E561KA01#				50Vdc	X8L	2700pF	±10%	GCJ21BL81H273KA01#
			680pF	±10%	GCJ216R71E681KA01#						3300pF	±10%	GCJ21BL81H333KA01#
			820pF	±10%	GCJ216R71E821KA01#						3900pF	±10%	GCJ21BL81H393KA01#
			1000pF	±10%	GCJ216R71E102KA01#						4700pF	±10%	GCJ21BL81H473KA01#
			1200pF	±10%	GCJ216R71E122KA01#						5600pF	±10%	GCJ21BL81H563KA01#
			1500pF	±10%	GCJ216R71E152KA01#						6800pF	±10%	GCJ21BL81H683KA01#
			1800pF	±10%	GCJ216R71E182KA01#						8200pF	±10%	GCJ21BL81H823KA01#
			2200pF	±10%	GCJ216R71E222KA01#		0.10μF	±10%			GCJ21BL81H104KA01#		
			2700pF	±10%	GCJ216R71E272KA01#		X7R	4700pF			±10%	GCJ21BR71H473KA01#	
			3300pF	±10%	GCJ216R71E332KA01#			5600pF			±10%	GCJ21BR71H563KA01#	
			3900pF	±10%	GCJ216R71E392KA01#			6800pF	±10%	GCJ21BR71H683KA01#			
	4700pF	±10%	GCJ216R71E472KA01#	8200pF	±10%			GCJ21BR71H823KA01#					
	5600pF	±10%	GCJ216R71E562KA01#	0.10μF	±10%			GCJ21BR71H104KA01#					
	6800pF	±10%	GCJ216R71E682KA01#	0.12μF	±10%			GCJ21BR71H124KA01#					
	8200pF	±10%	GCJ216R71E822KA01#	0.15μF	±10%			GCJ21BR71H154KA01#					
	10000pF	±10%	GCJ216R71E103KA01#	0.18μF	±10%			GCJ21BR71H184KA01#					
	12000pF	±10%	GCJ216R71E123KA01#	0.22μF	±10%			GCJ21BR71H224KA01#					
0.95mm	100Vdc	X7R	220pF	±10%	GCJ219R72A221KA01#	0.47μF		±10%	GCJ21BR71H474KA12#				
			270pF	±10%	GCJ219R72A271KA01#	1.0μF	±10%	GCJ21BR71H105KA01#					
			330pF	±10%	GCJ219R72A331KA01#	35Vdc	X8L	0.12μF	±10%	GCJ21BL8YA124KA01#			
			390pF	±10%	GCJ219R72A391KA01#			0.15μF	±10%	GCJ21BL8YA154KA01#			
			470pF	±10%	GCJ219R72A471KA01#			0.18μF	±10%	GCJ21BL8YA184KA01#			
			560pF	±10%	GCJ219R72A561KA01#			0.22μF	±10%	GCJ21BL8YA224KA01#			
			680pF	±10%	GCJ219R72A681KA01#			0.33μF	±10%	GCJ21BL8YA334KA01#			
			820pF	±10%	GCJ219R72A821KA01#			0.47μF	±10%	GCJ21BL8YA474KA01#			
			2700pF	±10%	GCJ219R72A273KA01#			25Vdc	X8L	0.12μF	±10%	GCJ21BL81E124KA01#	
			3300pF	±10%	GCJ219R72A333KA01#					0.15μF	±10%	GCJ21BL81E154KA01#	
	3900pF	±10%	GCJ219R72A393KA01#	0.18μF	±10%					GCJ21BL81E184KA01#			
	50Vdc	X7R	2700pF	±10%	GCJ219R71H273KA01#					0.22μF	±10%	GCJ21BL81E224KA01#	
			3300pF	±10%	GCJ219R71H333KA01#	0.27μF	±10%			GCJ21BL81E274KA01#			
	25Vdc	X7R	3900pF	±10%	GCJ219R71H393KA01#	0.33μF	±10%			GCJ21BL81E334KA01#			
			0.33μF	±10%	GCJ219R71H334KA12#	0.39μF	±10%			GCJ21BL81E394KA01#			
			15000pF	±10%	GCJ219R71E153KA01#	0.47μF	±10%			GCJ21BL81E474KA01#			
			18000pF	±10%	GCJ219R71E183KA01#	0.68μF	±10%			GCJ21BL81E684KA01#			
			22000pF	±10%	GCJ219R71E223KA01#	0.82μF	±10%			GCJ21BL81E824KA01#			
			0.33μF	±10%	GCJ219R71E334KA01#	1.0μF	±10%	GCJ21BL81E105KA01#					
			0.47μF	±10%	GCJ219R71E474KA12#	X7R	2700pF	±10%	GCJ21BR71E273KA01#				
16Vdc			X7R	0.68μF	±10%		GCJ219R71C684KA01#	3300pF	±10%	GCJ21BR71E333KA01#			
	0.82μF	±10%		GCJ219R71C824KA01#	3900pF		±10%	GCJ21BR71E393KA01#					
1.0mm	250Vdc	X7R	1000pF	±10%	GCJ21AR72E102KXJ1#		4700pF	±10%	GCJ21BR71E473KA01#				
			1500pF	±10%	GCJ21AR72E152KXJ1#		5600pF	±10%	GCJ21BR71E563KA01#				
			2200pF	±10%	GCJ21AR72E222KXJ1#		6800pF	±10%	GCJ21BR71E683KA01#				
			3300pF	±10%	GCJ21AR72E332KXJ1#		8200pF	±10%	GCJ21BR71E823KA01#				
			4700pF	±10%	GCJ21AR72E472KXJ1#		0.10μF	±10%	GCJ21BR71E104KA01#				
			6800pF	±10%	GCJ21AR72E682KXJ1#		0.27μF	±10%	GCJ21BR71E274KA01#				
			1.45mm	250Vdc	X7R		1000pF	±10%	GCJ21BR72E103KXJ3#	0.39μF	±10%	GCJ21BR71E394KA01#	
						1500pF	±10%	GCJ21BR72E153KXJ3#	0.56μF	±10%	GCJ21BR71E564KA12#		
100Vdc	X7R	2200pF	±10%	GCJ21BR72E223KXJ3#	0.68μF	±10%	GCJ21BR71E684KA12#						
		4700pF	±10%	GCJ21BR72A473KA01#	0.82μF	±10%	GCJ21BR71E824KA12#						
		5600pF	±10%	GCJ21BR72A563KA01#	1.0μF	±10%	GCJ21BR71E105KA12#						
									1.5μF	±10%	GCJ21BR71E155KA01#		

Part number # indicates the package specification code.

GRT Series
 GCM Series
 GC3 Series
 GCD Series
 GCE Series
 GCG Series
 GCJ Series
 KCM Series
 KC3 Series
 KCA Series
 NMF Series
 ⚠Caution/ Notice

GCJ Series High Dielectric Constant Type Part Number List

(→ 2.0×1.25mm)

T max.	Rated Voltage	TC Code	Cap.	Tol.	Part Number	
1.45mm	25Vdc	X7R	2.2μF	±10%	GCJ21BR71E225KA01#	
		X8L	0.56μF	±10%	GCJ21BL81C564KA01#	
	16Vdc	X8L	0.68μF	±10%	GCJ21BL81C684KA01#	
			0.82μF	±10%	GCJ21BL81C824KA01#	
			1.0μF	±10%	GCJ21BL81C105KA01#	
			X7R	0.27μF	±10%	GCJ21BR71C274KA01#
			0.33μF	±10%	GCJ21BR71C334KA01#	
	10Vdc	X7R	0.39μF	±10%	GCJ21BR71C394KA01#	
			0.47μF	±10%	GCJ21BR71C474KA01#	
			0.56μF	±10%	GCJ21BR71C564KA01#	
			1.0μF	±10%	GCJ21BR71C105KA01#	
			2.2μF	±10%	GCJ21BR71C225KA13#	
			4.7μF	±10%	GCJ21BR71C475KA01#	
			10μF	±10%	GCJ21BR71A106KE01#	
	1.5mm	100Vdc	X7S	1.0μF	±10%	GCJ21BC72A105KE02#

3.2×1.6mm

T max.	Rated Voltage	TC Code	Cap.	Tol.	Part Number
0.95mm	100Vdc	X7R	0.10μF	±10%	GCJ319R72A104KA01#
		X7R	0.10μF	±10%	GCJ319R71H104KA01#
	50Vdc	X7R	0.12μF	±10%	GCJ319R71H124KA01#
1.25mm	1000Vdc	X7R	1000pF	±10%	GCJ31BR73A102KXJ1#
			1500pF	±10%	GCJ31BR73A152KXJ1#
			2200pF	±10%	GCJ31BR73A222KXJ1#
			3300pF	±10%	GCJ31BR73A332KXJ1#
			4700pF	±10%	GCJ31BR73A472KXJ1#
	630Vdc	X7R	1000pF	±10%	GCJ31BR72J102KXJ1#
			1500pF	±10%	GCJ31BR72J152KXJ1#
			2200pF	±10%	GCJ31BR72J222KXJ1#
			3300pF	±10%	GCJ31BR72J332KXJ1#
			4700pF	±10%	GCJ31BR72J472KXJ1#
			6800pF	±10%	GCJ31BR72J682KXJ1#
			10000pF	±10%	GCJ31BR72J103KXJ1#
	250Vdc	X7R	15000pF	±10%	GCJ31BR72E153KXJ1#
			22000pF	±10%	GCJ31BR72E223KXJ1#
			68000pF	±10%	GCJ31BR72E683KXJ1#
1.35mm	100Vdc	X7R	0.15μF	±10%	GCJ31MR72A154KA01#
			0.18μF	±10%	GCJ31MR72A184KA01#
			0.22μF	±10%	GCJ31MR72A224KA01#
	50Vdc	X7R	0.15μF	±10%	GCJ31MR71H154KA01#
			0.18μF	±10%	GCJ31MR71H184KA01#
			0.22μF	±10%	GCJ31MR71H224KA01#
			0.27μF	±10%	GCJ31MR71H274KA01#
			0.33μF	±10%	GCJ31MR71H334KA01#
			0.39μF	±10%	GCJ31MR71H394KA01#
			0.47μF	±10%	GCJ31MR71H474KA01#
			0.56μF	±10%	GCJ31MR71H564KA12#
			0.68μF	±10%	GCJ31MR71H684KA12#
0.82μF			±10%	GCJ31MR71H824KA12#	
1.0μF	±10%	GCJ31MR71H105KA12#			
25Vdc	X7R	0.10μF	±10%	GCJ31MR71E104KA01#	

T max.	Rated Voltage	TC Code	Cap.	Tol.	Part Number		
1.35mm	25Vdc	X7R	0.12μF	±10%	GCJ31MR71E124KA01#		
			0.15μF	±10%	GCJ31MR71E154KA01#		
			0.18μF	±10%	GCJ31MR71E184KA01#		
			0.22μF	±10%	GCJ31MR71E224KA01#		
			1.0μF	±10%	GCJ31MR71E105KA01#		
			1.5μF	±10%	GCJ31MR71E155KA12#		
			2.2μF	±10%	GCJ31MR71E225KA12#		
			3.3μF	±10%	GCJ31MR71E335KA12#		
			16Vdc	X7R	1.0μF	±10%	GCJ31MR71C105KA01#
			1.5μF		±10%	GCJ31MR71C155KA01#	
	1.8mm	1000Vdc	X7R	6800pF	±10%	GCJ31CR73A682KXJ3#	
				10000pF	±10%	GCJ31CR73A103KXJ3#	
		630Vdc	X7R	15000pF	±10%	GCJ31CR72J153KXJ3#	
				22000pF	±10%	GCJ31CR72J223KXJ3#	
		250Vdc	X7R	33000pF	±10%	GCJ31CR72E333KXJ3#	
47000pF	±10%			GCJ31CR72E473KXJ3#			
0.10μF	±10%			GCJ31CR72E104KXJ3#			
1.9mm	100Vdc	X7R	1.0μF	±10%	GCJ31CR72A105KA01#		
			50Vdc	X7R	1.5μF	±10%	GCJ31CR71H155KA12#
					2.2μF	±10%	GCJ31CR71H225KA12#
	35Vdc	X7S	4.7μF	±10%	GCJ31CC71H475KA01#		
			X8L	0.56μF	±10%	GCJ31CL8YA564KA01#	
				0.68μF	±10%	GCJ31CL8YA684KA01#	
				0.82μF	±10%	GCJ31CL8YA824KA01#	
25Vdc	X8L	1.0μF	±10%	GCJ31CL8YA105KA01#			
		0.56μF	±10%	GCJ31CL81E564KA01#			
		0.68μF	±10%	GCJ31CL81E684KA01#			
	X7R	0.82μF	±10%	GCJ31CL81E824KA01#			
		1.0μF	±10%	GCJ31CL81E105KA01#			
		4.7μF	±10%	GCJ31CR71E475KA12#			
16Vdc	X8L	3.3μF	±10%	GCJ31CL81C335KA01#			
		4.7μF	±10%	GCJ31CL81C475KA01#			
	X7R	3.3μF	±10%	GCJ31CR71C335KA01#			
		4.7μF	±10%	GCJ31CR71C475KA01#			
		10μF	±10%	GCJ31CR71C106KA15#			
10Vdc	X7R	6.8μF	±10%	GCJ31CR71A685KA13#			
		10μF	±10%	GCJ31CR71A106KA13#			
		22μF	±10%	GCJ31CR71A226KE01#			
6.3Vdc	X7R	22μF	±10%	GCJ31CR70J226KE01#			
2.0mm	25Vdc	X7S	10μF	±10%	GCJ31CC71E106KA15#		

3.2×2.5mm

T max.	Rated Voltage	TC Code	Cap.	Tol.	Part Number
1.5mm	630Vdc	X7R	6800pF	±10%	GCJ32QR72J682KXJ1#
			10000pF	±10%	GCJ32QR72J103KXJ1#
	250Vdc	X7R	68000pF	±10%	GCJ32QR72E683KXJ1#
			0.15μF	±10%	GCJ32QR72E154KXJ1#
2.0mm	1000Vdc	X7R	15000pF	±10%	GCJ32DR73A153KXJ1#
			22000pF	±10%	GCJ32DR73A223KXJ1#
	630Vdc	X7R	15000pF	±10%	GCJ32DR72J153KXJ1#
			22000pF	±10%	GCJ32DR72J223KXJ1#
			33000pF	±10%	GCJ32DR72J333KXJ1#

Part number # indicates the package specification code.

GRT Series

GCM Series

GC3 Series

GCD Series

GCE Series

GCG Series

GCJ Series

KCM Series

KC3 Series

KCA Series

NMF Series

⚠Caution/
 Notice

GCJ Series High Dielectric Constant Type Part Number List

(→ 3.2×2.5mm)

T max.	Rated Voltage	TC Code	Cap.	Tol.	Part Number
2.0mm	630Vdc	X7R	47000pF	±10%	GCJ32DR72J473KXJ1#
	250Vdc	X7R	0.10μF	±10%	GCJ32DR72E104KXJ1#
			0.22μF	±10%	GCJ32DR72E224KXJ1#
2.3mm	100Vdc	X7R	2.2μF	±10%	GCJ32DR72A225KA01#
		X7S	4.7μF	±10%	GCJ32DC72A475KE01#
2.8mm	50Vdc	X7R	4.7μF	±10%	GCJ32ER71H475KA12#
		X7S	10μF	±10%	GCJ32EC71H106KA01#
	25Vdc	X8L	4.7μF	±10%	GCJ32EL81E475KA01#
	16Vdc	X7R	22μF	±10%	GCJ32ER71C226KE01#
	6.3Vdc	X7R	47μF	±10%	GCJ32ER70J476KE01#

4.5×3.2mm

T max.	Rated Voltage	TC Code	Cap.	Tol.	Part Number
1.5mm	630Vdc	X7R	68000pF	±10%	GCJ43QR72J683KXJ1#
	250Vdc	X7R	0.15μF	±10%	GCJ43QR72E154KXJ1#
2.0mm	1000Vdc	X7R	33000pF	±10%	GCJ43DR73A333KXJ1#
			47000pF	±10%	GCJ43DR73A473KXJ1#
	630Vdc	X7R	33000pF	±10%	GCJ43DR72J333KXJ1#
			47000pF	±10%	GCJ43DR72J473KXJ1#
			0.10μF	±10%	GCJ43DR72J104KXJ1#
	250Vdc	X7R	0.22μF	±10%	GCJ43DR72E224KXJ1#
			0.33μF	±10%	GCJ43DR72E334KXJ1#
			0.47μF	±10%	GCJ43DR72E474KXJ1#

5.7×5.0mm

T max.	Rated Voltage	TC Code	Cap.	Tol.	Part Number
2.0mm	1000Vdc	X7R	68000pF	±10%	GCJ55DR73A683KXJ1#
			0.10μF	±10%	GCJ55DR73A104KXJ1#
	630Vdc	X7R	0.10μF	±10%	GCJ55DR72J104KXJ1#
			0.15μF	±10%	GCJ55DR72J154KXJ1#
			0.22μF	±10%	GCJ55DR72J224KXJ1#
	250Vdc	X7R	0.33μF	±10%	GCJ55DR72E334KXJ1#
			0.47μF	±10%	GCJ55DR72E474KXJ1#
			0.68μF	±10%	GCJ55DR72E684KXJ1#
			1.0μF	±10%	GCJ55DR72E105KXJ1#

Metal Terminal Type Monolithic Ceramic Capacitors for Automotive

KCM Series



Bonding the metal terminals to external electrodes solves design issues by mounting large size MLCC!

Features

① **Bond metal terminals to the external electrodes of chips.**

The stress applied to the chip is relieved by the elastic action of the metal terminal.

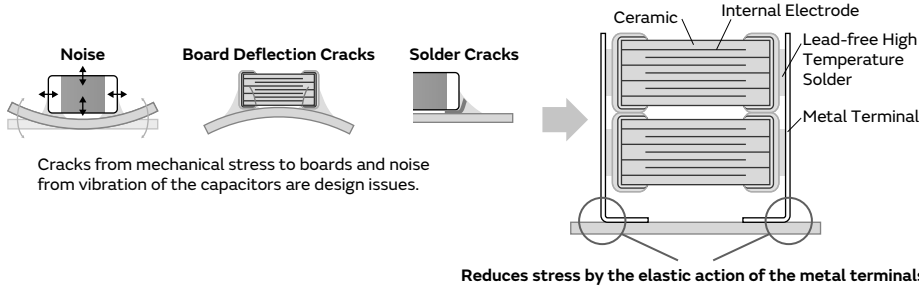

② **Substantially reduces noise, board deflection cracks and soldering cracks.**

This product is not damaged even with a board deflection of 6 mm.
 Solder cracks do not occur even with 2,000 cycles of heat stress.

● **Comparison of Noise Reduction Effects**

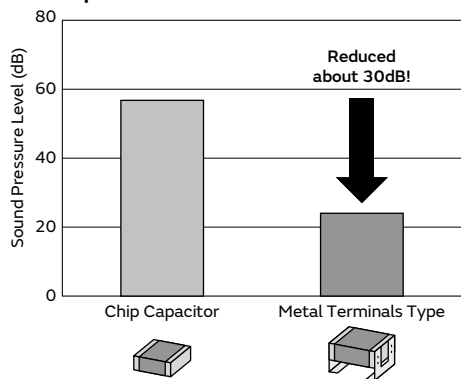

Evaluation Items: 5750 (in mm)/2220 (in inch) size/DC630V/220nF
 Test Method: DC50V, AC10Vp-p/3kHz
 Test Board: Glass Epoxy Board (T=1.6mm)
 Test Quantity: 3pc
 Distance Between Microphone and Board: 3mm

Note: Results Using Murata's Evaluation Board

● **Reduces Stress Caused by Board Deflection**

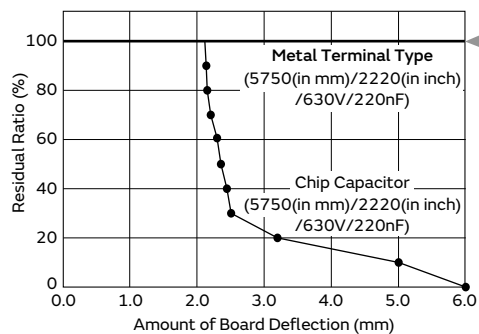

No damage, even with 6 mm board deflection!!

● **Suppresses Solder Cracks Caused by Heat Stress**

Chip Size	Chip Only (5750 (in mm)/2220 (in inch) size)		Metal Terminal Type (5750 (in mm)/2220 (in inch) size)	
1000 Cycles				
2000 Cycles				

Compared with chips only, this product is excellent in solder cracking resistance.

Test Condition: -55 to +125°C, 5min., (Liquid Phase)
 Board Used: Glass Epoxy Board (FR-4)

GRT Series

GCM Series

GC3 Series

GCD Series

GCE Series

GCG Series

GCJ Series

KCM Series

KC3 Series

KCA Series

NMF Series

Caution/
 Notice

③ **2 chips can be stacked.**

Realize large capacity by stacking 2 capacitors.

Specifications

Size	6.1×5.3mm
Rated Voltage	25Vdc to 100Vdc
Capacitance	4.7μF to 68μF
Main Applications	For drive system control of engine ECU For other drive system controls and safety devices

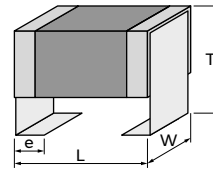

<Dimensions>

KCM Series High Dielectric Constant Type Part Number List

6.1×5.3mm

T max.	Rated Voltage	TC Code	Cap.	Tol.	Part Number
3.0mm	100Vdc	X7R	4.7μF	±10%	KCM55LR72A475KH01#
	63Vdc	X7R	4.7μF	±10%	KCM55LR71J475KH01#
	50Vdc	X7R	4.7μF	±10%	KCM55LR71H475KH01#
			10μF	±10%	KCM55LR71H106KH01#
	35Vdc	X7R	10μF	±10%	KCM55LR7YA106KH01#
			15μF	±10%	KCM55LR7YA156KH01#
25Vdc	X7R	15μF	±10%	KCM55LR71E156KH01#	
3.9mm	100Vdc	X7R	6.8μF	±10%	KCM55QR72A685KH01#
			10μF	±10%	KCM55QR72A106KH01#
	63Vdc	X7R	10μF	±10%	KCM55QR71J106KH01#
	50Vdc	X7R	17μF	±10%	KCM55QR71H176KH01#
	35Vdc	X7R	17μF	±10%	KCM55QR7YA176KH01#
			22μF	±10%	KCM55QR7YA226KH01#
	25Vdc	X7R	22μF	±10%	KCM55QR71E226KH01#
			33μF	±10%	KCM55QR71E336KH01#
5.0mm	100Vdc	X7R	10μF	±20%	KCM55TR72A106MH01#
	50Vdc	X7R	22μF	±20%	KCM55TR71H226MH01#
	35Vdc	X7R	22μF	±20%	KCM55TR7YA226MH01#
			33μF	±20%	KCM55TR7YA336MH01#
	25Vdc	X7R	33μF	±20%	KCM55TR71E336MH01#
6.7mm	100Vdc	X7R	15μF	±20%	KCM55WR72A156MH01#
			22μF	±20%	KCM55WR72A226MH01#
	63Vdc	X7R	22μF	±20%	KCM55WR71J226MH01#
	50Vdc	X7R	33μF	±20%	KCM55WR71H336MH01#
	35Vdc	X7R	47μF	±20%	KCM55WR7YA476MH01#
	25Vdc	X7R	47μF	±20%	KCM55WR71E476MH01#
			68μF	±20%	KCM55WR71E686MH01#

GRT Series
 GCM Series
 GC3 Series
 GCD Series
 GCE Series
 GCG Series
 GCJ Series
 KCM Series
 KC3 Series
 KCA Series
 NMF Series
 △Caution/Notice

High Effective Capacitance & High Allowable Ripple Current Metal Terminal Type Monolithic Ceramic Capacitor for Automotive

KC3 Series



Bonding the metal terminals to external electrodes solves design issues by mounting large size MLCC!

Features

1 Bond Metal Terminals to External Electrodes of Chips

This product has high resistance to heat and mechanical impact and greatly reduces acoustic noise of boards by ceramics.

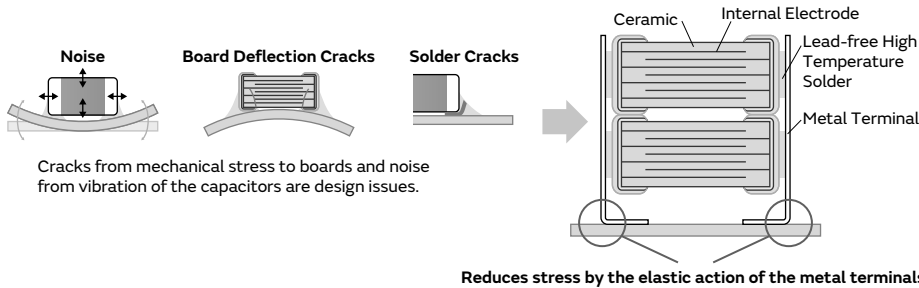

2 Stacking of Chips

Achieve high capacity by stacking 2 capacitors.

Comparison of Noise Reduction Effects

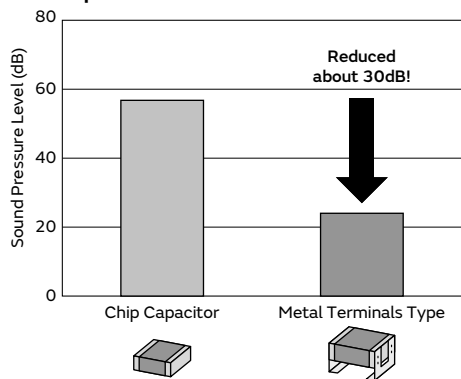

Evaluation Items: 5750 (in mm)/2220 (in inch) size/DC630V/220nF
 Test Method: DC50V, AC10Vp-p/3kHz
 Test Board: Glass Epoxy Board (T=1.6mm)
 Test Quantity: 3pc
 Distance Between Microphone and Board: 3mm

Note: Results Using Murata's Evaluation Board

Reduces Stress Caused by Board Deflection

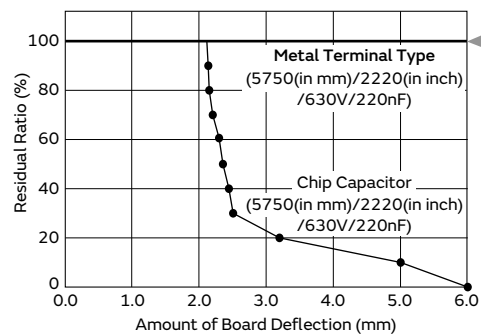

No damage, even with 6 mm board deflection!!

Suppresses Solder Cracks Caused by Heat Stress

Chip Size	Chip Only (5750 (in mm)/2220 (in inch) size)	Metal Terminal Type (5750 (in mm)/2220 (in inch) size)
1000 Cycles		
2000 Cycles		

Compared with chips only, this product is excellent in solder cracking resistance.

Test Condition: -55 to +125°C, 5min., (Liquid Phase)
 Board Used: Glass Epoxy Board (FR-4)

3 Adopted Low Dielectric Constant Materials

Improved effective capacity and ripple resistant performance, compared to conventional products (X7R characteristics).

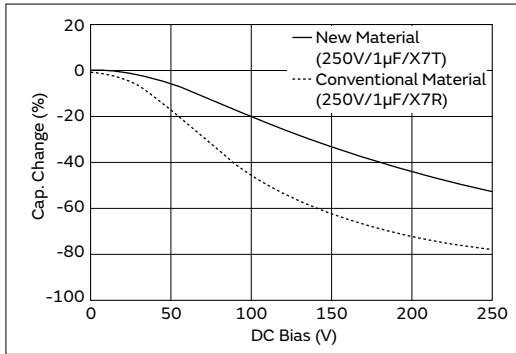

4 2 chips can be stacked

Realize large capacity by stacking 2 capacitors.

Specifications

Size	6.1×5.3mm
Rated Voltage	250Vdc to 630Vdc
Capacitance	0.10µF to 2.2µF
Main Applications	For drive system control of engine ECU For other drive system controls and safety devices



<Dimensions>

GRT Series

GCM Series

GC3 Series

GCD Series

GCE Series

GCG Series

GCJ Series

KCM Series

KC3 Series

KCA Series

NMF Series

⚠Caution/
Notice

KC3 Series High Dielectric Constant Type Part Number List

6.1×5.3mm

T max.	Rated Voltage	TC Code	Cap.	Tol.	Part Number
3.0mm	630Vdc	X7T	0.10μF	±10%	KC355LD72J104KH01#
			0.15μF	±10%	KC355LD72J154KH01#
	450Vdc	X7T	0.22μF	±10%	KC355LD72W224KH01#
			0.33μF	±10%	KC355LD72W334KH01#
			0.47μF	±10%	KC355LD72W474KH01#
	250Vdc	X7T	0.47μF	±10%	KC355LD72E474KH01#
0.68μF			±10%	KC355LD72E684KH01#	
3.9mm	630Vdc	X7T	0.22μF	±10%	KC355QD72J224KH01#
			0.27μF	±10%	KC355QD72J274KH01#
	450Vdc	X7T	0.56μF	±10%	KC355QD72W564KH01#
			250Vdc	X7T	1.0μF
5.0mm	450Vdc	X7T	0.68μF	±20%	KC355TD72W684MH01#
			1.0μF	±20%	KC355TD72W105MH01#
	250Vdc	X7T	1.5μF	±20%	KC355TD72E155MH01#
6.7mm	630Vdc	X7T	0.47μF	±20%	KC355WD72J474MH01#
			0.56μF	±20%	KC355WD72J564MH01#
	450Vdc	X7T	1.2μF	±20%	KC355WD72W125MH01#
			250Vdc	X7T	2.2μF

GRT Series
 GCM Series
 GC3 Series
 GCD Series
 GCE Series
 GCG Series
 GCJ Series
 KCM Series
 KC3 Series
 KCA Series
 NMF Series
 ⚠Caution/ Notice

Safety Standard Certified Metal Terminal Type Monolithic Ceramic Capacitors for Automotive

KCA Series



For Automotive IEC60384-14 X1/Y2 Class Certified Product (Basic insulation product)

Features

① International Standard (IEC60384-14) certified product.

Please down load Safety Standard Certification (Type MF: X1,Y2) from Web site.

② Best suitable for class Y2 capacitors.

AC250V (r.m.s.)-rated voltage, withstand voltage of AC2000V (r.m.s.) guaranteed for 60 seconds.

● OBC (On Board Charger)

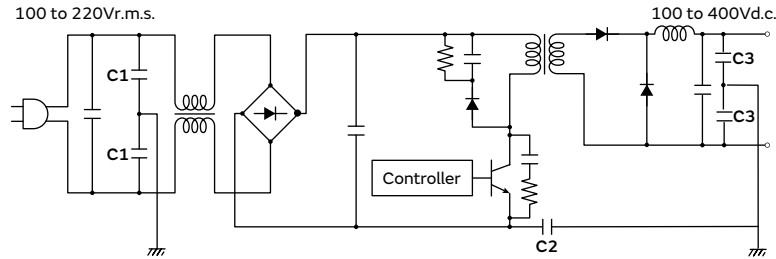

No.	Application
C1	Y Cap (Primary)
C2	Primary-Secondary Coupling
C3	Y Cap (Secondary)

③ Best suitable for DC input common mode noise filters.

DC630V-rated voltage, withstand voltage of DC2700V guaranteed for 60 seconds.

● Inverter

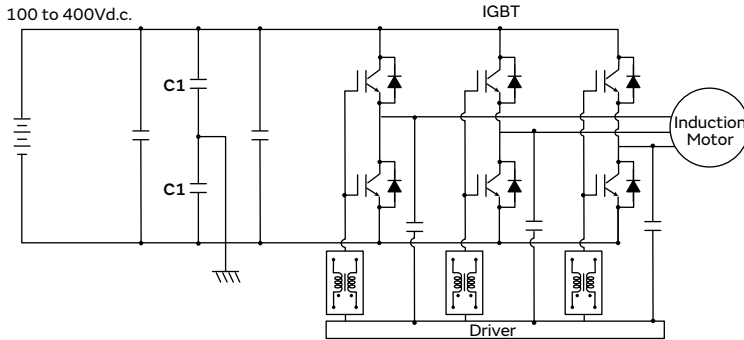

No.	Application
C1	Common mode noise filters

● DC-DC Converter

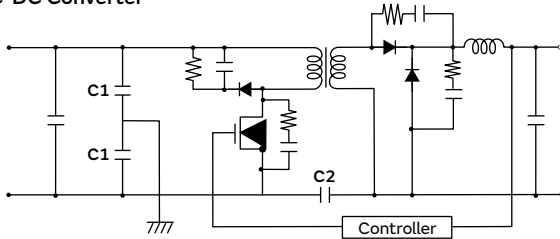

No.	Application
C1	Common mode noise filters
C2	Primary-Secondary Coupling

GRT Series
 GCM Series
 GC3 Series
 GCD Series
 GCE Series
 GCG Series
 GCJ Series
 KCM Series
 KC3 Series
 KCA Series
 NMF Series
 ⚠Caution/Notice

GRT Series

GCM Series

GC3 Series

GCD Series

GCE Series

GCG Series

GCM Series

KCM Series

KC3 Series

KCA Series

NMF Series

⚠Caution/
 Notice

4 Bond metal terminals to the external electrodes of chips.

The stress applied to the chip is relieved by the elastic action of the metal terminal.

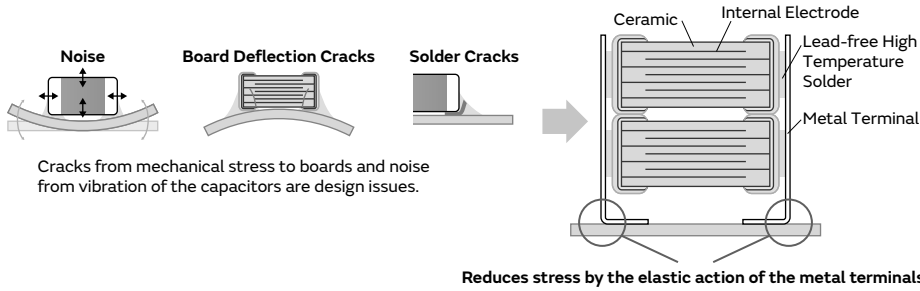

5 Substantially reduces board deflection cracks and soldering cracks.

This product is not damaged even with a board deflection of 6 mm. Solder cracks do not occur even with 2,000 cycles of heat stress.

● Reduces Stress Caused by Board Deflection

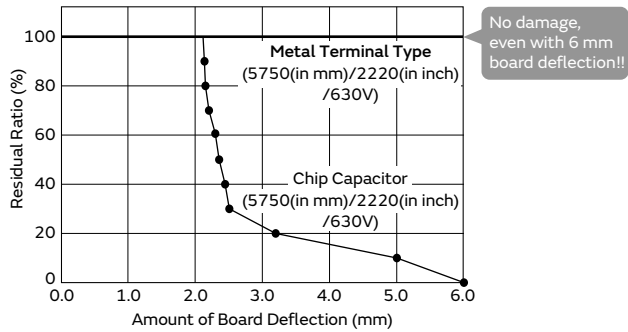

● Suppresses Solder Cracks Caused by Heat Stress

Chip Size	Chip Only (5750 (in mm)/2220 (in inch) size)	Metal Terminal Type (5750 (in mm)/2220 (in inch) size)
1000 Cycles	 ↑Solder Crack	
2000 Cycles	 ↑Solder Crack	

Compared with chips only, this product is excellent in solder cracking resistance.

Test Condition: -55 to +125°C, 5min., (Liquid Phase)
 Board Used: Glass Epoxy Board (FR-4)

6 2 chips can be stacked.

Realize large capacity by stacking 2 capacitors.

Specifications

Size	6.1×5.3mm
Rated Voltage	250Vac
Capacitance	100pF to 10nF
Main Applications	Battery chargers, Inverter, DC-DC converters

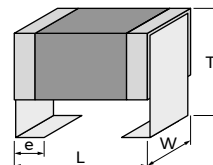

<Dimensions>

KCA Series Temperature Compensating Type Part Number List

6.1×5.3mm

T max.	Rated Voltage	TC Code	Cap.	Tol.	Part Number
3.0mm	250Vac	U2J	100pF	±10%	KCA55L7UMF101KH01#
			150pF	±10%	KCA55L7UMF151KH01#
			220pF	±10%	KCA55L7UMF221KH01#
			330pF	±10%	KCA55L7UMF331KH01#
			470pF	±10%	KCA55L7UMF471KH01#
			680pF	±10%	KCA55L7UMF681KH01#
			1000pF	±10%	KCA55L7UMF102KH01#
			1500pF	±10%	KCA55L7UMF152KH01#
			2200pF	±10%	KCA55L7UMF222KH01#
			3300pF	±10%	KCA55L7UMF332KH01#
3.9mm	250Vac	U2J	4700pF	±10%	KCA55Q7UMF472KH01#
5.0mm	250Vac	U2J	6800pF	±20%	KCA55T7UMF682MH01#
6.7mm	250Vac	U2J	10nF	±20%	KCA55W7UMF103MH01#

GRT Series

GCM Series

GC3 Series

GCD Series

GCE Series

GCG Series

GCJ Series

KCM Series

KC3 Series

KCA Series

NMF Series

⚠Caution/Notice

3 Terminal Low ESL Monolithic Ceramic Capacitors

NFM Series



This is the most suitable Low ESL capacitors for noise measurement and power decoupling of highspeed electrical divides.

Features

① Low ESL

Since the equivalent series inductance (ESL) is low and excellent in high frequency characteristics, this capacitor is suitable for power supply decoupling of high-speed operation electronic equipment.

• 2-terminal Capacitor

Realizes Ultra low ESL by using a extremely shorter high frequency current path

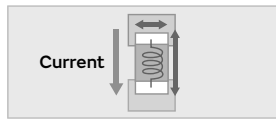
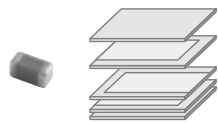

- HOT × long current distance
- GND × Narrow wiring width

• 3-terminal capacitor

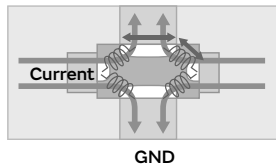
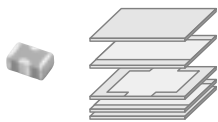

- Short current distance
- Wide wiring width
- Four routes formed in parallel

② Contributes to a reduction in the number of components.

The number of components can be reduced by using low ESL capacitors, while maintaining functions equivalent to 2-terminal capacitor.

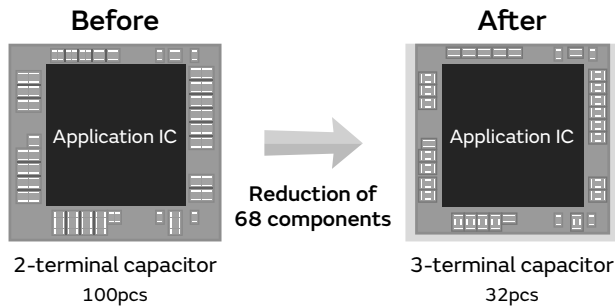

③ Contributes to noise suppression

Example of noise suppression effect

Specifications

Size	2.0×1.25mm to 3.2×1.6mm
Rated Voltage	10Vdc to 100Vdc
Capacitance	220pF to 1.0μF
Main Applications	Safety equipment, Drive system control, Information and Comfort equipment

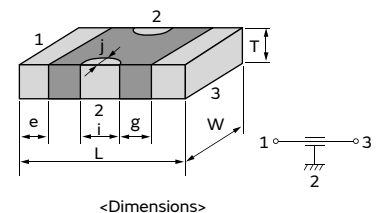

NFM Series    Part Number List

2.0×1.25mm

T max.	Rated Voltage	Cap.	Tol.	Part Number	
0.95mm	50Vdc	220pF	±20%	NFM21HC221R1H3#	
		470pF	±20%	NFM21HC471R1H3#	
		1000pF	±20%	NFM21HC102R1H3#	
		2200pF	±20%	NFM21HC222R1H3#	
		22000pF	±20%	NFM21HC223R1H3#	
	16Vdc	1.0μF	±20%	NFM21HC105R1C3#	
	10Vdc	0.10μF	±20%	NFM21HC104R1A3#	
		0.22μF	±20%	NFM21HC224R1A3#	
		0.47μF	±20%	NFM21HC474R1A3#	

3.2×1.6mm

T max.	Rated Voltage	Cap.	Tol.	Part Number	
1.5mm	100Vdc	10000pF	±20%	NFM31HK103R2A3#	D3
	50Vdc	10000pF	±20%	NFM31HK103R1H3#	D3
		15000pF	±20%	NFM31HK153R1H3#	D3
		22000pF	±20%	NFM31HK223R1H3#	D3
		0.10μF	±20%	NFM31HK104R1H3#	

GRT Series
 GCM Series
 GC3 Series
 GCD Series
 GCE Series
 GCG Series
 GCJ Series
 KCM Series
 KC3 Series
 KCA Series
 NMF Series
 ⚠Caution/Notice

GRT Series

GCM Series

GC3 Series

GCD Series

GCE Series

GCG Series

GCJ Series

KCM Series

KC3 Series

KCA Series

NMF Series

⚠Caution/
 Notice

**GRT, GCM, GC3, GCD, GCE,
 GCG, GCJ, KCM, KC3, KCA**

⚠Caution/Notice



⚠Caution

Notice

Storage and Operation Conditions 65

Rating 65

 1. Temperature Dependent Characteristics 65

 2. Measurement of Capacitance 65

 3. Applied Voltage 66

 4. Type of Applied Voltage and Self-heating Temperature 66

 5. DC Voltage and AC Voltage Characteristics 68

 6. Capacitance Aging 68

 7. Vibration and Shock 69

Soldering and Mounting 69

 1. Mounting Position 69

 2. Information before Mounting 70

 3. Maintenance of the Mounting (pick and place) Machine 70

 4-1. Reflow Soldering 71

 4-2. Flow Soldering 72

 4-3. Correction of Soldered Portion 73

 5. Washing 74

 6. Electrical Test on Printed Circuit Board 74

 7. Printed Circuit Board Cropping 74

 8. Assembly 77

 9. Selection of Conductive Adhesive, Mounting Process, and Bonding Strength 78

 10. Moisture Proof Process 78

 11. Application 78

Other 78

 1. Under Operation of Equipment 78

 2. Other 78

Rating 79

 1. Operating Temperature 79

 2. Atmosphere Surroundings (gaseous and liquid) 79

 3. Piezo-electric Phenomenon 79

Soldering and Mounting 79

 1. PCB Design 79

 1. Notice for Pattern Forms 79

 2. Land Dimensions 80

 3. Board Design 81

 2. Adhesive Application 81

 3. Adhesive Curing 81

 4. Flux for Flow Soldering 82

 5. Flow Soldering 82

 6. Reflow Soldering 82

 7. Washing 82

 8. Coating 82

Other 83

 1. Transportation 83

 2. Characteristics Evaluation in the Actual System 83



Storage and Operation Conditions

1. The performance of chip monolithic ceramic capacitors may be affected by the storage conditions.

1-1. Store the capacitors in the following conditions:

Room Temperature of +5°C to +40°C and a Relative Humidity of 20% to 70%.

- (1) Sunlight, dust, rapid temperature changes, corrosive gas atmosphere, or high temperature and humidity conditions during storage may affect solderability and packaging performance. Therefore, please maintain the storage temperature and humidity. Use the product within six months after receipt, as prolonged storage may cause oxidation of the terminations (outer electrodes).
- (2) Please confirm solderability before using after six months. Store the capacitors without opening the original bag. Even if the storage period is short, do not exceed the specified atmospheric conditions.

1-2. Corrosive gas can react with the termination (external) electrodes or lead wires of capacitors, and result in poor solderability. Do not store the capacitors in an atmosphere consisting of corrosive gas (e.g., hydrogen sulfide, sulfur dioxide, chlorine, ammonia gas, etc.).

1-3. Due to moisture condensation caused by rapid humidity changes, or the photochemical change caused by direct sunlight on the terminal electrodes and/or the resin/epoxy coatings, the solderability and electrical performance may deteriorate. Do not store capacitors under direct sunlight or in high humidity conditions.

<Applicable to GCG Series>

1-4. After unpacking, immediately reseal, or store in a desiccator containing a desiccant.

Rating

1. Temperature Dependent Characteristics

1. The electrical characteristics of a capacitor can change with temperature.

1-1. For capacitors having larger temperature dependency, the capacitance may change with temperature changes.

The following actions are recommended in order to ensure suitable capacitance values.

- (1) Select a suitable capacitance for the operating temperature range.

(2) The capacitance may change within the rated temperature.

When you use a high dielectric constant type capacitor in a circuit that needs a tight (narrow) capacitance tolerance (e.g., a time-constant circuit), please carefully consider the temperature characteristics, and carefully confirm the various characteristics in actual use conditions and the actual system.

[Example of Temperature Characteristics X7R(R7)]

Sample: 0.1μF, Rated Voltage 50VDC

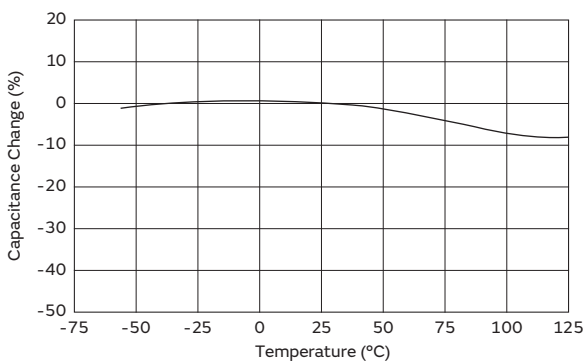

[Example of Temperature Characteristics X5R (R6)]

Sample: 22μF, Rated Voltage 4VDC

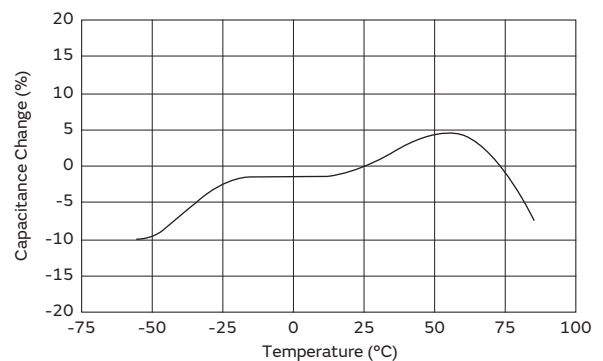

2. Measurement of Capacitance

1. Measure capacitance with the voltage and frequency specified in the product specifications.

1-1. The output voltage of the measuring equipment may decrease occasionally when capacitance is high. Please confirm whether a prescribed measured voltage is impressed to the capacitor.

1-2. The capacitance values of high dielectric constant type capacitors change depending on the AC voltage applied. Please consider the AC voltage characteristics when selecting a capacitor to be used in an AC circuit.

Continued on the following page. ↗

GRT Series
 GCM Series
 GC3 Series
 GCD Series
 GCE Series
 GCG Series
 GCJ Series
 KCM Series
 KC3 Series
 KCA Series
 NMF Series
 ⚠Caution

⚠Caution

Continued from the preceding page. ↘

3. Applied Voltage

1. Do not apply a voltage to the capacitor that exceeds the rated voltage as called out in the specifications.
 - 1-1. Applied voltage between the terminals of a capacitor shall be less than or equal to the rated voltage.
 - (1) When AC voltage is superimposed on DC voltage, the zero-to-peak voltage shall not exceed the rated DC voltage.
 When AC voltage or pulse voltage is applied, the peak-to-peak voltage shall not exceed the rated DC voltage.
 - (2) Abnormal voltages (surge voltage, static electricity, pulse voltage, etc.) shall not exceed the rated DC voltage.

Typical Voltage Applied to the DC Capacitor

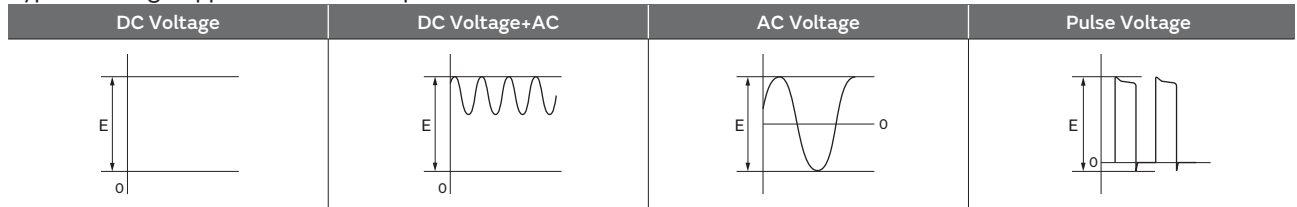

(E: Maximum possible applied voltage.)

- 1-2. Influence of over voltage
 Over voltage that is applied to the capacitor may result in an electrical short circuit caused by the breakdown of the internal dielectric layers. The time duration until breakdown depends on the applied voltage and the ambient temperature.
2. Use a safety standard certified capacitor in a power supply input circuit (AC filter), as it is also necessary to consider the withstand voltage and impulse withstand voltage defined for each device.

4. Type of Applied Voltage and Self-heating Temperature

1. Confirm the operating conditions to make sure that no large current is flowing into the capacitor due to the continuous application of an AC voltage or pulse voltage.
 When a DC rated voltage product is used in an AC voltage circuit or a pulse voltage circuit, the AC current or pulse current will flow into the capacitor; therefore check the self-heating condition.
 Please confirm the surface temperature of the capacitor so that the temperature remains within the upper limits of the operating temperature, including the rise in temperature due to self-heating. When the capacitor is used with a high-frequency voltage or pulse voltage, heat may be generated by dielectric loss.
 <Applicable to Rated Voltage of less than 100VDC>
 - 1-1. The load should be contained to the level such that when measuring at atmospheric temperature of 25°C, the product's self-heating remains below 20°C and the surface temperature of the capacitor in the actual circuit remains within the maximum operating temperature.

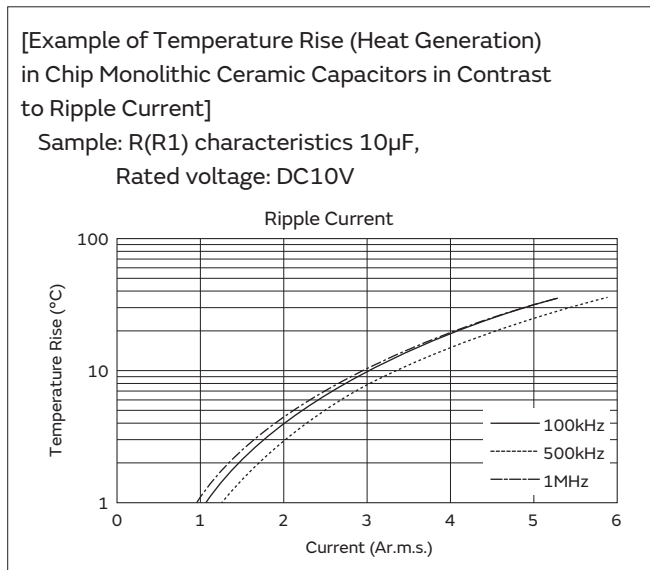



Continued from the preceding page. ↘

<Applicable to Temperature Characteristics X7R(R7), X7T(D7) beyond Rated Voltage of 250VDC>

1-2. The load should be contained so that the self-heating of the capacitor body remains below 20°C, when measuring at an ambient temperature of 25°C. In addition, use a K thermocouple of $\varnothing 0.1\text{mm}$ with less heat capacity when measuring, and measure in a condition where there is no effect from the radiant heat of other components or air flow caused by convection. Excessive generation of heat may cause deterioration of the characteristics and reliability of the capacitor. (Absolutely do not perform measurements while the cooling fan is operating, as an accurate measurement may not be performed.)

<Applicable to Temperature Characteristics U2J(7U), COG(5C) beyond Rated Voltage of 250VDC>

1-3. Since the self-heating is low in the low loss series, the allowable power becomes extremely high compared to the common X7R(R7) characteristics. However, when a load with self-heating of 20°C is applied at the rated voltage, the allowable power may be exceeded. When the capacitor is used in a high-frequency voltage circuit of 1kHz or more, the frequency of the applied voltage should be less than 500kHz sine wave (less than 100kHz for a product with rated voltage of DC3.15kV), to limit the voltage load so that the load remains within the derating shown in the following figure. In the case of non-sine wave, high-frequency components exceeding the fundamental frequency may be included. In such a case, please contact Murata. The excessive generation of heat may cause deterioration of the characteristics and reliability of the capacitor. (Absolutely do not perform measurements while the cooling fan is operating, as an accurate measurement may not be performed.)

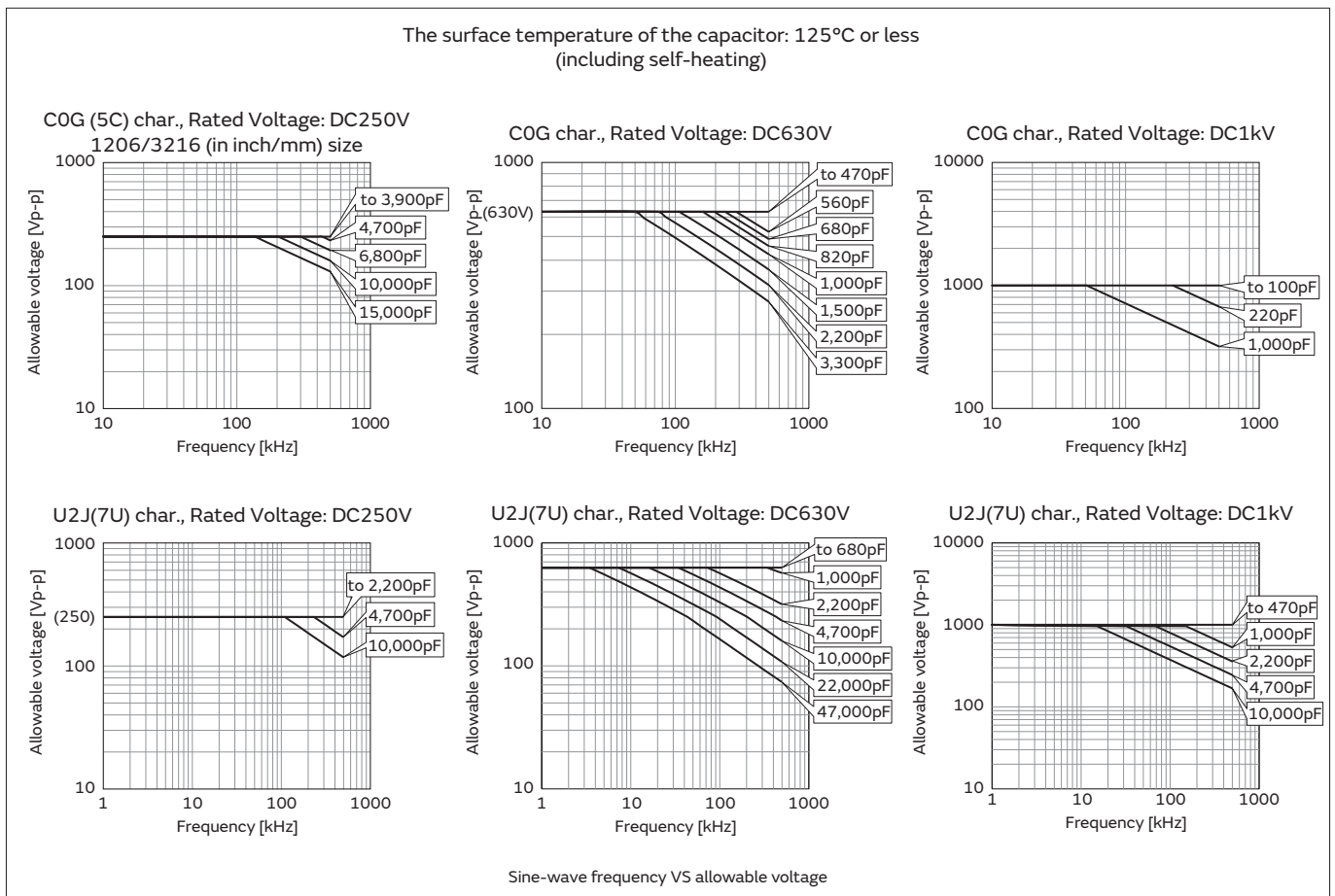

Continued on the following page. ↗

GRT Series

GCM Series

GC3 Series

GCD Series

GCE Series

GCG Series

GCJ Series

KCM Series

KC3 Series

KCA Series

NMF Series



GRT Series
 GCM Series
 GC3 Series
 GCD Series
 GCE Series
 GCG Series
 GCJ Series
 KCM Series
 KC3 Series
 KCA Series
 NMF Series
 ⚠Caution

⚠Caution

Continued from the preceding page. ↘

5. DC Voltage and AC Voltage Characteristics

1. The capacitance value of a high dielectric constant type capacitor changes depending on the DC voltage applied. Please consider the DC voltage characteristics when a capacitor is selected for use in a DC circuit.

1-1. The capacitance of ceramic capacitors may change sharply depending on the applied voltage (see figure). Please confirm the following in order to secure the capacitance.

- (1) Determine whether the capacitance change caused by the applied voltage is within the allowed range.
- (2) In the DC voltage characteristics, the rate of capacitance change becomes larger as voltage increases, even if the applied voltage is below the rated voltage. When a high dielectric constant type capacitor is used in a circuit that requires a tight (narrow) capacitance tolerance (e.g., a time constant circuit), please carefully consider the voltage characteristics, and confirm the various characteristics in the actual operating conditions of the system.

2. The capacitance values of high dielectric constant type capacitors changes depending on the AC voltage applied. Please consider the AC voltage characteristics when selecting a capacitor to be used in an AC circuit.

6. Capacitance Aging

1. The high dielectric constant type capacitors have the Characteristics in which the capacitance value decreases with the passage of time.

When you use high dielectric constant type capacitors in a circuit that needs a tight (narrow) capacitance tolerance (e.g., a time-constant circuit), please carefully consider the characteristics of these capacitors, such as their aging, voltage, and temperature characteristics. In addition, check capacitors using your actual appliances at the intended environment and operating conditions.

[Example of DC Voltage Characteristics]

Sample: R(R1) Characteristics 0.1 μ F,
 Rated Voltage 50VDC

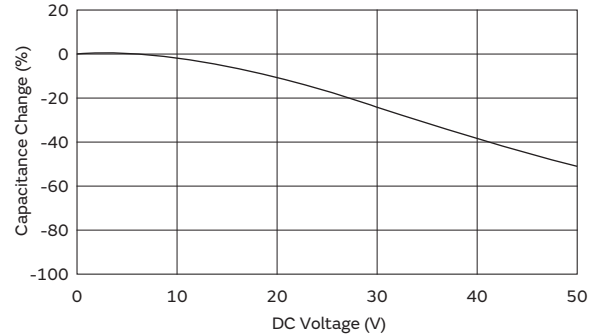

[Example of AC Voltage Characteristics]

Sample: X7R(R7) Characteristics 10 μ F,
 Rated Voltage 6.3VDC

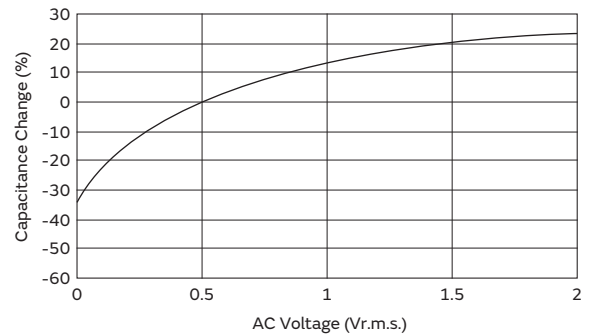

[Example of Change Over Time (Aging Characteristics)]

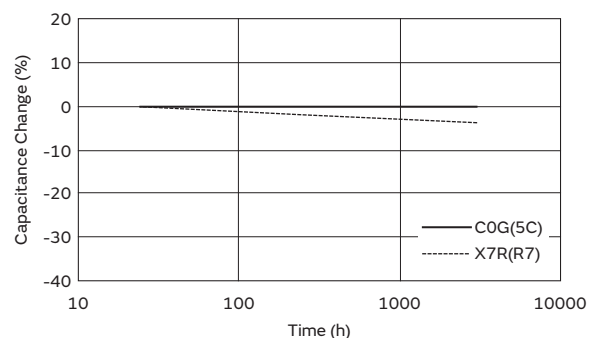

Continued on the following page. ↗

⚠Caution

Continued from the preceding page. ↘

7. Vibration and Shock

1. Please confirm the kind of vibration and/or shock, its condition, and any generation of resonance.
 Please mount the capacitor so as not to generate resonance, and do not allow any impact on the terminals.
2. Mechanical shock due to being dropped may cause damage or a crack in the dielectric material of the capacitor.
 Do not use a dropped capacitor because the quality and reliability may be deteriorated.
3. When printed circuit boards are piled up or handled, the corner of another printed circuit board should not be allowed to hit the capacitor, in order to avoid a crack or other damage to the capacitor.

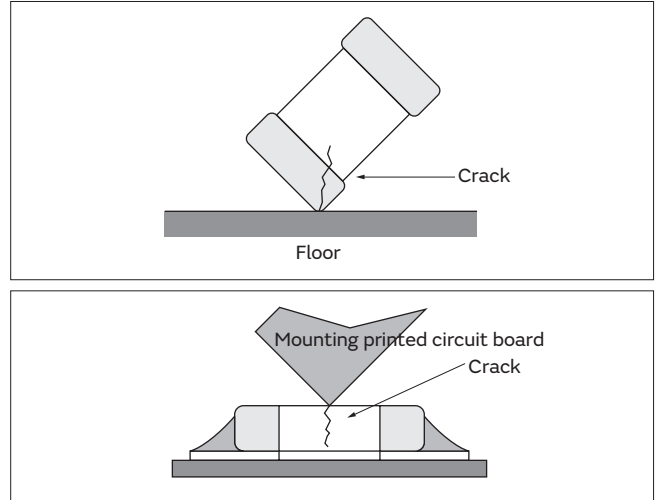

Soldering and Mounting

1. Mounting Position

1. Confirm the best mounting position and direction that minimizes the stress imposed on the capacitor during flexing or bending the printed circuit board.
 - 1-1. Choose a mounting position that minimizes the stress imposed on the chip during flexing or bending of the board.

[Component Direction]

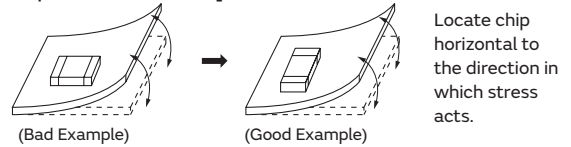

[Chip Mounting Close to Board Separation Point]

It is effective to implement the following measures, to reduce stress in separating the board.
 It is best to implement all of the following three measures; however, implement as many measures as possible to reduce stress.

Contents of Measures	Stress Level
(1) Turn the mounting direction of the component parallel to the board separation surface.	A > D *1
(2) Add slits in the board separation part.	A > B
(3) Keep the mounting position of the component away from the board separation surface.	A > C

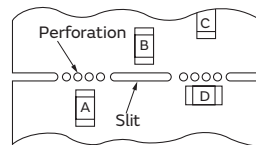

*1 A > D is valid when stress is added vertically to the perforation as with Hand Separation.
 If a Cutting Disc is used, stress will be diagonal to the PCB, therefore A > D is invalid.

[Mounting Capacitors Near Screw Holes]

When a capacitor is mounted near a screw hole, it may be affected by the board deflection that occurs during the tightening of the screw. Mount the capacitor in a position as far away from the screw holes as possible.

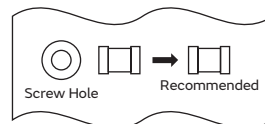

Continued on the following page. ↗

⚠Caution

Continued from the preceding page. ↘

2. Information before Mounting

1. Do not re-use capacitors that were removed from the equipment.
2. Confirm capacitance characteristics under actual applied voltage.
3. Confirm the mechanical stress under actual process and equipment use.
4. Confirm the rated capacitance, rated voltage and other electrical characteristics before assembly.
5. Prior to use, confirm the solderability of capacitors that were in long-term storage.
6. Prior to measuring capacitance, carry out a heat treatment for capacitors that were in long-term storage.
7. The use of Sn-Zn based solder will deteriorate the reliability of the MLCC.
Please contact our sales representative or product engineers on the use of Sn-Zn based solder in advance.
8. We have also produced a DVD which shows a summary of our recommendations, regarding the precautions for mounting. Please contact our sales representative to request the DVD.

3. Maintenance of the Mounting (pick and place) Machine

1. Make sure that the following excessive forces are not applied to the capacitors.
 - 1-1. In mounting the capacitors on the printed circuit board, any bending force against them shall be kept to a minimum to prevent them from any damage or cracking. Please take into account the following precautions and recommendations for use in your process.
 - (1) Adjust the lowest position of the pickup nozzle so as not to bend the printed circuit board.
 - (2) Adjust the nozzle pressure within a static load of 1N to 3N during mounting.
2. Dirt particles and dust accumulated between the suction nozzle and the cylinder inner wall prevent the nozzle from moving smoothly. This imposes greater force upon the chip during mounting, causing cracked chips. Also, the locating claw, when worn out, imposes uneven forces on the chip when positioning, causing cracked chips. The suction nozzle and the locating claw must be maintained, checked, and replaced periodically.

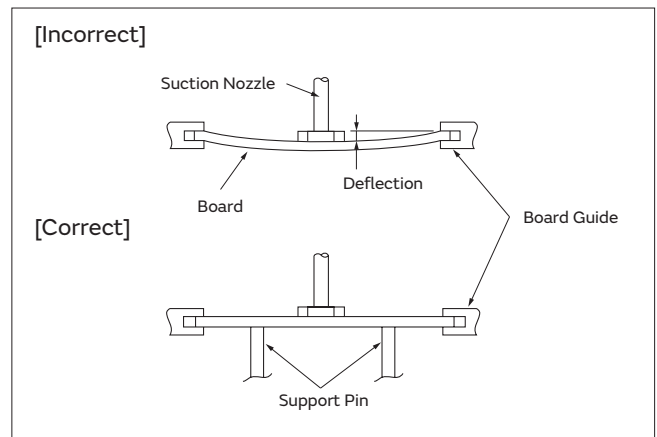

Continued on the following page. ↗



Continued from the preceding page. ↘

4-1. Reflow Soldering

- When sudden heat is applied to the components, the mechanical strength of the components will decrease because a sudden temperature change causes deformation inside the components. In order to prevent mechanical damage to the components, preheating is required for both the components and the PCB. Preheating conditions are shown in table 1. It is required to keep the temperature differential between the solder and the components surface (ΔT) as small as possible.
- When components are immersed in solvent after mounting, be sure to maintain the temperature difference (ΔT) between the component and the solvent within the range shown in table 1.

Table 1

Series	Chip Dimension Code (L/W)	Temperature Differential
GRT/GCM/GC3/GCD/GCE/GCJ	03/15/18/21/31	$\Delta T \leq 190^\circ\text{C}$
GRT/GCM/GCJ	32/43/55	$\Delta T \leq 130^\circ\text{C}$
KCM/KC3/KCA	55	

Recommended Conditions

	Pb-Sn Solder	Lead Free Solder
Peak Temperature	230 to 250°C	240 to 260°C
Atmosphere	Air	Air or N ₂

Pb-Sn Solder: Sn-37Pb

Lead Free Solder: Sn-3.0Ag-0.5Cu

- When a capacitor is mounted at a temperature lower than the peak reflow temperature recommended by the solder manufacturer, the following quality problems can occur. Consider factors such as the placement of peripheral components and the reflow temperature setting to prevent the capacitor's reflow temperature from dropping below the peak temperature specified. Be sure to evaluate the mounting situation beforehand and verify that none of the following problems occur.
 - Drop in solder wettability
 - Solder voids
 - Possible occurrence of whiskering
 - Drop in bonding strength
 - Drop in self-alignment properties
 - Possible occurrence of tombstones and/or shifting on the land patterns of the circuit board

Inverting the PCB

Make sure not to impose any abnormal mechanical shocks to the PCB.

[Standard Conditions for Reflow Soldering]

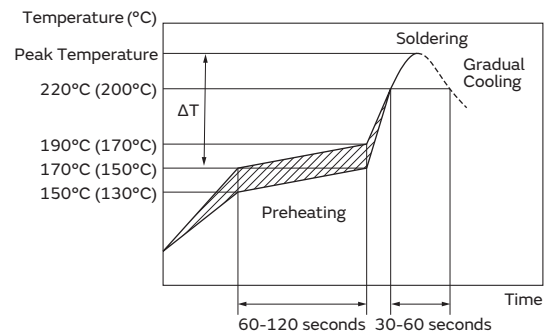

Temperature
 Incase of Lead Free Solder
 (): In case of Pb-Sn Solder

[Allowable Reflow Soldering Temperature and Time]

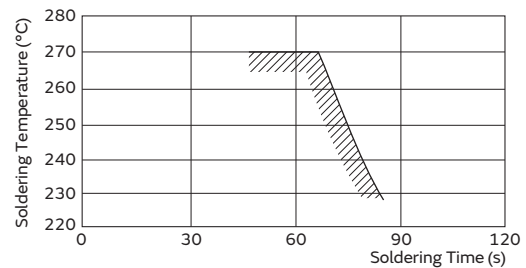

In the case of repeated soldering, the accumulated soldering time must be within the range shown above.

4. Optimum Solder Amount for Reflow Soldering

- 4-1. Overly thick application of solder paste results in an excessive solder fillet height. This makes the chip more susceptible to mechanical and thermal stress on the board and may cause the chips to crack.
- 4-2. Too little solder paste results in a lack of adhesive strength on the termination, which may result in chips breaking loose from the PCB.
- 4-3. Please confirm that solder has been applied smoothly to the termination.

Continued on the following page. ↗

GRT Series

GCM Series

GC3 Series

GCD Series

GCE Series

GCG Series

GCJ Series

KCM Series

KC3 Series

KCA Series

NMF Series

⚠Caution

GRT Series
 GCM Series
 GC3 Series
 GCD Series
 GCE Series
 GCG Series
 GCJ Series
 KCM Series
 KC3 Series
 KCA Series
 NMF Series
 ⚠Caution

⚠Caution

Continued from the preceding page. ↘

4-2. Flow Soldering

1. Do not apply flow soldering to chips not listed in table 2.

Table 2

Series	Chip Dimension Code (L/W)	Temperature Differential
GRT/GCM/GC3/GCD (Except for characteristics of X8L(L8), X8G(5G), CHA(0C), X8R(R9))	18/21/31	$\Delta T \leq 150^\circ\text{C}$
GCJ (Rated Voltage 250VDC or more)		

- When sudden heat is applied to the components, the mechanical strength of the components will decrease because a sudden temperature change causes deformation inside the components. In order to prevent mechanical damage to the components, preheating is required for both of the components and the PCB. Preheating conditions are shown in table 2. It is required to keep the temperature differential between the solder and the components surface (ΔT) as low as possible.
- Excessively long soldering time or high soldering temperature can result in leaching of the terminations, causing poor adhesion or a reduction in capacitance value due to loss of contact between the inner electrodes and terminations.
- When components are immersed in solvent after mounting, be sure to maintain the temperature differential (ΔT) between the component and solvent within the range shown in the table 2.

Recommended Conditions

	Pb-Sn Solder	Lead Free Solder
Preheating Peak Temperature	90 to 110°C	100 to 120°C
Soldering Peak Temperature	240 to 250°C	250 to 260°C
Atmosphere	Air	Air or N ₂

Pb-Sn Solder: Sn-37Pb
 Lead Free Solder: Sn-3.0Ag-0.5Cu

5. Optimum Solder Amount for Flow Soldering

5-1. The top of the solder fillet should be lower than the thickness of the components. If the solder amount is excessive, the risk of cracking is higher during board bending or any other stressful condition.

[Standard Conditions for Flow Soldering]

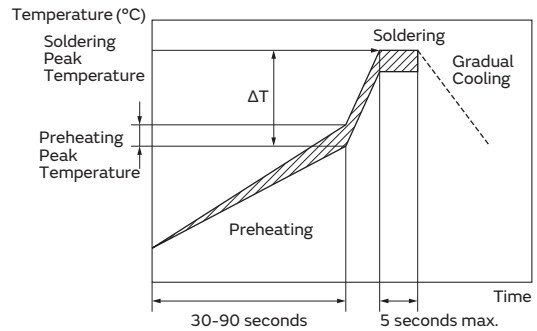

[Allowable Flow Soldering Temperature and Time]

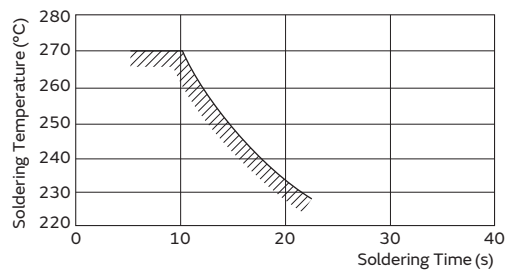

In the case of repeated soldering, the accumulated soldering time must be within the range shown above.

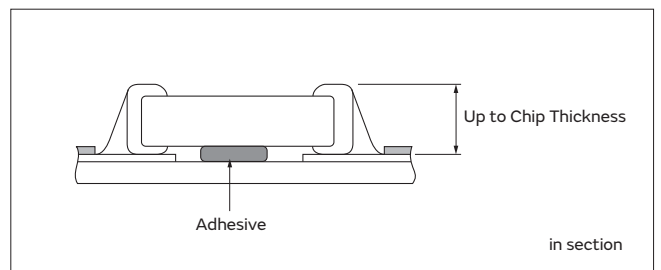

Continued on the following page. ↗

⚠Caution

Continued from the preceding page. ↘

4-3. Correction of Soldered Portion

When sudden heat is applied to the capacitor, distortion caused by the large temperature difference occurs internally, and can be the cause of cracks. Capacitors also tend to be affected by mechanical and thermal stress depending on the board preheating temperature or the soldering fillet shape, and can be the cause of cracks. Please refer to "1. PCB Design" or "3. Optimum solder amount" for the solder amount and the fillet shapes.

1. Correction with a Soldering Iron

- 1-1. In order to reduce damage to the capacitor, be sure to preheat the capacitor and the mounting board. Preheat to the temperature range shown in Table 3. A hot plate, hot air type preheater, etc. can be used for preheating.

Table 3

Series	Chip Dimension Code (L/W)	Temperature of Soldering Iron Tip	Preheating Temperature	Temperature Differential (ΔT)	Atmosphere
GRT/GCM/GC3/GCD/GCE/GCJ	03/15/18/21/31	350°C max.	150°C min.	$\Delta T \leq 190^\circ\text{C}$	Air
GRT/GCM/GCJ	32/43/55	280°C max.	150°C min.	$\Delta T \leq 130^\circ\text{C}$	Air

*Applicable for both Pb-Sn and Lead Free Solder.
 Pb-Sn Solder: Sn-37Pb
 Lead Free Solder: Sn-3.0Ag-0.5Cu
 *Please manage ΔT in the temperature of soldering iron and the preheating temperature.

2. Correction with Spot Heater

Compared to local heating with a soldering iron, hot air heating by a spot heater heats the overall component and board, therefore, it tends to lessen the thermal shock. In the case of a high density mounted board, a spot heater can also prevent concerns of the soldering iron making direct contact with the component.

- 2-1. If the distance from the hot air outlet of the spot heater to the component is too close, cracks may occur due to thermal shock. To prevent this problem, follow the conditions shown in Table 4.

Table 4

Distance	5mm or more
Hot Air Application Angle	45° *Figure 1
Hot Air Temperature Nozzle Outlet	400°C max.
Application Time	Less than 10 seconds (1206 (3216 in mm) size or smaller)
	Less than 30 seconds (1210 (3225 in mm) size or larger)

- 2-2. In order to create an appropriate solder fillet shape, it is recommended that hot air be applied at the angle shown in Figure 1.

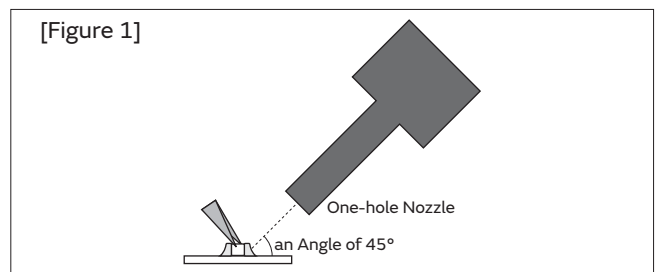

3. Optimum solder amount when re-working with a soldering iron

- 3-1. If the solder amount is excessive, the risk of cracking is higher during board bending or any other stressful condition. Too little solder amount results in a lack of adhesive strength on the outer electrode termination, which may result in chips breaking loose from the PCB. Please confirm that solder has been applied smoothly is and rising to the end surface of the chip.

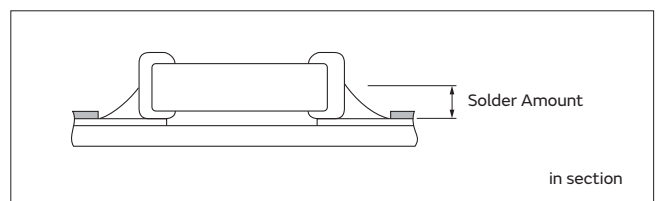

Continued on the following page. ↗

GRT Series
 GCM Series
 GC3 Series
 GCD Series
 GCE Series
 GCG Series
 GCJ Series
 KCM Series
 KC3 Series
 KCA Series
 NMF Series
 ⚠Caution

⚠Caution

Continued from the preceding page. ↘

- 3-2. A soldering iron with a tip of $\varnothing 3\text{mm}$ or smaller should be used. It is also necessary to keep the soldering iron from touching the components during the re-work.
- 3-3. Solder wire with $\varnothing 0.5\text{mm}$ or smaller is required for soldering.

<Applicable to KCM/KC3/KCA Series>

4. For the shape of the soldering iron tip, refer to the figure on the right.

Regarding the type of solder, use a wire diameter of $\varnothing 0.5\text{mm}$ or less (rosin core wire solder).

4-1. How to Apply the Soldering Iron

Apply the tip of the soldering iron against the lower end of the metal terminal.

- 1) In order to prevent cracking caused by sudden heating of the ceramic device, do not touch the ceramic base directly.
- 2) In order to prevent deviations and dislocating of the chip, do not touch the junction of the chip and the metal terminal, and the metal portion on the outside directly.

4-2. Appropriate Amount of Solder

The amount of solder for corrections by soldering iron, should be lower than the height of the lower side of the chip.

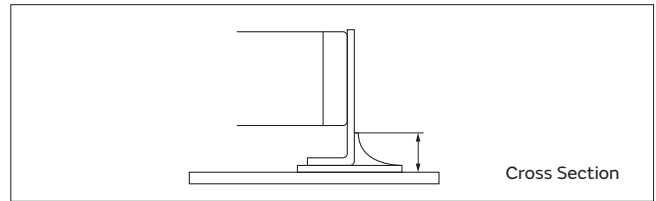
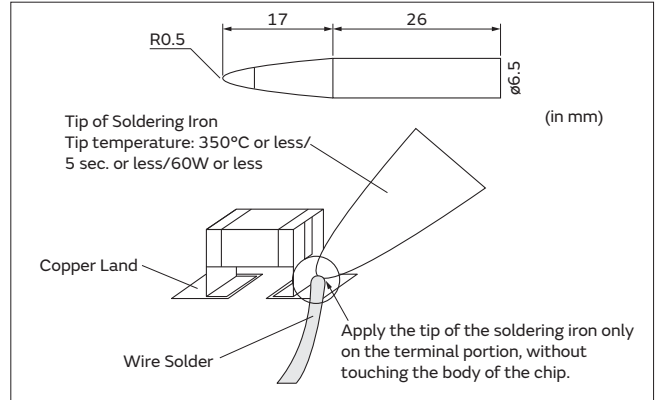

5. Washing

Excessive ultrasonic oscillation during cleaning can cause the PCBs to resonate, resulting in cracked chips or broken solder joints. Take note not to vibrate PCBs.

6. Electrical Test on Printed Circuit Board

1. Confirm position of the support pin or specific jig, when inspecting the electrical performance of a capacitor after mounting on the printed circuit board.

1-1. Avoid bending the printed circuit board by the pressure of a test-probe, etc.

The thrusting force of the test probe can flex the PCB, resulting in cracked chips or open solder joints. Provide support pins on the back side of the PCB to prevent warping or flexing. Install support pins as close to the test-probe as possible.

1-2. Avoid vibration of the board by shock when a test-probe contacts a printed circuit board.

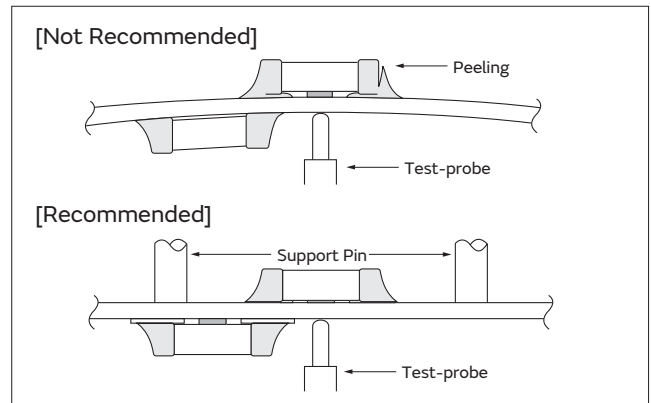

7. Printed Circuit Board Cropping

1. After mounting a capacitor on a printed circuit board, do not apply any stress to the capacitor that causes bending or twisting the board.

1-1. In cropping the board, the stress as shown at right may cause the capacitor to crack.

Avoid this type of stress to a capacitor.

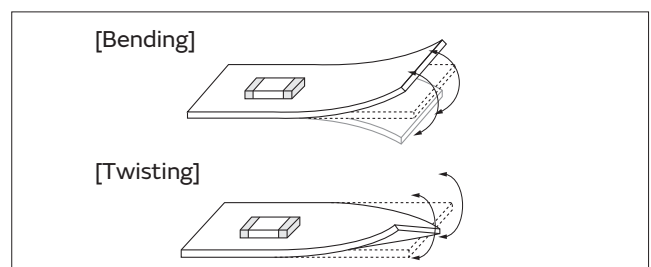

Continued on the following page. ↗



Continued from the preceding page. ↘

2. Check the cropping method for the printed circuit board in advance.

2-1. Printed circuit board cropping shall be carried out by using a jig or an apparatus (Disc separator, router type separator, etc.) to prevent the mechanical stress that can occur to the board.

Board Separation Method	Hand Separation Nipper Separation	(1) Board Separation Jig	Board Separation Apparatus	
			(2) Disc Separator	(3) Router Type Separator
Level of stress on board	High	Medium	Medium	Low
Recommended	×	△*	△*	○
Notes	Hand and nipper separation apply a high level of stress. Use another method.	<ul style="list-style-type: none"> Board handling Board bending direction Layout of capacitors 	<ul style="list-style-type: none"> Board handling Layout of slits Design of V groove Arrangement of blades Controlling blade life 	Board handling

* When a board separation jig or disc separator is used, if the following precautions are not observed, a large board deflection stress will occur and the capacitors may crack. Use router type separator if at all possible.

(1) Example of a suitable jig

[In the case of Single-side Mounting]

An outline of the board separation jig is shown as follows. Recommended example: Stress on the component mounting position can be minimized by holding the portion close to the jig, and bend in the direction towards the side where the capacitors are mounted. Not recommended example: The risk of cracks occurring in the capacitors increases due to large stress being applied to the component mounting position, if the portion away from the jig is held and bent in the direction opposite the side where the capacitors are mounted.

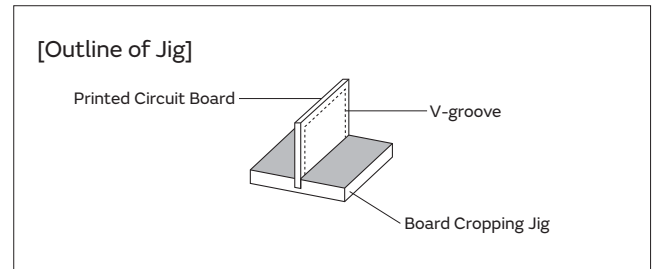

Hand Separation

Recommended	Not Recommended

[In the case of Double-sided Mounting]

Since components are mounted on both sides of the board, the risk of cracks occurring can not be avoided with the above method. Therefore, implement the following measures to prevent stress from being applied to the components.

(Measures)

- (1) Consider introducing a router type separator. If it is difficult to introduce a router type separator, implement the following measures. (Refer to item 1. Mounting Position)
- (2) Mount the components parallel to the board separation surface.
- (3) When mounting components near the board separation point, add slits in the separation position near the component.
- (4) Keep the mounting position of the components away from the board separation point.

Continued on the following page. ↗

GRT Series
 GCM Series
 GC3 Series
 GCD Series
 GCE Series
 GCG Series
 GCJ Series
 KCM Series
 KC3 Series
 KCA Series
 NMF Series
 ⚠Caution

⚠Caution

Continued from the preceding page. ↘

(2) Example of a Disc Separator

An outline of a disc separator is shown as follows. As shown in the Principle of Operation, the top blade and bottom blade are aligned with the V-grooves on the printed circuit board to separate the board.

In the following case, board deflection stress will be applied and cause cracks in the capacitors.

- (1) When the adjustment of the top and bottom blades are misaligned, such as deviating in the top-bottom, left-right or front-rear directions
- (2) The angle of the V groove is too low, depth of the V groove is too shallow, or the V groove is misaligned top-bottom

IF V groove is too deep, it is possible to brake when you handle and carry it. Carefully design depth of the V groove with consideration about strength of material of the printed circuit board.

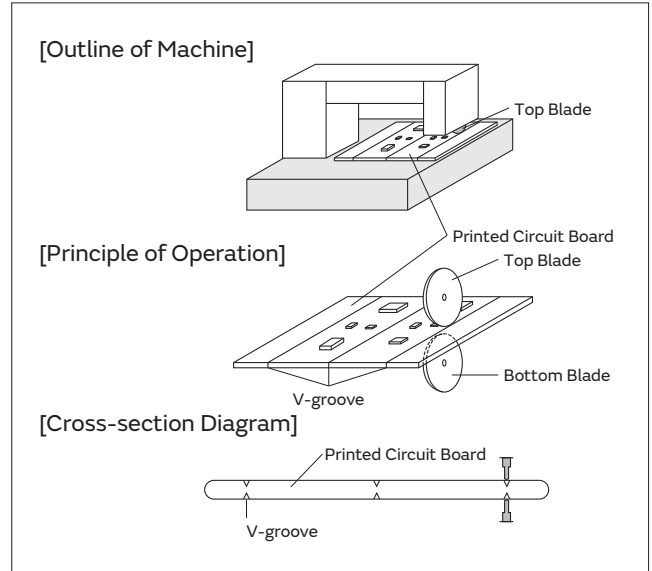

Disc Separator

Recommended	Not Recommended		
	Top-bottom Misalignment	Left-right Misalignment	Front-rear Misalignment
<p>Top Blade</p> <p>Bottom Blade</p>	<p>Top Blade</p> <p>Bottom Blade</p>	<p>Top Blade</p> <p>Bottom Blade</p>	<p>Top Blade</p> <p>Bottom Blade</p>

V-groove Design

Example of Recommended V-groove Design	Not Recommended			
	Left-right Misalignment	Low-Angle	Depth too Shallow	Depth too Deep

(3) Example of Router Type Separator

The router type separator performs cutting by a router rotating at a high speed. Since the board does not bend in the cutting process, stress on the board can be suppressed during board separation.

When attaching or removing boards to/from the router type separator, carefully handle the boards to prevent bending.

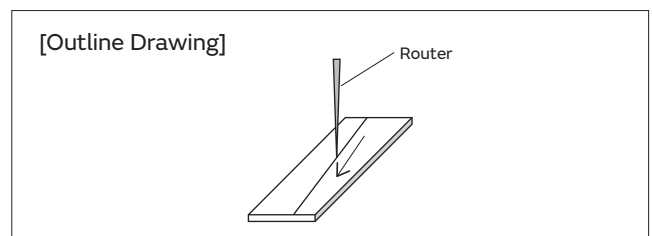

Continued on the following page. ↗

Caution

Continued from the preceding page. ↘

8. Assembly

1. Handling

If a board mounted with capacitors is held with one hand, the board may bend. Firmly hold the edges of the board with both hands when handling.

If a board mounted with capacitors is dropped, cracks may occur in the capacitors.

Do not use dropped boards, as there is a possibility that the quality of the capacitors may be impaired.

2. Attachment of Other Components

2-1. Mounting of Other Components

Pay attention to the following items, when mounting other components on the back side of the board after capacitors have been mounted on the opposite side. When the bottom dead point of the suction nozzle is set too low, board deflection stress may be applied to the capacitors on the back side (bottom side), and cracks may occur in the capacitors.

- After the board is straightened, set the bottom dead point of the nozzle on the upper surface of the board.
- Periodically check and adjust the bottom dead point.

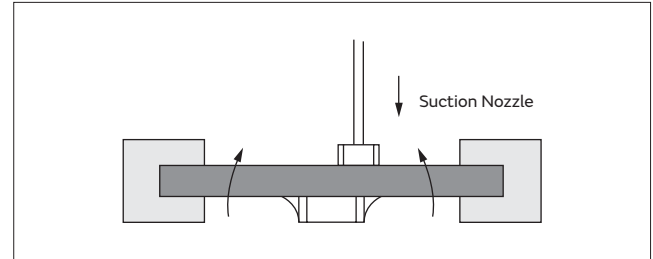

2-2. Inserting Components with Leads into Boards

When inserting components (transformers, IC, etc.) into boards, bending the board may cause cracks in the capacitors or cracks in the solder.

Pay attention to the following.

- Increase the size of the holes to insert the leads, to reduce the stress on the board during insertion.
- Fix the board with support pins or a dedicated jig before insertion.
- Support below the board so that the board does not bend. When using multiple support pins on the board, periodically confirm that there is no difference in the height of each support pin.

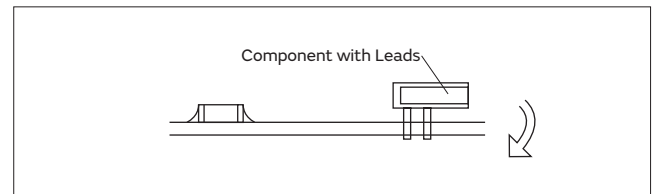

2-3. Attaching/Removing Sockets

When the board itself is a connector, the board may bend when a socket is attached or removed. Plan the work so that the board does not bend when a socket is attached or removed.

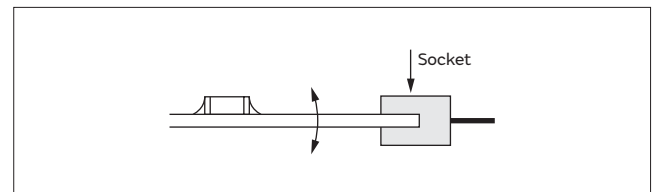

2-4. Tightening Screws

The board may be bent, when tightening screws, etc. during the attachment of the board to a shield or chassis.

Pay attention to the following items before performing the work.

- Plan the work to prevent the board from bending.
- Use a torque screwdriver, to prevent over-tightening of the screws.
- The board may bend after mounting by reflow soldering, etc. Please note, as stress may be applied to the chips by forcibly flattening the board when tightening the screws.

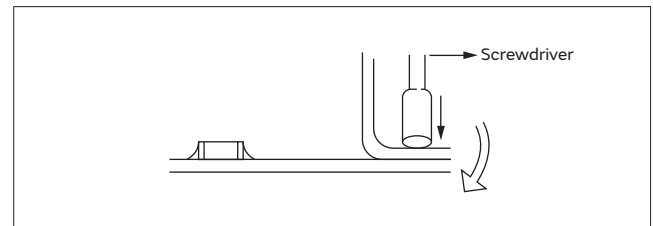

Continued on the following page. ↗

GRT Series

GCM Series

GC3 Series

GCD Series

GCE Series

GCG Series

GCJ Series

KCM Series

KC3 Series

KCA Series

NMF Series

Caution

⚠Caution

Continued from the preceding page. ↘

<Applicable to GCG Series>

9. Selection of Conductive Adhesive, Mounting Process, and Bonding Strength

The acquired bonding strength may change greatly depending on the conductive adhesive to be used.

Be sure to confirm if the desired performance can be acquired in the assumed mounting process with the conductive adhesive to be used.

10. Moisture Proof Process

In order to prevent the occurrence of migration, perform a moisture proof process, such as applying a resin coating or enclosing with a dry inert gas.

11. Application

This product is limited to conductive glue mounting. When performing solder mounting, contact Murata in advance.

Other

1. Under Operation of Equipment

- 1-1. Do not touch a capacitor directly with bare hands during operation in order to avoid the danger of an electric shock.
- 1-2. Do not allow the terminals of a capacitor to come in contact with any conductive objects (short-circuit). Do not expose a capacitor to a conductive liquid, including any acid or alkali solutions.
- 1-3. Confirm the environment in which the equipment will operate is under the specified conditions. Do not use the equipment under the following environments.
 - (1) Being splattered with water or oil.
 - (2) Being exposed to direct sunlight.
 - (3) Being exposed to ozone, ultraviolet rays, or radiation.
 - (4) Being exposed to toxic gas (e.g., hydrogen sulfide, sulfur dioxide, chlorine, ammonia gas, etc.)
 - (5) Any vibrations or mechanical shocks exceeding the specified limits.
 - (6) Moisture condensing environments.
- 1-4. Use damp proof countermeasures if using under any conditions that can cause condensation.

2. Other

- 2-1. In an Emergency
 - (1) If the equipment should generate smoke, fire, or smell, immediately turn off or unplug the equipment. If the equipment is not turned off or unplugged, the hazards may be worsened by supplying continuous power.
 - (2) In this type of situation, do not allow face and hands to come in contact with the capacitor or burns may be caused by the capacitor's high temperature.

2-2. Disposal of Waste

When capacitors are disposed of, they must be burned or buried by an industrial waste vendor with the appropriate licenses.

2-3. Circuit Design

- (1) Addition of Fail Safe Function
Capacitors that are cracked by dropping or bending of the board may cause deterioration of the insulation resistance, and result in a short. If the circuit being used may cause an electrical shock, smoke or fire when a capacitor is shorted, be sure to install fail-safe functions, such as a fuse, to prevent secondary accidents.
- (2) Capacitors used to prevent electromagnetic interference in the primary AC side circuit, or as a connection/insulation, must be a safety standard certified product, or satisfy the contents stipulated in the Electrical Appliance and Material Safety Law. Install a fuse for each line in case of a short.
- (3) The GC3, GCD, GCE, GCG, GCJ, GCM, KC3, and KCM series are not safety standard certified products.

2-4. Remarks

Failure to follow the cautions may result, worst case, in a short circuit and smoking when the product is used.

The above notices are for standard applications and conditions. Contact us when the products are used in special mounting conditions.

Select optimum conditions for operation as they determine the reliability of the product after assembly.

The data herein are given in typical values, not guaranteed ratings.

Notice

Rating

1. Operating Temperature

1. The operating temperature limit depends on the capacitor.

1-1. Do not apply temperatures exceeding the upper operating temperature.

It is necessary to select a capacitor with a suitable rated temperature that will cover the operating temperature range.

It is also necessary to consider the temperature distribution in equipment and the seasonal temperature variable factor.

1-2. Consider the self-heating factor of the capacitor.

The surface temperature of the capacitor shall not exceed the maximum operating temperature including self-heating.

2. Atmosphere Surroundings (gaseous and liquid)

1. Restriction on the operating environment of capacitors.

1-1. Capacitors, when used in the above, unsuitable,

operating environments may deteriorate due to the corrosion of the terminations and the penetration of moisture into the capacitor.

1-2. The same phenomenon as the above may occur when the electrodes or terminals of the capacitor are subject to moisture condensation.

1-3. The deterioration of characteristics and insulation resistance due to the oxidization or corrosion of terminal electrodes may result in breakdown when the capacitor is exposed to corrosive or volatile gases or solvents for long periods of time.

3. Piezo-electric Phenomenon

1. When using high dielectric constant type capacitors in AC or pulse circuits, the capacitor itself vibrates at specific frequencies and noise may be generated.

Moreover, when the mechanical vibration or shock is added to the capacitor, noise may occur.

Soldering and Mounting

1. PCB Design

1. Notice for Pattern Forms

1-1. Unlike leaded components, chip components are susceptible to flexing stresses since they are mounted directly on the substrate. They are also more sensitive to mechanical and thermal stresses than leaded components. Excess solder fillet height can multiply these stresses and cause chip cracking. When designing substrates, take land patterns and dimensions into consideration to eliminate the possibility of excess solder fillet height.

1-2. There is a possibility of chip cracking caused by PCB expansion/contraction with heat, because stress on a chip is different depending on PCB material and structure. When the thermal expansion coefficient greatly differs between the board used for mounting and the chip, it will cause cracking of the chip due to the thermal expansion and contraction. When capacitors are mounted on a fluorine resin printed circuit board or on a single-layered glass epoxy board, it may also cause cracking of the chip for the same reason.

Pattern Forms

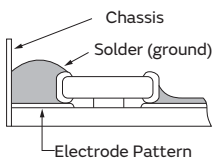
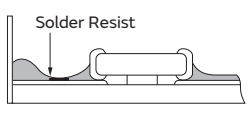
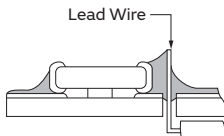
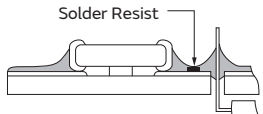
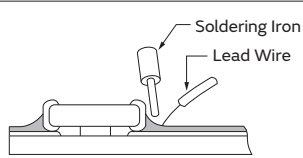
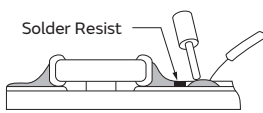
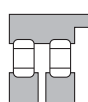
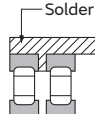
	Prohibited	Correct
Placing Close to Chassis		
Placing of Chip Components and Leaded Components		
Placing of Leaded Components after Chip Component		
Lateral Mounting		

Continued on the following page. ↗

GRT Series
 GCM Series
 GC3 Series
 GCD Series
 GCE Series
 GCG Series
 GCJ Series
 KCM Series
 KC3 Series
 KCA Series
 NMF Series
 Notice

Notice

Continued from the preceding page. ↘

2. Land Dimensions

2-1. Chip capacitors can be cracked due to the stress of PCB bending, etc. if the land area is larger than needed and has an excess amount of solder. Please refer to the land dimensions in table 1 for flow soldering, table 2 for reflow soldering. Please confirm the suitable land dimension by evaluating of the actual SET / PCB.

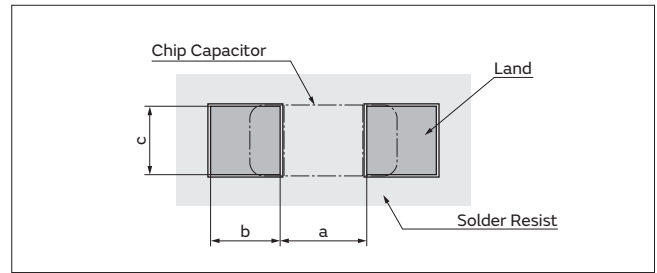

Table 1 Flow Soldering Method

Series	Chip Dimension Code (L/W)	Chip (L×W)	a	b	c
GRT/GCM/GC3/GCD/GCJ (Rated Voltage: above 250VDC (for GCJ alone))	18	1.6×0.8	0.6 to 1.0	0.8 to 0.9	0.6 to 0.8
	21	2.0×1.25	1.0 to 1.2	0.9 to 1.0	0.8 to 1.1
	31	3.2×1.6	2.2 to 2.6	1.0 to 1.1	1.0 to 1.4

Flow soldering can only be used for products with a chip size from 1.6x0.8mm to 3.2x1.6mm.

(in mm)

Table 2 Reflow Soldering Method

Series	Chip Dimension Code (L/W)	Chip (L×W)	a	b	c
GRT/GCM/GC3/ GCD/GCE/GCJ	03	0.6×0.3	0.2 to 0.3	0.2 to 0.35	0.2 to 0.4
	15	1.0×0.5	0.3 to 0.5	0.35 to 0.45	0.4 to 0.6
	18	1.6×0.8	0.6 to 0.8	0.6 to 0.7	0.6 to 0.8
	21	2.0×1.25	1.0 to 1.2	0.6 to 0.7	0.8 to 1.1
	31	3.2×1.6	2.2 to 2.4	0.8 to 0.9	1.0 to 1.4
	32	3.2×2.5	2.0 to 2.4	1.0 to 1.2	1.8 to 2.3
	43	4.5×3.2	3.0 to 3.5	1.2 to 1.4	2.3 to 3.0
	55	5.7×5.0	4.0 to 4.6	1.4 to 1.6	3.5 to 4.8

(in mm)

<Applicable to Part Number KCM/KC3/KCA>

Series	Chip Dimension Code (L/W)	Chip (L×W)	a	b	c
KCM/KC3	55	5.7×5.0	2.6	2.7	5.6
KCA	55	5.7×5.0	3.2	2.7	5.6

(in mm)

<Applicable to beyond Rated Voltage of 200VDC>

2-2. Dimensions of Slit (Example)

Preparing the slit helps flux cleaning and resin coating on the back of the capacitor. However, the length of the slit design should be as short as possible to prevent mechanical damage in the capacitor.

A longer slit design might receive more severe mechanical stress from the PCB. Recommended slit design is shown in the Table.

L×W	d	e
1.6×0.8	-	-
2.0×1.25	-	-
3.2×1.6	1.0 to 2.0	3.2 to 3.7
3.2×2.5	1.0 to 2.0	4.1 to 4.6
4.5×2.0	1.0 to 2.8	3.6 to 4.1
4.5×3.2	1.0 to 2.8	4.8 to 5.3
5.7×2.8	1.0 to 4.0	4.4 to 4.9
5.7×5.0	1.0 to 4.0	6.6 to 7.1

(in mm)

Continued on the following page. ↗

Notice

Continued from the preceding page. ↘

3. Board Design

When designing the board, keep in mind that the amount of strain which occurs will increase depending on the size and material of the board.

[Relationship with amount of strain to the board thickness, length, width, etc.]

$$\epsilon = \frac{3PL}{2Ewh^2}$$

Relationship between load and strain

- ε: Strain on center of board (μst)
- L: Distance between supporting points (mm)
- w: Board width (mm)
- h: Board thickness (mm)
- E: Elastic modulus of board (N/m²=Pa)
- Y: Deflection (mm)
- P: Load (N)

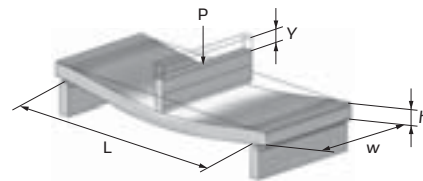

When the load is constant, the following relationship can be established.

- As the distance between the supporting points (L) increases, the amount of strain also increases.
→Reduce the distance between the supporting points.
 - As the elastic modulus (E) decreases, the amount of strain increases.
→Increase the elastic modulus.
 - As the board width (w) decreases, the amount of strain increases.
→Increase the width of the board.
 - As the board thickness (h) decreases, the amount of strain increases.
→Increase the thickness of the board.
- Since the board thickness is squared, the effect on the amount of strain becomes even greater.

2. Adhesive Application

1. Thin or insufficient adhesive can cause the chips to loosen or become disconnected during flow soldering.

The amount of adhesive must be more than dimension c, shown in the drawing at right, to obtain the correct bonding strength.

The chip's electrode thickness and land thickness must also be taken into consideration.

2. Low viscosity adhesive can cause chips to slip after mounting. The adhesive must have a viscosity of 5000Pa · s (500ps) min. (at 25°C).

3. Adhesive Coverage

Size (L×W) (in mm)	Adhesive Coverage*
1.6×0.8	0.05mg min.
2.0×1.25	0.1mg min.
3.2×1.6	0.15mg min.

*Nominal Value

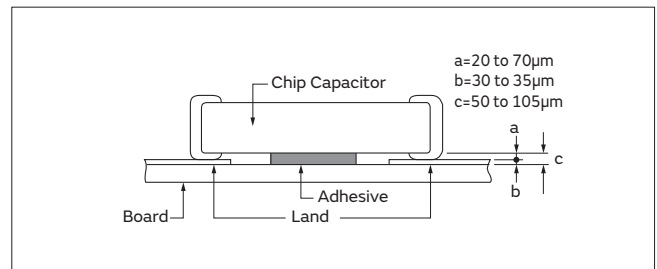

3. Adhesive Curing

1. Insufficient curing of the adhesive can cause chips to disconnect during flow soldering and causes deterioration in the insulation resistance between the terminations due to moisture absorption.

Control curing temperature and time in order to prevent insufficient hardening.

Continued on the following page. ↗

GRT Series

GCM Series

GC3 Series

GCD Series

GCE Series

GCG Series

GCJ Series

KCM Series

KC3 Series

KCA Series

NMF Series

Notice

Notice

Continued from the preceding page. ↘

4. Flux for Flow Soldering

1. An excessive amount of flux generates a large quantity of flux gas, which can cause a deterioration of solderability, so apply flux thinly and evenly throughout. (A foaming system is generally used for flow soldering.)
2. Flux containing too high a percentage of halide may cause corrosion of the terminations unless there is sufficient cleaning. Use flux with a halide content of 0.1% max.
3. Do not use strong acidic flux.

5. Flow Soldering

- Set temperature and time to ensure that leaching of the termination does not exceed 25% of the chip end area as a single chip (full length of the edge A-B-C-D shown at right) and 25% of the length A-B shown as mounted on substrate.

6. Reflow Soldering

The halogen system substance and organic acid are included in solder paste, and a chip corrodes by this kind of solder paste.

7. Washing

1. Please evaluate the capacitor using actual cleaning equipment and conditions to confirm the quality, and select the solvent for cleaning.
2. Unsuitable cleaning solvent may leave residual flux or other foreign substances, causing deterioration of electrical characteristics and the reliability of the capacitors.

8. Coating

1. A crack may be caused in the capacitor due to the stress of the thermal contraction of the resin during curing process.
The stress is affected by the amount of resin and curing contraction.
Select a resin with low curing contraction.
The difference in the thermal expansion coefficient between a coating resin or a molding resin and the capacitor may cause the destruction and deterioration of the capacitor such as a crack or peeling, and lead to the deterioration of insulation resistance or dielectric breakdown.

4. Do not use water-soluble flux.*

(*Water-soluble flux can be defined as non-rosin type flux including wash-type flux and non-wash-type flux.)

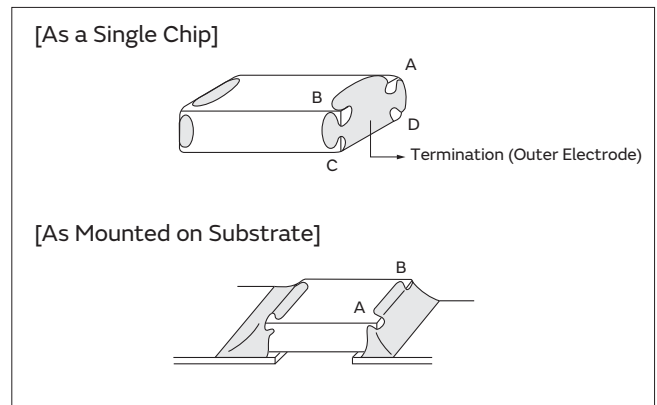

Do not use strong acid flux.

Do not use water-soluble flux*.

(*Water-soluble flux can be defined as non-rosin type flux including wash-type flux and non-wash-type flux.)

3. Select the proper cleaning conditions.

3-1. Improper cleaning conditions (excessive or insufficient) may result in deterioration of the performance of the capacitors.

Select a resin for which the thermal expansion coefficient is as close to that of the capacitor as possible.

A silicone resin can be used as an under-coating to buffer against the stress.

2. Select a resin that is less hygroscopic.

Using hygroscopic resins under high humidity conditions may cause the deterioration of the insulation resistance of a capacitor.

An epoxy resin can be used as a less hygroscopic resin.

3. The halogen system substance and organic acid are included in coating material, and a chip corrodes by the kind of Coating material.

Do not use strong acid type.

Continued on the following page. ↗

Notice

Continued from the preceding page. ↘

Other

1. Transportation

1. The performance of a capacitor may be affected by the conditions during transportation.
 - 1-1. The capacitors shall be protected against excessive temperature, humidity, and mechanical force during transportation.
 - (1) Climatic condition
 - low air temperature: -40°C
 - change of temperature air/air: -25°C/+25°C
 - low air pressure: 30 kPa
 - change of air pressure: 6 kPa/min.
 - (2) Mechanical condition

Transportation shall be done in such a way that the boxes are not deformed and forces are not directly passed on to the inner packaging.
 - 1-2. Do not apply excessive vibration, shock, or pressure to the capacitor.
 - (1) When excessive mechanical shock or pressure is applied to a capacitor, chipping or cracking may occur in the ceramic body of the capacitor.
 - (2) When the sharp edge of an air driver, a soldering iron, tweezers, a chassis, etc. impacts strongly on the surface of the capacitor, the capacitor may crack and short-circuit.
 - 1-3. Do not use a capacitor to which excessive shock was applied by dropping, etc.

A capacitor dropped accidentally during processing may be damaged.

2. Characteristics Evaluation in the Actual System

1. Evaluate the capacitor in the actual system, to confirm that there is no problem with the performance and specification values in a finished product before using.
2. Since a voltage dependency and temperature dependency exists in the capacitance of high dielectric type ceramic capacitors, the capacitance may change depending on the operating conditions in the actual system. Therefore, be sure to evaluate the various characteristics, such as the leakage current and noise absorptivity, which will affect the capacitance value of the capacitor.
3. In addition, voltages exceeding the predetermined surge may be applied to the capacitor by the inductance in the actual system. Evaluate the surge resistance in the actual system as required.

GRT Series

GCM Series

GC3 Series

GCD Series

GCE Series

GCG Series

GCJ Series

KCM Series

KC3 Series

KCA Series

NMF Series

Notice

GRT Series

GCM Series

GC3 Series

GCD Series

GCE Series

GCG Series

GCJ Series

KCM Series

KC3 Series

KCA Series

NMF Series

⚠️Caution/Notice/
 Soldering/Mounting

NFM

⚠️Caution/Notice/Soldering and Mounting

⚠️Caution

Rating 85

Soldering and Mounting 85

Notice

Storage and Operating Conditions 86

Notice (Soldering and Mounting) 86

Handling 86

Soldering and Mounting

- 1. Standard Land Pattern Dimensions 87
- 2. Solder Paste Printing and Adhesive Application 88
- 3. Standard Soldering Conditions 88
- 4. Cleaning 89



Rating

1. About the Rated Current

Do not use products beyond the rated current and rated voltage as this may create excessive heat and deteriorate the insulation resistance.

Soldering and Mounting

1. Self-heating

Please provide special attention when mounting chip NFM series in close proximity to other products that radiate heat. The heat generated by other products may deteriorate the insulation resistance and cause excessive heat in this component.

Worst case, results to a short circuit which causes fuming or partial dispersion when the product is used.

2. Be sure to provide an appropriate fail-safe function on your product to prevent a second damage that may be caused by the abnormal function or the failure our product.

GRT Series

GCM Series

GC3 Series

GCD Series

GCE Series

GCG Series

GCJ Series

KCM Series

KC3 Series

KCA Series

NMF Series

⚠Caution

Notice

Storage and Operating Conditions

<Operating Environment>

Do not use products in a chemical atmosphere such as chlorine gas, acid or sulfide gas.

Do not use products in the environment close to the organic solvent.

<Storage and Handling Requirements>

1. Storage Period

The NF series should be used within 12 months.

Products to be used after this period should be checked for solderability or bondability with glue.

2. Storage Conditions

(1) Storage temperature: -10 to +40°C

Relative humidity: 15 to 85%

Avoid sudden changes in temperature and humidity.

(2) Do not store products in a chemical atmosphere such as chlorine gas, acid or sulfide gas.

Notice (Soldering and Mounting)

1. Cleaning

Failure and degradation of a product are caused by the cleaning method. When you clean in conditions that are not in mounting information, please contact Murata engineering.

2. Soldering

Reliability decreases with improper soldering methods.

Please solder by the standard soldering conditions shown in mounting information.

3. Points of Attention about NFM Pattern Forms

The loaded stresses are different to a chip depend on PCB materials and structures.

When the chip will be mounted on the metal PCB contained alumina material, PCB heat expansion/contraction will be a cause of chip cracks because the coefficients of thermal expressions are different between metal PCB and the chip itself.

4. Other

Noise suppression levels resulting from Murata's EMI suppression filters EMIFIL[®] may vary, depending on the circuits and ICs used, type of noise, mounting pattern, mounting location, and other operating conditions. Be sure to check and confirm in advance the noise suppression effect of each filter, in actual circuits, etc. before applying the filter in a commercial-purpose equipment design.

Handling

1. Resin Coating

Using resin for coating/molding products may affect the products performance.

So please pay careful attention in selecting resin.

Prior to use, please make the reliability evaluation with the product mounted in your application set.

2. Handling of a Substrate

After mounting products on a substrate, do not apply any stress to the product caused by bending or twisting to the substrate when cropping the substrate, inserting and removing a connector from the substrate or tightening screw to the substrate.

Excessive mechanical stress may cause cracking in the Product.

Bending

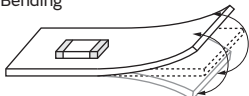

Twisting

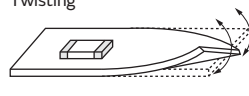

Soldering and Mounting

1. Standard Land Pattern Dimensions

NFM series suppress noise by conducting the high-frequency noise element to ground. Therefore, to obtain maximum performance from these filters, the ground pattern should be made as large as possible during the PCB design stage. As shown below, one side of the PCB is used for chip mounting, and the other is used for grounding.

Small diameter feedthrough holes are then used to connect the grounds on each side of the PCB. This reduces the high-frequency impedance of the grounding and maximizes the filter's performance.

Land Pattern + Solder Resist
 Land Pattern
 Solder Resist (in mm)

<p>NFM21HC</p>	<p>● Reflow Soldering</p> <p>NFM21HC</p> <p>Small diameter thru hole $\phi 0.4$</p> <p>Please contact us if using thinner land pad than 18μm.</p>	
<p>NFM31HK</p>	<p>● Reflow Soldering Chip mounting side</p> <p>NFM31HK*1</p> <p>Small diameter thru hole $\phi 0.4$</p> <p>10mm or more (in case of 10A)</p> <p>*1 For large current design, width of signal land pattern should be wider not less than 1mm per 1A (1mm/A). For example, in case of 10A, signal land pattern width should be 10mm or more. (1mm/A*10A=10mm)</p>	<p>● Flow Soldering Chip mounting side</p> <p>NFM31HK*1</p> <p>Small diameter thru hole $\phi 0.4$</p> <p>10mm or more (in case of 10A)</p> <p>*1 For large current design, width of signal land pattern should be wider not less than 1mm per 1A (1mm/A). For example, in case of 10A, signal land pattern width should be 10mm or more. (1mm/A*10A=10mm)</p>

(1) PCB Warping

PCB should be designed so that products are not subjected to the mechanical stress caused by warping the board.

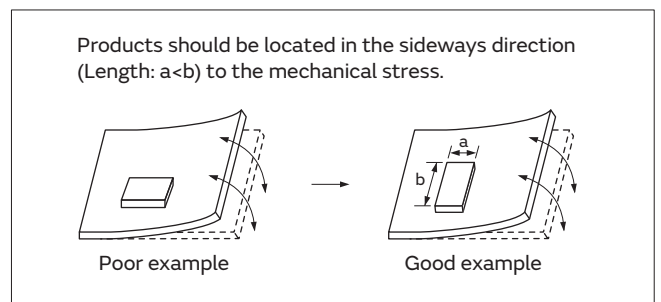

(2) Amount of Solder Paste

Excessive solder causes electrode corrosion, while insufficient solder causes low electrode bonding strength.

Continued on the following page. ↗

Soldering and Mounting

Continued from the preceding page. ↘

2. Solder Paste Printing and Adhesive Application

When reflow soldering NFM series, the printing must be conducted in accordance with the following cream solder printing conditions.

If too much solder is applied, the chip will be prone to damage by mechanical and thermal stress from the PCB and may crack.

Standard land dimensions should be used for resist and copper foil patterns.

When flow soldering NFM series, apply the adhesive in accordance with the following conditions.

If too much adhesive is applied, then it may overflow into the land or termination areas and yield poor solderability.

In contrast, if insufficient adhesive is applied, or if the adhesive is not sufficiently hardened, then the chip may become detached during flow soldering process.

(in mm)

Series	Solder Paste Printing	Adhesive Application
NFM21HC NFM31HK	<p>● Guideline of solder paste thickness: 100-150μm: NFM21HC/31HK</p> <div style="display: flex; justify-content: space-around;"> <div style="text-align: center;"> <p>NFM21HC</p> </div> <div style="text-align: center;"> <p>NFM31HK</p> </div> </div>	<p>■ NFM31HK Series Apply 0.06mg of bonding agent at each chip. Do not cover electrodes.</p> <div style="display: flex; justify-content: space-around;"> </div>

3. Standard Soldering Conditions

(1) Soldering Methods

Use flow and reflow soldering methods only.

Use standard soldering conditions when soldering chip EMI suppression filters.

In cases where several different parts are soldered, each having different soldering conditions, use those conditions requiring the least heat and minimum time.

Solder: Use Sn-3.0Ag-0.5Cu solder. Use of Sn-Zn based solder will deteriorate performance of products.

If using NFM series with Sn-Zn based solder, please contact Murata in advance.

Flux:

● Use Rosin-based flux.

In case of using RA type solder, products should be cleaned completely with no residual flux.

● Do not use strong acidic flux (with chlorine content exceeding 0.20wt%)

● Do not use water-soluble flux.

For additional mounting methods, please contact Murata.

(2) Soldering Profile

● Flow Soldering Profile (Sn-3.0Ag-0.5Cu Solder)

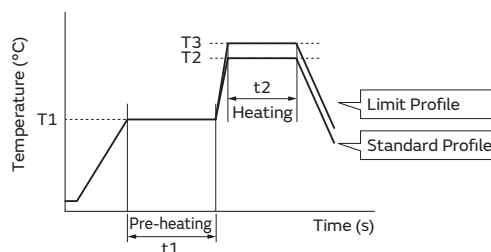

Series	Pre-heating		Standard Profile			Limit Profile		
	Temp. (T1)	Time. (t1)	Heating		Cycle of Flow	Heating		Cycle of Flow
			Temp. (T2)	Time. (t2)		Temp. (T3)	Time. (t2)	
NFM31HK	150°C	60s min.	250°C	4 to 6s	2 times max.	265±3°C	5s max.	2 times max.

Continued on the following page. ↗

Soldering and Mounting

Soldering and Mounting

Continued from the preceding page. ↘

● Reflow Soldering Profile (Sn-3.0Ag-0.5Cu Solder)

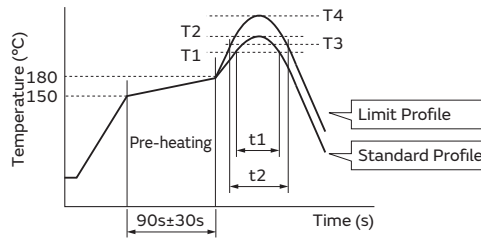

Series	Standard Profile				Limit Profile			
	Heating		Peak Temperature (T2)	Cycle of Reflow	Heating		Peak Temperature (T4)	Cycle of Reflow
	Temp. (T1)	Time. (t1)			Temp. (T3)	Time. (t2)		
NFM21HC NFM31HK	220°C min.	30 to 60s	245±3°C	2 times max.	230°C min.	60s max.	260°C/10s	2 times max.

(3) Reworking with Solder Iron

The following conditions must be strictly followed when using a soldering iron.

Pre-heating: 150°C 60s min.

Soldering iron power output / Tip diameter:

30W max. / ø3mm max.

Temperature of soldering iron tip / Soldering time / Times:

350°C max. / 3-4s / 2 times

Do not allow the tip of the soldering iron to directly contact the chip.

For additional methods of reworking with a soldering iron, please contact Murata engineering.

4. Cleaning

Following conditions should be observed when cleaning chip EMI filter.

(1) Cleaning Temperature: 60°C max. (40°C max. for alcohol type cleaner)

(2) Ultrasonic

Output: 20W/liter max.

Duration: 5 minutes max.

Frequency: 28 to 40kHz

Care should be taken not to cause resonance of the PCB and mounted products.

(3) Cleaning Agent

The following list of cleaning agents have been tested on the individual components. Evaluation of final assembly should be completed prior to production.

(a) Alcohol cleaning agent

Isopropyl alcohol (IPA)

(b) Aqueous cleaning agent

Pine Alpha ST-100S

(4) Ensure that flux residue is completely removed.

Component should be thoroughly dried after aqueous agent has been removed with deionized water.

GRT Series

GCM Series

GC3 Series

GCD Series

GCE Series

GCG Series

GCJ Series

KCM Series

KC3 Series

KCA Series

NMF Series

Soldering and Mounting

Catalog information

Catalog relates to a multilayer ceramic capacitor is below.



Chip Monolithic Ceramic Capacitors
Cat No. C02E-19

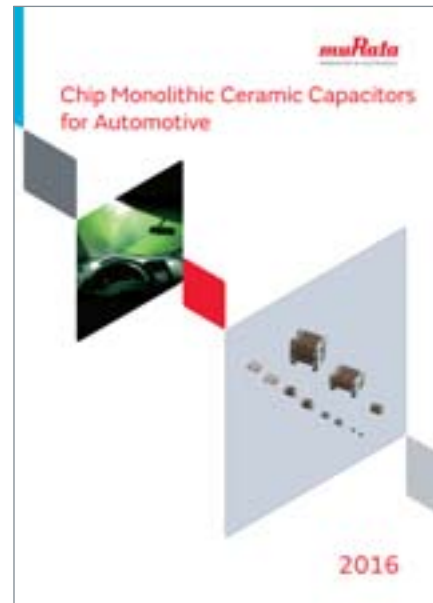

Chip Monolithic Ceramic Capacitors for Automotive
Cat No. C03E-9

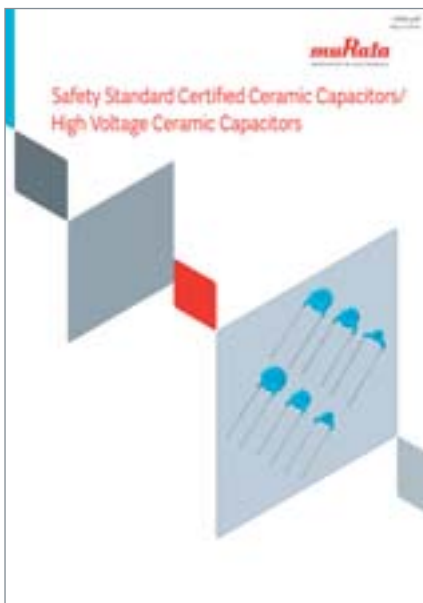

Safety Certified Ceramic Capacitors/ High Voltage Ceramic Capacitors
Cat No. C85E-5

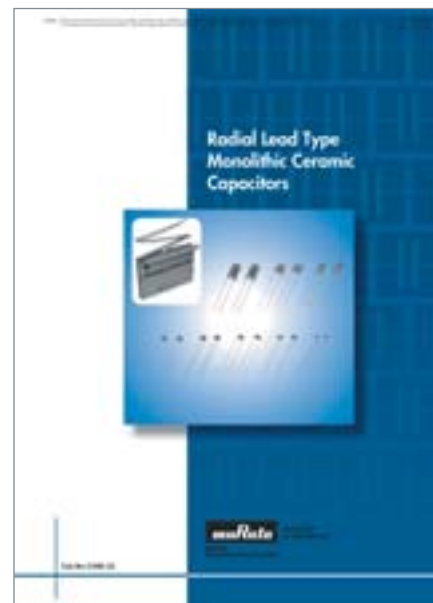

Radial Lead Type Monolithic Ceramic Capacitors
Cat No. C49E-22

Design Support Tool "SimSurfing"

<http://www.murata.com/simsurfing/>

This is the latest tool to get the electrical characteristics for Capacitors, Inductors, and EMI Suppression Filters, and to simulate Thermistors' behavior !



■ Characteristics viewer
 You can easily search and download the following data for Monolithic Ceramic Capacitors, Polymer Capacitors, EMI Suppression Filters (Three-terminal Capacitors, Ferrite Beads) and Power/RF Inductors.

■ Components performance simulator
 You can search by the simulation on simple circuits for Thermistors.

■ Selection tool
 You can select Medium voltage Capacitors and Power Inductors according to conditions of use.
 * Medium voltage: Rated Voltage 250V and over

■ Search tool
 You can search the Murata timing device (CERALOCK® and crystal units) that is most suitable for your IC and access information about the recommended circuit constant setting.

If you register as a "my Murata" user (<https://my.murata.com/en/web/mymurata/>), you can use Enhanced SimSurfing.

■ Usage example of "Monolithic Ceramic Capacitors"

1 Select the products

- (1) By performance/type
- (2) By part number

2 Show graph

Click each button on each tab of [Basic], [S-parameter] and [Detailed].

3 Data download

- Click each purple button in this area.
- Click "CSV output" button.

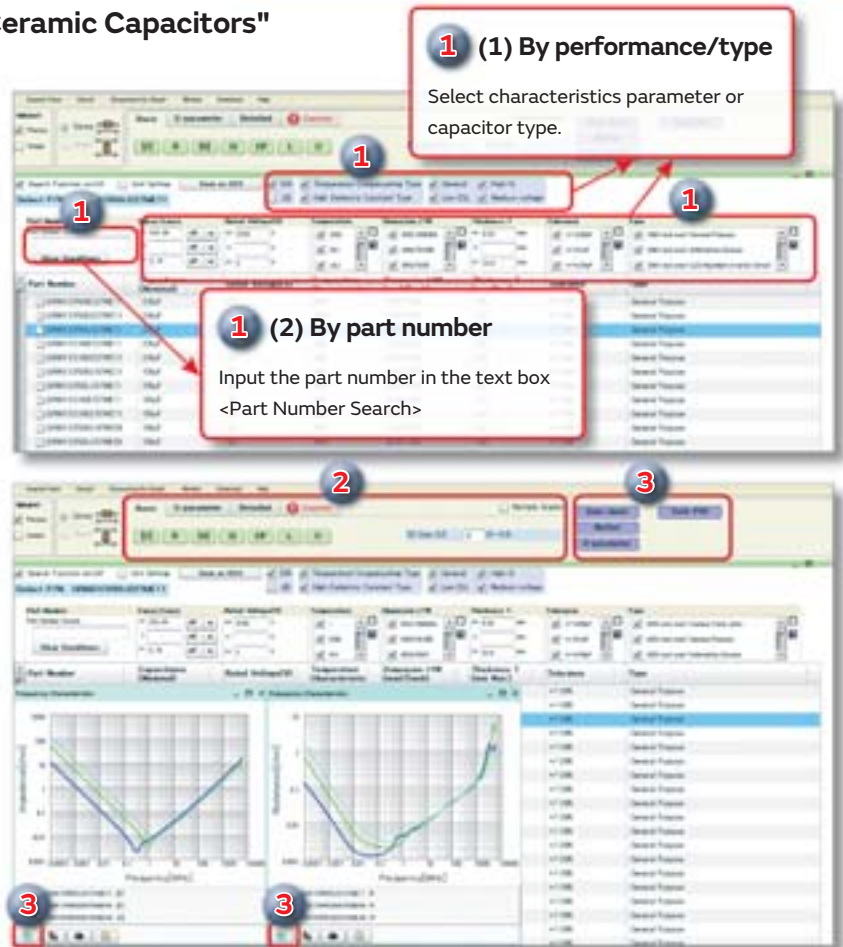

1 (1) By performance/type
 Select characteristics parameter or capacitor type.

1 (2) By part number
 Input the part number in the text box <Part Number Search>

2
 Click each button on each tab of [Basic], [S-parameter] and [Detailed].

3
 Click each purple button in this area. Click "CSV output" button.

* Images are as of October 2015. Be assured that this software will be updated frequently.

<http://www.murata.com/simsurfing/>

Capacitor Website Introduction



Search for Capacitors

Global

Murata capacitors can be searched.

1 Search by part number

2 Search by specifications

3 Search by features

4 Search in the lineups

5 Cross reference

1

Search by part number

<http://psearch.murata.com/capacitor/partnumber/>



The applicable capacitors can be searched by alphanumeric characters. Although the alternative symbol "#" is used for the package specification code, you can also enter the full package specification code to search the part number including the package specification code.

2

Search by specifications

<http://psearch.murata.com/capacitor/spec/>

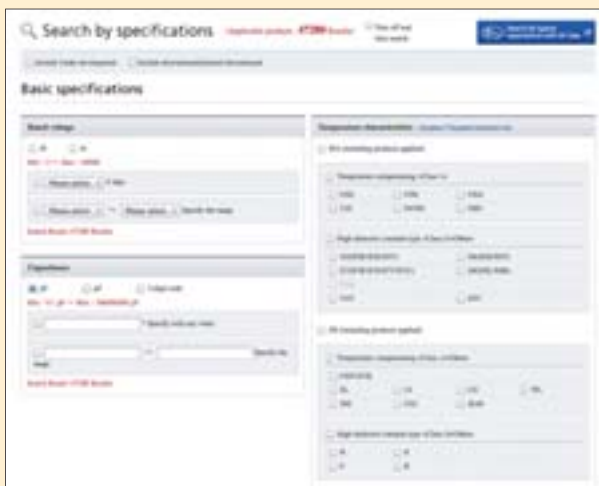

Capacitors can be searched by various specifications, such as the capacitance, rated voltage, and temperature characteristics.

Basic specifications

Applicable products can be searched by any value and specified range.

To support the entry, the minimum and maximum values of the product applicable to the conditions selected in the other items will be displayed.

Add detailed specifications

Setting the conditions particular to the SMD, mold and lead, enables you to search the product with a more detailed specification.

3

Search by features

<http://psearch.murata.com/capacitor/feature/>

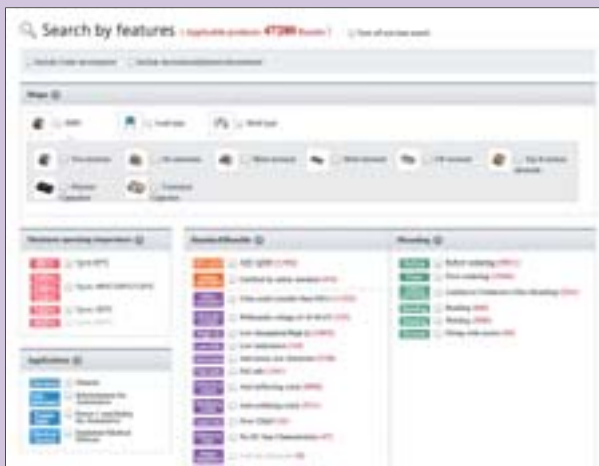

The applicable capacitors can be searched by the Shape, Maximum operating temperature, Applications, Benefits, and Mounting.

Select the conditions of the following items to search for a product.

- "Shape"
- "Maximum operating temperature"
- "Applications"
- "Benefits"
- "Mounting"

4 Search in the lineups <http://psearch.murata.com/capacitor/lineup/>

Capacitors applicable to the conditions can be searched from the lineup of each series.

The features and applications of the series can also be checked in the Series page.

Capacitance chart in Series page



5 Cross reference <http://cross-reference.murata.com/capacitor/crossreference/index.cfm>



The Murata part number applicable to the assumed specification can be searched by the competitor's part number of the chip monolithic ceramic capacitors.

[Search result]



It is possible to characteristic comparison.

Search result of SMD (Applicable products: 43504 results)

- The number of cases applicable to the current search conditions is always displayed in real time.
- Click each search condition button to display the menu. The search results will change in real time with the selected conditions.
- Clicking the "Current search conditions" opens a menu, and the current narrowed down conditions can be checked.
- The results can be sorted by clicking the ▲ button of the search results items.
- Clicking the product name opens the details page, and more detailed information can be acquired.
- Detailed specifications sheet can be downloaded without opening the details page.
- The icons clearly indicate the status and the features of the product.

Global Locations

For details please visit www.murata.com



⚠ Note

1 Export Control

For customers outside Japan:

No Murata products should be used or sold, through any channels, for use in the design, development, production, utilization, maintenance or operation of, or otherwise contribution to (1) any weapons (Weapons of Mass Destruction [nuclear, chemical or biological weapons or missiles] or conventional weapons) or (2) goods or systems specially designed or intended for military end-use or utilization by military end-users.

For customers in Japan:

For products which are controlled items subject to the "Foreign Exchange and Foreign Trade Law" of Japan, the export license specified by the law is required for export.

2 Please contact our sales representatives or product engineers before using the products in this catalog for the applications listed below, which require especially high reliability for the prevention of defects which might directly damage a third party's life, body or property, or when one of our products is intended for use in applications other than those specified in this catalog.

- ① Aircraft equipment
- ② Aerospace equipment
- ③ Undersea equipment
- ④ Power plant equipment
- ⑤ Medical equipment
- ⑥ Transportation equipment (vehicles, trains, ships, etc.)
- ⑦ Traffic signal equipment
- ⑧ Disaster prevention / crime prevention equipment
- ⑨ Data-processing equipment
- ⑩ Application of similar complexity and/or reliability requirements to the applications listed above

3 Product specifications in this catalog are as of May 2016. They are subject to change or our products in it may be discontinued without advance notice. Please check with our sales representatives or product engineers before ordering. If there are any questions, please contact our sales representatives or product engineers.

4 Please read rating and ⚠CAUTION (for storage, operating, rating, soldering, mounting and handling) in this catalog to prevent smoking and/or burning, etc.

5 This catalog has only typical specifications. Therefore, please approve our product specifications or transact the approval sheet for product specifications before ordering.

6 Please note that unless otherwise specified, we shall assume no responsibility whatsoever for any conflict or dispute that may occur in connection with the effect of our and/or a third party's intellectual property rights and other related rights in consideration of your use of our products and/or information described or contained in our catalogs. In this connection, no representation shall be made to the effect that any third parties are authorized to use the rights mentioned above under licenses without our consent.

7 No ozone depleting substances (ODS) under the Montreal Protocol are used in our manufacturing process.

Murata Manufacturing Co., Ltd.

www.murata.com

muRata
INNOVATOR IN ELECTRONICS