

### FEATURES

- UL 60950 recognised
- Industry standard footprint
- Efficiency to 82%
- 1kVDC Isolation 'Hi Pot Test'
- 2:1 wide input range
- Single isolated output
- Short circuit protection
- Low profile 24 pin case
- Operating temperature range -40°C to 85°C
- 5V, 12V, 24V & 48V input
- 3.3V, 5V, 9V, 12V & 15V output
- Internal SMD construction
- Fully encapsulated

### DESCRIPTION

The NDY series is a range of low profile DC/DC converters offering a single regulated output over a 2:1 input voltage range. All parts deliver 3W output power up to 85°C without heatsinking, except the 4.5V to 9V input voltage range which should be derated to 2W at the lower input voltage. A flyback oscillator design with isolated feedback is used to give regulation over the full operating range of 25% to 100% of full load. It is strongly recommended that external capacitors be used on input and output to guarantee performance over full load and input voltage range.

### SELECTION GUIDE

| Order code | Input voltage<br>V (Nom.) | Rated output voltage<br>V | Output current               |                 | Input current full load<br>mA | Efficiency <sup>2</sup> (Min.)<br>% | Isolation capacitance<br>pF | MTTF <sup>3</sup><br>kHrs |
|------------|---------------------------|---------------------------|------------------------------|-----------------|-------------------------------|-------------------------------------|-----------------------------|---------------------------|
|            |                           |                           | Min. Load <sup>1</sup><br>mA | Full load<br>mA |                               |                                     |                             |                           |
|            |                           |                           | Recommended                  |                 | In Production                 |                                     |                             |                           |
| NDY0505C   | 5                         | 5                         | 100-150                      | 400-600         | 615                           | 66                                  | 40                          | 1939                      |
| NDY0509C   | 5                         | 9                         | 55-83                        | 222-333         | 563                           | 72                                  | 52                          | 1926                      |
| NDY0512C   | 5                         | 12                        | 42-62                        | 166-250         | 548                           | 71                                  | 43                          | 1907                      |
| NDY0515C   | 5                         | 15                        | 33-50                        | 133-200         | 533                           | 73                                  | 44                          | 1924                      |
| NDY1205C   | 12                        | 5                         | 150                          | 600             | 362                           | 71                                  | 36                          | 1928                      |
| NDY1209C   | 12                        | 9                         | 83                           | 333             | 320                           | 78                                  | 52                          | 1916                      |
| NDY1212C   | 12                        | 12                        | 62                           | 250             | 316                           | 78                                  | 44                          | 1897                      |
| NDY1215C   | 12                        | 15                        | 50                           | 200             | 308                           | 79                                  | 47                          | 1914                      |
| NDY2403C   | 24                        | 3.3                       | 227                          | 909             | 178                           | 70                                  | 30                          | 1671                      |
| NDY2405C   | 24                        | 5                         | 150                          | 600             | 174                           | 70                                  | 36                          | 1673                      |
| NDY2409C   | 24                        | 9                         | 83                           | 333             | 156                           | 78                                  | 52                          | 1663                      |
| NDY2412C   | 24                        | 12                        | 62                           | 250             | 154                           | 80                                  | 44                          | 1644                      |
| NDY2415C   | 24                        | 15                        | 50                           | 200             | 150                           | 82                                  | 54                          | 1657                      |
| NDY4805C   | 48                        | 5                         | 150                          | 600             | 87                            | 73                                  | 35                          | 1668                      |
|            |                           |                           |                              |                 |                               |                                     |                             | To Be Discontinued        |
|            |                           |                           |                              |                 |                               |                                     |                             | Recommended Alternative   |
| NDY4803C   | 48                        | 3.3                       | 227                          | 909             | 87                            | 71                                  | 30                          | 1676                      |
| NDY4809C   | 48                        | 9                         | 83                           | 333             | 78                            | 80                                  | 52                          | 1663                      |
| NDY4812C   | 48                        | 12                        | 62                           | 250             | 77                            | 81                                  | 44                          | 1648                      |
| NDY4815C   | 48                        | 15                        | 50                           | 200             | 76                            | 81                                  | 53                          | 1661                      |

### INPUT CHARACTERISTICS

| Parameter                             | Conditions        | Min. | Typ. | Max. | Units  |
|---------------------------------------|-------------------|------|------|------|--------|
| Voltage range                         | All NDY05XX       | 4.5  | 5    | 9    | VDC    |
|                                       | All NDY12XX       | 9    | 12   | 18   |        |
|                                       | All NDY24XX       | 18   | 24   | 36   |        |
|                                       | All NDY48XX       | 36   | 48   | 72   |        |
| Reflected ripple current <sup>2</sup> | NDY2403           |      | 180  | 360  | mA p-p |
|                                       | NDY4803           |      | 140  | 290  |        |
|                                       | All NDY05XX       |      | 400  | 500  |        |
|                                       | All NDY12XX       |      | 150  | 170  |        |
|                                       | All other NDY24XX |      | 290  | 360  |        |
|                                       | All other NDY48XX |      | 100  | 127  |        |

### ABSOLUTE MAXIMUM RATINGS

|   |                   |
|---|-------------------|
| Short-circuit protection                        | Continuous        |
| Lead temperature 1.5mm from case for 10 seconds | 300°C             |
| Minimum load                                    | 25% of rated load |
| Input voltage 05 types                          | 10V               |
| Input voltage 12 types                          | 20V               |
| Input voltage 24 types                          | 40V               |
| Input voltage 48 types                          | 80V               |
| Internal dissipation                            | 1.7W              |

1. Refer to power derating graph.

2. Measured at full load with external input/output capacitors, refer to filter circuit 1.

3. Calculated using ML-HDBK-217F with nominal input voltage at full load (ground benign) at 25°C.

All specifications typical at T<sub>a</sub>=25°C, nominal input voltage and rated output current unless otherwise specified.



For full details go to  
[www.murata-ps.com/rohs](http://www.murata-ps.com/rohs)



| OUTPUT CHARACTERISTICS     |  |      |      |      |        |
|----------------------------|--|------|------|------|--------|
| Parameter                  | Conditions   | Min. | Typ. | Max. | Units  |
| Voltage set point accuracy | With external input/output capacitors  |      | ±1   | ±5   | %      |
| Line regulation            | Low line to high line, 3.3V output with external input/output capacitors       |      | 0.05 | 0.25 | %      |
|                            | Low line to high line, all other outputs with external input/output capacitors |      | 0.05 | 0.5  | %      |
| Load regulation            | 25% load to 100% load, 3.3V output with external input/output capacitors       |      | 0.6  | 1.0  | %      |
|                            | 25% load to 100% load, all other outputs with external input/output capacitors |      | 0.2  | 0.5  | %      |
| Ripple <sup>1</sup>        | BW = 20Hz to 300kHz, 3.3V output with external input/output capacitors         |      | 80   | 120  | mV rms |
|                            | BW = 20Hz to 300kHz, all other outputs with external input/output capacitors   |      | 5    | 10   |        |
| Noise <sup>1</sup>         | BW = DC to 100MHz, 3.3V output with external input/output capacitors           |      |      | 180  | mV p-p |
|                            | BW = DC to 20MHz, all other outputs with external input/output capacitors      |      | 50   | 100  |        |

| GENERAL CHARACTERISTICS |   |      |      |      |       |
|-------------------------|---|------|------|------|-------|
| Parameter               | Conditions                                    | Min. | Typ. | Max. | Units |
| Switching frequency     | 100% load $V_{IN}$ nominal 3.3V output        | 160  |      | 220  | kHz   |
|                         | 25% load $V_{IN}$ nominal 3.3V output         | 290  |      | 560  |       |
|                         | 100% load $V_{IN}$ nominal, all other outputs | 80   |      | 220  |       |
|                         | 25% load $V_{IN}$ nominal, all other outputs  | 290  |      | 560  |       |

| TEMPERATURE CHARACTERISTICS |                     |      |      |      |       |
|-----------------------------|---------------------|------|------|------|-------|
| Parameter                   | Conditions          | Min. | Typ. | Max. | Units |
| Operation                   | Ambient temperature | -40  |      | 85   | °C    |
| Storage                     |                     | -50  |      | 130  |       |
| Cooling                     | Free air convection |      |      |      |       |

| ISOLATION CHARACTERISTICS |                           |      |      |      |       |
|---------------------------|---------------------------|------|------|------|-------|
| Parameter                 | Conditions                | Min. | Typ. | Max. | Units |
| Isolation test voltage    | Flash tested for 1 second | 1000 |      |      | VDC   |
| Resistance                | Viso=500VDC               | 1    |      |      | GΩ    |

**TECHNICAL NOTES**

**ISOLATION VOLTAGE**

'Hi Pot Test', 'Flash Tested', 'Withstand Voltage', 'Proof Voltage', 'Dielectric Withstand Voltage' & 'Isolation Test Voltage' are all terms that relate to the same thing, a test voltage, applied for a specified time, across a component designed to provide electrical isolation, to verify the integrity of that isolation.

Murata Power Solutions NDY series of DC/DC converters are all 100% production tested at their stated isolation voltage. This is 1kVDC for 1 second.

A question commonly asked is, "What is the continuous voltage that can be applied across the part in normal operation?"

The NDY series has been recognized by Underwriters Laboratory for functional isolation. Both input and output should normally be maintained within SELV limits i.e. less than 42.4V peak, or 60VDC. The isolation test voltage represents a measure of immunity to transient voltages and the part should never be used as an element of a safety isolation system.

The part could be expected to function correctly with several hundred volts offset applied continuously across the isolation barrier; but then the circuitry on both sides of the barrier must be regarded as operating at an unsafe voltage and further isolation/insulation systems must form a barrier between these circuits and any user-accessible circuitry according to safety standard requirements.

**REPEATED HIGH-VOLTAGE ISOLATION TESTING**

It is well known that repeated high-voltage isolation testing of a barrier component can actually degrade isolation capability, to a lesser or greater degree depending on materials, construction and environment. The NDY series has an EI ferrite core, with no additional insulation between primary and secondary windings of enameled wire. While parts can be expected to withstand several times the stated test voltage, the isolation capability does depend on the wire insulation. Any material, including this enamel (typically polyurethane) is susceptible to eventual chemical degradation when subject to very high applied voltages thus implying that the number of tests should be strictly limited. We therefore strongly advise against repeated high voltage isolation testing, but if it is absolutely required, that the voltage be reduced by 20% from specified test voltage.

This consideration equally applies to agency recognized parts rated for better than functional isolation where the wire enamel insulation is always supplemented by a further insulation system of physical spacing or barriers.

**SAFETY APPROVAL**

The NDY series has been recognised by Underwriters Laboratory (UL) to UL 60950 for functional insulation for a maximum case temperature limit of 130°C (case temperature measured on the face opposite the pins). File number E151252 applies.

Note: This series gained UL 60950 recognition for products manufactured on or after datecode G1123, any NDY parts manufactured before this date code should not be considered UL 60950 recognized. Any NDY that is UL recognized will be printed with the UL logo. 

1. For lower ripple refer to circuit for reduced ripple.

**APPLICATION NOTES**

Recommended input & output capacitors

Although these converters will work without external capacitors, they are necessary in order to guarantee the full parametric performance over the full line and load range. All parts have been tested and characterized using the following values and test circuit.

| Input Voltage | C <sub>IN</sub>              | Output Voltage | C <sub>OUT</sub>             | L <sub>OUT</sub> |
|---------------|------------------------------|----------------|------------------------------|------------------|
| 5V, 12V       | 100µF, 25V (0.25Ω at 100KHz) | 3.3V           | 100µF, 25V (0.25Ω at 100KHz) | MPS# - 24100C    |
| 24V, 48V      | 10µF, 100V (1.5Ω at 100KHz)  | 5V, 12V, 15V   |                              | Not required     |

Test circuit, 5V, 12V and 15V output

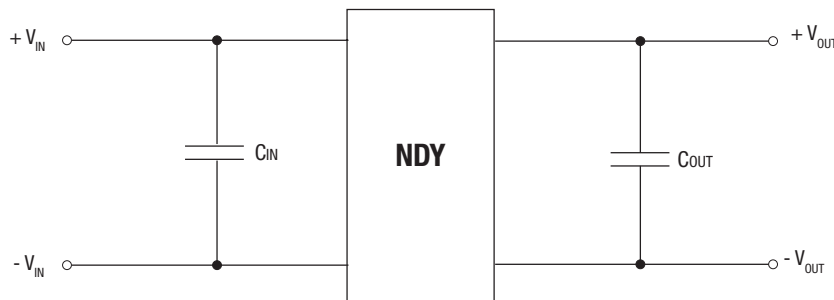

Recommended circuit for reduced ripple 3.3V output

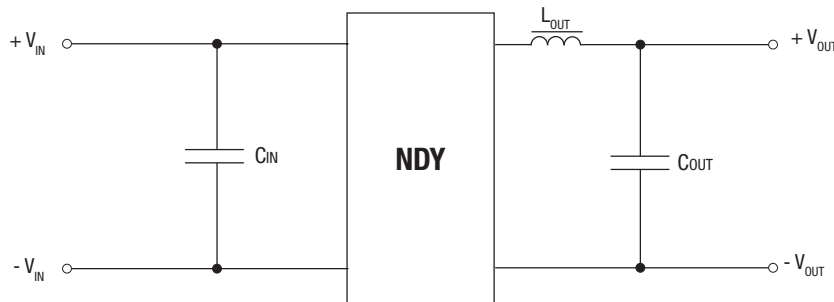

Output load

The minimum rated load across the whole input voltage range is 25% of the full load output. It is important to take care that the load does not fall below this as the output ripple will greatly increase. While this condition will not harm the device the resultant increase in output ripple could cause customers' application to malfunction.

**NDY05 POWER DERATING CURVE**

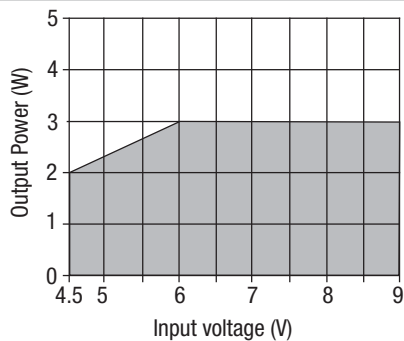

**RoHS COMPLIANCE INFORMATION**



This series is compatible with RoHS soldering systems with a peak wave solder temperature of 300°C for 10 seconds. The pin termination finish on this product series is Bright Tin. The series is backward compatible with Sn/Pb soldering systems.

For further information, please visit [www.murata-ps.com/rohs](http://www.murata-ps.com/rohs)

**PACKAGE SPECIFICATIONS**

**MECHANICAL DIMENSIONS**

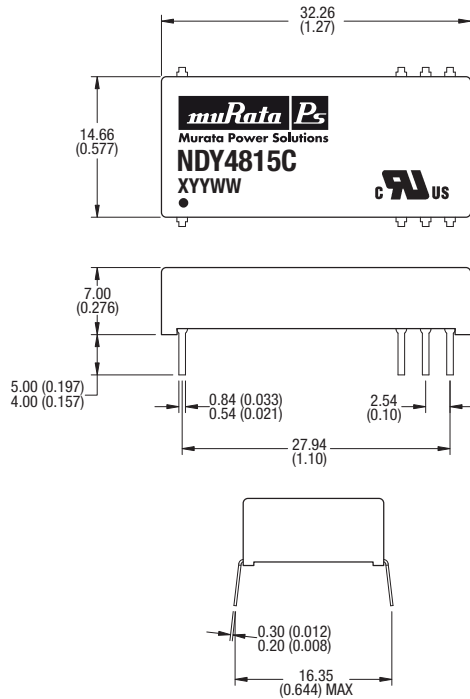

All dimensions in mm  $\pm 0.25$ mm (inches  $\pm 0.01$ ). All pins on a 2.54 (0.1) pitch and within  $\pm 0.25$  (0.01) of true position.

**PIN CONNECTIONS (TOP VIEW)**

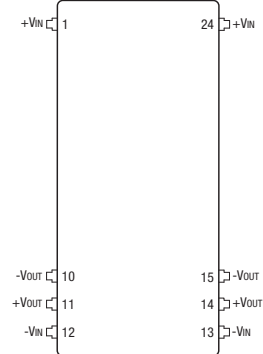

**RECOMMENDED FOOTPRINT DETAILS**

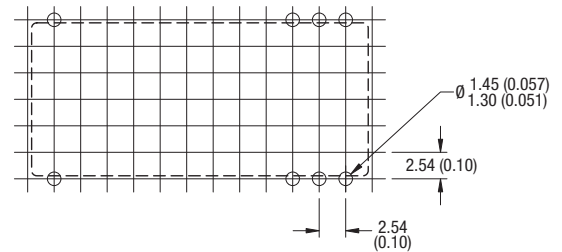

Unless otherwise stated all dimensions in mm  $\pm 0.5$ mm (inches  $\pm 0.01$ ).

**TUBE OUTLINE DIMENSIONS**

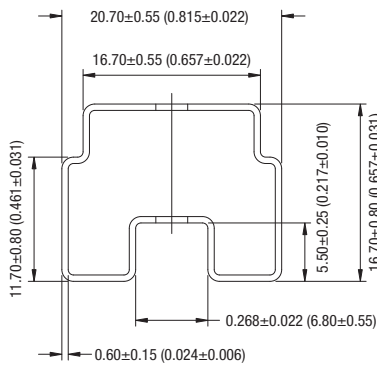

Unless otherwise stated all dimensions in mm  $\pm 0.5$ mm (inches  $\pm 0.01$ ).  
Tube length : 520mm  $\pm 2$ mm (20.47  $\pm 0.079$ ).

Tube Quantity : 15

Murata Power Solutions, Inc.  
11 Cabot Boulevard, Mansfield, MA 02048-1151 U.S.A.  
ISO 9001 and 14001 REGISTERED



This product is subject to the following **operating requirements** and the **Life and Safety Critical Application Sales Policy**:  
Refer to: <http://www.murata-ps.com/requirements/>

Murata Power Solutions, Inc. makes no representation that the use of its products in the circuits described herein, or the use of other technical information contained herein, will not infringe upon existing or future patent rights. The descriptions contained herein do not imply the granting of licenses to make, use, or sell equipment constructed in accordance therewith. Specifications are subject to change without notice.  
© 2017 Murata Power Solutions, Inc.