

Radial Lead Type Monolithic Ceramic Capacitors



● Part Numbering

Radial Lead Type Monolithic Ceramic Capacitors



① Product ID

② Series/Terminal

| Product ID | Series/Terminal | |
|------------|-----------------|---|
| RP | E | Radial Lead Type Monolithic Ceramic Capacitors (DC25V-DC100V) |
| RH | E/D | Radial Lead Type Monolithic Ceramic Capacitors 150°C max. (for Automotive) (DC50V-DC100V) |
| RD | E | Radial Lead Type Monolithic Ceramic Capacitors (For Commercial Use Only) (DC25V-DC630V) |

③ Temperature Characteristics

| Code | Temperature Characteristics | Reference Temperature | Temperature Range | Capacitance Change or Temperature Coefficient | Operating Temperature Range |
|------|-----------------------------|-----------------------|-------------------|---|-----------------------------|
| 5C | C0G* | 25°C | 25 to 125°C | 0±30ppm/°C | -55 to 125°C |
| 5G | X8G* | 25°C | 25 to 150°C | 0±30ppm/°C | -55 to 150°C |
| C7 | X7S | 25°C | -55 to 125°C | ±22% | -55 to 125°C |
| D7 | X7T | 25°C | -55 to 125°C | +22, -33% | -55 to 125°C |
| F1 | F | 20°C | -25 to 85°C | +30, -80% | -25 to 85°C |
| F5 | Y5V | 25°C | -30 to 85°C | +22, -82% | -30 to 85°C |
| L8 | X8L | 25°C | -55 to 125°C | ±15% | -55 to 150°C |
| | | | 125 to 150°C | +15, -40% | |
| R7 | X7R | 25°C | -55 to 125°C | ±15% | -55 to 125°C |

* Please refer to table for Capacitance change under reference temperature.

• Capacitance change from each temperature

| Char. | Nominal Values (ppm/°C) *1 | Capacitance Change from 25°C (%) | | | | | |
|-------|----------------------------|----------------------------------|-------|-------|-------|-------|-------|
| | | -55°C | | -30°C | | -10°C | |
| | | Max. | Min. | Max. | Min. | Max. | Min. |
| C0G | 0±30 | 0.58 | -0.24 | 0.40 | -0.17 | 0.25 | -0.11 |
| X8G | | | | | | | |

*1: Nominal values denote the temperature coefficient within a range of 25 to 125°C.

④ Rated Voltage

| Code | Rated Voltage |
|------|---------------|
| 1E | DC25V |
| 1H | DC50V |
| 2A | DC100V |
| 2E | DC250V |
| 2W | DC450V |
| 2J | DC630V |

⑤ Capacitance Tolerance

| Code | Capacitance Tolerance | Temperature Characteristics | Capacitance Step |
|------|-----------------------|-----------------------------|---------------------|
| C | ±0.25pF | C0G | ≤5pF : 1pF Step |
| D | ±0.5pF | | 6 to 9pF : 1pF Step |
| J | ±5% | C0G/X8G | ≥10 : E12 Series |
| K | ±10% | X7S/X7T/X7R/ X8L | E6 Series |
| M | ±20% | X7S/X7T/X7R/ X8L | E3 Series |
| Z | +80%, -20% | F/Y5V | E3 Series |

⑥ Capacitance

Expressed by three-digit alphanumerics. The unit is pico-farad (pF). The first and second figures are significant digits, and the third figure expresses the number of zeros that follow the two numbers.

If there is a decimal point, it is expressed by the capital letter "R."
 In this case, all figures are significant digits.

Continued on the following page.

☐ Continued from the preceding page.

⑦ Dimensions (LxW)

| Code | Dimensions (LxW) |
|----------|---|
| 0 | 4.0X3.5mm or 5.0X3.5mm (Depends on Part Number List) |
| 1 | 4.0X3.5mm or 4.5X3.5mm or 5.0X3.5mm (Depends on Part Number List) |
| 2 | 5.0X3.5mm or 5.5X4.0mm or 5.7X4.5mm (Depends on Part Number List) |
| 3 | 5.0X4.5mm or 5.5X5.0mm or 6.0X5.5mm (Depends on Part Number List) |
| 5 | 7.5X7.5mm* |
| 6 | 10.0X10.0mm |
| 7 | 12.5X12.5mm |
| 8 | 7.5X5.5mm |
| U | 7.7X12.5mm* |
| W | 5.5X7.5mm |

* DC630V: W+0.5mm

⑨ Lead Style

| Code | Lead Style | Lead Spacing |
|--------------|----------------------|--------------|
| A2 | Straight Long | 2.5mm |
| B1 | Straight Long | 5.0mm |
| C1 | Straight Long | 10.0mm |
| DB | Straight Taping | 2.5mm |
| E1/E2 | Straight Taping | 5.0mm |
| K1 | Inside Crimp | 5.0mm |
| M1/M2 | Inside Crimp Taping | 5.0mm |
| P1 | Outside Crimp | 2.5mm |
| S1/S2 | Outside Crimp Taping | 2.5mm |

Lead distance between reference and bottom planes.

M1, S1: H₀ = 16.0±0.5mm

M2, S2: H₀ = 20.0±0.5mm

E1: H = 17.5±0.5mm

E2: H = 20.0±0.5mm

⑩ Individual Specification Code

Expressed by three-digit alphanumerics

⑩ Packaging

| Code | Packaging |
|----------|-----------|
| A | Ammo Pack |
| B | Bulk |

Radial Lead Type Monolithic Ceramic Capacitors



RPE Series (DC25V-DC100V)

■ Features

1. The RPE series capacitors have small dimensions, large capacitance, and a capacity volume ratio of 10 micro F/cm cubed, close to that of electrolytic capacitors. They do not have polarity.
2. Excellent frequency characteristics and due to their small internal inductance are suitable for high frequencies.
3. Not coated with wax so there is no change in their exterior appearance due to the outflow of wax during soldering or solvent during cleansing.
4. They are highly nonflammable, having characteristics equivalent to the UL94V-0 standard.

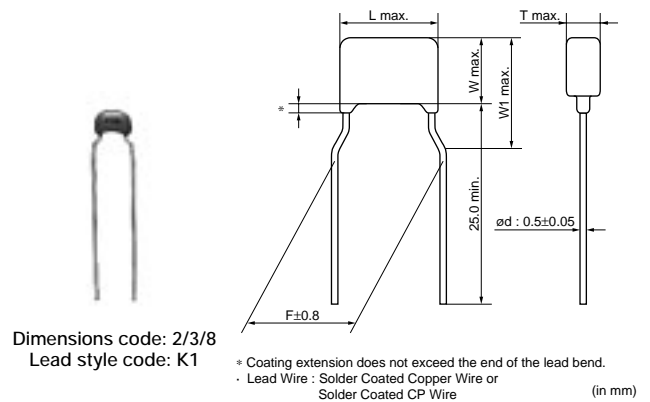
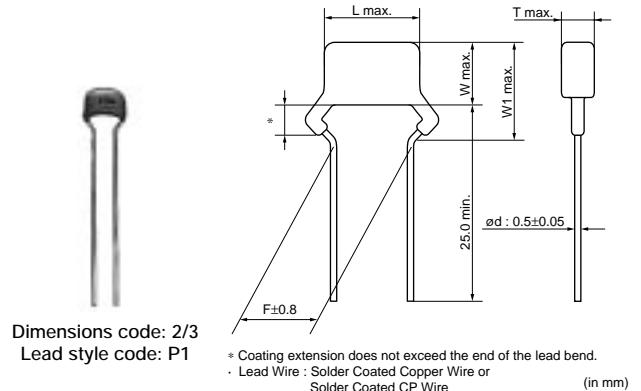

■ Dimensions



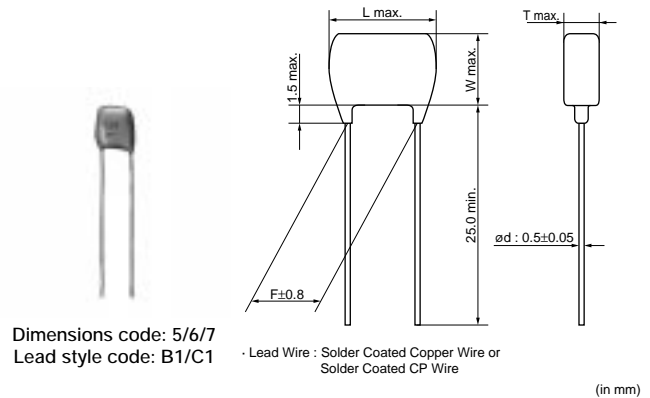





| Dimensions and Lead Style Code | Dimensions (mm) | | | | | |
|--------------------------------|-----------------|------|-----|---|------|-----|
| | L | W | W1 | T | F | d |
| 2P1/2S1/2S2 | 5.0 | 3.5 | 5.0 | See the individual product specifications | 2.5 | 0.5 |
| 2K1/2M1/2M2 | 5.0 | 3.5 | 5.0 | | 5.0 | 0.5 |
| 3P1/3S1/3S2 | 5.0 | 4.5 | 6.3 | | 2.5 | 0.5 |
| 3K1/3M1/3M2 | 5.0 | 4.5 | 6.3 | | 5.0 | 0.5 |
| 5B1/5E1/5E2 | 7.5 | 7.5 | - | | 5.0 | 0.5 |
| 6B1/6E1/6E2 | 10.0 | 10.0 | - | | 5.0 | 0.5 |
| 7C1 | 12.5 | 12.5 | - | | 10.0 | 0.5 |
| 8K1/8M1/8M2 | 7.5 | 5.5 | 8.0 | | 5.0 | 0.5 |

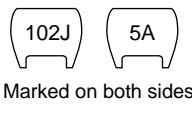

Continued on the following page.

Continued from the preceding page.

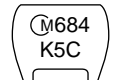
Marking

| Dimensions Code | Type | Temperature Compensating Type | High Dielectric Constant Type | |
|-------------------------------|---|---|---|---|
| | Temp. Char. | C0G | X7R | Y5V |
| 2 | Individual Specification Code A□□ B□□ Z□□ |  |  |  |
| | Individual Specification Code Except A□□ B□□ Z□□ |  |  |  |
| 3, 8 | | — |  | — |
| 5, 6, 7 | | — |  | — |
| Temperature Characteristics | Marked with code (C0G char.: A, X7R char.: C, Y5V char.: F) A part is omitted (Please refer to the marking example.) | | | |
| Nominal Capacitance | Under 100pF: Actual value 100pF and over: marked with 3 figures | | | |
| Capacitance Tolerance | Marked with code | | | |
| Rated Voltage | Marked with code (DC25V: 2, DC50V: 5, DC100V: 1) A part is omitted (Please refer to the marking example.) | | | |
| Manufacturer's Identification | Marked with  A part is omitted (Please refer to the marking example.) | | | |

Temperature Compensating Type, C0G Characteristics

| Part Number | Temp. Char. | Rated Voltage (Vdc) | Capacitance (pF) | Dimensions LxW (mm) | Dimension T (mm) | Lead Space F (mm) | Lead Style Code Bulk | Lead Style Code Taping (1) | Lead Style Code Taping (2) |
|--------------------|-------------|---------------------|------------------|---------------------|------------------|-------------------|----------------------|----------------------------|----------------------------|
| RPE5C1H1R0C2□□B03□ | C0G | 50 | 1.0 ±0.25pF | 5.0 x 3.5 | 2.5 | 2.5 | P1 | S1 | S2 |
| RPE5C1H1R0C2□□B03□ | C0G | 50 | 1.0 ±0.25pF | 5.0 x 3.5 | 2.5 | 5.0 | K1 | M1 | M2 |
| RPE5C1H2R0C2□□B03□ | C0G | 50 | 2.0 ±0.25pF | 5.0 x 3.5 | 2.5 | 2.5 | P1 | S1 | S2 |
| RPE5C1H2R0C2□□B03□ | C0G | 50 | 2.0 ±0.25pF | 5.0 x 3.5 | 2.5 | 5.0 | K1 | M1 | M2 |
| RPE5C1H3R0C2□□B03□ | C0G | 50 | 3.0 ±0.25pF | 5.0 x 3.5 | 2.5 | 2.5 | P1 | S1 | S2 |
| RPE5C1H3R0C2□□B03□ | C0G | 50 | 3.0 ±0.25pF | 5.0 x 3.5 | 2.5 | 5.0 | K1 | M1 | M2 |
| RPE5C1H4R0C2□□B03□ | C0G | 50 | 4.0 ±0.25pF | 5.0 x 3.5 | 2.5 | 2.5 | P1 | S1 | S2 |
| RPE5C1H4R0C2□□B03□ | C0G | 50 | 4.0 ±0.25pF | 5.0 x 3.5 | 2.5 | 5.0 | K1 | M1 | M2 |
| RPE5C1H5R0C2□□B03□ | C0G | 50 | 5.0 ±0.25pF | 5.0 x 3.5 | 2.5 | 2.5 | P1 | S1 | S2 |
| RPE5C1H5R0C2□□B03□ | C0G | 50 | 5.0 ±0.25pF | 5.0 x 3.5 | 2.5 | 5.0 | K1 | M1 | M2 |
| RPE5C1H6R0D2□□B03□ | C0G | 50 | 6.0 ±0.5pF | 5.0 x 3.5 | 2.5 | 2.5 | P1 | S1 | S2 |
| RPE5C1H6R0D2□□B03□ | C0G | 50 | 6.0 ±0.5pF | 5.0 x 3.5 | 2.5 | 5.0 | K1 | M1 | M2 |
| RPE5C1H7R0D2□□Z03□ | C0G | 50 | 7.0 ±0.5pF | 5.0 x 3.5 | 2.5 | 2.5 | P1 | S1 | S2 |
| RPE5C1H7R0D2□□Z03□ | C0G | 50 | 7.0 ±0.5pF | 5.0 x 3.5 | 2.5 | 5.0 | K1 | M1 | M2 |
| RPE5C1H8R0D2□□Z03□ | C0G | 50 | 8.0 ±0.5pF | 5.0 x 3.5 | 2.5 | 2.5 | P1 | S1 | S2 |
| RPE5C1H8R0D2□□Z03□ | C0G | 50 | 8.0 ±0.5pF | 5.0 x 3.5 | 2.5 | 5.0 | K1 | M1 | M2 |
| RPE5C1H9R0D2□□Z03□ | C0G | 50 | 9.0 ±0.5pF | 5.0 x 3.5 | 2.5 | 2.5 | P1 | S1 | S2 |
| RPE5C1H9R0D2□□Z03□ | C0G | 50 | 9.0 ±0.5pF | 5.0 x 3.5 | 2.5 | 5.0 | K1 | M1 | M2 |
| RPE5C1H100J2□□Z03□ | C0G | 50 | 10 ±5% | 5.0 x 3.5 | 2.5 | 2.5 | P1 | S1 | S2 |
| RPE5C1H100J2□□Z03□ | C0G | 50 | 10 ±5% | 5.0 x 3.5 | 2.5 | 5.0 | K1 | M1 | M2 |
| RPE5C1H120J2□□Z03□ | C0G | 50 | 12 ±5% | 5.0 x 3.5 | 2.5 | 2.5 | P1 | S1 | S2 |
| RPE5C1H120J2□□Z03□ | C0G | 50 | 12 ±5% | 5.0 x 3.5 | 2.5 | 5.0 | K1 | M1 | M2 |
| RPE5C1H150J2□□Z03□ | C0G | 50 | 15 ±5% | 5.0 x 3.5 | 2.5 | 2.5 | P1 | S1 | S2 |
| RPE5C1H150J2□□Z03□ | C0G | 50 | 15 ±5% | 5.0 x 3.5 | 2.5 | 5.0 | K1 | M1 | M2 |
| RPE5C1H180J2□□Z03□ | C0G | 50 | 18 ±5% | 5.0 x 3.5 | 2.5 | 2.5 | P1 | S1 | S2 |
| RPE5C1H180J2□□Z03□ | C0G | 50 | 18 ±5% | 5.0 x 3.5 | 2.5 | 5.0 | K1 | M1 | M2 |
| RPE5C1H220J2□□Z03□ | C0G | 50 | 22 ±5% | 5.0 x 3.5 | 2.5 | 2.5 | P1 | S1 | S2 |
| RPE5C1H220J2□□Z03□ | C0G | 50 | 22 ±5% | 5.0 x 3.5 | 2.5 | 5.0 | K1 | M1 | M2 |
| RPE5C1H270J2□□Z03□ | C0G | 50 | 27 ±5% | 5.0 x 3.5 | 2.5 | 2.5 | P1 | S1 | S2 |
| RPE5C1H270J2□□Z03□ | C0G | 50 | 27 ±5% | 5.0 x 3.5 | 2.5 | 5.0 | K1 | M1 | M2 |
| RPE5C1H330J2□□Z03□ | C0G | 50 | 33 ±5% | 5.0 x 3.5 | 2.5 | 2.5 | P1 | S1 | S2 |
| RPE5C1H330J2□□Z03□ | C0G | 50 | 33 ±5% | 5.0 x 3.5 | 2.5 | 5.0 | K1 | M1 | M2 |
| RPE5C1H390J2□□Z03□ | C0G | 50 | 39 ±5% | 5.0 x 3.5 | 2.5 | 2.5 | P1 | S1 | S2 |
| RPE5C1H390J2□□Z03□ | C0G | 50 | 39 ±5% | 5.0 x 3.5 | 2.5 | 5.0 | K1 | M1 | M2 |
| RPE5C1H470J2□□Z03□ | C0G | 50 | 47 ±5% | 5.0 x 3.5 | 2.5 | 2.5 | P1 | S1 | S2 |
| RPE5C1H470J2□□Z03□ | C0G | 50 | 47 ±5% | 5.0 x 3.5 | 2.5 | 5.0 | K1 | M1 | M2 |
| RPE5C1H560J2□□Z03□ | C0G | 50 | 56 ±5% | 5.0 x 3.5 | 2.5 | 2.5 | P1 | S1 | S2 |
| RPE5C1H560J2□□Z03□ | C0G | 50 | 56 ±5% | 5.0 x 3.5 | 2.5 | 5.0 | K1 | M1 | M2 |
| RPE5C1H680J2□□Z03□ | C0G | 50 | 68 ±5% | 5.0 x 3.5 | 2.5 | 2.5 | P1 | S1 | S2 |
| RPE5C1H680J2□□Z03□ | C0G | 50 | 68 ±5% | 5.0 x 3.5 | 2.5 | 5.0 | K1 | M1 | M2 |
| RPE5C1H820J2□□Z03□ | C0G | 50 | 82 ±5% | 5.0 x 3.5 | 2.5 | 2.5 | P1 | S1 | S2 |
| RPE5C1H820J2□□Z03□ | C0G | 50 | 82 ±5% | 5.0 x 3.5 | 2.5 | 5.0 | K1 | M1 | M2 |
| RPE5C1H101J2□□A03□ | C0G | 50 | 100 ±5% | 5.0 x 3.5 | 2.5 | 2.5 | P1 | S1 | S2 |
| RPE5C1H101J2□□A03□ | C0G | 50 | 100 ±5% | 5.0 x 3.5 | 2.5 | 5.0 | K1 | M1 | M2 |
| RPE5C1H121J2□□A03□ | C0G | 50 | 120 ±5% | 5.0 x 3.5 | 2.5 | 2.5 | P1 | S1 | S2 |
| RPE5C1H121J2□□A03□ | C0G | 50 | 120 ±5% | 5.0 x 3.5 | 2.5 | 5.0 | K1 | M1 | M2 |
| RPE5C1H151J2□□A03□ | C0G | 50 | 150 ±5% | 5.0 x 3.5 | 2.5 | 2.5 | P1 | S1 | S2 |
| RPE5C1H151J2□□A03□ | C0G | 50 | 150 ±5% | 5.0 x 3.5 | 2.5 | 5.0 | K1 | M1 | M2 |
| RPE5C1H181J2□□A03□ | C0G | 50 | 180 ±5% | 5.0 x 3.5 | 2.5 | 2.5 | P1 | S1 | S2 |
| RPE5C1H181J2□□A03□ | C0G | 50 | 180 ±5% | 5.0 x 3.5 | 2.5 | 5.0 | K1 | M1 | M2 |
| RPE5C1H221J2□□A03□ | C0G | 50 | 220 ±5% | 5.0 x 3.5 | 2.5 | 2.5 | P1 | S1 | S2 |
| RPE5C1H221J2□□A03□ | C0G | 50 | 220 ±5% | 5.0 x 3.5 | 2.5 | 5.0 | K1 | M1 | M2 |
| RPE5C1H271J2□□A03□ | C0G | 50 | 270 ±5% | 5.0 x 3.5 | 2.5 | 2.5 | P1 | S1 | S2 |
| RPE5C1H271J2□□A03□ | C0G | 50 | 270 ±5% | 5.0 x 3.5 | 2.5 | 5.0 | K1 | M1 | M2 |

Continued on the following page.

Continued from the preceding page.

| Part Number | Temp. Char. | Rated Voltage (Vdc) | Capacitance (pF) | Dimensions LxW (mm) | Dimension T (mm) | Lead Space F (mm) | Lead Style Code Bulk | Lead Style Code Taping (1) | Lead Style Code Taping (2) |
|--------------------|-------------|---------------------|------------------|---------------------|------------------|-------------------|----------------------|----------------------------|----------------------------|
| RPE5C1H331J2□□A03□ | COG | 50 | 330 ±5% | 5.0 x 3.5 | 2.5 | 2.5 | P1 | S1 | S2 |
| RPE5C1H331J2□□A03□ | COG | 50 | 330 ±5% | 5.0 x 3.5 | 2.5 | 5.0 | K1 | M1 | M2 |
| RPE5C1H391J2□□A03□ | COG | 50 | 390 ±5% | 5.0 x 3.5 | 2.5 | 2.5 | P1 | S1 | S2 |
| RPE5C1H391J2□□A03□ | COG | 50 | 390 ±5% | 5.0 x 3.5 | 2.5 | 5.0 | K1 | M1 | M2 |
| RPE5C1H471J2□□A03□ | COG | 50 | 470 ±5% | 5.0 x 3.5 | 2.5 | 2.5 | P1 | S1 | S2 |
| RPE5C1H471J2□□A03□ | COG | 50 | 470 ±5% | 5.0 x 3.5 | 2.5 | 5.0 | K1 | M1 | M2 |
| RPE5C1H561J2□□A03□ | COG | 50 | 560 ±5% | 5.0 x 3.5 | 2.5 | 2.5 | P1 | S1 | S2 |
| RPE5C1H561J2□□A03□ | COG | 50 | 560 ±5% | 5.0 x 3.5 | 2.5 | 5.0 | K1 | M1 | M2 |
| RPE5C1H681J2□□A03□ | COG | 50 | 680 ±5% | 5.0 x 3.5 | 2.5 | 2.5 | P1 | S1 | S2 |
| RPE5C1H681J2□□A03□ | COG | 50 | 680 ±5% | 5.0 x 3.5 | 2.5 | 5.0 | K1 | M1 | M2 |
| RPE5C1H821J2□□A03□ | COG | 50 | 820 ±5% | 5.0 x 3.5 | 2.5 | 2.5 | P1 | S1 | S2 |
| RPE5C1H821J2□□A03□ | COG | 50 | 820 ±5% | 5.0 x 3.5 | 2.5 | 5.0 | K1 | M1 | M2 |
| RPE5C1H102J2□□A03□ | COG | 50 | 1000 ±5% | 5.0 x 3.5 | 2.5 | 2.5 | P1 | S1 | S2 |
| RPE5C1H102J2□□A03□ | COG | 50 | 1000 ±5% | 5.0 x 3.5 | 2.5 | 5.0 | K1 | M1 | M2 |
| RPE5C1H122J2□□A03□ | COG | 50 | 1200 ±5% | 5.0 x 3.5 | 3.15 | 2.5 | P1 | S1 | S2 |
| RPE5C1H122J2□□A03□ | COG | 50 | 1200 ±5% | 5.0 x 3.5 | 3.15 | 5.0 | K1 | M1 | M2 |
| RPE5C1H152J2□□A03□ | COG | 50 | 1500 ±5% | 5.0 x 3.5 | 3.15 | 2.5 | P1 | S1 | S2 |
| RPE5C1H152J2□□A03□ | COG | 50 | 1500 ±5% | 5.0 x 3.5 | 3.15 | 5.0 | K1 | M1 | M2 |
| RPE5C1H182J2□□C03□ | COG | 50 | 1800 ±5% | 5.0 x 3.5 | 3.15 | 2.5 | P1 | S1 | S2 |
| RPE5C1H182J2□□A03□ | COG | 50 | 1800 ±5% | 5.0 x 3.5 | 3.15 | 5.0 | K1 | M1 | M2 |
| RPE5C1H222J2□□C03□ | COG | 50 | 2200 ±5% | 5.0 x 3.5 | 3.15 | 2.5 | P1 | S1 | S2 |
| RPE5C1H222J2□□A03□ | COG | 50 | 2200 ±5% | 5.0 x 3.5 | 3.15 | 5.0 | K1 | M1 | M2 |
| RPE5C1H272J2□□C03□ | COG | 50 | 2700 ±5% | 5.0 x 3.5 | 3.15 | 2.5 | P1 | S1 | S2 |
| RPE5C1H272J2□□A03□ | COG | 50 | 2700 ±5% | 5.0 x 3.5 | 3.15 | 5.0 | K1 | M1 | M2 |
| RPE5C1H332J2□□C03□ | COG | 50 | 3300 ±5% | 5.0 x 3.5 | 3.15 | 2.5 | P1 | S1 | S2 |
| RPE5C1H332J2□□A03□ | COG | 50 | 3300 ±5% | 5.0 x 3.5 | 3.15 | 5.0 | K1 | M1 | M2 |
| RPE5C1H392J2□□C03□ | COG | 50 | 3900 ±5% | 5.0 x 3.5 | 3.15 | 2.5 | P1 | S1 | S2 |
| RPE5C1H392J2□□A03□ | COG | 50 | 3900 ±5% | 5.0 x 3.5 | 3.15 | 5.0 | K1 | M1 | M2 |
| RPE5C1H472J2□□C03□ | COG | 50 | 4700 ±5% | 5.0 x 3.5 | 3.15 | 2.5 | P1 | S1 | S2 |
| RPE5C1H472J2□□A03□ | COG | 50 | 4700 ±5% | 5.0 x 3.5 | 3.15 | 5.0 | K1 | M1 | M2 |
| RPE5C1H562J2□□C03□ | COG | 50 | 5600 ±5% | 5.0 x 3.5 | 3.15 | 2.5 | P1 | S1 | S2 |
| RPE5C1H562J2□□A03□ | COG | 50 | 5600 ±5% | 5.0 x 3.5 | 3.15 | 5.0 | K1 | M1 | M2 |
| RPE5C1H682J2□□C03□ | COG | 50 | 6800 ±5% | 5.0 x 3.5 | 3.15 | 5.0 | K1 | M1 | M2 |
| RPE5C1H822J2□□C03□ | COG | 50 | 8200 ±5% | 5.0 x 3.5 | 3.15 | 5.0 | K1 | M1 | M2 |
| RPE5C1H103J2□□C03□ | COG | 50 | 10000 ±5% | 5.0 x 3.5 | 3.15 | 5.0 | K1 | M1 | M2 |
| RPE5C2A1R0C2□□B03□ | COG | 100 | 1.0 ±0.25pF | 5.0 x 3.5 | 2.5 | 2.5 | P1 | S1 | S2 |
| RPE5C2A1R0C2□□B03□ | COG | 100 | 1.0 ±0.25pF | 5.0 x 3.5 | 2.5 | 5.0 | K1 | M1 | M2 |
| RPE5C2A2R0C2□□B03□ | COG | 100 | 2.0 ±0.25pF | 5.0 x 3.5 | 2.5 | 2.5 | P1 | S1 | S2 |
| RPE5C2A2R0C2□□B03□ | COG | 100 | 2.0 ±0.25pF | 5.0 x 3.5 | 2.5 | 5.0 | K1 | M1 | M2 |
| RPE5C2A3R0C2□□B03□ | COG | 100 | 3.0 ±0.25pF | 5.0 x 3.5 | 2.5 | 2.5 | P1 | S1 | S2 |
| RPE5C2A3R0C2□□B03□ | COG | 100 | 3.0 ±0.25pF | 5.0 x 3.5 | 2.5 | 5.0 | K1 | M1 | M2 |
| RPE5C2A4R0C2□□B03□ | COG | 100 | 4.0 ±0.25pF | 5.0 x 3.5 | 2.5 | 2.5 | P1 | S1 | S2 |
| RPE5C2A4R0C2□□B03□ | COG | 100 | 4.0 ±0.25pF | 5.0 x 3.5 | 2.5 | 5.0 | K1 | M1 | M2 |
| RPE5C2A5R0C2□□B03□ | COG | 100 | 5.0 ±0.25pF | 5.0 x 3.5 | 2.5 | 2.5 | P1 | S1 | S2 |
| RPE5C2A5R0C2□□B03□ | COG | 100 | 5.0 ±0.25pF | 5.0 x 3.5 | 2.5 | 5.0 | K1 | M1 | M2 |
| RPE5C2A6R0D2□□B03□ | COG | 100 | 6.0 ±0.5pF | 5.0 x 3.5 | 2.5 | 2.5 | P1 | S1 | S2 |
| RPE5C2A6R0D2□□B03□ | COG | 100 | 6.0 ±0.5pF | 5.0 x 3.5 | 2.5 | 5.0 | K1 | M1 | M2 |
| RPE5C2A7R0D2□□Z03□ | COG | 100 | 7.0 ±0.5pF | 5.0 x 3.5 | 2.5 | 2.5 | P1 | S1 | S2 |
| RPE5C2A7R0D2□□Z03□ | COG | 100 | 7.0 ±0.5pF | 5.0 x 3.5 | 2.5 | 5.0 | K1 | M1 | M2 |
| RPE5C2A8R0D2□□Z03□ | COG | 100 | 8.0 ±0.5pF | 5.0 x 3.5 | 2.5 | 2.5 | P1 | S1 | S2 |
| RPE5C2A8R0D2□□Z03□ | COG | 100 | 8.0 ±0.5pF | 5.0 x 3.5 | 2.5 | 5.0 | K1 | M1 | M2 |
| RPE5C2A9R0D2□□Z03□ | COG | 100 | 9.0 ±0.5pF | 5.0 x 3.5 | 2.5 | 2.5 | P1 | S1 | S2 |
| RPE5C2A9R0D2□□Z03□ | COG | 100 | 9.0 ±0.5pF | 5.0 x 3.5 | 2.5 | 5.0 | K1 | M1 | M2 |
| RPE5C2A100J2□□Z03□ | COG | 100 | 10 ±5% | 5.0 x 3.5 | 2.5 | 2.5 | P1 | S1 | S2 |
| RPE5C2A100J2□□Z03□ | COG | 100 | 10 ±5% | 5.0 x 3.5 | 2.5 | 5.0 | K1 | M1 | M2 |
| RPE5C2A120J2□□Z03□ | COG | 100 | 12 ±5% | 5.0 x 3.5 | 2.5 | 2.5 | P1 | S1 | S2 |
| RPE5C2A120J2□□Z03□ | COG | 100 | 12 ±5% | 5.0 x 3.5 | 2.5 | 5.0 | K1 | M1 | M2 |

Continued on the following page.

Continued from the preceding page.

| Part Number | Temp. Char. | Rated Voltage (Vdc) | Capacitance (pF) | Dimensions LxW (mm) | Dimension T (mm) | Lead Space F (mm) | Lead Style Code Bulk | Lead Style Code Taping (1) | Lead Style Code Taping (2) |
|--------------------|-------------|---------------------|------------------|---------------------|------------------|-------------------|----------------------|----------------------------|----------------------------|
| RPE5C2A150J2□□Z03□ | COG | 100 | 15 ±5% | 5.0 x 3.5 | 2.5 | 2.5 | P1 | S1 | S2 |
| RPE5C2A150J2□□Z03□ | COG | 100 | 15 ±5% | 5.0 x 3.5 | 2.5 | 5.0 | K1 | M1 | M2 |
| RPE5C2A180J2□□Z03□ | COG | 100 | 18 ±5% | 5.0 x 3.5 | 2.5 | 2.5 | P1 | S1 | S2 |
| RPE5C2A180J2□□Z03□ | COG | 100 | 18 ±5% | 5.0 x 3.5 | 2.5 | 5.0 | K1 | M1 | M2 |
| RPE5C2A220J2□□Z03□ | COG | 100 | 22 ±5% | 5.0 x 3.5 | 2.5 | 2.5 | P1 | S1 | S2 |
| RPE5C2A220J2□□Z03□ | COG | 100 | 22 ±5% | 5.0 x 3.5 | 2.5 | 5.0 | K1 | M1 | M2 |
| RPE5C2A270J2□□Z03□ | COG | 100 | 27 ±5% | 5.0 x 3.5 | 2.5 | 2.5 | P1 | S1 | S2 |
| RPE5C2A270J2□□Z03□ | COG | 100 | 27 ±5% | 5.0 x 3.5 | 2.5 | 5.0 | K1 | M1 | M2 |
| RPE5C2A330J2□□Z03□ | COG | 100 | 33 ±5% | 5.0 x 3.5 | 2.5 | 2.5 | P1 | S1 | S2 |
| RPE5C2A330J2□□Z03□ | COG | 100 | 33 ±5% | 5.0 x 3.5 | 2.5 | 5.0 | K1 | M1 | M2 |
| RPE5C2A390J2□□Z03□ | COG | 100 | 39 ±5% | 5.0 x 3.5 | 2.5 | 2.5 | P1 | S1 | S2 |
| RPE5C2A390J2□□Z03□ | COG | 100 | 39 ±5% | 5.0 x 3.5 | 2.5 | 5.0 | K1 | M1 | M2 |
| RPE5C2A470J2□□Z03□ | COG | 100 | 47 ±5% | 5.0 x 3.5 | 2.5 | 2.5 | P1 | S1 | S2 |
| RPE5C2A470J2□□Z03□ | COG | 100 | 47 ±5% | 5.0 x 3.5 | 2.5 | 5.0 | K1 | M1 | M2 |
| RPE5C2A560J2□□Z03□ | COG | 100 | 56 ±5% | 5.0 x 3.5 | 2.5 | 2.5 | P1 | S1 | S2 |
| RPE5C2A560J2□□Z03□ | COG | 100 | 56 ±5% | 5.0 x 3.5 | 2.5 | 5.0 | K1 | M1 | M2 |
| RPE5C2A680J2□□Z03□ | COG | 100 | 68 ±5% | 5.0 x 3.5 | 2.5 | 2.5 | P1 | S1 | S2 |
| RPE5C2A680J2□□Z03□ | COG | 100 | 68 ±5% | 5.0 x 3.5 | 2.5 | 5.0 | K1 | M1 | M2 |
| RPE5C2A820J2□□Z03□ | COG | 100 | 82 ±5% | 5.0 x 3.5 | 2.5 | 2.5 | P1 | S1 | S2 |
| RPE5C2A820J2□□Z03□ | COG | 100 | 82 ±5% | 5.0 x 3.5 | 2.5 | 5.0 | K1 | M1 | M2 |
| RPE5C2A101J2□□A03□ | COG | 100 | 100 ±5% | 5.0 x 3.5 | 2.5 | 2.5 | P1 | S1 | S2 |
| RPE5C2A101J2□□A03□ | COG | 100 | 100 ±5% | 5.0 x 3.5 | 2.5 | 5.0 | K1 | M1 | M2 |
| RPE5C2A121J2□□A03□ | COG | 100 | 120 ±5% | 5.0 x 3.5 | 2.5 | 2.5 | P1 | S1 | S2 |
| RPE5C2A121J2□□A03□ | COG | 100 | 120 ±5% | 5.0 x 3.5 | 2.5 | 5.0 | K1 | M1 | M2 |
| RPE5C2A151J2□□A03□ | COG | 100 | 150 ±5% | 5.0 x 3.5 | 2.5 | 2.5 | P1 | S1 | S2 |
| RPE5C2A151J2□□A03□ | COG | 100 | 150 ±5% | 5.0 x 3.5 | 2.5 | 5.0 | K1 | M1 | M2 |
| RPE5C2A181J2□□A03□ | COG | 100 | 180 ±5% | 5.0 x 3.5 | 2.5 | 2.5 | P1 | S1 | S2 |
| RPE5C2A181J2□□A03□ | COG | 100 | 180 ±5% | 5.0 x 3.5 | 2.5 | 5.0 | K1 | M1 | M2 |
| RPE5C2A221J2□□A03□ | COG | 100 | 220 ±5% | 5.0 x 3.5 | 2.5 | 2.5 | P1 | S1 | S2 |
| RPE5C2A221J2□□A03□ | COG | 100 | 220 ±5% | 5.0 x 3.5 | 2.5 | 5.0 | K1 | M1 | M2 |
| RPE5C2A271J2□□A03□ | COG | 100 | 270 ±5% | 5.0 x 3.5 | 2.5 | 2.5 | P1 | S1 | S2 |
| RPE5C2A271J2□□A03□ | COG | 100 | 270 ±5% | 5.0 x 3.5 | 2.5 | 5.0 | K1 | M1 | M2 |
| RPE5C2A331J2□□A03□ | COG | 100 | 330 ±5% | 5.0 x 3.5 | 2.5 | 2.5 | P1 | S1 | S2 |
| RPE5C2A331J2□□A03□ | COG | 100 | 330 ±5% | 5.0 x 3.5 | 2.5 | 5.0 | K1 | M1 | M2 |
| RPE5C2A391J2□□A03□ | COG | 100 | 390 ±5% | 5.0 x 3.5 | 2.5 | 2.5 | P1 | S1 | S2 |
| RPE5C2A391J2□□A03□ | COG | 100 | 390 ±5% | 5.0 x 3.5 | 2.5 | 5.0 | K1 | M1 | M2 |
| RPE5C2A471J2□□A03□ | COG | 100 | 470 ±5% | 5.0 x 3.5 | 2.5 | 2.5 | P1 | S1 | S2 |
| RPE5C2A471J2□□A03□ | COG | 100 | 470 ±5% | 5.0 x 3.5 | 2.5 | 5.0 | K1 | M1 | M2 |
| RPE5C2A561J2□□A03□ | COG | 100 | 560 ±5% | 5.0 x 3.5 | 2.5 | 2.5 | P1 | S1 | S2 |
| RPE5C2A561J2□□A03□ | COG | 100 | 560 ±5% | 5.0 x 3.5 | 2.5 | 5.0 | K1 | M1 | M2 |
| RPE5C2A681J2□□A03□ | COG | 100 | 680 ±5% | 5.0 x 3.5 | 2.5 | 2.5 | P1 | S1 | S2 |
| RPE5C2A681J2□□A03□ | COG | 100 | 680 ±5% | 5.0 x 3.5 | 2.5 | 5.0 | K1 | M1 | M2 |
| RPE5C2A821J2□□A03□ | COG | 100 | 820 ±5% | 5.0 x 3.5 | 3.15 | 2.5 | P1 | S1 | S2 |
| RPE5C2A821J2□□A03□ | COG | 100 | 820 ±5% | 5.0 x 3.5 | 3.15 | 5.0 | K1 | M1 | M2 |
| RPE5C2A102J2□□A03□ | COG | 100 | 1000 ±5% | 5.0 x 3.5 | 3.15 | 2.5 | P1 | S1 | S2 |
| RPE5C2A102J2□□A03□ | COG | 100 | 1000 ±5% | 5.0 x 3.5 | 3.15 | 5.0 | K1 | M1 | M2 |
| RPE5C2A122J2□□A03□ | COG | 100 | 1200 ±5% | 5.0 x 3.5 | 3.15 | 2.5 | P1 | S1 | S2 |
| RPE5C2A122J2□□A03□ | COG | 100 | 1200 ±5% | 5.0 x 3.5 | 3.15 | 5.0 | K1 | M1 | M2 |
| RPE5C2A152J2□□A03□ | COG | 100 | 1500 ±5% | 5.0 x 3.5 | 3.15 | 2.5 | P1 | S1 | S2 |
| RPE5C2A152J2□□A03□ | COG | 100 | 1500 ±5% | 5.0 x 3.5 | 3.15 | 5.0 | K1 | M1 | M2 |

Two blank columns are filled with the lead style code. Please refer to the 3 columns on the right for the appropriate code.
 The last blank column is filled with the packaging code. (B: bulk, A: ammo pack)

High Dielectric Constant Type, X7R Characteristics

| Part Number | Temp. Char. | Rated Voltage (Vdc) | Capacitance | Dimensions LxW (mm) | Dimension T (mm) | Lead Space F (mm) | Lead Style Code Bulk | Lead Style Code Taping (1) | Lead Style Code Taping (2) |
|--------------------|-------------|---------------------|--------------|---------------------|------------------|-------------------|----------------------|----------------------------|----------------------------|
| RPER71E474K2□□A03□ | X7R | 25 | 0.47μF ±10% | 5.0 x 3.5 | 3.15 | 5.0 | K1 | M1 | M2 |
| RPER71E684K2□□C03□ | X7R | 25 | 0.68μF ±10% | 5.0 x 3.5 | 3.15 | 5.0 | K1 | M1 | M2 |
| RPER71E105K2□□C03□ | X7R | 25 | 1.0μF ±10% | 5.0 x 3.5 | 3.15 | 5.0 | K1 | M1 | M2 |
| RPER71E155K3□□C07□ | X7R | 25 | 1.5μF ±10% | 5.0 x 4.5 | 3.15 | 5.0 | K1 | M1 | M2 |
| RPER71E225K3□□C07□ | X7R | 25 | 2.2μF ±10% | 5.0 x 4.5 | 3.15 | 5.0 | K1 | M1 | M2 |
| RPER71H221K2□□A03□ | X7R | 50 | 220pF ±10% | 5.0 x 3.5 | 2.5 | 2.5 | P1 | S1 | S2 |
| RPER71H221K2□□A03□ | X7R | 50 | 220pF ±10% | 5.0 x 3.5 | 2.5 | 5.0 | K1 | M1 | M2 |
| RPER71H331K2□□A03□ | X7R | 50 | 330pF ±10% | 5.0 x 3.5 | 2.5 | 2.5 | P1 | S1 | S2 |
| RPER71H331K2□□A03□ | X7R | 50 | 330pF ±10% | 5.0 x 3.5 | 2.5 | 5.0 | K1 | M1 | M2 |
| RPER71H471K2□□A03□ | X7R | 50 | 470pF ±10% | 5.0 x 3.5 | 2.5 | 2.5 | P1 | S1 | S2 |
| RPER71H471K2□□A03□ | X7R | 50 | 470pF ±10% | 5.0 x 3.5 | 2.5 | 5.0 | K1 | M1 | M2 |
| RPER71H681K2□□A03□ | X7R | 50 | 680pF ±10% | 5.0 x 3.5 | 2.5 | 2.5 | P1 | S1 | S2 |
| RPER71H681K2□□A03□ | X7R | 50 | 680pF ±10% | 5.0 x 3.5 | 2.5 | 5.0 | K1 | M1 | M2 |
| RPER71H102K2□□A03□ | X7R | 50 | 1000pF ±10% | 5.0 x 3.5 | 2.5 | 2.5 | P1 | S1 | S2 |
| RPER71H102K2□□A03□ | X7R | 50 | 1000pF ±10% | 5.0 x 3.5 | 2.5 | 5.0 | K1 | M1 | M2 |
| RPER71H152K2□□A03□ | X7R | 50 | 1500pF ±10% | 5.0 x 3.5 | 2.5 | 2.5 | P1 | S1 | S2 |
| RPER71H152K2□□A03□ | X7R | 50 | 1500pF ±10% | 5.0 x 3.5 | 2.5 | 5.0 | K1 | M1 | M2 |
| RPER71H222K2□□A03□ | X7R | 50 | 2200pF ±10% | 5.0 x 3.5 | 2.5 | 2.5 | P1 | S1 | S2 |
| RPER71H222K2□□A03□ | X7R | 50 | 2200pF ±10% | 5.0 x 3.5 | 2.5 | 5.0 | K1 | M1 | M2 |
| RPER71H332K2□□A03□ | X7R | 50 | 3300pF ±10% | 5.0 x 3.5 | 2.5 | 2.5 | P1 | S1 | S2 |
| RPER71H332K2□□A03□ | X7R | 50 | 3300pF ±10% | 5.0 x 3.5 | 2.5 | 5.0 | K1 | M1 | M2 |
| RPER71H472K2□□A03□ | X7R | 50 | 4700pF ±10% | 5.0 x 3.5 | 2.5 | 2.5 | P1 | S1 | S2 |
| RPER71H472K2□□A03□ | X7R | 50 | 4700pF ±10% | 5.0 x 3.5 | 2.5 | 5.0 | K1 | M1 | M2 |
| RPER71H682K2□□A03□ | X7R | 50 | 6800pF ±10% | 5.0 x 3.5 | 2.5 | 2.5 | P1 | S1 | S2 |
| RPER71H682K2□□A03□ | X7R | 50 | 6800pF ±10% | 5.0 x 3.5 | 2.5 | 5.0 | K1 | M1 | M2 |
| RPER71H103K2□□A03□ | X7R | 50 | 10000pF ±10% | 5.0 x 3.5 | 2.5 | 2.5 | P1 | S1 | S2 |
| RPER71H103K2□□A03□ | X7R | 50 | 10000pF ±10% | 5.0 x 3.5 | 2.5 | 5.0 | K1 | M1 | M2 |
| RPER71H153K2□□A03□ | X7R | 50 | 15000pF ±10% | 5.0 x 3.5 | 2.5 | 2.5 | P1 | S1 | S2 |
| RPER71H153K2□□A03□ | X7R | 50 | 15000pF ±10% | 5.0 x 3.5 | 2.5 | 5.0 | K1 | M1 | M2 |
| RPER71H223K2□□A03□ | X7R | 50 | 22000pF ±10% | 5.0 x 3.5 | 2.5 | 2.5 | P1 | S1 | S2 |
| RPER71H223K2□□A03□ | X7R | 50 | 22000pF ±10% | 5.0 x 3.5 | 2.5 | 5.0 | K1 | M1 | M2 |
| RPER71H333K2□□A03□ | X7R | 50 | 33000pF ±10% | 5.0 x 3.5 | 3.15 | 2.5 | P1 | S1 | S2 |
| RPER71H333K2□□A03□ | X7R | 50 | 33000pF ±10% | 5.0 x 3.5 | 3.15 | 5.0 | K1 | M1 | M2 |
| RPER71H473K2□□A03□ | X7R | 50 | 47000pF ±10% | 5.0 x 3.5 | 3.15 | 2.5 | P1 | S1 | S2 |
| RPER71H473K2□□A03□ | X7R | 50 | 47000pF ±10% | 5.0 x 3.5 | 3.15 | 5.0 | K1 | M1 | M2 |
| RPER71H683K2□□A03□ | X7R | 50 | 68000pF ±10% | 5.0 x 3.5 | 3.15 | 2.5 | P1 | S1 | S2 |
| RPER71H683K2□□A03□ | X7R | 50 | 68000pF ±10% | 5.0 x 3.5 | 3.15 | 5.0 | K1 | M1 | M2 |
| RPER71H104K2□□A03□ | X7R | 50 | 0.10μF ±10% | 5.0 x 3.5 | 3.15 | 2.5 | P1 | S1 | S2 |
| RPER71H104K2□□A03□ | X7R | 50 | 0.10μF ±10% | 5.0 x 3.5 | 3.15 | 5.0 | K1 | M1 | M2 |
| RPER71H154K2□□C03□ | X7R | 50 | 0.15μF ±10% | 5.0 x 3.5 | 3.15 | 2.5 | P1 | S1 | S2 |
| RPER71H154K2□□C03□ | X7R | 50 | 0.15μF ±10% | 5.0 x 3.5 | 3.15 | 5.0 | K1 | M1 | M2 |
| RPER71H224K2□□C03□ | X7R | 50 | 0.22μF ±10% | 5.0 x 3.5 | 3.15 | 2.5 | P1 | S1 | S2 |
| RPER71H224K2□□C03□ | X7R | 50 | 0.22μF ±10% | 5.0 x 3.5 | 3.15 | 5.0 | K1 | M1 | M2 |
| RPER71H334K2□□C03□ | X7R | 50 | 0.33μF ±10% | 5.0 x 3.5 | 2.5 | 2.5 | P1 | S1 | S2 |
| RPER71H334K2□□C03□ | X7R | 50 | 0.33μF ±10% | 5.0 x 3.5 | 2.5 | 5.0 | K1 | M1 | M2 |
| RPER71H474K2□□C03□ | X7R | 50 | 0.47μF ±10% | 5.0 x 3.5 | 3.15 | 2.5 | P1 | S1 | S2 |
| RPER71H474K2□□C03□ | X7R | 50 | 0.47μF ±10% | 5.0 x 3.5 | 3.15 | 5.0 | K1 | M1 | M2 |
| RPER71H684K3□□C03□ | X7R | 50 | 0.68μF ±10% | 5.0 x 4.5 | 3.15 | 2.5 | P1 | S1 | S2 |
| RPER71H684K3□□C03□ | X7R | 50 | 0.68μF ±10% | 5.0 x 4.5 | 3.15 | 5.0 | K1 | M1 | M2 |
| RPER71H105K3□□C07□ | X7R | 50 | 1.0μF ±10% | 5.0 x 4.5 | 3.15 | 2.5 | P1 | S1 | S2 |
| RPER71H105K3□□C07□ | X7R | 50 | 1.0μF ±10% | 5.0 x 4.5 | 3.15 | 5.0 | K1 | M1 | M2 |
| RPER71H155K8□□C03□ | X7R | 50 | 1.5μF ±10% | 7.5 x 5.5 | 4.0 | 5.0 | K1 | M1 | M2 |
| RPER71H225K8□□C03□ | X7R | 50 | 2.2μF ±10% | 7.5 x 5.5 | 4.0 | 5.0 | K1 | M1 | M2 |
| RPER71H335K5□□C03□ | X7R | 50 | 3.3μF ±10% | 7.5 x 7.5 | 5.0 | 5.0 | B1 | E1 | E2 |

Continued on the following page.

Continued from the preceding page.

| Part Number | Temp. Char. | Rated Voltage (Vdc) | Capacitance | Dimensions LxW (mm) | Dimension T (mm) | Lead Space F (mm) | Lead Style Code Bulk | Lead Style Code Taping (1) | Lead Style Code Taping (2) |
|--------------------|-------------|---------------------|--------------|---------------------|------------------|-------------------|----------------------|----------------------------|----------------------------|
| RPER71H475K5□□C03□ | X7R | 50 | 4.7μF ±10% | 7.5 x 7.5 | 4.0 | 5.0 | B1 | E1 | E2 |
| RPER72A221K2□□B03□ | X7R | 100 | 220pF ±10% | 5.0 x 3.5 | 2.5 | 2.5 | P1 | S1 | S2 |
| RPER72A221K2□□B03□ | X7R | 100 | 220pF ±10% | 5.0 x 3.5 | 2.5 | 5.0 | K1 | M1 | M2 |
| RPER72A331K2□□B03□ | X7R | 100 | 330pF ±10% | 5.0 x 3.5 | 2.5 | 2.5 | P1 | S1 | S2 |
| RPER72A331K2□□B03□ | X7R | 100 | 330pF ±10% | 5.0 x 3.5 | 2.5 | 5.0 | K1 | M1 | M2 |
| RPER72A471K2□□B03□ | X7R | 100 | 470pF ±10% | 5.0 x 3.5 | 2.5 | 2.5 | P1 | S1 | S2 |
| RPER72A471K2□□B03□ | X7R | 100 | 470pF ±10% | 5.0 x 3.5 | 2.5 | 5.0 | K1 | M1 | M2 |
| RPER72A681K2□□B03□ | X7R | 100 | 680pF ±10% | 5.0 x 3.5 | 2.5 | 2.5 | P1 | S1 | S2 |
| RPER72A681K2□□B03□ | X7R | 100 | 680pF ±10% | 5.0 x 3.5 | 2.5 | 5.0 | K1 | M1 | M2 |
| RPER72A102K2□□A03□ | X7R | 100 | 1000pF ±10% | 5.0 x 3.5 | 2.5 | 2.5 | P1 | S1 | S2 |
| RPER72A102K2□□A03□ | X7R | 100 | 1000pF ±10% | 5.0 x 3.5 | 2.5 | 5.0 | K1 | M1 | M2 |
| RPER72A152K2□□A03□ | X7R | 100 | 1500pF ±10% | 5.0 x 3.5 | 2.5 | 2.5 | P1 | S1 | S2 |
| RPER72A152K2□□A03□ | X7R | 100 | 1500pF ±10% | 5.0 x 3.5 | 2.5 | 5.0 | K1 | M1 | M2 |
| RPER72A222K2□□A03□ | X7R | 100 | 2200pF ±10% | 5.0 x 3.5 | 2.5 | 2.5 | P1 | S1 | S2 |
| RPER72A222K2□□A03□ | X7R | 100 | 2200pF ±10% | 5.0 x 3.5 | 2.5 | 5.0 | K1 | M1 | M2 |
| RPER72A332K2□□A03□ | X7R | 100 | 3300pF ±10% | 5.0 x 3.5 | 2.5 | 2.5 | P1 | S1 | S2 |
| RPER72A332K2□□A03□ | X7R | 100 | 3300pF ±10% | 5.0 x 3.5 | 2.5 | 5.0 | K1 | M1 | M2 |
| RPER72A472K2□□A03□ | X7R | 100 | 4700pF ±10% | 5.0 x 3.5 | 2.5 | 2.5 | P1 | S1 | S2 |
| RPER72A472K2□□A03□ | X7R | 100 | 4700pF ±10% | 5.0 x 3.5 | 2.5 | 5.0 | K1 | M1 | M2 |
| RPER72A682K2□□A03□ | X7R | 100 | 6800pF ±10% | 5.0 x 3.5 | 2.5 | 2.5 | P1 | S1 | S2 |
| RPER72A682K2□□A03□ | X7R | 100 | 6800pF ±10% | 5.0 x 3.5 | 2.5 | 5.0 | K1 | M1 | M2 |
| RPER72A103K2□□A03□ | X7R | 100 | 10000pF ±10% | 5.0 x 3.5 | 3.15 | 2.5 | P1 | S1 | S2 |
| RPER72A103K2□□A03□ | X7R | 100 | 10000pF ±10% | 5.0 x 3.5 | 3.15 | 5.0 | K1 | M1 | M2 |
| RPER72A153K2□□A03□ | X7R | 100 | 15000pF ±10% | 5.0 x 3.5 | 3.15 | 2.5 | P1 | S1 | S2 |
| RPER72A153K2□□A03□ | X7R | 100 | 15000pF ±10% | 5.0 x 3.5 | 3.15 | 5.0 | K1 | M1 | M2 |
| RPER72A223K2□□A03□ | X7R | 100 | 22000pF ±10% | 5.0 x 3.5 | 3.15 | 2.5 | P1 | S1 | S2 |
| RPER72A223K2□□A03□ | X7R | 100 | 22000pF ±10% | 5.0 x 3.5 | 3.15 | 5.0 | K1 | M1 | M2 |
| RPER72A333K2□□C03□ | X7R | 100 | 33000pF ±10% | 5.0 x 3.5 | 3.15 | 2.5 | P1 | S1 | S2 |
| RPER72A333K2□□C03□ | X7R | 100 | 33000pF ±10% | 5.0 x 3.5 | 3.15 | 5.0 | K1 | M1 | M2 |
| RPER72A473K2□□C03□ | X7R | 100 | 47000pF ±10% | 5.0 x 3.5 | 3.15 | 2.5 | P1 | S1 | S2 |
| RPER72A473K2□□C03□ | X7R | 100 | 47000pF ±10% | 5.0 x 3.5 | 3.15 | 5.0 | K1 | M1 | M2 |
| RPER72A683K3□□C07□ | X7R | 100 | 68000pF ±10% | 5.0 x 4.5 | 3.15 | 2.5 | P1 | S1 | S2 |
| RPER72A683K3□□C07□ | X7R | 100 | 68000pF ±10% | 5.0 x 4.5 | 3.15 | 5.0 | K1 | M1 | M2 |
| RPER72A104K3□□C07□ | X7R | 100 | 0.10μF ±10% | 5.0 x 4.5 | 3.15 | 2.5 | P1 | S1 | S2 |
| RPER72A104K3□□C07□ | X7R | 100 | 0.10μF ±10% | 5.0 x 4.5 | 3.15 | 5.0 | K1 | M1 | M2 |
| RPER72A154K8□□C03□ | X7R | 100 | 0.15μF ±10% | 7.5 x 5.5 | 4.0 | 5.0 | K1 | M1 | M2 |
| RPER72A224K8□□C03□ | X7R | 100 | 0.22μF ±10% | 7.5 x 5.5 | 4.0 | 5.0 | K1 | M1 | M2 |
| RPER72A334K5□□C03□ | X7R | 100 | 0.33μF ±10% | 7.5 x 7.5 | 4.0 | 5.0 | B1 | E1 | E2 |
| RPER72A474K8□□C03□ | X7R | 100 | 0.47μF ±10% | 7.5 x 5.5 | 4.0 | 5.0 | K1 | M1 | M2 |
| RPER72A684K6□□F14□ | X7R | 100 | 0.68μF ±10% | 10.0 x 10.0 | 4.0 | 5.0 | B1 | E1 | E2 |
| RPER72A105K5□□C03□ | X7R | 100 | 1.0μF ±10% | 7.5 x 7.5 | 4.0 | 5.0 | B1 | E1 | E2 |
| RPER72A155K7□□F03□ | X7R | 100 | 1.5μF ±10% | 12.5 x 12.5 | 5.0 | 10.0 | C1 | - | - |
| RPER72A225K7□□F03□ | X7R | 100 | 2.2μF ±10% | 12.5 x 12.5 | 5.0 | 10.0 | C1 | - | - |

Two blank columns are filled with the lead style code. Please refer to the 3 columns on the right for the appropriate code.
 The last blank column is filled with the packaging code. (B: bulk, A: ammo pack)

High Dielectric Constant Type, Y5V Characteristics

| Part Number | Temp. Char. | Rated Voltage (Vdc) | Capacitance | Dimensions LxW (mm) | Dimension T (mm) | Lead Space F (mm) | Lead Style Code Bulk | Lead Style Code Taping (1) | Lead Style Code Taping (2) |
|--------------------|-------------|---------------------|-----------------|---------------------|------------------|-------------------|----------------------|----------------------------|----------------------------|
| RPEF51H102Z2□□A03□ | Y5V | 50 | 1000pF +80/-20% | 5.0 x 3.5 | 2.5 | 2.5 | P1 | S1 | S2 |
| RPEF51H102Z2□□A03□ | Y5V | 50 | 1000pF +80/-20% | 5.0 x 3.5 | 2.5 | 5.0 | K1 | M1 | M2 |
| RPEF51H222Z2□□A03□ | Y5V | 50 | 2200pF +80/-20% | 5.0 x 3.5 | 2.5 | 2.5 | P1 | S1 | S2 |
| RPEF51H222Z2□□A03□ | Y5V | 50 | 2200pF +80/-20% | 5.0 x 3.5 | 2.5 | 5.0 | K1 | M1 | M2 |
| RPEF51H472Z2□□A03□ | Y5V | 50 | 4700pF +80/-20% | 5.0 x 3.5 | 2.5 | 2.5 | P1 | S1 | S2 |
| RPEF51H472Z2□□A03□ | Y5V | 50 | 4700pF +80/-20% | 5.0 x 3.5 | 2.5 | 5.0 | K1 | M1 | M2 |

Continued on the following page. ↗

Continued from the preceding page.

| Part Number | Temp. Char. | Rated Voltage (Vdc) | Capacitance | Dimensions LxW (mm) | Dimension T (mm) | Lead Space F (mm) | Lead Style Code Bulk | Lead Style Code Taping (1) | Lead Style Code Taping (2) |
|--------------------|-------------|---------------------|------------------|---------------------|------------------|-------------------|----------------------|----------------------------|----------------------------|
| RPEF51H103Z2□□A03□ | Y5V | 50 | 10000pF +80/-20% | 5.0 x 3.5 | 2.5 | 2.5 | P1 | S1 | S2 |
| RPEF51H103Z2□□A03□ | Y5V | 50 | 10000pF +80/-20% | 5.0 x 3.5 | 2.5 | 5.0 | K1 | M1 | M2 |
| RPEF51H223Z2□□A03□ | Y5V | 50 | 22000pF +80/-20% | 5.0 x 3.5 | 2.5 | 2.5 | P1 | S1 | S2 |
| RPEF51H223Z2□□A03□ | Y5V | 50 | 22000pF +80/-20% | 5.0 x 3.5 | 2.5 | 5.0 | K1 | M1 | M2 |
| RPEF51H473Z2□□A03□ | Y5V | 50 | 47000pF +80/-20% | 5.0 x 3.5 | 2.5 | 2.5 | P1 | S1 | S2 |
| RPEF51H473Z2□□A03□ | Y5V | 50 | 47000pF +80/-20% | 5.0 x 3.5 | 2.5 | 5.0 | K1 | M1 | M2 |
| RPEF51H104Z2□□A03□ | Y5V | 50 | 0.10μF +80/-20% | 5.0 x 3.5 | 2.5 | 2.5 | P1 | S1 | S2 |
| RPEF51H104Z2□□A03□ | Y5V | 50 | 0.10μF +80/-20% | 5.0 x 3.5 | 2.5 | 5.0 | K1 | M1 | M2 |
| RPEF51H224Z2□□A03□ | Y5V | 50 | 0.22μF +80/-20% | 5.0 x 3.5 | 3.15 | 2.5 | P1 | S1 | S2 |
| RPEF51H224Z2□□A03□ | Y5V | 50 | 0.22μF +80/-20% | 5.0 x 3.5 | 3.15 | 5.0 | K1 | M1 | M2 |
| RPEF51H474Z2□□C03□ | Y5V | 50 | 0.47μF +80/-20% | 5.0 x 3.5 | 3.15 | 2.5 | P1 | S1 | S2 |
| RPEF51H474Z2□□C03□ | Y5V | 50 | 0.47μF +80/-20% | 5.0 x 3.5 | 3.15 | 5.0 | K1 | M1 | M2 |

Two blank columns are filled with the lead style code. Please refer to the 3 columns on the right for the appropriate code.

The last blank column is filled with the packaging code. (B: bulk, A: ammo pack)

Specifications and Test Methods

| No. | Item | | Specifications | | Test Method | | | | | | | | | |
|------------------|---|---|---|---|---|------------------|------------------|------------------|-----------|----------------|----------------|---------|----------------------|-------------------------|
| | | | Temperature Compensating Type | High Dielectric Constant Type | | | | | | | | | | |
| 1 | Operating Temperature Range | | -55 to +125°C | Char. X7R : -55 to +125°C Char. Y5V : -30 to +85°C | - | | | | | | | | | |
| 2 | Rated Voltage | | See previous pages | | The rated voltage is defined as the maximum voltage that may be applied continuously to the capacitor. When AC voltage is superimposed on DC voltage, V_{P-P} or V_{0-P} , whichever is larger, should be maintained within the rated voltage range. | | | | | | | | | |
| 3 | Appearance | | No defects or abnormalities | | Visual inspection | | | | | | | | | |
| 4 | Dimension and Marking | | See previous pages | | Visual inspection, Vernier Caliper | | | | | | | | | |
| 5 | Dielectric Strength | Between Terminals | No defects or abnormalities | | The capacitors should not be damaged when DC voltages of 300%* of the rated voltage are applied between the terminals for 1 to 5 sec. (Charge/Discharge current \leq 50mA) *250% for char. X7R, Y5V The capacitor is placed in a container with metal balls of 1mm diameter so that each terminal, short-circuited, is kept approximately 2mm from the balls as shown in the figure, and 250% of the rated DC voltage is impressed for 1 to 5 sec. between capacitor terminals and metal balls. (Charge/Discharge current \leq 50mA) | | | | | | | | | |
| | | Body Insulation | No defects or abnormalities | | | | | | | | | | | |
| 6 | Insulation Resistance | Between Terminals | $C \leq 0.047\mu\text{F}$: 10,000M Ω min. $C > 0.047\mu\text{F}$: 500M $\Omega \cdot \mu\text{F}$ min. C : Nominal capacitance | | The insulation resistance should be measured with a DC voltage not exceeding the rated voltage at normal temperature and humidity and within 2 min. of charging. (Charge/Discharge current \leq 50mA) | | | | | | | | | |
| 7 | Capacitance | | Within the specified tolerance | | The capacitance, Q/D.F. should be measured at 25°C at the frequency and voltage shown in the table. | | | | | | | | | |
| 8 | Q/Dissipation Factor (D.F.) | | 30pF min. : $Q \geq 1,000$ 30pF max. : $Q \geq 400+20C$ C : Nominal capacitance (pF) | Char. X7R : 0.025 max. Char. Y5V : 0.05 max. | <table border="1"> <thead> <tr> <th>Capacitance Item</th> <th>1000pF and below</th> <th>more than 1000pF</th> </tr> </thead> <tbody> <tr> <td>Frequency</td> <td>1\pm0.1MHz</td> <td>1\pm0.1kHz</td> </tr> <tr> <td>Voltage</td> <td>AC0.5 to 5V (r.m.s.)</td> <td>AC1\pm0.2V (r.m.s.)</td> </tr> </tbody> </table> | Capacitance Item | 1000pF and below | more than 1000pF | Frequency | 1 \pm 0.1MHz | 1 \pm 0.1kHz | Voltage | AC0.5 to 5V (r.m.s.) | AC1 \pm 0.2V (r.m.s.) |
| Capacitance Item | 1000pF and below | more than 1000pF | | | | | | | | | | | | |
| Frequency | 1 \pm 0.1MHz | 1 \pm 0.1kHz | | | | | | | | | | | | |
| Voltage | AC0.5 to 5V (r.m.s.) | AC1 \pm 0.2V (r.m.s.) | | | | | | | | | | | | |
| 9 | Capacitance Temperature Characteristics | Capacitance Change | Within the specified tolerance (Table A on last column) | Within the specified tolerance (Table B on last column) | The capacitance change should be measured after 5 min. at each specified temperature stage. (1) Temperature Compensating Type The temperature coefficient is determined using the capacitance measured in step 3 as a reference. When cycling the temperature sequentially from step 1 through 5 (-55 to +125°C) the capacitance should be within the specified tolerance for the temperature coefficient and capacitance change as shown in Table A. The capacitance drift is calculated by dividing the differences between the maximum and minimum measured values in step 1, 3 and 5 by the cap. value in step 3. | | | | | | | | | |
| | | Temperature Coefficient | Within the specified tolerance (Table A on last column) | | | | | | | | | | | |
| | Capacitance Drift | Within $\pm 0.2\%$ or $\pm 0.05\text{pF}$, whichever is larger | | | | | | | | | | | | |
| | | | | | (2) High Dielectric Constant Type The ranges of capacitance change compared with the 25°C value over the temperature ranges as shown in Table B should be within the specified ranges. | | | | | | | | | |

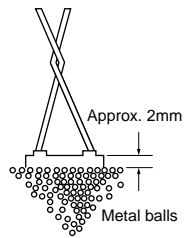

Continued on the following page.

Specifications and Test Methods

Continued from the preceding page.

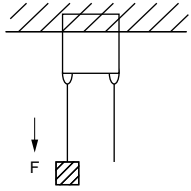
| No. | Item | Specifications | | Test Method | |
|-----|---------------------------------|---|--|--|--|
| | | Temperature Compensating Type | High Dielectric Constant Type | | |
| 10 | Terminal Strength | Tensile Strength | Termination not to be broken or loosened | | As in the figure, fix the capacitor body, apply the force gradually to each lead in the radial direction of the capacitor until reaching 10N and then keep the force applied for 10±1 sec.  |
| | | Bending Strength | Termination not to be broken or loosened | | |
| 11 | Vibration Resistance | Appearance | No defects or abnormalities | | The capacitor is soldered securely to a supporting terminal and a 10 to 55Hz vibration of 1.5mm peak-peak amplitude is applied for 6 hrs. total, 2 hrs. in each mutually perpendicular direction. Allow 1 min. to cycle the frequency from 10Hz to 55Hz and the converse. |
| | | Capacitance | Within the specified tolerance | | |
| | | Q/D.F. | 30pF min. : $Q \geq 1,000$ 30pF max. : $Q \geq 400+20C$ C : Nominal capacitance (pF) | Char. X7R : 0.025 max. Char. Y5V : 0.05 max. | |
| 12 | Solderability of Leads | Lead wire should be soldered with uniform coating on the axial direction over 3/4 of the circumferential direction. | | The terminal of a capacitor is dipped into a 25% ethanol (JIS-K-8101) solution of rosin (JIS-K-5902) and then into molten solder for 2±0.5 sec. In both cases the depth of dipping is up to about 1.5mm to 2mm from the terminal body. Temp. of solder: 245±5°C Lead Free Solder (Sn-3.0Ag-0.5Cu) 235±5°C H60A or H63A Eutectic Solder | |
| 13 | Resistance to Soldering Heat | Appearance | No defects or abnormalities | | The lead wire is immersed in the melted solder 1.5mm to 2mm from the main body at 350±10°C for 3.5±0.5 sec. The specified items are measured after 24±2 hrs. (temperature compensating type) or 48±4 hrs. (high dielectric type). • Initial measurement for high dielectric constant type The capacitors are heat treated for 1 hr. at 150±10°C, allowed to set at room temperature for 48±4 hrs., and given an initial measurement. |
| | | Capacitance Change | Within ±2.5% or ±0.25pF (whichever is larger) | Char. X7R : Within ±7.5% Char. Y5V : Within ±20% | |
| | | Dielectric Strength (Between Terminals) | No defects | | |
| 14 | Temperature and Immersion Cycle | Appearance | No defects or abnormalities | | First, repeat the following temperature/time cycle 5 times: >> lowest operating temperature ±3°C/30±3 min. >> ordinary temperature/3 min. max. >> highest operating temperature ±3°C/30±3 min. >> ordinary temperature/3 min. max. Next, repeat twice the successive cycles of immersion, each cycle consisting of immersion in a fresh water at 65±3°C for 15 min. and immersion in a saturated aqueous solution of salt at 0±3°C for 15 min. The capacitor is then promptly washed in running water, dried with a drying cloth, and allowed to sit at room temperature for 24±2 hrs. (temperature compensating type) or 48±4 hrs. (high dielectric type). • Initial measurement for high dielectric constant type The capacitors are heat treated for 1 hr. at 150±10°C, allowed to sit at room temperature for 48±4 hrs., and given an initial measurement. |
| | | Capacitance Change | Within ±5% or ±0.5pF (whichever is larger) | Char. X7R : Within ±12.5% Char. Y5V : Within ±30% | |
| | | Q/D.F. | 30pF min. : $Q \geq 350$ 10pF to 30pF : $Q \geq 275+5C/2$ 10pF max. : $Q \geq 200+10C$ C : Nominal capacitance (pF) | Char. X7R : 0.05 max. Char. Y5V : 0.075 max. | |
| | | Insulation Resistance | 1,000MΩ or 50MΩ • μF min. (whichever is smaller) | | |
| | | Dielectric Strength (Between Terminals) | No defects or abnormalities | | |

Continued on the following page. 

Specifications and Test Methods

Continued from the preceding page.

| No. | Item | Specifications | | Test Method | |
|-----|-------------------------|-------------------------------|--|--|---|
| | | Temperature Compensating Type | High Dielectric Constant Type | | |
| 15 | Humidity (Steady State) | Appearance | No defects or abnormalities | | Set the capacitor for 500 $\pm 24_0$ hrs. at 40 $\pm 2^\circ$ C in 90 to 95% humidity. Remove and set for 24 ± 2 hrs. (temperature compensating type) and 48 ± 4 hrs. (high dielectric constant type) at room temperature, then measure. |
| | | Capacitance Change | Within $\pm 5\%$ or $\pm 0.5\text{pF}$ (whichever is larger) | Char. X7R : Within $\pm 12.5\%$ Char. Y5V : Within $\pm 30\%$ | |
| | | Q/D.F. | 30pF min. : $Q \geq 350$ 10pF to 30pF : $Q \geq 275+5C/2$ 10pF max. : $Q \geq 200+10C$ C : Nominal capacitance (pF) | Char. X7R : 0.05 max. Char. Y5V : 0.075 max. | |
| | | Insulation Resistance | 1,000M Ω or 50M Ω \cdot μF min. (whichever is smaller) | | |
| 16 | Humidity Load | Appearance | No defects or abnormalities | | Apply the rated voltage for 500 $\pm 24_0$ hrs. at 40 $\pm 2^\circ$ C and in 90 to 95% humidity. Remove and set for 24 ± 2 hrs. (temperature compensating type) and 48 ± 4 hrs. (high dielectric constant type) at room temperature, then measure. (Charge/Discharge current $\leq 50\text{mA}$) |
| | | Capacitance Change | Within $\pm 7.5\%$ or $\pm 0.75\text{pF}$ (whichever is larger) | Char. X7R : Within $\pm 12.5\%$ Char. Y5V : Within $\pm 30\%$ | |
| | | Q/D.F. | 30pF min. : $Q \geq 200$ 30pF max. : $Q \geq 100+10C/3$ C : Nominal capacitance (pF) | Char. X7R : 0.05 max. Char. Y5V : 0.075 max. | |
| | | Insulation Resistance | 500M Ω or 25M Ω \cdot μF min. (whichever is smaller) | | |
| 17 | High Temperature Load | Appearance | No defects or abnormalities | | Apply 200% of the rated voltage for 1000 $\pm 48_0$ hrs. at the maximum operating temperature. Remove and set for 24 ± 2 hrs. (temperature compensating type) and 48 ± 4 hrs. (high dielectric constant type) at room temperature, then measure. (Charge/Discharge current $\leq 50\text{mA}$) • Initial measurement for high dielectric constant type A voltage treatment should be given to the capacitor in which a DC voltage of 200% of the rated voltage is applied for 1 hr. at the maximum operating temperature $\pm 3^\circ\text{C}$. Then set for 48 ± 4 hrs. at room temperature and conduct initial measurement. |
| | | Capacitance Change | Within $\pm 3\%$ or $\pm 0.3\text{pF}$ (whichever is larger) | Char. X7R : Within $\pm 12.5\%$ Char. Y5V : Within $\pm 30\%$ | |
| | | Q/D.F. | 30pF min. : $Q \geq 350$ 10pF to 30pF : $Q \geq 275+5C/2$ 10pF max. : $Q \geq 200+10C$ C : Nominal capacitance (pF) | Char. X7R : 0.04 max. Char. Y5V : 0.075 max. | |
| | | Insulation Resistance | 1,000M Ω or 50M Ω \cdot μF min. (whichever is smaller) | | |
| 18 | Solvent Resistance | Appearance | No defects or abnormalities | | The capacitor should be fully immersed, unagitated, in reagent at 20 to 25 $^\circ\text{C}$ for 30 ± 5 sec. and then removed gently. Marking on the surface of the capacitor should immediately be visually examined. Reagent: • Isopropyl alcohol |
| | | Marking | Legible | | |

Table A

| Char. | Nominal Values (ppm/ $^\circ\text{C}$) *1 | Capacitance Change from 25 $^\circ\text{C}$ (%) | | | | | |
|------------|--|---|-------|----------------------|-------|----------------------|-------|
| | | -55 $^\circ\text{C}$ | | -30 $^\circ\text{C}$ | | -10 $^\circ\text{C}$ | |
| | | Max. | Min. | Max. | Min. | Max. | Min. |
| C0G | 0 \pm 30 | 0.58 | -0.24 | 0.40 | -0.17 | 0.25 | -0.11 |

*1: Nominal values denote the temperature coefficient within a range of 25 to 125 $^\circ\text{C}$

Table B

| Char. | Temp. Range | Reference Temp. | Cap. Change Rate |
|------------|------------------------------|---------------------|---------------------|
| X7R | -55 to +125 $^\circ\text{C}$ | 25 $^\circ\text{C}$ | Within $\pm 15\%$ |
| Y5V | -30 to + 85 $^\circ\text{C}$ | | Within $\pm 22_8\%$ |

Radial Lead Type Monolithic Ceramic Capacitors



RPE Series Small Size, Large Capacitance (DC50V)

■ Features

1. The RPE series capacitors have small dimensions, large capacitance, and a capacity volume ratio of 10 micro F/cm cubed, close to that of electrolytic capacitors. They do not have polarity.
2. Excellent frequency characteristics and due to their small internal inductance are suitable for high frequencies.
3. They are not coated with wax so there is no change in their exterior appearance due to the outflow of wax during soldering or solvent during cleansing.
4. They are highly nonflammable, having characteristics equivalent to the UL94V-0 standard.
5. We design capacitors in much more compact size than current RPE Series, having reduced the diameter by 70% max.



Dimensions code: 2/3
 Lead style code: K1

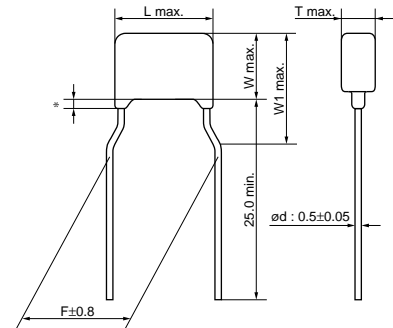

* Coating extension does not exceed the end of the lead bend.
 • Lead Wire : Solder Coated Copper Wire or Solder Coated CP Wire (in mm)



Dimensions code: W
 Lead style code: K1

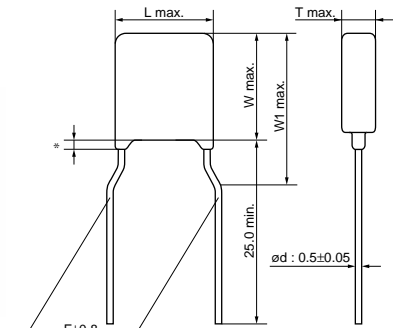

* Coating extension does not exceed the end of the lead bend.
 • Lead Wire : Solder Coated Copper Wire or Solder Coated CP Wire (in mm)





■ Dimensions

| Dimensions and Lead Style Code | Dimensions (mm) | | | | | |
|--------------------------------|-----------------|-----|------|-----------------------------|-----|-----|
| | L | W | W1 | T | F | d |
| 2K1/2M1 | 5.5 | 4.0 | 6.0 | Depends on Part Number List | 5.0 | 0.5 |
| 3K1/3M1 | 5.5 | 5.0 | 7.5 | | 5.0 | 0.5 |
| WK1/WM1 | 5.5 | 7.5 | 10.0 | | 5.0 | 0.5 |

Continued on the following page.

Continued from the preceding page.

Marking

| | | |
|-------------------------------|---------------|---|
| Dimensions Code | Rated Voltage | DC50V |
| | Temp. Char. | X7R |
| 2 | |  |
| 3 | |  |
| W | |  |
| Temperature Characteristics | | Marked with code (X7R char.: C) |
| Nominal Capacitance | | Marked with 3 figures |
| Capacitance Tolerance | | Marked with code |
| Rated Voltage | | Marked with code (DC50V: 5) |
| Manufacturer's Identification | | Marked with  |

High Dielectric Constant Type, X7R Characteristics

| Part Number | Temp. Char. | Rated Voltage (Vdc) | Capacitance (μF) | Dimensions LxW (mm) | Dimension T (mm) | Lead Space F (mm) | Lead Style Code Bulk | Lead Style Code Taping (1) | Lead Style Code Taping (2) |
|--------------------|-------------|---------------------|------------------|---------------------|------------------|-------------------|----------------------|----------------------------|----------------------------|
| RPER71H105K2□□C60□ | X7R | 50 | 1.0 ±10% | 5.5 x 4.0 | 3.15 | 5.0 | K1 | M1 | - |
| RPER71H155K2□□C60□ | X7R | 50 | 1.5 ±10% | 5.5 x 4.0 | 3.15 | 5.0 | K1 | M1 | - |
| RPER71H225K2□□C60□ | X7R | 50 | 2.2 ±10% | 5.5 x 4.0 | 3.15 | 5.0 | K1 | M1 | - |
| RPER71H335K3□□C60□ | X7R | 50 | 3.3 ±10% | 5.5 x 5.0 | 4.0 | 5.0 | K1 | M1 | - |
| RPER71H475K3□□C60□ | X7R | 50 | 4.7 ±10% | 5.5 x 5.0 | 4.0 | 5.0 | K1 | M1 | - |
| RPER71H106MW□□C60□ | X7R | 50 | 10 ±20% | 5.5 x 7.5 | 4.0 | 5.0 | K1 | M1 | - |

Two blank columns are filled with the lead style code. Please refer to the 3 columns on the right for the appropriate code.
 The last blank column is filled with the packaging code. (B: bulk, A: ammo pack)

Specifications and Test Methods

2

| No. | Item | Specifications | Test Method | | | | | | | | | | | | |
|------|---|--------------------------------------|--|------|------------------|---|------|---|-------|---|------|---|-------|---|------|
| 1 | Operating Temperature Range | -55 to +125°C | - | | | | | | | | | | | | |
| 2 | Appearance | No defects or abnormalities | Visual inspection | | | | | | | | | | | | |
| 3 | Dimension and Marking | See previous pages | Visual inspection, Vernier Caliper | | | | | | | | | | | | |
| 4 | Dielectric Strength | Between Terminals | No defects or abnormalities The capacitor should not be damaged when DC voltage of 250% of the rated voltage is applied between the terminations for 1 to 5 sec. (Charge/Discharge current ≤ 50mA) | | | | | | | | | | | | |
| | | Body Insulation | No defects or abnormalities The capacitor is placed in a container with metal balls of 1mm diameter so that each terminal, short-circuit, is kept approximately 2mm from the balls as shown in the figure, and 250% of the rated DC voltage is impressed for 1 to 5 sec. between capacitor terminals and metal balls. (Charge/Discharge current ≤ 50mA) | | | | | | | | | | | | |
| 5 | Insulation Resistance | Between Terminals 500MΩ · μF min. | The insulation resistance should be measured with a DC voltage not exceeding the rated voltage at normal temperature and humidity and within 2 min. of charging. (Charge/Discharge current ≤ 50mA) | | | | | | | | | | | | |
| 6 | Capacitance | Within the specified tolerance | The capacitance/D.F. should be measured at the frequency of 1±0.1kHz and a voltage of AC1±0.2V(r.m.s.) | | | | | | | | | | | | |
| 7 | Dissipation Factor (D.F.) | 0.025 max. | The capacitance change should be measured after 5 min. at each specified temperature stage. | | | | | | | | | | | | |
| 8 | Capacitance Temperature Characteristics | Within ±15% | <table border="1" style="margin-left: auto; margin-right: auto;"> <thead> <tr> <th style="width: 10%;">Step</th> <th style="width: 40%;">Temperature (°C)</th> </tr> </thead> <tbody> <tr><td>1</td><td>25±2</td></tr> <tr><td>2</td><td>-55±3</td></tr> <tr><td>3</td><td>25±2</td></tr> <tr><td>4</td><td>125±3</td></tr> <tr><td>5</td><td>25±2</td></tr> </tbody> </table> | Step | Temperature (°C) | 1 | 25±2 | 2 | -55±3 | 3 | 25±2 | 4 | 125±3 | 5 | 25±2 |
| Step | Temperature (°C) | | | | | | | | | | | | | | |
| 1 | 25±2 | | | | | | | | | | | | | | |
| 2 | -55±3 | | | | | | | | | | | | | | |
| 3 | 25±2 | | | | | | | | | | | | | | |
| 4 | 125±3 | | | | | | | | | | | | | | |
| 5 | 25±2 | | | | | | | | | | | | | | |
| 9 | Terminal Strength | Tensile Strength | Termination not to be broken or loosened As in the figure, fix the capacitor body, apply the force gradually to each lead in the radial direction of the capacitor until reaching 10N and then keep the force applied for 10±1 sec. | | | | | | | | | | | | |
| | | Bending Strength | Termination not to be broken or loosened Each lead wire should be subjected to a force of 2.5N and then bent 90° at the point of egress in one direction. Each wire is then returned to the original position and bent 90° in the opposite direction at the rate of one bend per 2 to 3 sec. | | | | | | | | | | | | |
| 10 | Vibration Resistance | Appearance | No defects or abnormalities | | | | | | | | | | | | |
| | | Capacitance | Within the specified tolerance | | | | | | | | | | | | |
| | | D.F. | 0.025 max. | | | | | | | | | | | | |

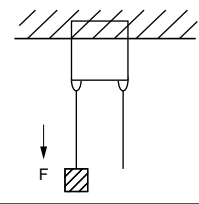
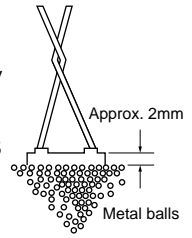

Continued on the following page.

Specifications and Test Methods

Continued from the preceding page.

| No. | Item | Specifications | Test Method | |
|-----|------------------------------|---|--|-----------------------------|
| 11 | Solderability of Leads | Lead wire should be soldered with uniform coating on the axial direction over 3/4 of the circumferential direction. | The terminal of a capacitor is dipped into a solution of ethanol (JIS-K-8101) and rosin (JIS-K-5902) (25% rosin in weight proportion) and then into molten solder (JIS-Z-3282) for 2±0.5 sec. In both cases the depth of dipping is up to about 1.5 to 2mm from the terminal body. Temp. of solder: 245±5°C Lead Free Solder (Sn-3.0Ag-0.5Cu) 235±5°C H60A or H63A Eutectic Solder | |
| 12 | Resistance to Soldering Heat | Appearance | No defects or abnormalities | |
| | | Capacitance Change | | Within ±7.5% |
| | | Dielectric Strength (Between Terminals) | | No defects |
| 13 | Temperature Cycle | Appearance | No defects or abnormalities | |
| | | Capacitance Change | | Within ±12.5% |
| | | D.F. | | 0.05 max. |
| | | Insulation Resistance | | 50MΩ · μF min. |
| | | Dielectric Strength (Between Terminals) | | No defects or abnormalities |
| 14 | Humidity (Steady State) | Appearance | No defects or abnormalities | |
| | | Capacitance Change | | Within ±12.5% |
| | | D.F. | | 0.05 max. |
| | | Insulation Resistance | | 50MΩ · μF min. |
| 15 | Humidity Load | Appearance | No defects or abnormalities | |
| | | Capacitance Change | | Within ±12.5% |
| | | D.F. | | 0.05 max. |
| | | Insulation Resistance | | 50MΩ · μF min. |
| 16 | High Temperature Load | Appearance | No defects or abnormalities | |
| | | Capacitance Change | | Within ±12.5% |
| | | D.F. | | 0.04 max. |
| | | Insulation Resistance | | 50MΩ · μF min. |
| 17 | Solvent Resistance | Appearance | No defects or abnormalities | |
| | | Marking | | Legible |

| Step | Temperature (°C) | Time (min) |
|------|------------------|------------|
| 1 | -55±3 | 30±3 |
| 2 | Room Temp. | 3 max. |
| 3 | 125±3 | 30±3 |
| 4 | Room Temp. | 3 max. |