

Chip Monolithic Ceramic Capacitors

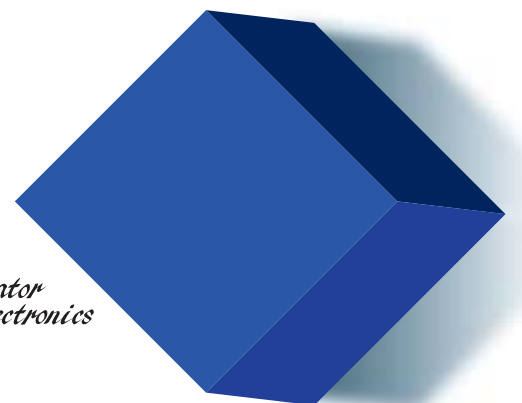
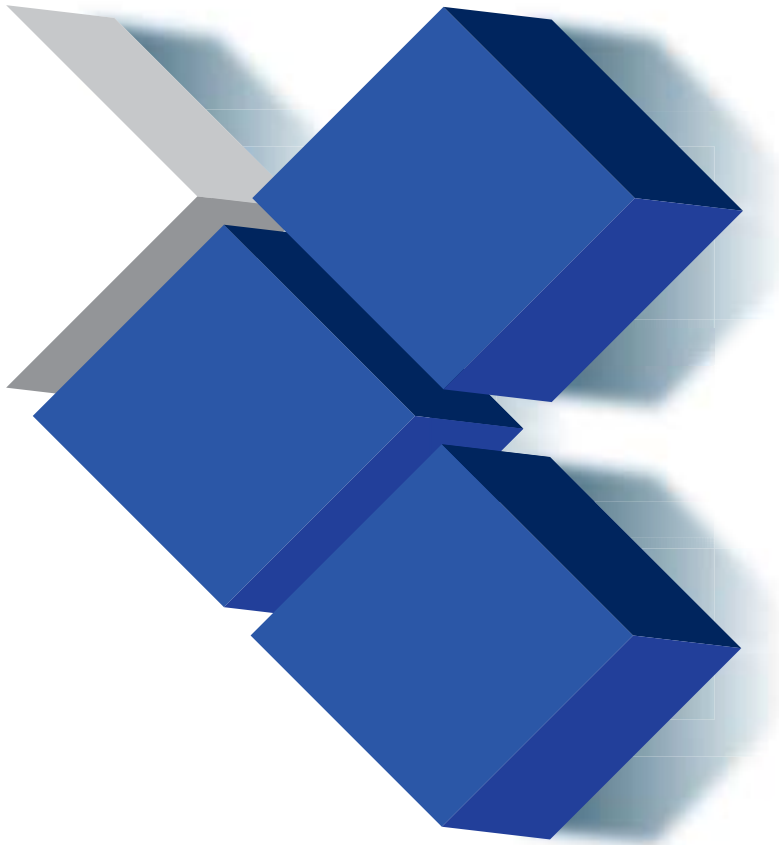

Murata
Manufacturing Co., Ltd.

*Innovator
in Electronics*

Explanation of Symbols in This Catalog

Ultra-compact

Lx W dimension: products of 0.6 x 0.3 mm or less

HiQ

Low dissipation for high frequency
 By devising ceramic materials and electrode materials, low dissipation is achieved in frequency bands of VHF, UHF and microwave or beyond.

Low ESL

Low inductance
 This capacitor is designed so that the parasitic inductance component (ESL) that the capacitor has on the high frequency side becomes lower.

Anti-noise

Product suitable for acoustic noise reduction and low distortion
 This product suppresses acoustic noise, which occurs when a ceramic capacitor is used, by devising the materials and configuration.

Deflecting crack

Product resistant to deflection cracking
 This capacitor is designed to prevent failures as much as possible by short mode caused by cracking when there is board deflection.

Soldering crack

Product with solder cracking suppression
 This capacitor is configured with metal terminals and leads connected to the chip. The metal terminals and leads relieve the stress from expansion and contraction of the solder, to suppress solder cracking.

Derating

Voltage and temperature derating recommended product
 This product is suitable when a voltage continuously applied to a capacitor in an operating circuit, is used below (derated) the rated voltage of the capacitor.
 This model guarantees the test conditions in the endurance test, at a rated voltage x 100% at the maximum operating temperature. A reliability assurance level equivalent to a common product can be secured, by using this product within the voltage and temperature derated conditions recommended in the figure below.

Recommended Conditions of the Derating Operating Voltage and Temperature

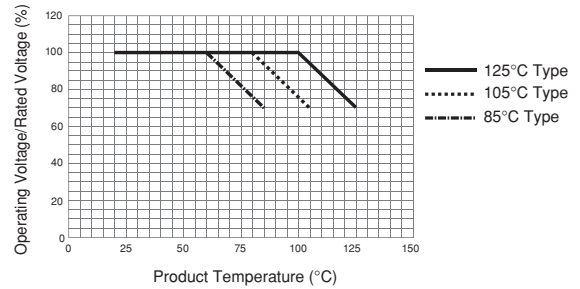

EU RoHS Compliant

- All the products in this catalog comply with EU RoHS.
- EU RoHS is "the European Directive 2011/65/EU on the Restriction of the Use of Certain Hazardous Substances in Electrical and Electronic Equipment."
- For more details, please refer to our website 'Murata's Approach for EU RoHS' (<http://www.murata.com/info/rohs.html>).



For General Purpose GRM Series Capacitance Table

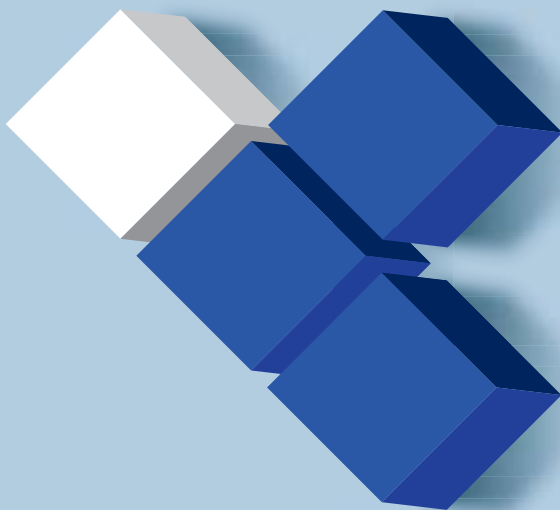

Contents

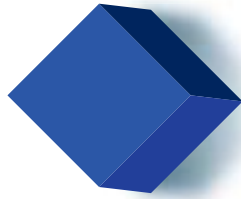

Product specifications are as of July 2012.

| | |
|-------------------------|-----|
| Selection Guide | p2 |
| Capacitance Table | p3 |
| Part Numbering | p15 |

Chip Monolithic Ceramic Capacitors

Cap. Table

| | | |
|--|-----|-----------------|
| For General Purpose GRM Series (Less than 250Vdc) | p21 | separate volume |
|--|-----|-----------------|

| | | |
|----------------------------------|-----|----|
| Capacitor Array GNM Series | p76 | p4 |
|----------------------------------|-----|----|

| | | |
|--------------------------------------|-----|----|
| Low ESL LLL/LLR/LLA/LLM Series | p79 | p5 |
|--------------------------------------|-----|----|

| | | |
|------------------------------|-----|----|
| High-Q Type GJM Series | p82 | p7 |
|------------------------------|-----|----|

| | | |
|---------------------------------|------|----|
| High Frequency GQM Series | p104 | p8 |
|---------------------------------|------|----|

| | | |
|---------------------------------------|------|----|
| Monolithic Microchip GMA Series | p113 | p9 |
|---------------------------------------|------|----|

| | | |
|------------------------------|------|-----|
| For Bonding GMD Series | p115 | p10 |
|------------------------------|------|-----|

| | |
|-----------------------|------|
| ⚠Caution/Notice | p118 |
|-----------------------|------|

Chip Monolithic Ceramic Capacitors (Medium Voltage)

Cap. Table

For General Purpose GRM (250Vdc min.)/GRJ/GR3 Series

| | | |
|--|------|-----------------|
| Temperature Compensating Type | | |
| GRM Series (250Vdc min.) | p136 | separate volume |
| High Dielectric Constant Type | | |
| GRM Series (250Vdc min.) | p143 | separate volume |
| Soft Termination Type GRJ Series | p148 | p11 |
| Large Capacitance and High Allowable | | |
| Ripple Current GR3 Series | p153 | p11 |

Only for Applications

| | | |
|---|------|-----|
| For LCD Backlight Inverter Circuit | | |
| GRM/DC3.15kV Series | p158 | p12 |
| For Information Devices GR4 Series | p161 | p12 |
| For Camera Flash Circuit GR7 Series | p165 | p12 |

AC250V Type (Which Meet Japanese Law)

| | | |
|------------------|------|-----|
| GA2 Series | p169 | p12 |
|------------------|------|-----|

Safety Standard Certified GA3 Series

| | | |
|--|------|-----|
| UL, IEC60384-14 Class X1/Y2 Type GC .. | p173 | p13 |
| IEC60384-14 Class Y2, X1/Y2 Type GF .. | p174 | p13 |
| IEC60384-14 Class Y3 Type GD | p176 | p13 |
| IEC60384-14 Class X2 Type GB | p177 | p13 |

| | |
|--|------|
| Reference Data (Typical Example) | p182 |
| Package | p185 |
| ⚠Caution/Notice | p188 |

Metal Terminal Monolithic Ceramic Capacitors

Cap. Table

For General Purpose KRM/KR3 Series

| | | |
|--------------------------------------|------|-----|
| High Capacitance for General Use | | |
| KRM Series | p200 | p14 |
| Large Capacitance and High Allowable | | |
| Ripple Current KR3 Series | p204 | p14 |

| | |
|-----------------------|------|
| Package | p208 |
| ⚠Caution/Notice | p210 |

| | |
|--------------------------------------|------|
| ISO 9001 Certifications | p215 |
| Introduction of WEB SimSurfing | p216 |
| EMICON-FUN! | p217 |
| Product Information | p218 |

Please check the MURATA home page (<http://www.murata.com/>) if you cannot find the part number in the catalog.

Selection Guide For Chip Monolithic Ceramic Capacitors

| | Function | Type | Series |
|---|--|---|--|
| Applications? | Decoupling, Smoothing | High Capacitance | GRM (X5R, X7R, Y5V etc.) 68pF–150μF |
| | | Array (2 or 4 Elements) | GNM 470pF–2.2μF |
| | Frequency Control/Tuning, Impedance Matching | Class 1 TC's | GRM (C0G) 0.1pF–0.1μF |
| | | | GRM (U2J etc.) |
| | High Speed Decoupling | Low Inductance (Reverse Geometry) | LLL 2200pF–10μF |
| | | Low Inductance (Controlled ESR) | LLR 1.0μF |
| | | Low Inductance (Multi-Termination) | LLA/LLM (From 1GHz) 0.01μF–4.7μF |
| | High Frequency | Low ESR, Ultra Small | GJM (500MHz to 10GHz) 0.1pF–47pF |
| | | Lowest ESR | GQM (500MHz to 10GHz) 0.1pF–100pF |
| | Optical Communications | Wire-Die-Bonding | GMA 100pF–0.47μF GMD 100pF–0.47μF |
| | 250Vdc min. High-Frequency Snubber | 250V/630V/1kV/2kV/3.15kV Low Dissipation | GRM (C0G, U2J) 10pF–47000pF |
| | 250Vdc min. LCD Backlight Inverter | 3.15kV Low Dissipation | GRM (C0G) 5pF–47pF |
| | 250Vdc min. Decoupling, Smoothing | 250V/630V/1kV High Capacitance | GRM (X7R) 220pF–1μF |
| | | 250V/630V/1kV Soft Termination | GRJ (X7R) 470pF–1μF |
| | | 250V/450V/630V Large Capacitance and High Allowable Ripple Current | GR3 (X7T) 10000pF–1μF |
| | 250Vdc min. For Camera Flash Circuit only | 350V High Capacitance | GR7 10000pF–47000pF |
| | 250Vdc min. For Information Devices only | 2kV High Capacitance | GR4 100pF–10000pF |
| | | Safety Standard Certified | Type GD 10pF–4700pF Type GF 10pF–4700pF |
| AC Lines Noise Removal | Safety Standard Certified | Type GC 100pF–330pF Type GF 470pF–4700pF Type GB 10000pF–56000pF | |
| | AC250V which meets Japanese Law | GA2 470pF–0.1μF | |
| Automotive (Powertrain, Safety Equipment) | High Capacitance | GCM (X7R etc.) 100pF–47μF | |
| | Class 1 TC's | GCM (C0G etc.) 1.0pF–56000pF | |
| 250Vdc min. for Automotive (Powertrain, Safety Equipment) | 250V/630V/1kV Low Dissipation | GCM (U2J) 10pF–47000pF | |
| | 250V/630V Soft Termination | GCJ (X7R) 1000pF–0.47μF | |

Capacitance Table

● Temperature Characteristics Table

| Temperature Characteristic Codes | | Temperature Characteristics | | | Operating Temperature Range | Capacitance Change Each Temperature (%) | | | | | |
|--------------------------------------|-----|-----------------------------|-----------------------|---------------------|-----------------------------|---|-------|-------|-------|-------|-------|
| | | | | | | -55°C | | -25°C | | -10°C | |
| | | Public STD Code | Reference Temperature | Temperature Range | | Capacitance Change or Temperature Coefficient | Max. | Min. | Max. | Min. | Max. |
| C0G | EIA | 25°C | 25 to 125°C | 0±30ppm/°C | -55 to 125°C | 0.58 | -0.24 | 0.4 | -0.17 | 0.25 | -0.11 |
| C0H | EIA | 25°C | 25 to 125°C | 0±60ppm/°C | -55 to 125°C | 0.87 | -0.48 | 0.59 | -0.33 | 0.38 | -0.21 |
| CK | JIS | 20°C | 20 to 125°C | 0±250ppm/°C | -55 to 125°C | 2.56 | -1.88 | 1.54 | -1.13 | 1.02 | -0.75 |
| CJ | JIS | 20°C | 20 to 125°C | 0±120ppm/°C | -55 to 125°C | 1.37 | -0.9 | 0.82 | -0.54 | 0.55 | -0.36 |
| CH | JIS | 20°C | 20 to 125°C | 0±60ppm/°C | -55 to 125°C | 0.82 | -0.45 | 0.49 | -0.27 | 0.33 | -0.18 |
| SL | JIS | 20°C | 20 to 85°C | +350 to -1000ppm/°C | -55 to 125°C | - | - | - | - | - | - |
| P2H | EIA | 25°C | 25 to 85°C | -150±60ppm/°C | -55 to 125°C | 2.33 | 0.72 | 1.61 | 0.5 | 1.02 | 0.32 |
| PK | JIS | 20°C | 20 to 85°C | -150±250ppm/°C | -25 to 85°C | - | - | 2.36 | -0.45 | 1.57 | -0.3 |
| PJ | JIS | 20°C | 20 to 85°C | -150±120ppm/°C | -25 to 85°C | - | - | 1.65 | 0.14 | 1.1 | 0.09 |
| PH | JIS | 20°C | 20 to 85°C | -150±60ppm/°C | -25 to 85°C | - | - | 1.32 | 0.41 | 0.88 | 0.27 |
| R2H | EIA | 25°C | 25 to 85°C | -220±60ppm/°C | -55 to 125°C | 3.02 | 1.28 | 2.08 | 0.88 | 1.32 | 0.56 |
| RK | JIS | 20°C | 20 to 85°C | -220±250ppm/°C | -25 to 85°C | - | - | 2.74 | -0.14 | 1.83 | -0.09 |
| RJ | JIS | 20°C | 20 to 85°C | -220±120ppm/°C | -25 to 85°C | - | - | 2.03 | 0.45 | 1.35 | 0.3 |
| RH | JIS | 20°C | 20 to 85°C | -220±60ppm/°C | -25 to 85°C | - | - | 1.7 | 0.72 | 1.13 | 0.48 |
| S2H | EIA | 25°C | 25 to 85°C | -330±60ppm/°C | -55 to 125°C | 4.09 | 2.16 | 2.81 | 1.49 | 1.79 | 0.95 |
| SK | JIS | 20°C | 20 to 85°C | -330±250ppm/°C | -25 to 85°C | - | - | 3.35 | 0.36 | 2.23 | 0.24 |
| SJ | JIS | 20°C | 20 to 85°C | -330±120ppm/°C | -25 to 85°C | - | - | 2.63 | 0.95 | 1.76 | 0.63 |
| SH | JIS | 20°C | 20 to 85°C | -330±60ppm/°C | -25 to 85°C | - | - | 2.3 | 1.22 | 1.54 | 0.81 |
| T2H | EIA | 25°C | 25 to 85°C | -470±60ppm/°C | -55 to 125°C | 5.46 | 3.28 | 3.75 | 2.26 | 2.39 | 1.44 |
| TK | JIS | 20°C | 20 to 85°C | -470±250ppm/°C | -25 to 85°C | - | - | 4.12 | 0.99 | 2.74 | 0.66 |
| TJ | JIS | 20°C | 20 to 85°C | -470±120ppm/°C | -25 to 85°C | - | - | 3.4 | 1.58 | 2.27 | 1.05 |
| TH | JIS | 20°C | 20 to 85°C | -470±60ppm/°C | -25 to 85°C | - | - | 3.07 | 1.85 | 2.05 | 1.23 |
| U2J | EIA | 25°C | 25 to 125°C | -750±120ppm/°C | -55 to 125°C | 8.78 | 5.04 | 6.04 | 3.47 | 3.84 | 2.21 |
| UK | JIS | 20°C | 20 to 85°C | -750±250ppm/°C | -25 to 85°C | - | - | 5.65 | 2.25 | 3.77 | 1.5 |
| UJ | JIS | 20°C | 20 to 85°C | -750±120ppm/°C | -25 to 85°C | - | - | 4.94 | 2.84 | 3.29 | 1.89 |
| X7R | EIA | 25°C | -55 to 125°C | ±15% | -55 to 125°C | - | - | - | - | - | - |
| X7S | EIA | 25°C | -55 to 125°C | ±22% | -55 to 125°C | - | - | - | - | - | - |
| X7T | EIA | 25°C | -55 to 125°C | +22%, -33% | -55 to 125°C | - | - | - | - | - | - |
| X7U | EIA | 25°C | -55 to 125°C | +22%, -56% | -55 to 125°C | - | - | - | - | - | - |
| R | JIS | 20°C | -55 to 125°C | ±15% | -55 to 125°C | - | - | - | - | - | - |
| X6S | EIA | 25°C | -55 to 105°C | ±22% | -55 to 105°C | - | - | - | - | - | - |
| X6T | EIA | 25°C | -55 to 105°C | +22%, -33% | -55 to 105°C | - | - | - | - | - | - |
| X5R | EIA | 25°C | -55 to 85°C | ±15% | -55 to 85°C | - | - | - | - | - | - |
| X5S | EIA | 25°C | -55 to 85°C | ±22% | -55 to 85°C | - | - | - | - | - | - |
| B | JIS | 20°C | -25 to 85°C | ±10% | -25 to 85°C | - | - | - | - | - | - |
| -: Murata Temperature Characteristic | | 25°C | -55 to 125°C | ±10% | -55 to 125°C | - | - | - | - | - | - |

■ GRM Series



For the Capacitance Table of General Purpose GRM Series, please review the inserted Capacitance Table of "Chip Monolithic Ceramic Capacitor and General Purpose GRM Series".

Capacitance Table

p00

Each number in the Part Number List refers to the page number printed at the bottom of the page.

■ GRM Series Temperature Compensating Type

p00

← Part Number List

JIS:

CK

CJ

CH

SL

PK

PJ

PH

RK

RJ

RH

SK

SJ

SH

TK

TJ

TH

UK

UJ

EIA:

C0G

P2H

R2H

S2H

T2H

U2J

| LxW (mm) | 0.4x0.2 | | | | 0.6x0.3 | | | | | | | | 1.0x0.5 | | | | | | | | | |
|---------------------|---------|-----|-----|-----|---------|-----|-----|-----|-----|-----|-----|-----|---------|-----|-----|-----|------|-----|-----|-----|-----|-----|
| T max. (mm) | 0.22 | | | | 0.33 | | | | | | | | 0.33 | | | | 0.55 | | | | | |
| Rated Voltage (Vdc) | 16 | | 10 | | 50 | | | 25 | | | | | 50 | | | | 50 | | | | | |
| Cap. / TC Code | C0G | CΔ | C0G | CH | C0G | CΔ | UΔ | R2H | RΔ | S2H | SΔ | T2H | TΔ | UJ | C0G | CΔ | C0G | CΔ | P2H | PΔ | R2H | RΔ |
| 0.1pF | | | | | p28 | p32 | | | | | | | | | p36 | p38 | p39 | p42 | | | | |
| 0.2pF | p22 | p25 | | | p28 | p32 | | | | | | | | | p36 | p38 | p39 | p42 | | | | |
| 0.5pF | p22 | p25 | | | p28 | p32 | | | | | | | | | p36 | p38 | p39 | p42 | | | | |
| 1.0pF | p22 | p25 | | | p28 | p32 | p35 | p35 | p35 | p35 | p36 | p36 | p36 | | p37 | p38 | p39 | p42 | p46 | p46 | p46 | p46 |
| 2.0pF | p22 | p25 | | | p29 | p32 | p35 | p35 | p35 | p36 | p36 | p36 | p36 | | p37 | p38 | p39 | p43 | p46 | p46 | p46 | p46 |
| 3.0pF | p22 | p25 | | | p29 | p32 | p35 | p35 | p35 | p36 | p36 | p36 | p36 | | p37 | p38 | p39 | p43 | p46 | p46 | p46 | p46 |
| 4.0pF | p23 | p26 | | | p29 | p33 | p35 | p35 | p35 | p36 | p36 | p36 | p36 | | p37 | p38 | p40 | p43 | p46 | p46 | p46 | p46 |
| 5.0pF | p23 | p26 | | | p30 | p33 | p35 | p35 | p35 | p36 | p36 | p36 | p36 | | p37 | p38 | p40 | p44 | p46 | p46 | p46 | p46 |
| 6.0pF | p23 | p26 | | | p30 | p33 | p35 | p35 | p35 | p36 | p36 | p36 | p36 | | p37 | p38 | p40 | p44 | p46 | p46 | p46 | p46 |
| 7.0pF | p24 | p27 | | | p30 | p34 | p35 | p35 | p35 | p36 | p36 | p36 | p36 | | p37 | p38 | p41 | p44 | p46 | p46 | p46 | p46 |
| 8.0pF | p24 | p27 | | | p31 | p34 | p35 | p35 | p35 | p36 | p36 | p36 | p36 | | p37 | p38 | p41 | p45 | p46 | p46 | p46 | p46 |
| 9.0pF | p24 | p28 | | | p31 | p34 | p35 | p35 | p35 | p36 | p36 | p36 | p36 | | p37 | p38 | p41 | p45 | p46 | p46 | p46 | p46 |
| 10pF | p25 | p28 | | | p31 | p35 | p35 | p35 | p35 | p36 | p36 | p36 | p36 | | p37 | p38 | p42 | p45 | p46 | p46 | p46 | p46 |
| 12pF | p25 | p28 | | | p31 | p35 | p35 | p35 | p35 | p36 | p36 | p36 | p36 | | p37 | p39 | p42 | p45 | p46 | p46 | p46 | p46 |
| 15pF | p25 | p28 | | | p31 | p35 | p35 | p35 | p35 | p36 | p36 | p36 | p36 | | p37 | p39 | p42 | p45 | p46 | p46 | p46 | p46 |
| 18pF | p25 | p28 | | | p31 | p35 | | p35 | p35 | p36 | p36 | p36 | p36 | p36 | p37 | p39 | p42 | p45 | p46 | p46 | p46 | p46 |
| 22pF | p25 | p28 | | | p31 | p35 | | p35 | p35 | p36 | p36 | p36 | p36 | p36 | p37 | p39 | p42 | p45 | p46 | p46 | p46 | p46 |
| 27pF | p25 | p28 | | | p31 | p35 | | p35 | p35 | p36 | p36 | p36 | p36 | p36 | p37 | p39 | p42 | p46 | p46 | p46 | p46 | p46 |
| 33pF | p25 | p28 | | | p31 | p35 | | p35 | p35 | p36 | p36 | p36 | p36 | p36 | p37 | p39 | p42 | p46 | | | p46 | p46 |
| 39pF | p25 | p28 | | | p32 | p35 | | p35 | p35 | p36 | p36 | p36 | p36 | p36 | p37 | p39 | p42 | p46 | | | | |
| 47pF | p25 | p28 | | | p32 | p35 | | p35 | p35 | p36 | p36 | p36 | p36 | p36 | p37 | p39 | p42 | p46 | | | | |
| 56pF | | | p28 | p28 | p32 | p35 | | p35 | p35 | p36 | p36 | p36 | p36 | p36 | p37 | p39 | p42 | p46 | | | | |
| 68pF | | | p28 | p28 | p32 | p35 | | p35 | p35 | p36 | p36 | p36 | p36 | p36 | p37 | p39 | p42 | p46 | | | | |
| 82pF | | | p28 | p28 | p32 | p35 | | p35 | p35 | p36 | p36 | p36 | p36 | p36 | p37 | p39 | p42 | p46 | | | | |
| 100pF | | | p28 | p28 | p32 | p35 | | p35 | p35 | p36 | p36 | p36 | p36 | p36 | p37 | p39 | p42 | p46 | | | | |
| 120pF | | | | | | | | | | | | | | | p37 | p39 | p42 | p46 | | | | |
| 150pF | | | | | | | | | | | | | | | p37 | p39 | p42 | p46 | | | | |
| 180pF | | | | | | | | | | | | | | | p38 | p39 | p42 | p46 | | | | |
| 220pF | | | | | | | | | | | | | | | p38 | p39 | p42 | p46 | | | | |
| 270pF | | | | | | | | | | | | | | | p38 | p39 | p42 | p46 | | | | |
| 330pF | | | | | | | | | | | | | | | p38 | p39 | p42 | p46 | | | | |
| 390pF | | | | | | | | | | | | | | | p38 | p39 | p42 | p46 | | | | |
| 470pF | | | | | | | | | | | | | | | p38 | p39 | p42 | p46 | | | | |
| 560pF | | | | | | | | | | | | | | | p38 | p39 | p42 | p46 | | | | |
| 680pF | | | | | | | | | | | | | | | p38 | p39 | p42 | p46 | | | | |
| 820pF | | | | | | | | | | | | | | | | | p42 | p46 | | | | |
| 1000pF | | | | | | | | | | | | | | | | | p42 | p46 | | | | |

The indication for every 0.1 pF has been omitted for less than 10 pF. Refer to the Part Number List for details.



Capacitance Table

p00

Each number in the Part Number List refers to the page number printed at the bottom of the page.

(→ ■ GRM Series Temperature Compensating Type)

p00

← Part Number List

JIS:

CK

CJ

CH

SL

PK

PJ

PH

RK

RJ

RH

SK

SJ

SH

TK

TJ

TH

UK

UJ

EIA:

C0G

P2H

R2H

S2H

T2H

U2J

| LxW (mm) | 1.0x0.5 | | | | | | | | | | 1.6x0.8 | | | | | | | | | | | | |
|----------------|---------|-----|-----|-----|-----|-----|-----|-----|-----|-----|---------|-----|-----|-----|-----|-----|-----|-----|-----|-----|-----|----|-----|
| | 0.55 | | | | | | | | | | 0.5 | | | | | 0.9 | | | | | | | |
| | 50 | | | | | 10 | | | | | 50 | | | 100 | | 50 | | | 10 | | | | |
| Cap. / TC Code | S2H | SΔ | T2H | TΔ | UΔ | SL | U2J | UJ | SL | U2J | UJ | SL | U2J | UJ | C0G | CΔ | C0G | CΔ | SL | U2J | UJ | SL | |
| 0.5pF | | | | | | | | | | | | | | | p48 | p51 | p55 | p58 | | | | | |
| 1.0pF | p46 | p47 | p47 | p47 | p47 | | | | | | | | | | p48 | p51 | p55 | p58 | | | | | |
| 2.0pF | p46 | p47 | p47 | p47 | p47 | | | | | | | | | | p48 | p52 | p55 | p58 | | | | | |
| 3.0pF | p46 | p47 | p47 | p47 | p47 | | | | | | | | | | p49 | p52 | p55 | p59 | | | | | |
| 4.0pF | p46 | p47 | p47 | p47 | p47 | | | | | | | | | | p49 | p52 | p55 | p59 | | | | | |
| 5.0pF | p46 | p47 | p47 | p47 | p47 | | | | | | | | | | p49 | p52 | p56 | p59 | | | | | |
| 6.0pF | p46 | p47 | p47 | p47 | p47 | | | | | | | | | | p49 | p53 | p56 | p59 | | | | | |
| 7.0pF | p47 | p47 | p47 | p47 | p47 | | | | | | | | | | p50 | p53 | p56 | p60 | | | | | |
| 8.0pF | p47 | p47 | p47 | p47 | p47 | | | | | | | | | | p50 | p54 | p57 | p60 | | | | | |
| 9.0pF | p47 | p47 | p47 | p47 | p47 | | | | | | | | | | p51 | p54 | p57 | p61 | | | | | |
| 10pF | p47 | p47 | p47 | p47 | p47 | | | | | | | | | | p51 | p54 | p58 | p61 | | | | | |
| 12pF | p47 | p47 | p47 | p47 | p47 | | | | | | | | | | p51 | p54 | p58 | p61 | | | | | |
| 15pF | p47 | p47 | p47 | p47 | p47 | | | | | | | | | | p51 | p54 | p58 | p61 | | | | | |
| 18pF | p47 | p47 | p47 | p47 | p47 | | | | | | | | | | p51 | p54 | p58 | p61 | | | | | |
| 22pF | p47 | p47 | p47 | p47 | p47 | | | | | | | | | | p51 | p54 | p58 | p61 | | | | | |
| 27pF | p47 | p47 | p47 | p47 | p47 | | | | | | | | | | p51 | p54 | p58 | p61 | | | | | |
| 33pF | p47 | p47 | p47 | p47 | p47 | | | | | | | | | | p51 | p54 | p58 | p61 | | | | | |
| 39pF | p47 | p47 | p47 | p47 | p47 | | | | | | | | | | p51 | p54 | p58 | p61 | | | | | |
| 47pF | | | p47 | p47 | p47 | | | | | | | | | | p51 | p54 | p58 | p61 | | | | | |
| 56pF | | | p47 | p47 | p47 | | | | | | | | | | p51 | p54 | p58 | p61 | | | | | |
| 68pF | | | p47 | p47 | p47 | | | | | | | | | | p51 | p54 | p58 | p61 | | | | | |
| 82pF | | | p47 | p47 | p47 | | | | | | | | | | p51 | p54 | p58 | p61 | | | | | |
| 100pF | | | p47 | p47 | p47 | | | | | | | | | | p51 | p54 | p58 | p61 | | | | | |
| 120pF | | | | | p47 | | | | | | | | | | p51 | p54 | p58 | p61 | | | | | |
| 150pF | | | | | p47 | | | | | | | | | | p51 | p54 | p58 | p61 | | | | | |
| 180pF | | | | | p47 | | | | | | | | | | p51 | p54 | p58 | p61 | | | | | |
| 220pF | | | | | | | | | | | | | | | p51 | p54 | p58 | p61 | | | | | |
| 270pF | | | | | | | | | | | | | | | p51 | p54 | p58 | p61 | | | | | |
| 330pF | | | | | | | | | | | | | | | p51 | p54 | p58 | p61 | | | | | |
| 390pF | | | | | | | | | | | | | | | p51 | p54 | p58 | p61 | | | | | |
| 470pF | | | | | | | | | | | | | | | p51 | p54 | p58 | p61 | | | | | |
| 560pF | | | | | | | | | | | | | | | p51 | p54 | p58 | p61 | | | | | |
| 680pF | | | | | | | | | | | | | | | p51 | p54 | p58 | p61 | | | | | |
| 820pF | | | | | | | | | | | | | | | p51 | p54 | p58 | p61 | | | | | |
| 1000pF | | | | | | | | | | | | | | | p51 | p54 | p58 | p61 | | | | | p61 |
| 1200pF | | | | | | p47 | p47 | p48 | | | | | | | p51 | p54 | p58 | p61 | p61 | p61 | p61 | | |
| 1500pF | | | | | | p47 | p47 | p48 | | | | | | | p51 | p55 | p58 | p61 | p61 | p61 | p61 | | |
| 1800pF | | | | | | p47 | p47 | p48 | | | | | | | | | p58 | p61 | p61 | p61 | p61 | | |
| 2200pF | | | | | | p47 | p48 | p48 | p48 | p48 | p48 | | | | | | p58 | p61 | p61 | p61 | p61 | | |
| 2700pF | | | | | | p47 | p48 | p48 | p48 | p48 | p48 | | | | | | p58 | p61 | p61 | p61 | p61 | | |
| 3300pF | | | | | | p47 | p48 | p48 | p48 | p48 | p48 | | | | | | p58 | p61 | p61 | p61 | p61 | | |
| 3900pF | | | | | | p47 | p48 | p48 | p48 | p48 | p48 | | | | | | p58 | p61 | p61 | p61 | p61 | | |
| 4700pF | | | | | | p47 | p48 | p48 | p48 | p48 | p48 | | | | | | | | p61 | p61 | p61 | | |
| 5600pF | | | | | | | | | | | | p48 | p48 | p48 | | | | | p61 | p61 | p62 | | |
| 6800pF | | | | | | | | | | | | p48 | p48 | p48 | | | | | p61 | p61 | p62 | | |
| 8200pF | | | | | | | | | | | | p48 | p48 | p48 | | | | | p61 | p61 | p62 | | |
| 10000pF | | | | | | | | | | | | p48 | p48 | p48 | | | | | p61 | p61 | p62 | | |
| 12000pF | | | | | | | | | | | | | | | | | | | | | | | p62 |
| 15000pF | | | | | | | | | | | | | | | | | | | | | | | p62 |
| 18000pF | | | | | | | | | | | | | | | | | | | | | | | p62 |
| 22000pF | | | | | | | | | | | | | | | | | | | | | | | p62 |

The indication for every 0.1 pF has been omitted for less than 10 pF. Refer to the Part Number List for details.

Capacitance Table p00 Each number in the Part Number List refers to the page number printed at the bottom of the page.

(→ ■ GRM Series Temperature Compensating Type)

p00 ← Part Number List JIS: CK CJ CH SL PK PJ PH RK RJ RH SK SJ SH TK TJ TH UK UJ
 EIA: C0G P2H R2H S2H T2H U2J

| LxW (mm) | 1.6x0.8 | | 2.0x1.25 | | | | | | | | | | | | | | | | | | | | |
|---------------------|----------------|-----|----------|-----|-----|-----|----|-----|-----|------|-----|-----|----|-----|-----|-----|-----|-----|------|------|-----|-----|-----|
| | T max. (mm) | | 0.7 | | | | | | | 0.95 | | | | | | 1 | | | | | | | |
| Rated Voltage (Vdc) | 10 | | 100 | | 50 | | | | | 50 | | | | | 10 | | | 250 | | 50 | | | |
| | Cap. / TC Code | U2J | UJ | C0G | CH | C0G | CH | SL | U2J | UJ | C0G | CH | SL | U2J | UJ | SL | U2J | UJ | C0G | U2J | SL | U2J | UJ |
| 10pF | | | | | | | | | | | | | | | | | | | p136 | | | | |
| 12pF | | | | | | | | | | | | | | | | | | | p136 | | | | |
| 15pF | | | | | | | | | | | | | | | | | | | p136 | | | | |
| 18pF | | | | | | | | | | | | | | | | | | | p136 | | | | |
| 22pF | | | | | | | | | | | | | | | | | | | p136 | | | | |
| 27pF | | | | | | | | | | | | | | | | | | | p136 | | | | |
| 33pF | | | | | | | | | | | | | | | | | | | p136 | | | | |
| 39pF | | | | | | | | | | | | | | | | | | | p136 | | | | |
| 47pF | | | | | | | | | | | | | | | | | | | p136 | | | | |
| 56pF | | | | | | | | | | | | | | | | | | | p136 | | | | |
| 68pF | | | | | | | | | | | | | | | | | | | p136 | | | | |
| 82pF | | | | | | | | | | | | | | | | | | | p136 | | | | |
| 100pF | | | p62 | p62 | | | | | | | | | | | | | | | p136 | p137 | | | |
| 120pF | | | p62 | p62 | | | | | | | | | | | | | | | p136 | p137 | | | |
| 150pF | | | p62 | p62 | | | | | | | | | | | | | | | p136 | p137 | | | |
| 180pF | | | p62 | p62 | | | | | | | | | | | | | | | p136 | p137 | | | |
| 220pF | | | p62 | p62 | | | | | | | | | | | | | | | p136 | p137 | | | |
| 270pF | | | p62 | p62 | | | | | | | | | | | | | | | p136 | p137 | | | |
| 330pF | | | p62 | p62 | | | | | | | | | | | | | | | p136 | p137 | | | |
| 390pF | | | p62 | p62 | | | | | | | | | | | | | | | | p137 | | | |
| 470pF | | | p62 | p62 | | | | | | | | | | | | | | | | p137 | | | |
| 560pF | | | p62 | p62 | | | | | | | | | | | | | | | | p137 | | | |
| 680pF | | | p62 | p62 | | | | | | | | | | | | | | | | p137 | | | |
| 820pF | | | p62 | p62 | | | | | | | | | | | | | | | | p137 | | | |
| 1000pF | | | p62 | p62 | | | | | | | | | | | | | | | | p137 | | | |
| 1200pF | | | p62 | p62 | p62 | p62 | | | | | | | | | | | | | | p138 | | | |
| 1500pF | | | p62 | p62 | p62 | p62 | | | | | | | | | | | | | | p138 | | | |
| 1800pF | | | p62 | p62 | p62 | p62 | | | | | | | | | | | | | | p138 | | | |
| 2200pF | | | p62 | p62 | p62 | p62 | | | | | | | | | | | | | | p138 | | | |
| 2700pF | | | p62 | p62 | p62 | p62 | | | | | | | | | | | | | | | | | |
| 3300pF | | | p62 | p62 | p62 | p62 | | | | | | | | | | | | | | | | | |
| 3900pF | | | | | p62 | p62 | | | | | | | | | | | | | | | | | |
| 4700pF | | | | | p62 | p62 | | | | | | | | | | | | | | | | | |
| 5600pF | | | | | | | | | | p62 | p62 | | | | | | | | | | | | |
| 6800pF | | | | | | | | | | p62 | p62 | | | | | | | | | | | | |
| 8200pF | | | | | | | | | | p62 | p62 | | | | | | | | | | | | |
| 10000pF | | | | | | | | | | p62 | p62 | p62 | | | | | | | | | | | |
| 12000pF | p62 | p62 | | | | | | p62 | p62 | p62 | p62 | p62 | | | | | | | | | | | |
| 15000pF | p62 | p62 | | | | | | p62 | p62 | p62 | p62 | p62 | | | | | | | | | | | |
| 18000pF | p62 | p62 | | | | | | p62 | p62 | p62 | | | | | | | | | | | | | |
| 22000pF | p62 | p62 | | | | | | | | | | | | | p62 | p62 | p62 | | | | | | |
| 27000pF | | | | | | | | | | | | | | | p62 | p62 | p62 | | | | | | |
| 33000pF | | | | | | | | | | | | | | | | | | | | | p62 | p62 | p63 |
| 39000pF | | | | | | | | | | | | | | | | | | | | | | | |
| 47000pF | | | | | | | | | | | | | | | | | | | | | | | |
| 56000pF | | | | | | | | | | | | | | | | | | | | | p62 | p62 | p62 |



Capacitance Table

p00

Each number in the Part Number List refers to the page number printed at the bottom of the page.

(→ ■ GRM Series Temperature Compensating Type)

p00

← Part Number List

- JIS: CK CJ CH SL PK PJ PH RK RJ RH SK SJ SH TK TJ TH UK UJ
 EIA: C0G P2H R2H S2H T2H U2J

| LxW (mm) | 2.0x1.25 | | | | | | | | | 3.2x1.6 | | | | | | | | | | | | | | |
|---------------------|----------|-----|-----|-----|-----|-----|------|-----|-----|---------|-----|-----|-----|-----|-----|------|-----|------|------|------|------|------|------|------|
| T max. (mm) | 1.35 | | | | | | 1.45 | | | 0.95 | | | | | | 1 | | | | | | | | |
| Rated Voltage (Vdc) | 50 | | | 10 | | | 250 | | | 100 | | | 50 | | | 2000 | | 1000 | | 630 | | 250 | | |
| Cap. / TC Code | C0G | CH | SL | U2J | UJ | SL | U2J | UJ | U2J | C0G | CH | C0G | CH | SL | U2J | UJ | U2J | C0G | U2J | C0G | U2J | U2J | | |
| 10pF | | | | | | | | | | | | | | | | | | p139 | p137 | p139 | p136 | p138 | | |
| 12pF | | | | | | | | | | | | | | | | | | | p139 | p137 | p139 | p136 | p138 | |
| 15pF | | | | | | | | | | | | | | | | | | | p139 | p137 | p139 | p136 | p138 | |
| 18pF | | | | | | | | | | | | | | | | | | | p139 | p137 | p139 | p136 | p138 | |
| 22pF | | | | | | | | | | | | | | | | | | | p139 | p137 | p139 | p137 | p138 | |
| 27pF | | | | | | | | | | | | | | | | | | | p139 | p137 | p139 | p137 | p138 | |
| 33pF | | | | | | | | | | | | | | | | | | | p139 | p137 | p139 | p137 | p138 | |
| 39pF | | | | | | | | | | | | | | | | | | | p139 | p137 | p139 | p137 | p138 | |
| 47pF | | | | | | | | | | | | | | | | | | | p139 | p137 | p139 | p137 | p138 | |
| 56pF | | | | | | | | | | | | | | | | | | | p139 | p137 | p139 | p137 | p138 | |
| 68pF | | | | | | | | | | | | | | | | | | | p139 | p137 | p139 | p137 | p138 | |
| 82pF | | | | | | | | | | | | | | | | | | | | p137 | p139 | p137 | p138 | |
| 100pF | | | | | | | | | | | | | | | | | | | | p137 | p139 | p137 | p138 | |
| 120pF | | | | | | | | | | | | | | | | | | | | p137 | p139 | p137 | p138 | |
| 150pF | | | | | | | | | | | | | | | | | | | | p137 | p139 | p137 | p138 | |
| 180pF | | | | | | | | | | | | | | | | | | | | p137 | p139 | p137 | p138 | |
| 220pF | | | | | | | | | | | | | | | | | | | | p137 | p139 | p137 | p138 | |
| 270pF | | | | | | | | | | | | | | | | | | | | | p139 | p137 | p138 | |
| 330pF | | | | | | | | | | | | | | | | | | | | | p139 | p137 | p138 | |
| 390pF | | | | | | | | | | | | | | | | | | | | | | p137 | p138 | |
| 470pF | | | | | | | | | | | | | | | | | | | | | | p137 | p138 | |
| 560pF | | | | | | | | | | | | | | | | | | | | | | p137 | p138 | |
| 680pF | | | | | | | | | | | | | | | | | | | | | | | p138 | |
| 820pF | | | | | | | | | | | | | | | | | | | | | | | | p138 |
| 1000pF | | | | | | | | | | | | | | | | | | | | | | | | p138 |
| 1200pF | | | | | | | | | | | | | | | | | | | | | | | | p138 |
| 1500pF | | | | | | | | | | | | | | | | | | | | | | | | p138 |
| 1800pF | | | | | | | | | | | p63 | p63 | | | | | | | | | | | | p138 |
| 2200pF | | | | | | | | | | | p63 | p63 | | | | | | | | | | | | p138 |
| 2700pF | | | | | | | | | | p138 | p63 | p63 | | | | | | | | | | | | p138 |
| 3300pF | | | | | | | | | | p138 | p63 | p63 | | | | | | | | | | | | p138 |
| 3900pF | | | | | | | | | | p138 | p63 | p63 | | | | | | | | | | | | p138 |
| 4700pF | | | | | | | | | | p138 | p63 | p63 | | | | | | | | | | | | p138 |
| 5600pF | | | | | | | | | | p138 | p63 | p63 | | | | | | | | | | | | p138 |
| 6800pF | | | | | | | | | | | p63 | p63 | | | | | | | | | | | | |
| 8200pF | | | | | | | | | | | p63 | p63 | | | | | | | | | | | | |
| 10000pF | | | | | | | | | | | p63 | p63 | | | | | | | | | | | | |
| 12000pF | | | | | | | | | | | p63 | p63 | p63 | p63 | | | | | | | | | | |
| 15000pF | | | | | | | | | | | p63 | p63 | p63 | p63 | | | | | | | | | | |
| 18000pF | p63 | p63 | | | | | | | | | p63 | p63 | p63 | p63 | | | | | | | | | | |
| 22000pF | p63 | p63 | | | | | | | | | p63 | p63 | p63 | p63 | | | | | | | | | | |
| 27000pF | | | | | | | | | | | | | p63 | p63 | | | | | | | | | | |
| 33000pF | | | | | | | | | | | | | p63 | p63 | | | | | | | | | | |
| 39000pF | | | p63 | p63 | p63 | | | | | | | | p63 | p63 | | | | | | | | | | |
| 47000pF | | | p63 | p63 | p63 | | | | | | | | | | | | | | | | | | | |
| 56000pF | | | | | | | | | | | | | | | p63 | p63 | p63 | | | | | | | |
| 68000pF | | | | | | p63 | p63 | p63 | | | | | | | | | | | | | | | | |
| 82000pF | | | | | | p63 | p63 | p63 | | | | | | | | | | | | | | | | |
| 0.1μF | | | | | | p63 | p63 | p63 | | | | | | | | | | | | | | | | |

Capacitance Table p00 Each number in the Part Number List refers to the page number printed at the bottom of the page.

(→ ■ GRM Series Temperature Compensating Type)

p00 ← Part Number List
 JIS: CK CJ CH SL PK PJ PH RK RJ RH SK SJ SH TK TJ TH UK UJ
 EIA: C0G P2H R2H S2H T2H U2J

| LxW (mm) | 3.2x1.6 | | | | | | | | | | 3.2x2.5 | | | | | | | | | | | | |
|---------------------|---------|------|------|-----|-----|-----|-----|-----|-----|------|---------|------|------|------|------|------|------|------|------|------|-----|------|------|
| T max. (mm) | 1.25 | | | | | 1.8 | | | | | 1 | | 1.25 | | 1.5 | | 2 | | | | | | |
| Rated Voltage (Vdc) | 1000 | 630 | | 250 | 50 | | | | | 1000 | 630 | 50 | 2000 | 630 | 2000 | 1000 | 630 | 1000 | 630 | 1000 | 630 | | |
| Cap. / TC Code | U2J | C0G | U2J | U2J | C0G | CH | SL | U2J | UJ | U2J | U2J | C0G | CH | U2J | U2J | U2J | U2J | U2J | U2J | U2J | U2J | U2J | |
| 82pF | | | | | | | | | | | | | | p140 | | | | | | | | | |
| 100pF | | | | | | | | | | | | | | p140 | | | | | | | | | |
| 120pF | | | | | | | | | | | | | | p140 | | | | | | | | | |
| 150pF | | | | | | | | | | | | | | p140 | | | | | | | | | |
| 180pF | | | | | | | | | | | | | | | | p140 | | | | | | | |
| 220pF | | | | | | | | | | | | | | | | p140 | | | | | | | |
| 270pF | | | | | | | | | | | | | | | | | | | | | | | |
| 330pF | | | | | | | | | | | | | | | | | | | | | | | |
| 390pF | p139 | | | | | | | | | | | | | | | | | | | | | | |
| 470pF | p139 | | | | | | | | | | | | | | | | | | | | | | |
| 560pF | p139 | | | | | | | | | | | | | | | | | | | | | | |
| 680pF | p139 | p137 | | | | | | | | | | | | | | | | | | | | | |
| 820pF | | p137 | | | | | | | | p139 | | | | | | | | | | | | | |
| 1000pF | | p137 | | | | | | | | p139 | | | | | | | | | | | | | |
| 1200pF | | | | | | | | | | | | | | | | p138 | | p139 | | | | | |
| 1500pF | | | | | | | | | | | | | | | | p138 | | | p139 | | | | |
| 1800pF | | | | | | | | | | | | | | | | p138 | | | | | | p139 | |
| 2200pF | | | | | | | | | | | | | | | | p138 | | | | | | p139 | |
| 2700pF | | | p138 | | | | | | | | | | | | | | | | | | | | |
| 3300pF | | | p138 | | | | | | | | | | | | | | | | | | | | |
| 3900pF | | | | | | | | | | | | p138 | | | | | | | | | | | |
| 4700pF | | | | | | | | | | | | p138 | | | | | | | | | | | |
| 5600pF | | | | | | | | | | | | | | | | | p138 | | | | | | |
| 6800pF | | | | | | | | | | | | | | | | | | | | | | p138 | |
| 8200pF | | | | | | | | | | | | | | | | | | | | | | | p138 |
| 10000pF | | | | | | | | | | | | | | | | | | | | | | | p138 |
| 12000pF | | | | | | | | | | | | | | | | | | | | | | | |
| 15000pF | | | | | | | | | | | | | | | | | | | | | | | |
| 18000pF | | | | | | | | | | | | | | | | | | | | | | | |
| 22000pF | | | | | | | | | | | | | | | | | | | | | | | |
| 27000pF | | | | | | | | | | | | | | | | | | | | | | | |
| 33000pF | | | | | | | | | | | | | | | | | | | | | | | |
| 39000pF | | | | | | | | | | | | | | | | | | | | | | | |
| 47000pF | | | | | | p63 | p63 | | | | | | | | | | | | | | | | |
| 56000pF | | | | | | p63 | p63 | | | | | | | | | | | | | | | | |
| 68000pF | | | | | | | p63 | p63 | p63 | | | | | p63 | p63 | | | | | | | | |
| 82000pF | | | | | | | p63 | p63 | p63 | | | | | p63 | p63 | | | | | | | | |
| 0.1μF | | | | | | | p63 | p63 | p63 | | | | | p63 | p63 | | | | | | | | |



Capacitance Table p00 Each number in the Part Number List refers to the page number printed at the bottom of the page.

(→ ■ GRM Series Temperature Compensating Type)

p00 ← Part Number List JIS: CK CJ CH SL PK PJ PH RK RJ RH SK SJ SH TK TJ TH UK UJ
 EIA: C0G P2H R2H S2H T2H U2J

| LxW (mm) | 4.5x2.0 | 4.5x3.2 | | | | 5.7x5.0 | | | |
|---------------------|-------------|---------|------|------|------|---------|------|------|------|
| | T max. (mm) | 1 | 1.5 | 2 | 1.5 | 2 | 1.5 | 2 | |
| Rated Voltage (Vdc) | 3150 | 1000 | 630 | 1000 | 630 | 1000 | 630 | 1000 | 630 |
| Cap. / TC Code | U2J | U2J | U2J | U2J | U2J | U2J | U2J | U2J | U2J |
| 27pF | p140 | | | | | | | | |
| 33pF | p140 | | | | | | | | |
| 39pF | p140 | | | | | | | | |
| 47pF | p140 | | | | | | | | |
| 56pF | p140 | | | | | | | | |
| 68pF | p140 | | | | | | | | |
| 82pF | p140 | | | | | | | | |
| 100pF | p140 | | | | | | | | |
| 120pF | | | | | | | | | |
| 150pF | | | | | | | | | |
| 180pF | | | | | | | | | |
| 220pF | | | | | | | | | |
| 270pF | | | | | | | | | |
| 330pF | | | | | | | | | |
| 390pF | | | | | | | | | |
| 470pF | | | | | | | | | |
| 560pF | | | | | | | | | |
| 680pF | | | | | | | | | |
| 820pF | | | | | | | | | |
| 1000pF | | | | | | | | | |
| 1200pF | | | | | | | | | |
| 1500pF | | | | | | | | | |
| 1800pF | | | | | | | | | |
| 2200pF | | | | | | | | | |
| 2700pF | p139 | | | | | | | | |
| 3300pF | p139 | | | | | | | | |
| 3900pF | | | p139 | | | | | | |
| 4700pF | | | p139 | | | | | | |
| 5600pF | | | | | p139 | | | | |
| 6800pF | | | | | p139 | | | | |
| 8200pF | | | | | | | p139 | | |
| 10000pF | | | | | | | p139 | | |
| 12000pF | | p139 | | | | | | | |
| 15000pF | | | | p139 | | | | | |
| 18000pF | | | | p139 | | | | | |
| 22000pF | | | | p139 | | | | | |
| 27000pF | | | | | | p139 | | | |
| 33000pF | | | | | | | | | p139 |
| 39000pF | | | | | | | | | p139 |
| 47000pF | | | | | | | | | p139 |

Capacitance Table

p00

Each number in the Part Number List refers to the page number printed at the bottom of the page.

GRM Series High Dielectric Constant Type

p00

← Part Number List

JIS:

R

B

EIA:

X7R

X7S

X7T

X7U

X6S

X6T

X5R

X5S

| LxW (mm) | 0.4x0.2 | | | | 0.6x0.3 | | | | | | | | | | 1.0x0.5 | | | | | | | | |
|---------------------|---------|--------|--------|-----|---------|-----|--------|--------|--------|--------|--------|--------|--------|-----|---------|-----|--------|-----|--------|-----|-----|-----|-----|
| T max. (mm) | 0.22 | | | | 0.33 | | | | | | | | | | 0.22 | | | | | | | | |
| Rated Voltage (Vdc) | 10 | | 6.3 | 4 | 50 | | 25 | | 16 | | 10 | | 6.3 | | 4 | 10 | 6.3 | 4 | 2.5 | | | | |
| Cap. / TC Code | X7R | X5R, B | X5R, B | X5R | X7R | B | X7R, R | X5R, B | X7R, R | X5R, B | X7R, R | X5R, B | X7R, R | X6S | X5R, B | X6S | X5R, B | X6S | X5R, B | X7T | X6Δ | X7T | |
| 68pF | p64 | p64 | p64 | | | | | | | | | | | | | | | | | | | | |
| 100pF | p64 | p64 | p64 | | p65 | p65 | p65 | p65 | p65 | p65 | | | | | | | | | | | | | |
| 150pF | p64 | p64 | p64 | | p65 | p65 | p65 | p65 | p65 | p65 | | | | | | | | | | | | | |
| 220pF | p64 | p64 | p64 | | p65 | p65 | p65 | p65 | p65 | p65 | | | | | | | | | | | | | |
| 330pF | p64 | p64 | p64 | | p65 | p65 | p65 | p65 | p65 | p65 | | | | | | | | | | | | | |
| 470pF | p64 | p64 | p64 | | p65 | p65 | p65 | p65 | p65 | p65 | | | | | | | | | | | | | |
| 680pF | | p64 | p64 | p64 | p64 | | p65 | p65 | p65 | p65 | p65 | | | | | | | | | | | | |
| 1000pF | | p64 | p64 | p64 | p64 | | p65 | p65 | p65 | p65 | p65 | | | | | | | | | | | | |
| 1500pF | | p64 | p64 | p64 | p64 | | p65 | p65 | p65 | p65 | p65 | | | | | | | | | | | | |
| 2200pF | | p64 | p64 | p64 | p64 | | | | p65 | p65 | p65 | p65 | p65 | | | | | | | | | | |
| 3300pF | | p64 | p64 | p64 | p64 | | | | p65 | p65 | p65 | p65 | p65 | | | | | | | | | | |
| 4700pF | | p64 | p64 | p64 | p64 | | | | | | p65 | p65 | p65 | p66 | p66 | p66 | | p66 | | | | | |
| 6800pF | | p64 | p64 | p64 | p64 | | | | | | p65 | p65 | p66 | p66 | p66 | p66 | | p66 | | | | | |
| 10000pF | | p64 | p64 | p64 | p64 | | | | p65 | p65 | p65 | p65 | p66 | p66 | p66 | p66 | | p66 | p66 | | | | |
| 12000pF | | | | | | | | | | | | | p66 | p66 | | | | | | | | | |
| 15000pF | | | p64 | p64 | | | | | | | | | p66 | p66 | | p66 | p66 | p66 | | | | | |
| 18000pF | | | | | | | | | | | | | p66 | p66 | | | | | | | | | |
| 22000pF | | | p64 | p64 | | | | | | | | | p66 | p66 | | p66 | p66 | p66 | | | | | |
| 27000pF | | | | | | | | | | | | | p66 | p66 | | | | | | | | | |
| 33000pF | | | p64 | p64 | | | | | | | | | p66 | p66 | | p66 | p66 | p66 | | | | | |
| 39000pF | | | | | | | | | | | | | p66 | p66 | | | | | | | | | |
| 47000pF | | | p64 | p64 | | | | | | | | | p66 | p66 | | p66 | p66 | p66 | | | | | |
| 68000pF | | | p64 | p64 | | | | | | | | | p66 | p66 | | p66 | | | | | | | |
| 0.1μF | | | p64 | p64 | | | | | | p65 | p65 | | p66 | p66 | | p66 | | p66 | p66 | p67 | p67 | p67 | p67 |
| 0.15μF | | | | | | | | | | | | | | | | | | | | | | | |
| 0.22μF | | | | | | | | | | | | | p66 | | p66 | p66 | p66 | p66 | p66 | p67 | p67 | p67 | p67 |
| 0.33μF | | | | | | | | | | | | | | | | | | | | | | | |
| 0.47μF | | | | | | | | | | | | | | | | | | | | p67 | p67 | | p67 |
| 0.68μF | | | | | | | | | | | | | | | | | | | | | | | |
| 1.0μF | | | | | | | | | | | | | | | | | | | | | | | |
| 2.2μF | | | | | | | | | | | | | | | | | | | | | | | |
| 4.7μF | | | | | | | | | | | | | | | | | | | | | | | |
| 10μF | | | | | | | | | | | | | | | | | | | | | | | |
| 22μF | | | | | | | | | | | | | | | | | | | | | | | |
| 47μF | | | | | | | | | | | | | | | | | | | | | | | |
| 100μF | | | | | | | | | | | | | | | | | | | | | | | |
| 150μF | | | | | | | | | | | | | | | | | | | | | | | |



Capacitance Table

p00

Each number in the Part Number List refers to the page number printed at the bottom of the page.

(→ ■ GRM Series High Dielectric Constant Type)

p00 ← Part Number List JIS: R B EIA: X7R X7S X7T X7U X6S X6T X5R X5S

| LxW (mm) | 1.0x0.5 | | | | | | | | | | | | | | | | | | | | | |
|---------------------|---------|-----|-----|-----|------|-----|------|--------|------|--------|------|-----|------|--------|------|--------|--------|-----|--------|--------|--------|--------|
| | 0.3 | | | | | | 0.33 | | | | | | 0.55 | | | | | | | | | |
| T max. (mm) | 0.3 | | | | 0.33 | | | | 0.55 | | 0.55 | | 0.55 | | 0.55 | | 0.55 | | 0.55 | | | |
| Rated Voltage (Vdc) | 50 | 25 | 16 | 10 | 10 | 6.3 | 4 | 100 | 50 | 25 | 16 | 10 | 100 | 50 | 25 | 16 | 10 | 100 | 50 | 25 | 16 | 10 |
| Cap. / TC Code | X7R, R | B | X7R | B | X7R | B | X5R | X5R, B | X6T | X5R, B | X6T | X5R | X7R | X7Δ, R | X6S | X5R, B | X7R, R | X6S | X5R, B | X7R, R | X5R, B | X7R, R |
| 68pF | | | | | | | | | | | | | | | | | | | | | | |
| 100pF | | | | | | | | | | | | | | | | | | | | | | |
| 150pF | | | | | | | | | | | | | | | | | | | | | | |
| 220pF | p67 | p67 | p67 | | | | | | | | | | p67 | p67 | p68 | | p68 | | | | | |
| 330pF | p67 | p67 | p67 | | | | | | | | | | p67 | p67 | p68 | | p68 | | | | | |
| 470pF | p67 | p67 | p67 | | | | | | | | | | p67 | p67 | p68 | | p68 | | | | | |
| 680pF | p67 | p67 | p67 | | | | | | | | | | p67 | p67 | p68 | | p68 | | | | | |
| 1000pF | p67 | p67 | p67 | | | | | | | | | | p67 | p67 | p68 | | p68 | p68 | | | | |
| 1500pF | p67 | p67 | p67 | | | | | | | | | | p67 | p67 | p68 | | p68 | | | | | |
| 2200pF | | p67 | p67 | | | | | | | | | | p67 | p67 | p68 | | p68 | p68 | | | | |
| 3300pF | | | p67 | p67 | | | | | | | | | p67 | p67 | p68 | | p68 | | | | | |
| 4700pF | | | p67 | p67 | | | | | | | | | p67 | p67 | p68 | | p68 | p68 | | | p68 | |
| 6800pF | | | p67 | p67 | | | | | | | | | p67 | p68 | | p68 | p68 | p68 | | | p68 | |
| 10000pF | | | p67 | p67 | | | | | | | | | p67 | p68 | | p68 | p68 | p68 | | | p68 | |
| 12000pF | | | | | | | | | | | | | | | | | | | | | | |
| 15000pF | | | | | p67 | | | | | | | | p67 | | | p68 | p68 | p68 | | | p68 | |
| 18000pF | | | | | p67 | | | | | | | | p67 | | | p68 | p68 | p68 | | | p68 | |
| 22000pF | | | | | p67 | | | | | | | | p67 | | | p68 | p68 | p68 | | | p68 | |
| 27000pF | | | | | | | | | | | | | | | | | | | | | | |
| 33000pF | | | | | p67 | | | | | | | | p67 | | | p68 | p68 | p68 | | | p68 | p68 |
| 39000pF | | | | | | | | | | | | | | | | | | | | | | |
| 47000pF | | | | | | | | | | | | | | p68 | | p68 | p68 | p68 | | | p68 | p68 |
| 68000pF | | | | | | | | | | | | | | p68 | | p68 | | p68 | p68 | p68 | p68 | p68 |
| 0.1μF | | | | | | | | | | | | | | p68 | p68 | p68 | p68 | p68 | | | | |
| 0.15μF | | | | | | | | | | | | | | | | | | | | | p68 | |
| 0.22μF | | | | | | | | | | | | | | | | | | | | | p68 | |
| 0.33μF | | | | | | | | | | | | | | | | | | | | | | |
| 0.47μF | | | | | | | | | | | | | | | | | | | | | | |
| 0.68μF | | | | | | | | | | | | | | | | | | | | | | |
| 1.0μF | | | | | | | | p67 | p67 | p67 | p67 | p67 | p67 | | | | | | | p68 | p68 | p69 |
| 2.2μF | | | | | | | | | | | | | | | | | | | | | | |
| 4.7μF | | | | | | | | | | | | | | | | | | | | | | |
| 10μF | | | | | | | | | | | | | | | | | | | | | | |
| 22μF | | | | | | | | | | | | | | | | | | | | | | |
| 47μF | | | | | | | | | | | | | | | | | | | | | | |
| 100μF | | | | | | | | | | | | | | | | | | | | | | |
| 150μF | | | | | | | | | | | | | | | | | | | | | | |



Capacitance Table p00 Each number in the Part Number List refers to the page number printed at the bottom of the page.

(→ ■ GRM Series High Dielectric Constant Type)

p00 ← Part Number List JIS: R B EIA: X7R X7S X7T X7U X6S X6T X5R X5S

| LxW (mm) | 1.0x0.5 | | | | | | | | | | 1.6x0.8 | | | | | | | | | | | | |
|---------------------|---------|--------|-----|-----|-----|-----------|----------|-------------|-------------|------------|---------|--------|------|-----|--------|--------|--------|-----|--------|--------------|-----|--------------------------|--------------------------|
| | 0.55 | | | | | 0.55, 0.6 | 0.6, 0.7 | 0.6 | 0.7 | 0.5 | | | | | 0.9 | | | | | 0.9, 0.95, 1 | | | |
| T max. (mm) | | | | | | | | | | 25 | 16 | 250 | 100 | 50 | 25 | 16 | 6.3 | 2.5 | 25 | | | | |
| Rated Voltage (Vdc) | 10 | 6.3 | 4 | 6.3 | 4 | 2.5 | 2.5 | 25 | 16 | 250 | 100 | 50 | 25 | 16 | 6.3 | 2.5 | 25 | | | | | | |
| Cap. / TC Code | X6S | X5R, B | X7R | X6S | X7R | X6Δ | X5R, B | X5R, B | X6T | X5R | X5R, B | X5R, B | X7R | X7R | X7R, R | X5R, B | X7R, R | X6S | X7Δ, R | X6S | X6S | X5R, B | |
| 68pF | | | | | | | | | | | | | | | | | | | | | | | |
| 100pF | | | | | | | | | | | | | | | | | | | | | | | |
| 150pF | | | | | | | | | | | | | | | | | | | | | | | |
| 220pF | | | | | | | | | | | | | p143 | p69 | p70 | p70 | p70 | | | | | | |
| 330pF | | | | | | | | | | | | | p143 | p69 | p70 | p70 | p70 | | | | | | |
| 470pF | | | | | | | | | | | | | p143 | p69 | p70 | p70 | p70 | | | | | | |
| 680pF | | | | | | | | | | | | | p143 | p70 | p70 | p70 | p70 | | | | | | |
| 1000pF | | | | | | | | | | | | | p143 | p70 | p70 | p70 | p70 | | | | | | |
| 1500pF | | | | | | | | | | | | | p143 | p70 | p70 | p70 | p70 | | | | | | |
| 2200pF | | | | | | | | | | | | | p143 | p70 | p70 | p70 | p70 | | | | | | 0.9 p71 |
| 3300pF | | | | | | | | | | | | | | p70 | p70 | p70 | p70 | | | | | | 0.9 p71 |
| 4700pF | | | | | | | | | | | | | | p70 | p70 | p70 | p70 | | | | | | 0.9 p71 |
| 6800pF | | | | | | | | | | | | | | p70 | p70 | p70 | p70 | | | | | | 0.9 p71 |
| 10000pF | | | | | | | | | | | | | | p70 | p70 | p70 | p70 | | | | | | 0.9 p71 |
| 12000pF | | | | | | | | | | | | | | | | | | | | | | | |
| 15000pF | | | | | | | | | | | | | | p70 | p70 | p70 | p70 | p70 | p71 | | | | 0.9 p71 |
| 18000pF | | | | | | | | | | | | | | | | | | | | | | | |
| 22000pF | | | | | | | | | | | | | | p70 | p70 | p70 | p70 | p70 | p71 | | | | 0.9 p71 |
| 27000pF | | | | | | | | | | | | | | | | | | | | | | | |
| 33000pF | | | | | | | | | | | | | | p70 | p70 | p70 | p70 | p71 | | | | | 0.9 p71 |
| 39000pF | | | | | | | | | | | | | | | | | | | | | | | |
| 47000pF | | | | | | | | | | | | | | p70 | p70 | p70 | p70 | p71 | | | | | 0.9 p71 |
| 68000pF | | | | | | | | | | | | | | p70 | p70 | p70 | p70 | | | | | | 0.9 p71 |
| 0.1μF | | | | | | | | | | | | | | p70 | p70 | p70 | p70 | | | | | | 0.9 p71 0.9 p71 |
| 0.15μF | | p69 | p69 | | p69 | | p69 | 0.55 p69 | 0.55 p69 | | | | | | | p70 | p70 | p71 | | p71 | p71 | | 0.9 p71 |
| 0.22μF | | p69 | p69 | | p69 | | p69 | 0.55 p69 | 0.55 p69 | | | | | | | p70 | p70 | p70 | p71 | | p71 | p71 | 0.9 p71 0.9 p71 |
| 0.33μF | | p69 | p69 | | p69 | | p69 | 0.55 p69 | 0.55 p69 | | | | | | | | | | | p71 | p71 | | 0.9 p71 |
| 0.47μF | | p69 | p69 | | p69 | | p69 | 0.55 p69 | 0.55 p69 | | | | | | | p70 | p70 | | | p71 | p71 | | 0.9 p71 0.9 p71 |
| 0.68μF | | p69 | p69 | | | | | 0.55 p69 | 0.55 p69 | | | | | | | | | | | p71 | | | 0.9 p71 0.9 p71 |
| 1.0μF | p69 | | p69 | | p69 | | | | | | p69 | p69 | p69 | p69 | | p70 | p70 | p70 | p71 | p71 | | 0.9 p71 0.9 p71 | |
| 2.2μF | | p69 | p69 | | p69 | | p69 | 0.55 p69 | 0.55 p69 | | | | | | | | | | | | p71 | | 0.9 p71 0.9 p71 |
| 4.7μF | | | | | | | | 0.6 p69 | 0.6 p69 | 0.6 p69 | p69 | | | | | | | | | | p72 | | 0.95, 1 p72 |
| 10μF | | | | | | | | | | | | | | | | | | | | | | p72 | 1 p72 |
| 22μF | | | | | | | | | | | | | | | | | | | | | | | |
| 47μF | | | | | | | | | | | | | | | | | | | | | | | |
| 100μF | | | | | | | | | | | | | | | | | | | | | | | |
| 150μF | | | | | | | | | | | | | | | | | | | | | | | |



Capacitance Table p00 Each number in the Part Number List refers to the page number printed at the bottom of the page.

(→ ■ GRM Series High Dielectric Constant Type)

p00 ← Part Number List JIS: R B EIA: X7R X7S X7T X7U X6S X6T X5R X5S

| LxW (mm) | 1.6x0.8 | | | | | | | | | | 2.0x1.25 | | | | | | | | | | | | | | | | | |
|---------------------|--------------|-----|--------|-----|-----|--------|-----|--------|-----------|-----|----------|-----|-----|--------|------|-----|-----|---|-----|-----|----|-----|----|--|----|--|----|--|
| | 0.9, 0.95, 1 | | 0.9, 1 | | | | | | 0.9, 0.95 | | 1 | | 0.7 | | 0.95 | | | | | | | | | | | | | |
| T max. (mm) | 16 | | 16 | | 10 | | 6.3 | | 4 | | 10 | | 35 | | 25 | | 16 | | 100 | | 50 | | 35 | | 25 | | 16 | |
| Rated Voltage (Vdc) | 16 | | 16 | | 10 | | 6.3 | | 4 | | 10 | | 35 | | 25 | | 16 | | 100 | | 50 | | 35 | | 25 | | 16 | |
| Cap. / TC Code | X5R, B | X6S | X7Δ | X6S | X7Δ | X5R, B | X6S | X5R, B | X5R, B | X5R | X5R | X6S | X7R | X5R, B | X6S | X5R | X7R | R | X6S | X5R | B | X7R | | | | | | |
| 68pF | | | | | | | | | | | | | | | | | | | | | | | | | | | | |
| 100pF | | | | | | | | | | | | | | | | | | | | | | | | | | | | |
| 150pF | | | | | | | | | | | | | | | | | | | | | | | | | | | | |
| 220pF | | | | | | | | | | | | | | | | | | | | | | | | | | | | |
| 330pF | | | | | | | | | | | | | | | | | | | | | | | | | | | | |
| 470pF | | | | | | | | | | | | | | | | | | | | | | | | | | | | |
| 680pF | | | | | | | | | | | | | | | | | | | | | | | | | | | | |
| 1000pF | | | | | | | | | | | | | | | | | | | | | | | | | | | | |
| 1500pF | | | | | | | | | | | | | | | | | | | | | | | | | | | | |
| 2200pF | | | | | | | | | | | | | | | | | | | | | | | | | | | | |
| 3300pF | | | | | | | | | | | | | | | | | | | | | | | | | | | | |
| 4700pF | | | | | | | | | | | | | | | | | | | | | | | | | | | | |
| 6800pF | | | | | | | | | | | | | | | | | | | | | | | | | | | | |
| 10000pF | | | | | | | | | | | | | | | | | | | | | | | | | | | | |
| 12000pF | | | | | | | | | | | | | | | | | | | | | | | | | | | | |
| 15000pF | | | | | | | | | | | | | | | | | | | | | | | | | | | | |
| 18000pF | | | | | | | | | | | | | | | | | | | | | | | | | | | | |
| 22000pF | | | | | | | | | | | | | | | | | | | | | | | | | | | | |
| 27000pF | | | | | | | | | | | | | | | | | | | | | | | | | | | | |
| 33000pF | | | | | | | | | | | | | | | | | | | | | | | | | | | | |
| 39000pF | | | | | | | | | | | | | | | | | | | | | | | | | | | | |
| 47000pF | | | | | | | | | | | | | | | | | | | | | | | | | | | | |
| 68000pF | | | | | | | | | | | | | | | | | | | | | | | | | | | | |
| 0.1μF | | | | | | | | | | | | | | | | | | | | | | | | | | | | |
| 0.15μF | | | | | | | | | | | | | | | | | | | | | | | | | | | | |
| 0.22μF | | | | | | | | | | | | | | | | | | | | | | | | | | | | |
| 0.33μF | | | | | | | | | | | | | | | | | | | | | | | | | | | | |
| 0.47μF | | | | | | | | | | | | | | | | | | | | | | | | | | | | |
| 0.68μF | | | | | | | | | | | | | | | | | | | | | | | | | | | | |
| 1.0μF | | | | | | | | | | | | | | | | | | | | | | | | | | | | |
| 2.2μF | | | | | | | | | | | | | | | | | | | | | | | | | | | | |
| 4.7μF | | | | | | | | | | | | | | | | | | | | | | | | | | | | |
| 10μF | | | | | | | | | | | | | | | | | | | | | | | | | | | | |
| 22μF | | | | | | | | | | | | | | | | | | | | | | | | | | | | |
| 47μF | | | | | | | | | | | | | | | | | | | | | | | | | | | | |
| 100μF | | | | | | | | | | | | | | | | | | | | | | | | | | | | |
| 150μF | | | | | | | | | | | | | | | | | | | | | | | | | | | | |



Capacitance Table

p00

Each number in the Part Number List refers to the page number printed at the bottom of the page.

(→ ■ GRM Series High Dielectric Constant Type)

p00 ← Part Number List JIS: R B EIA: X7R X7S X7T X7U X6S X6T X5R X5S

| LxW (mm) | 2.0x1.25 | | | | | | | | | | | | | | | | | | | | | |
|---------------------|----------|-----|-----|---|-----|-----|---|-----|-----|---|-----|-----|---------|-----|-----|-----|--------|--------|--------|-----|--------|-----|
| T max. (mm) | 0.95 | | | | | | | | | | | | 0.95, 1 | | 1 | | 1.35 | | | | | |
| Rated Voltage (Vdc) | 16 | | | | 10 | | | | 6.3 | | | | 4 | | 50 | 250 | 100 | 100 | 50 | 25 | | 16 |
| Cap. / TC Code | R | X6S | X5R | B | X7Δ | X5R | B | X6S | X5R | B | X6S | X5R | X7R, R | X7R | X7R | X7R | X7R, R | X5R, B | X7R, R | X6S | X5R, B | X7R |
| 68pF | | | | | | | | | | | | | | | | | | | | | | |
| 100pF | | | | | | | | | | | | | | | | | | | | | | |
| 150pF | | | | | | | | | | | | | | | | | | | | | | |
| 220pF | | | | | | | | | | | | | | | | | | | | | | |
| 330pF | | | | | | | | | | | | | | | | | | | | | | |
| 470pF | | | | | | | | | | | | | | | | | | | | | | |
| 680pF | | | | | | | | | | | | | | | | | | | | | | |
| 1000pF | | | | | | | | | | | | | | | | | | | | | | |
| 1500pF | | | | | | | | | | | | | | | | | | | | | | |
| 2200pF | | | | | | | | | | | | | | | | | | | | | | |
| 3300pF | | | | | | | | | | | | | | | | | | | | | | |
| 4700pF | | | | | | | | | | | | | | | | | | | | | | |
| 6800pF | | | | | | | | | | | | | | | | | | | | | | |
| 10000pF | | | | | | | | | | | | | | | | | | | | | | |
| 12000pF | | | | | | | | | | | | | | | | | | | | | | |
| 15000pF | | | | | | | | | | | | | | | | | | | | | | |
| 18000pF | | | | | | | | | | | | | | | | | | | | | | |
| 22000pF | | | | | | | | | | | | | | | | | | | | | | |
| 27000pF | | | | | | | | | | | | | | | | | | | | | | |
| 33000pF | | | | | | | | | | | | | | | | | | | | | | |
| 39000pF | | | | | | | | | | | | | | | | | | | | | | |
| 47000pF | | | | | | | | | | | | | | | | | | | | | | |
| 68000pF | | | | | | | | | | | | | | | | | | | | | | |
| 0.1μF | | | | | | | | | | | | | | | | | | | | | | |
| 0.15μF | | | | | | | | | | | | | | | | | | | | | | |
| 0.22μF | | | | | | | | | | | | | | | | | | | | | | |
| 0.33μF | | | | | | | | | | | | | | | | | | | | | | |
| 0.47μF | | | | | | | | | | | | | | | | | | | | | | |
| 0.68μF | | | | | | | | | | | | | | | | | | | | | | |
| 1.0μF | | | | | | | | | | | | | | | | | | | | | | |
| 2.2μF | | | | | | | | | | | | | | | | | | | | | | |
| 4.7μF | | | | | | | | | | | | | | | | | | | | | | |
| 10μF | | | | | | | | | | | | | | | | | | | | | | |
| 22μF | | | | | | | | | | | | | | | | | | | | | | |
| 47μF | | | | | | | | | | | | | | | | | | | | | | |
| 100μF | | | | | | | | | | | | | | | | | | | | | | |
| 150μF | | | | | | | | | | | | | | | | | | | | | | |



Capacitance Table

p00

Each number in the Part Number List refers to the page number printed at the bottom of the page.

(→ ■ GRM Series High Dielectric Constant Type)

p00

← Part Number List

JIS:

R

B

EIA:

X7R

X7S

X7T

X7U

X6S

X6T

X5R

X5S

| LxW (mm) | 2.0x1.25 | | | | | | | | | | | | | | | | | | | | | | |
|---------------------|----------|--------|-----|-----|-----|--------|--------|--------|-----|-----|-----|---|-----|-----|--------|-----|------|-----|-----|--------|-----|--------|-----------------|
| T max. (mm) | 1.35 | | | | 1.4 | | | | | | | | | | | | 1.45 | | | | | | |
| Rated Voltage (Vdc) | 16 | | 10 | 6.3 | 100 | 50 | 25 | | 16 | | 10 | | 6.3 | | 4 | | 250 | 25 | 6.3 | 4 | | | |
| Cap. / TC Code | X6S | X5R, B | X6S | X6S | X7R | X5R, B | X7R, R | X5R, B | X7R | X6S | X7R | B | X7R | X6S | X5R, B | X7U | X6S | X7R | X5R | X5R, B | X6S | X5R, B | |
| 68pF | | | | | | | | | | | | | | | | | | | | | | | |
| 100pF | | | | | | | | | | | | | | | | | | | | | | | |
| 150pF | | | | | | | | | | | | | | | | | | | | | | | |
| 220pF | | | | | | | | | | | | | | | | | | | | | | | |
| 330pF | | | | | | | | | | | | | | | | | | | | | | | |
| 470pF | | | | | | | | | | | | | | | | | | | | | | | |
| 680pF | | | | | | | | | | | | | | | | | | | | | | | |
| 1000pF | | | | | | | | | | | | | | | | | | | | | | | |
| 1500pF | | | | | | | | | | | | | | | | | | | | | | | |
| 2200pF | | | | | | | | | | | | | | | | | | | | | | | |
| 3300pF | | | | | | | | | | | | | | | | | | | | | | | |
| 4700pF | | | | | | | | | | | | | | | | | | | | | | | |
| 6800pF | | | | | | | | | | | | | | | | | | | | | | | |
| 10000pF | | | | | | | | | | | | | | | | | | | | | | | p143 |
| 12000pF | | | | | | | | | | | | | | | | | | | | | | | |
| 15000pF | | | | | | | | | | | | | | | | | | | | | | | |
| 18000pF | | | | | | | | | | | | | | | | | | | | | | | |
| 22000pF | | | | | | | | | | | | | | | | | | | | | | | |
| 27000pF | | | | | | | | | | | | | | | | | | | | | | | |
| 33000pF | | | | | | | | | | | | | | | | | | | | | | | |
| 39000pF | | | | | | | | | | | | | | | | | | | | | | | |
| 47000pF | | | | | | | | | | | | | | | | | | | | | | | |
| 68000pF | | | | | | | | | | | | | | | | | | | | | | | |
| 0.1μF | | | | | | | | | | | | | | | | | | | | | | | |
| 0.15μF | | | | | | | | | | | | | | | | | | | | | | | |
| 0.22μF | | | | | | | | | | | | | | | | | | | | | | | |
| 0.33μF | | | | | | | | | | | | | | | | | | | | | | | |
| 0.47μF | | | | | | | | | | | | | | | | | | | | | | | p73 |
| 0.68μF | | | | | | | | | | | | | | | | | | | | | | | |
| 1.0μF | | | | | | | | | | | | | | | | | | | | | | | p73 p73 p73 |
| 2.2μF | | | | | | | | | | | | | | | | | | | | | | | p73 p73 |
| 4.7μF | | | | | | | | | | | | | | | | | | | | | | | p73 p73 p73 |
| 10μF | | | | | | | | | | | | | | | | | | | | | | | p73 p73 p73 p73 |
| 22μF | | | | | | | | | | | | | | | | | | | | | | | p73 p73 p73 p73 |
| 47μF | | | | | | | | | | | | | | | | | | | | | | | p73 p73 p73 p73 |
| 100μF | | | | | | | | | | | | | | | | | | | | | | | p73 p73 p73 p73 |
| 150μF | | | | | | | | | | | | | | | | | | | | | | | p73 p73 p73 p73 |



Capacitance Table

p00

Each number in the Part Number List refers to the page number printed at the bottom of the page.

(→ ■ GRM Series High Dielectric Constant Type)

p00 ← Part Number List JIS: R B EIA: X7R X7S X7T X7U X6S X6T X5R X5S

| LxW (mm) | 3.2x1.6 | | | | | | | | | | | | | | | | | | | | | | |
|---------------------|---------|-----|------|-----|-----|--------|----|-----|--------|--------|-----|--------|-----|-----|-----|--------|-----|-----------|---|-----|--------|-----|--|
| T max. (mm) | 0.7 | | 0.95 | | | | | | | | | 1.25 | | | | | | 1.25, 1.3 | | 1.8 | | | |
| Rated Voltage (Vdc) | 25 | 16 | 100 | 50 | 35 | 25 | 16 | 10 | 6.3 | 1000 | 630 | 250 | 50 | 16 | 100 | 25 | 630 | | | | | | |
| Cap. / TC Code | X5R, B | X6S | X7R | X7R | X5R | X7R, R | B | X6S | X5R, B | X5R, B | X6S | X5R, B | X7R | X7R | X7R | X7R, R | B | X6S | B | X7R | X5R, B | X7R | |
| 68pF | | | | | | | | | | | | | | | | | | | | | | | |
| 100pF | | | | | | | | | | | | | | | | | | | | | | | |
| 150pF | | | | | | | | | | | | | | | | | | | | | | | |
| 220pF | | | | | | | | | | | | | | | | | | | | | | | |
| 330pF | | | | | | | | | | | | | | | | | | | | | | | |
| 470pF | | | | | | | | | | | | | | | | | | | | | | | |
| 680pF | | | | | | | | | | | | | | | | | | | | | | | |
| 1000pF | | | | | | | | | | | | | | | | | | | | | | | |
| 1500pF | | | | | | | | | | | | | | | | | | | | | | | |
| 2200pF | | | | | | | | | | | | | | | | | | | | | | | |
| 3300pF | | | | | | | | | | | | | | | | | | | | | | | |
| 4700pF | | | | | | | | | | | | | | | | | | | | | | | |
| 6800pF | | | | | | | | | | | | | | | | | | | | | | | |
| 10000pF | | | | | | | | | | | | | | | | | | | | | | | |
| 12000pF | | | | | | | | | | | | | | | | | | | | | | | |
| 15000pF | | | | | | | | | | | | | | | | | | | | | | | |
| 18000pF | | | | | | | | | | | | | | | | | | | | | | | |
| 22000pF | | | | | | | | | | | | | | | | | | | | | | | |
| 27000pF | | | | | | | | | | | | | | | | | | | | | | | |
| 33000pF | | | | | | | | | | | | | | | | | | | | | | | |
| 39000pF | | | | | | | | | | | | | | | | | | | | | | | |
| 47000pF | | | | | | | | | | | | | | | | | | | | | | | |
| 68000pF | | | | | | | | | | | | | | | | | | | | | | | |
| 0.1μF | | | | | | | | | | | | | | | | | | | | | | | |
| 0.15μF | | | | | | | | | | | | | | | | | | | | | | | |
| 0.22μF | | | | | | | | | | | | | | | | | | | | | | | |
| 0.33μF | | | | | | | | | | | | | | | | | | | | | | | |
| 0.47μF | | | | | | | | | | | | | | | | | | | | | | | |
| 0.68μF | | | | | | | | | | | | | | | | | | | | | | | |
| 1.0μF | | | | | | | | | | | | | | | | | | | | | | | |
| 2.2μF | | | | | | | | | | | | | | | | | | | | | | | |
| 4.7μF | | | | | | | | | | | | | | | | | | | | | | | |
| 10μF | | | | | | | | | | | | | | | | | | | | | | | |
| 22μF | | | | | | | | | | | | | | | | | | | | | | | |
| 47μF | | | | | | | | | | | | | | | | | | | | | | | |
| 100μF | | | | | | | | | | | | | | | | | | | | | | | |
| 150μF | | | | | | | | | | | | | | | | | | | | | | | |



Capacitance Table p00 Each number in the Part Number List refers to the page number printed at the bottom of the page.

(→ ■ GRM Series High Dielectric Constant Type)

p00 ← Part Number List JIS: R B EIA: X7R X7S X7T X7U X6S X6T X5R X5S

| LxW (mm) | 3.2x1.6 | | | | | | | | | | | | | | | | | 3.2x2.5 | | | | | |
|---------------------|---------|-----|--------|-----|-----|--------|--------|-----|--------|-----|-----|--------|----------|-----|-----|------------|------------|------------|------------|------------|-----|-----|-----|
| | 1.8 | | | | | | | | | | | | 1.8, 1.9 | | | | 1.9 | 1 | | | | | |
| T max. (mm) | 1.8 | | | | | | | | | | | | 1.8, 1.9 | | | | 1.9 | 1 | | | | | |
| Rated Voltage (Vdc) | 250 | 50 | | 25 | | 16 | | 10 | | 6.3 | | 100 | 6.3 | 4 | | 4 | 6.3 | 4 | | | | | |
| Cap. / TC Code | X7R | X7R | X5R, B | X7R | X6S | X5R, B | X7R, R | X6S | X5R, B | X7R | X6S | X5R, B | X7Δ | X7R | X6Δ | X5R, B | X7U | X6Δ | X5R | X5S | X6T | X5S | |
| 68pF | | | | | | | | | | | | | | | | | | | | | | | |
| 100pF | | | | | | | | | | | | | | | | | | | | | | | |
| 150pF | | | | | | | | | | | | | | | | | | | | | | | |
| 220pF | | | | | | | | | | | | | | | | | | | | | | | |
| 330pF | | | | | | | | | | | | | | | | | | | | | | | |
| 470pF | | | | | | | | | | | | | | | | | | | | | | | |
| 680pF | | | | | | | | | | | | | | | | | | | | | | | |
| 1000pF | | | | | | | | | | | | | | | | | | | | | | | |
| 1500pF | | | | | | | | | | | | | | | | | | | | | | | |
| 2200pF | | | | | | | | | | | | | | | | | | | | | | | |
| 3300pF | | | | | | | | | | | | | | | | | | | | | | | |
| 4700pF | | | | | | | | | | | | | | | | | | | | | | | |
| 6800pF | | | | | | | | | | | | | | | | | | | | | | | |
| 10000pF | | | | | | | | | | | | | | | | | | | | | | | |
| 12000pF | | | | | | | | | | | | | | | | | | | | | | | |
| 15000pF | | | | | | | | | | | | | | | | | | | | | | | |
| 18000pF | | | | | | | | | | | | | | | | | | | | | | | |
| 22000pF | | | | | | | | | | | | | | | | | | | | | | | |
| 27000pF | | | | | | | | | | | | | | | | | | | | | | | |
| 33000pF | p143 | | | | | | | | | | | | | | | | | | | | | | |
| 39000pF | | | | | | | | | | | | | | | | | | | | | | | |
| 47000pF | p143 | | | | | | | | | | | | | | | | | | | | | | |
| 68000pF | | | | | | | | | | | | | | | | | | | | | | | |
| 0.1μF | p143 | | | | | | | | | | | | | | | | | | | | | | |
| 0.15μF | | | | | | | | | | | | | | | | | | | | | | | |
| 0.22μF | | | | | | | | | | | | | | | | | | | | | | | |
| 0.33μF | | | | | | | | | | | | | | | | | | | | | | | |
| 0.47μF | | | | | | | | | | | | | | | | | | | | | | | |
| 0.68μF | | | | | | | | | | | | | | | | | | | | | | | |
| 1.0μF | | | | | | | | | | | | | | | | 1.8 p74 | | | | | | | |
| 2.2μF | p74 | p74 | p74 | | | | | | | | | | | | | 1.9 p74 | | | | | | | |
| 4.7μF | p74 | p74 | p74 | | | | p74 | p74 | | | | | | | | | | | | | | | |
| 10μF | | | p74 | p74 | p74 | p74 | p74 | | p74 | p74 | | | | | | | | | | | | | |
| 22μF | | | | | | p74 | p74 | | p74 | p74 | p74 | p74 | p74 | | | 1.8 p74 | | | | | | | |
| 47μF | | | | | | | | | | | | | p74 | p74 | p74 | 1.8 p74 | 1.8 p74 | 1.8 p74 | 1.8 p74 | 1.8 p74 | | | |
| 100μF | | | | | | | | | | | | | | | | 1.9 p74 | 1.9 p74 | 1.9 p74 | 1.9 p74 | 1.9 p74 | p74 | | |
| 150μF | | | | | | | | | | | | | | | | | | | | | p75 | p75 | p75 |



Capacitance Table

p00

Each number in the Part Number List refers to the page number printed at the bottom of the page.

(→ ■ GRM Series High Dielectric Constant Type)

p00

← Part Number List

JIS:

R

B

EIA:

X7R

X7S

X7T

X7U

X6S

X6T

X5R

X5S

| LxW (mm) | 3.2x2.5 | | | | | | | | | | | | | | | | | | | | | | |
|---------------------|---------|------|------|------|-----|-----|-----|------|-----|------|-----|-----|-----|-----|--------|-----|--------|-----|-----|--------|-----|--|--|
| T max. (mm) | 1 | 1.5 | | | | | 1.8 | 2 | | | 2.2 | 2.7 | | | | | | | | | | | |
| Rated Voltage (Vdc) | 2.5 | 1000 | 630 | 250 | 50 | 10 | 100 | 1000 | 630 | 250 | 25 | 100 | 50 | 35 | 25 | | | 16 | | | | | |
| Cap. / TC Code | X6T | X7R | X7R | X7R | X7R | B | X6S | X7R | X7R | X7R | X7R | X6S | X7R | X7R | X5R, B | X7R | X5R, B | X7R | X6S | X5R, B | X7R | | |
| 68pF | | | | | | | | | | | | | | | | | | | | | | | |
| 100pF | | | | | | | | | | | | | | | | | | | | | | | |
| 150pF | | | | | | | | | | | | | | | | | | | | | | | |
| 220pF | | | | | | | | | | | | | | | | | | | | | | | |
| 330pF | | | | | | | | | | | | | | | | | | | | | | | |
| 470pF | | | | | | | | | | | | | | | | | | | | | | | |
| 680pF | | | | | | | | | | | | | | | | | | | | | | | |
| 1000pF | | | | | | | | | | | | | | | | | | | | | | | |
| 1500pF | | | | | | | | | | | | | | | | | | | | | | | |
| 2200pF | | | | | | | | | | | | | | | | | | | | | | | |
| 3300pF | | | | | | | | | | | | | | | | | | | | | | | |
| 4700pF | | | | | | | | | | | | | | | | | | | | | | | |
| 6800pF | | p144 | | | | | | | | | | | | | | | | | | | | | |
| 10000pF | | p144 | | | | | | | | | | | | | | | | | | | | | |
| 12000pF | | | | | | | | | | | | | | | | | | | | | | | |
| 15000pF | | | | | | | | | | p144 | | | | | | | | | | | | | |
| 18000pF | | | | | | | | | | | | | | | | | | | | | | | |
| 22000pF | | | p144 | | | | | | | p144 | | | | | | | | | | | | | |
| 27000pF | | | | | | | | | | | | | | | | | | | | | | | |
| 33000pF | | | | | | | | | | p144 | | | | | | | | | | | | | |
| 39000pF | | | | | | | | | | | | | | | | | | | | | | | |
| 47000pF | | | | | | | | | | p144 | | | | | | | | | | | | | |
| 68000pF | | | | p143 | | | | | | | | | | | | | | | | | | | |
| 0.1μF | | | | | | | | | | | | | | | | | | | | | | | |
| 0.15μF | | | | p143 | | | | | | | | | | | | | | | | | | | |
| 0.22μF | | | | | | | | | | | | | | | | | | | | | | | |
| 0.33μF | | | | | | | | | | | | | | | | | | | | | | | |
| 0.47μF | | | | | | | | | | | | | | | | | | | | | | | |
| 0.68μF | | | | | p75 | p75 | | | | p75 | | | | | | | | | | | | | |
| 1.0μF | | | | | | | | | | p75 | | | | | | | | | | | | | |
| 2.2μF | | | | | | | | | | | | | | | | | | | | | | | |
| 4.7μF | | | | | | | | | | | | | | | | | | | | | | | |
| 10μF | | | | | | | | | | | | | | | | | | | | | | | |
| 22μF | | | | | | | | | | | | | | | | | | | | | | | |
| 47μF | | | | | | | | | | | | | | | | | | | | | | | |
| 100μF | | | | | | | | | | | | | | | | | | | | | | | |
| 150μF | | p75 | | | | | | | | | | | | | | | | | | | | | |



Capacitance Table p00 Each number in the Part Number List refers to the page number printed at the bottom of the page.

(→ ■ GRM Series High Dielectric Constant Type)

p00 ← Part Number List JIS: R B EIA: X7R X7S X7T X7U X6S X6T X5R X5S

| LxW (mm) | 3.2x2.5 | | | | | | | | | 4.5x3.2 | | | | | 5.7x5.0 | | | | |
|---------------------|---------|--------|-----|-----|--------|-----|-----|--------|-----|---------|-----|-----|-----|------|---------|-----|------|-----|-----|
| T max. (mm) | 2.7 | | | | | | | | | 1.5 | | 2 | | | 2 | | | | |
| Rated Voltage (Vdc) | 16 | | | 10 | | | 6.3 | | | 4 | | 630 | 250 | 1000 | 630 | 250 | 1000 | 630 | 250 |
| Cap. / TC Code | X6S | X5R, B | X7R | X6S | X5R, B | X7Δ | X6S | X5R, B | X7U | X6S | X7R | X7R | X7R | X7R | X7R | X7R | X7R | X7R | X7R |
| 68pF | | | | | | | | | | | | | | | | | | | |
| 100pF | | | | | | | | | | | | | | | | | | | |
| 150pF | | | | | | | | | | | | | | | | | | | |
| 220pF | | | | | | | | | | | | | | | | | | | |
| 330pF | | | | | | | | | | | | | | | | | | | |
| 470pF | | | | | | | | | | | | | | | | | | | |
| 680pF | | | | | | | | | | | | | | | | | | | |
| 1000pF | | | | | | | | | | | | | | | | | | | |
| 1500pF | | | | | | | | | | | | | | | | | | | |
| 2200pF | | | | | | | | | | | | | | | | | | | |
| 3300pF | | | | | | | | | | | | | | | | | | | |
| 4700pF | | | | | | | | | | | | | | | | | | | |
| 6800pF | | | | | | | | | | | | | | | | | | | |
| 10000pF | | | | | | | | | | | | | | | | | | | |
| 12000pF | | | | | | | | | | | | | | | | | | | |
| 15000pF | | | | | | | | | | | | | | | | | | | |
| 18000pF | | | | | | | | | | | | | | | | | | | |
| 22000pF | | | | | | | | | | | | | | | | | | | |
| 27000pF | | | | | | | | | | | | | | | | | | | |
| 33000pF | | | | | | | | | | | | | | | | | | | |
| 39000pF | | | | | | | | | | | | | | | | | | | |
| 47000pF | | | | | | | | | | | | | | | | | | | |
| 68000pF | | | | | | | | | | | | | | | | | | | |
| 0.1μF | | | | | | | | | | | | | | | | | | | |
| 0.15μF | | | | | | | | | | | | | | | | | | | |
| 0.22μF | | | | | | | | | | | | | | | | | | | |
| 0.33μF | | | | | | | | | | | | | | | | | | | |
| 0.47μF | | | | | | | | | | | | | | | | | | | |
| 0.68μF | | | | | | | | | | | | | | | | | | | |
| 1.0μF | | | | | | | | | | | | | | | | | | | |
| 2.2μF | | | | | | | | | | | | | | | | | | | |
| 4.7μF | | | | | | | | | | | | | | | | | | | |
| 10μF | | | | | | | | | | | | | | | | | | | |
| 22μF | | | | | | | | | | | | | | | | | | | |
| 47μF | | | | | | | | | | | | | | | | | | | |
| 100μF | | | | | | | | | | | | | | | | | | | |
| 150μF | | | | | | | | | | | | | | | | | | | |

Capacitance Table

■ GNM Series High Dielectric Constant Type

p00 ← Part Number List JIS: R B EIA: X7R X5R

| Number of Elements | 2 | | | | | | | | | | | | | | | | | | | | | |
|---------------------|---------|-----|-----|-----|-----|-----|-----|-----|----------|-----|-----|-----|-----|---|-----|---|-----|---|-----|---|-----|---|
| LxW (mm) | 0.9x0.6 | | | | | | | | 1.37x1.0 | | | | | | | | | | | | | |
| T max. (mm) | 0.5 | | | | | | | | 0.55 | | | | | | 0.7 | | | | | | | |
| Rated Voltage (Vdc) | 16 | | 10 | | 4 | | 16 | | 10 | | 50 | | | | 25 | | | | 16 | | | |
| Cap. / TC Code | X5R | B | X5R | B | X5R | B | X7R | R | X5R | B | X5R | B | X7R | R | X5R | B | X7R | R | X5R | B | X7R | R |
| 470pF | | | | | | | | | | | | | | | | | | | | | | |
| 1000pF | | | | | | | | | | | | | | | | | | | | | | |
| 2200pF | | | | | | | | | | | | | | | | | | | | | | |
| 4700pF | | | | | | | | | | | | | | | | | | | | | | |
| 10000pF | p77 | p77 | p77 | p77 | | | | | | | | | | | | | | | | | | |
| 22000pF | p77 | p77 | p77 | p77 | | | | | | | | | | | | | | | | | | |
| 47000pF | p77 | p77 | p77 | p77 | | | | | | | | | | | | | | | | | | |
| 0.1μF | p77 | p77 | p77 | p77 | | | p77 | p77 | | p77 | | | | | | | | | | | | |
| 0.22μF | | | | | | | | | | | | | | | | | | | | | | |
| 0.47μF | | | | | | | | | | | | | | | | | | | | | | |
| 1.0μF | | | | | p77 | p77 | | | p77 | | p77 | p77 | | | | | | | | | | |
| 2.2μF | | | | | | | | | | | | | | | | | | | | | | |



| Number of Elements | 2 | | | | | | | | | | | | 4 | | | | | | | | | |
|---------------------|----------|-----|-----|-----|-----|-----|-----|-----|-----|-----|-----|---|----------|---|-----|-----|-----|-----|---|-----|---|---|
| LxW (mm) | 1.37x1.0 | | | | | | | | | | | | 2.0x1.25 | | | | | | | | | |
| T max. (mm) | 0.7 | | | | | | 0.8 | | | | | | 0.55 | | | | 0.7 | | | | | |
| Rated Voltage (Vdc) | 16 | | 10 | | 16 | | 10 | | 6.3 | | 16 | | 10 | | 6.3 | | 50 | | | | | |
| Cap. / TC Code | X5R | B | X7R | R | X5R | B | X5R | B | X5R | B | X5R | B | X7R | R | B | X5R | B | X5R | B | X7R | R | B |
| 470pF | | | | | | | | | | | | | | | | | | | | | | |
| 1000pF | | | | | | | | | | | | | | | | | | | | | | |
| 2200pF | | | | | | | | | | | | | | | | | | | | | | |
| 4700pF | | | | | | | | | | | | | | | | | | | | | | |
| 10000pF | | | | | | | | | | | | | | | | | | | | | | |
| 22000pF | p77 | p77 | p77 | p77 | p77 | p77 | | | | | | | | | | | | | | | | |
| 47000pF | p77 | p77 | p77 | p77 | p77 | p77 | | | | | | | | | | | | | | | | |
| 0.1μF | | p77 | | | | p77 | p77 | | | | | | | | | | | | | | | |
| 0.22μF | | | | | | | p77 | | | | | | | | | | | | | | | |
| 0.47μF | | | | | | | | | | | | | | | | | | | | | | |
| 1.0μF | | | | | | | | p77 | p77 | p77 | p77 | | | | | | | | | | | |
| 2.2μF | | | | | | | | | | | | | | | | | | | | | | |



| Number of Elements | 4 | | | | | | | | | |
|---------------------|----------|-----|-----|------|-----|-----|-----|-----|-----|-----|
| LxW (mm) | 2.0x1.25 | | | | | | | | | |
| T max. (mm) | 0.7 | | | 0.95 | | | | | | |
| Rated Voltage (Vdc) | 25 | | | 16 | | | 10 | | 6.3 | |
| Cap. / TC Code | X7R | R | B | X7R | R | B | X5R | B | X5R | B |
| 470pF | | | | | | | | | | |
| 1000pF | | | | | | | | | | |
| 2200pF | p77 | p77 | p77 | | | | | | | |
| 4700pF | p77 | p77 | p77 | | | | | | | |
| 10000pF | p77 | p77 | p78 | | | | | | | |
| 22000pF | | | | p78 | p78 | p78 | | | | |
| 47000pF | | | | p78 | p78 | p78 | | | | |
| 0.1μF | | | | p78 | p78 | p78 | | | | |
| 0.22μF | | | | | | | | | | |
| 0.47μF | | | | | | | | | | |
| 1.0μF | | | | | | | p78 | p78 | p78 | p78 |
| 2.2μF | | | | | | | | | | |

Capacitance Table

■ LLL Series High Dielectric Constant Type

p00 ← Part Number List EIA: X7R X7S X6S X5R

| LxW (mm) | 0.5x1.0 | | | | 0.8x1.6 | | | | | | | | 1.25x2.0 | | | | | | | | | | |
|---------------------|---------|-----|-----|-----|---------|-----|------|-----|-----|-----|-----|-----|----------|-----|-----|-----|-----|-----|-----|------|-----|-----|--|
| T max. (mm) | 0.35 | | 0.5 | | | | 0.55 | 0.6 | | | | 0.5 | | | | 0.7 | | | | 0.95 | | | |
| Rated Voltage (Vdc) | 6.3 | 4 | 25 | 16 | 10 | 4 | 4 | 50 | 25 | 16 | 10 | 4 | 50 | 25 | 16 | 10 | 6.3 | 4 | 50 | 25 | 10 | 16 | |
| Cap. / TC Code | X6S | X7S | X7R | X7R | X7R | X7S | X7S | X7R | X7R | X7R | X7R | X7S | X7R | X7R | X7R | X7R | X7R | X7S | X7R | X7R | X7R | X7R | |
| 2200pF | | | | | | | | p80 | | | | | | | | | | | | | | | |
| 4700pF | | | | | | | | p80 | | | | | | | | | | | | | | | |
| 10000pF | | | p80 | | | | | | p80 | | | | | p80 | | | | | | | p80 | | |
| 22000pF | | | | p80 | | | | | p80 | | | | | p80 | | | | | | | p80 | | |
| 47000pF | | | | p80 | | | | | | p80 | | | | | p80 | | | | | | p80 | | |
| 0.1μF | p80 | | | | p80 | | | | | | p80 | | | | p80 | | | | | | p80 | | |
| 0.22μF | p80 | | | | | p80 | | | | | | p80 | | | | p80 | | | | | p80 | p80 | |
| 0.47μF | | p80 | | | | | | | | | | p80 | | | | | p80 | | | | | | |
| 1.0μF | | | | | | | p80 | | | | | | | | | | p80 | | | | | | |
| 2.2μF | | | | | | | p80 | | | | | | | | | | | | | | | | |
| 4.7μF | | | | | | | | | | | | | | | | | | | | | | | |
| 10μF | | | | | | | | | | | | | | | | | | | | | | | |



| LxW (mm) | 1.25x2.0 | | 1.6x3.2 | | | | | | | | | | | | | | | | | |
|---------------------|----------|-----|---------|-----|-----|-----|-----|-----|-----|-----|-----|-----|-----|-----|------|-----|-----|--|--|--|
| T max. (mm) | 0.95 | | 0.5 | | | | | | 0.8 | | | | | | 1.25 | | | | | |
| Rated Voltage (Vdc) | 10 | 4 | 50 | 25 | 16 | 10 | 50 | 25 | 16 | 10 | 6.3 | 50 | 25 | 16 | 10 | 6.3 | | | | |
| Cap. / TC Code | X7R | X7S | X7R | X7R | X7R | X7R | X7R | X7R | X7R | X7R | X7R | X7R | X7R | X7R | X7R | X7R | X5R | | | |
| 2200pF | | | | | | | | | | | | | | | | | | | | |
| 4700pF | | | | | | | | | | | | | | | | | | | | |
| 10000pF | | | p80 | | | | | p80 | | | | | | | | | | | | |
| 22000pF | | | p80 | | | | | p80 | | | | | | | | | | | | |
| 47000pF | | | | p80 | | | | p80 | | | | | | | | | | | | |
| 0.1μF | | | | p80 | | | | p80 | | | | | p80 | | | | | | | |
| 0.22μF | | | | | p80 | | | | p80 | | | | | p80 | | | | | | |
| 0.47μF | p80 | | | | | p80 | | | | p80 | | | | p80 | | | | | | |
| 1.0μF | p80 | | | | | | | | | p80 | | | | p80 | | | | | | |
| 2.2μF | | p80 | | | | | | | | | p80 | | | | p80 | | | | | |
| 4.7μF | | | | | | | | | | | | | | | | p80 | | | | |
| 10μF | | | | | | | | | | | | | | | | | p80 | | | |

■ LLR Series High Dielectric Constant Type

p00 ← Part Number List EIA: X7S

| | | | | |
|---------------------|---------|-----|-----|------|
| LxW (mm) | 0.8x1.6 | | | |
| T max. (mm) | 0.55 | | | |
| Rated Voltage (Vdc) | 4 | | | |
| TC Code | X7S | | | |
| Cap. / ESR (mΩ) | 100 | 220 | 470 | 1000 |
| 1.0μF | p80 | p80 | p80 | p80 |

Capacitance Table

■ LLA Series High Dielectric Constant Type

p00 ← Part Number List EIA: X7R X7S

| L×W (mm) | 1.6× 0.8 | 2.0×1.25 | | | | | | | | | | 3.2×1.6 | | | | | | |
|---------------------|-------------|----------|-----|-----|-----|-----|------|-----|-----|-----|-----|---------|-----|-----|------|-----|------|-----|
| | | 0.55 | | | | | 0.95 | | | | | 0.55 | | | 0.95 | | 1.25 | |
| T max. (mm) | 0.55 | | | | | | | | | | | | | | | | | |
| Rated Voltage (Vdc) | 4 | 25 | 16 | 10 | 6.3 | 4 | 25 | 16 | 10 | 6.3 | 4 | 16 | 10 | 6.3 | 16 | 10 | 16 | 10 |
| Cap. / TC Code | X7S | X7R | X7R | X7R | X7R | X7S | X7R | X7R | X7R | X7R | X7S | X7R | X7R | X7R | X7R | X7R | X7R | X7R |
| 10000pF | | p81 | | | | | p81 | | | | | | | | | | | |
| 22000pF | | p81 | | | | | p81 | | | | | | | | | | | |
| 47000pF | | | p81 | | | | p81 | | | | | | | | | | | |
| 0.1μF | p81 | | p81 | | | | | p81 | | | | | | | | | | |
| 0.22μF | p81 | | | p81 | | | | p81 | | | | p81 | | | | | | |
| 0.47μF | p81 | | | | p81 | | | | p81 | | | | p81 | | p81 | | | |
| 1.0μF | p81 | | | | | p81 | | | | p81 | | | | p81 | | p81 | p81 | |
| 2.2μF | p81 | | | | | | p81 | | | | p81 | | | p81 | | | | p81 |
| 4.7μF | | | | | | p81 | | | | | p81 | | | | | | | |

■ LLM Series High Dielectric Constant Type

p00 ← Part Number List EIA: X7R X7S

| L×W (mm) | 2.0×1.25 | | | | 3.2×1.6 | | |
|---------------------|----------|-----|-----|-----|---------|-----|-----|
| | 0.55 | | | | 0.55 | | |
| Rated Voltage (Vdc) | 25 | 16 | 6.3 | 4 | 16 | 10 | 6.3 |
| Cap. / TC Code | X7R | X7R | X7R | X7S | X7R | X7R | X7R |
| 10000pF | p81 | | | | | | |
| 22000pF | p81 | | | | | | |
| 47000pF | | p81 | | | | | |
| 0.1μF | | p81 | | p81 | | | |
| 0.22μF | | | p81 | | p81 | | |
| 0.47μF | | | p81 | | | p81 | |
| 1.0μF | | | | p81 | | | |
| 2.2μF | | | | p81 | | | p81 |

Capacitance Table

■ GJM Series Temperature Compensating Type

p00 ← Part Number List JIS: CK CJ CH EIA: C0G C0H

| LxW (mm) | 0.4x0.2 | | 0.6x0.3 | | | | 1.0x0.5 | |
|---------------------|---------|-----|---------|-----|-----|-----|---------|------|
| T max. (mm) | 0.22 | | 0.33 | | | | 0.55 | |
| Rated Voltage (Vdc) | 16 | | 25 | | 6.3 | | 50 | |
| Cap. / TC Code | C0G | CΔ | C0Δ | CΔ | C0G | CH | C0G | CΔ |
| 0.1pF | | | | | | | p96 | p99 |
| 0.2pF | p83 | p86 | p89 | p92 | | | p96 | p99 |
| 1.0pF | p83 | p86 | p89 | p92 | | | p96 | p99 |
| 2.0pF | p83 | p86 | p89 | p92 | | | p96 | p99 |
| 3.0pF | p83 | p86 | p90 | p93 | | | p96 | p100 |
| 4.0pF | p84 | p87 | p90 | p93 | | | p97 | p100 |
| 5.0pF | p84 | p87 | p90 | p93 | | | p97 | p100 |
| 6.0pF | p84 | p87 | p90 | p94 | | | p97 | p101 |
| 7.0pF | p85 | p88 | p91 | p94 | | | p98 | p101 |
| 8.0pF | p85 | p88 | p91 | p94 | | | p98 | p101 |
| 9.0pF | p85 | p88 | p92 | p95 | | | p98 | p102 |
| 10pF | p86 | p89 | p92 | p95 | | | p99 | p102 |
| 11pF | | | p92 | p95 | | | p99 | p102 |
| 12pF | | | p92 | p95 | | | p99 | p102 |
| 13pF | | | p92 | p95 | | | p99 | p102 |
| 15pF | | | p92 | p95 | | | p99 | p102 |
| 16pF | | | p92 | p95 | | | p99 | p102 |
| 18pF | | | p92 | p95 | | | p99 | p102 |
| 20pF | | | p92 | p95 | | | p99 | p102 |
| 22pF | | | | | p95 | p95 | p99 | p102 |
| 24pF | | | | | p95 | p95 | p99 | p102 |
| 27pF | | | | | p95 | p95 | p99 | p102 |
| 30pF | | | | | p95 | p95 | p99 | p102 |
| 33pF | | | | | p95 | p95 | p99 | p102 |
| 36pF | | | | | | | p99 | p102 |
| 39pF | | | | | | | p99 | p102 |
| 43pF | | | | | | | p99 | p103 |
| 47pF | | | | | | | p99 | p103 |

The indication for every 0.1 pF has been omitted for less than 10 pF. Refer to the Part Number List for details.

Capacitance Table

■ GQM Series Temperature Compensating Type

p00 ← Part Number List JIS: **CK** **CJ** **CH** EIA: **C0G**

| LxW (mm) | 1.6x0.8 | | | | | 2.0x1.25 | | | | | 2.8x2.8 |
|---------------------|---------|------|------|------|------|----------|------|------|------|------|---------|
| T max. (mm) | 0.8 | 0.9 | | | | 0.95 | | | | 1 | 1.35 |
| Rated Voltage (Vdc) | 250 | 100 | 50 | | | 100 | 50 | | | 250 | 500 |
| Cap. / TC Code | C0G | C0G | CΔ | C0G | CH | C0G | CΔ | C0G | CH | C0G | C0G |
| 0.1pF | p105 | | | | | | | | | | |
| 0.5pF | p105 | p105 | p106 | | | p108 | p108 | | | p110 | p111 |
| 1.0pF | p105 | p106 | p106 | | | p108 | p108 | | | p110 | p111 |
| 2.0pF | p105 | p106 | p106 | | | p108 | p109 | | | p110 | p111 |
| 3.0pF | p105 | p106 | p106 | | | p108 | p109 | | | p110 | p111 |
| 4.0pF | p105 | p106 | p106 | | | p108 | p109 | | | p110 | p111 |
| 5.0pF | p105 | p106 | p106 | | | p108 | p109 | | | p110 | p111 |
| 6.0pF | p105 | p106 | p106 | | | p108 | p109 | | | p110 | p111 |
| 7.0pF | p105 | | | p106 | p107 | p108 | p109 | | | p110 | p111 |
| 8.0pF | p105 | | | p106 | p107 | p108 | p109 | | | p110 | p111 |
| 9.0pF | p105 | | | p107 | p107 | p108 | p109 | | | p110 | p111 |
| 10pF | p105 | | | p107 | p107 | p108 | p109 | | | p110 | p111 |
| 11pF | p105 | | | p107 | p107 | p108 | p109 | | | p110 | p111 |
| 12pF | p105 | | | p107 | p107 | p108 | p109 | | | p110 | p111 |
| 13pF | p105 | | | p107 | p107 | p108 | p109 | | | p110 | p112 |
| 15pF | p105 | | | p107 | p107 | p108 | p109 | | | p110 | p112 |
| 16pF | p105 | | | p107 | p107 | p108 | p109 | | | p110 | p112 |
| 18pF | p105 | | | p107 | p107 | p108 | p109 | | | p110 | p112 |
| 20pF | p105 | | | p107 | p107 | | | p109 | p109 | p110 | p112 |
| 22pF | p105 | | | p107 | p107 | | | p109 | p109 | p110 | p112 |
| 24pF | p105 | | | p107 | p107 | | | p109 | p109 | p111 | p112 |
| 27pF | p105 | | | p107 | p107 | | | p109 | p109 | p111 | p112 |
| 30pF | p105 | | | p107 | p107 | | | p109 | p109 | p111 | p112 |
| 33pF | p105 | | | p107 | p107 | | | p109 | p110 | p111 | p112 |
| 36pF | p105 | | | p107 | p107 | | | p109 | p110 | p111 | p112 |
| 39pF | p105 | | | p107 | p107 | | | p109 | p110 | p111 | p112 |
| 43pF | p105 | | | p107 | p107 | | | p109 | p110 | p111 | p112 |
| 47pF | p105 | | | p107 | p107 | | | p109 | p110 | p111 | p112 |
| 51pF | | | | p107 | p107 | | | p109 | p110 | p111 | p112 |
| 56pF | | | | p107 | p107 | | | p109 | p110 | p111 | p112 |
| 62pF | | | | p107 | p107 | | | p109 | p110 | p111 | p112 |
| 68pF | | | | p107 | p108 | | | p109 | p110 | p111 | p112 |
| 75pF | | | | p107 | p108 | | | p109 | p110 | p111 | p112 |
| 82pF | | | | p107 | p108 | | | p109 | p110 | p111 | p112 |
| 91pF | | | | p107 | p108 | | | p109 | p110 | p111 | p112 |
| 100pF | | | | p107 | p108 | | | p109 | p110 | p111 | p112 |

The indication for every 0.1 pF has been omitted for less than 10 pF. Refer to the Part Number List for details.

Capacitance Table

■ GMA Series High Dielectric Constant Type

p00 ← Part Number List JIS: R B EIA: X7R X5R

| LxW (mm) | 0.38x0.38 | | 0.5x0.5 | | | | | | | | 0.8x0.8 | | | | | | | |
|---------------------|-----------|------|---------|------|------|------|------|------|------|------|---------|------|------|------|------|------|------|------|
| T max. (mm) | 0.35 | | 0.4 | | | | | | | | 0.6 | | | | | | | |
| Rated Voltage (Vdc) | 10 | | 100 | 25 | | 10 | | | 6.3 | | 100 | 25 | | 10 | | | 6.3 | |
| Cap. / TC Code | X7R | R | X7R | X7R | B | X7R | R | B | X5R | B | X7R | X7R | B | X7R | R | B | X5R | B |
| 100pF | | | p114 | | | | | | | | | | | | | | | |
| 150pF | | | p114 | | | | | | | | | | | | | | | |
| 220pF | | | p114 | | | | | | | | | | | | | | | |
| 330pF | | | p114 | | | | | | | | | | | | | | | |
| 470pF | | | p114 | | | | | | | | | | | | | | | |
| 680pF | | | p114 | | | | | | | | | | | | | | | |
| 1000pF | | | p114 | | | | | | | | | | | | | | | |
| 1500pF | | | | p114 | p114 | | | | | | p114 | | | | | | | |
| 2200pF | | | | p114 | p114 | | | | | | p114 | | | | | | | |
| 3300pF | | | | p114 | p114 | | | | | | p114 | | | | | | | |
| 4700pF | | | | p114 | p114 | | | | | | p114 | | | | | | | |
| 6800pF | | | | | | p114 | p114 | p114 | | | p114 | | | | | | | |
| 10000pF | p114 | p114 | | | | p114 | p114 | p114 | | | | p114 | p114 | | | | | |
| 15000pF | | | | | | p114 | p114 | p114 | | | | p114 | p114 | | | | | |
| 22000pF | | | | | | p114 | p114 | p114 | | | | p114 | p114 | | | | | |
| 33000pF | | | | | | | | | | | | | | p114 | p114 | p114 | | |
| 47000pF | | | | | | | | | | | | | | p114 | p114 | p114 | | |
| 68000pF | | | | | | | | | | | | | | p114 | p114 | p114 | | |
| 0.1μF | | | | | | | | | p114 | p114 | | | | p114 | p114 | p114 | | |
| 0.47μF | | | | | | | | | | | | | | | | | p114 | p114 |

Capacitance Table

■ GMD Series High Dielectric Constant Type

ρ00 ← Part Number List JIS: R B EIA: X7R X5R

| LxW (mm) | 0.6x0.3 | | | | | | | | | | 1.0x0.5 | | | | | | | | | | | | |
|---------------------|---------|------|------|------|------|------|------|------|------|------|---------|------|------|------|------|------|------|------|------|------|------|------|--|
| | 0.33 | | | | | | | | | | 0.55 | | | | | | | | | | | | |
| T max. (mm) | 0.33 | | | | | | | | | | 0.55 | | | | | | | | | | | | |
| Rated Voltage (Vdc) | 25 | | | 16 | | | 10 | | | 6.3 | | 50 | | | 25 | | | 16 | | | 10 | | |
| Cap. / TC Code | X7R | R | B | X7R | R | B | X7R | R | B | X5R | B | X7R | R | B | X7R | R | B | X7R | R | B | X5R | B | |
| 100pF | p116 | p116 | p116 | | | | | | | | | | | | | | | | | | | | |
| 120pF | p116 | p116 | p116 | | | | | | | | | | | | | | | | | | | | |
| 150pF | p116 | p116 | p116 | | | | | | | | | | | | | | | | | | | | |
| 180pF | p116 | p116 | p116 | | | | | | | | | | | | | | | | | | | | |
| 220pF | p116 | p116 | p116 | | | | | | | | | p116 | p116 | p117 | | | | | | | | | |
| 270pF | p116 | p116 | p116 | | | | | | | | | p116 | p117 | p117 | | | | | | | | | |
| 330pF | p116 | p116 | p116 | | | | | | | | | p116 | p117 | p117 | | | | | | | | | |
| 390pF | p116 | p116 | p116 | | | | | | | | | p116 | p117 | p117 | | | | | | | | | |
| 470pF | p116 | p116 | p116 | | | | | | | | | p116 | p117 | p117 | | | | | | | | | |
| 560pF | p116 | p116 | p116 | | | | | | | | | p116 | p117 | p117 | | | | | | | | | |
| 680pF | p116 | p116 | p116 | | | | | | | | | p116 | p117 | p117 | | | | | | | | | |
| 820pF | p116 | p116 | p116 | | | | | | | | | p116 | p117 | p117 | | | | | | | | | |
| 1000pF | p116 | p116 | p116 | | | | | | | | | p116 | p117 | p117 | | | | | | | | | |
| 1200pF | p116 | p116 | p116 | | | | | | | | | p116 | p117 | p117 | | | | | | | | | |
| 1500pF | p116 | p116 | p116 | | | | | | | | | p116 | p117 | p117 | | | | | | | | | |
| 1800pF | | | | p116 | p116 | p116 | | | | | | p116 | p117 | p117 | | | | | | | | | |
| 2200pF | | | | p116 | p116 | p116 | | | | | | p116 | p117 | p117 | | | | | | | | | |
| 2700pF | | | | p116 | p116 | p116 | | | | | | p116 | p117 | p117 | | | | | | | | | |
| 3300pF | | | | p116 | p116 | p116 | | | | | | p116 | p117 | p117 | | | | | | | | | |
| 3900pF | | | | | | | p116 | p116 | p116 | | | p116 | p117 | p117 | | | | | | | | | |
| 4700pF | | | | | | | p116 | p116 | p116 | | | p116 | p117 | p117 | | | | | | | | | |
| 5600pF | | | | | | | p116 | p116 | p116 | | | | | | p117 | p117 | p117 | | | | | | |
| 6800pF | | | | | | | p116 | p116 | p116 | | | | | | p117 | p117 | p117 | | | | | | |
| 8200pF | | | | | | | p116 | p116 | p116 | | | | | | p117 | p117 | p117 | | | | | | |
| 10000pF | | | | | | | p116 | p116 | p116 | | | | | | p117 | p117 | p117 | | | | | | |
| 12000pF | | | | | | | | | | | | | | | p117 | p117 | p117 | | | | | | |
| 15000pF | | | | | | | | | | | | | | | p117 | p117 | p117 | | | | | | |
| 18000pF | | | | | | | | | | | | | | | p117 | p117 | p117 | | | | | | |
| 22000pF | | | | | | | | | | | | | | | p117 | p117 | p117 | | | | | | |
| 27000pF | | | | | | | | | | | | | | | p117 | p117 | p117 | | | | | | |
| 33000pF | | | | | | | | | | | | | | | p117 | p117 | p117 | | | | | | |
| 39000pF | | | | | | | | | | | | | | | p117 | p117 | p117 | | | | | | |
| 47000pF | | | | | | | | | | | | | | | p117 | p117 | p117 | | | | | | |
| 56000pF | | | | | | | | | | p116 | p116 | | | | | | | p117 | p117 | p117 | | | |
| 68000pF | | | | | | | | | | p116 | p116 | | | | | | | p117 | p117 | p117 | | | |
| 82000pF | | | | | | | | | | p116 | p116 | | | | | | | p117 | p117 | p117 | | | |
| 0.1μF | | | | | | | | | | p116 | p116 | | | | | | | p117 | p117 | p117 | | | |
| 0.12μF | | | | | | | | | | | | | | | | | | | | | p117 | p117 | |
| 0.15μF | | | | | | | | | | | | | | | | | | | | | p117 | p117 | |
| 0.18μF | | | | | | | | | | | | | | | | | | | | | p117 | p117 | |
| 0.22μF | | | | | | | | | | | | | | | | | | | | | p117 | p117 | |
| 0.27μF | | | | | | | | | | | | | | | | | | | | | p117 | p117 | |
| 0.33μF | | | | | | | | | | | | | | | | | | | | | p117 | p117 | |
| 0.39μF | | | | | | | | | | | | | | | | | | | | | p117 | p117 | |
| 0.47μF | | | | | | | | | | | | | | | | | | | | | p117 | p117 | |

Capacitance Table

■ GRJ Series High Dielectric Constant Type

p00 ← Part Number List EIA: X7R

| LxW (mm) | 2.0x1.25 | | 3.2x1.6 | | | | | | 3.2x2.5 | | | | | | 4.5x3.2 | | | | 5.7x5.0 | | | |
|---------------------|-------------|------|---------|------|------|------|------|------|---------|------|------|------|------|------|---------|------|------|-----|---------|------|------|------|
| | T max. (mm) | 1 | 1.45 | 1.25 | | | 1.8 | | | 1.5 | | | 2 | | | 1.5 | | 2 | | 2 | | |
| Rated Voltage (Vdc) | 250 | 250 | 1000 | 630 | 250 | 1000 | 630 | 250 | 1000 | 630 | 250 | 1000 | 630 | 250 | 630 | 250 | 1000 | 630 | 250 | 1000 | 630 | 250 |
| Cap. / TC Code | X7R | X7R | X7R | X7R | X7R | X7R | X7R | X7R | X7R | X7R | X7R | X7R | X7R | X7R | X7R | X7R | X7R | X7R | X7R | X7R | X7R | X7R |
| 470pF | | | p149 | | | | | | | | | | | | | | | | | | | |
| 680pF | | | p149 | | | | | | | | | | | | | | | | | | | |
| 1000pF | p148 | | p149 | p149 | | | | | | | | | | | | | | | | | | |
| 1500pF | p148 | | p149 | p149 | | | | | | | | | | | | | | | | | | |
| 2200pF | p148 | | p149 | p149 | | | | | | | | | | | | | | | | | | |
| 3300pF | p148 | | p149 | p149 | | | | | | | | | | | | | | | | | | |
| 4700pF | p148 | | p149 | p149 | | | | | | | | | | | | | | | | | | |
| 6800pF | p148 | | | p149 | | p149 | | | | p149 | | | | | | | | | | | | |
| 10000pF | | p148 | | p149 | | p149 | | | | p149 | | | | | | | | | | | | |
| 15000pF | | p148 | | | p148 | | p149 | | | | | p149 | | | | | | | | | | |
| 22000pF | | p148 | | | p148 | | p149 | | | | p149 | | p149 | | | | | | | | | |
| 33000pF | | | | | | | | p148 | | | | | p149 | | | | p149 | | | | | |
| 47000pF | | | | | | | | p148 | | | | | p149 | | | | p149 | | | | | |
| 68000pF | | | | | p148 | | | | | | p148 | | | | p149 | | | | | | p149 | |
| 0.1μF | | | | | | | | p148 | | | | | | p148 | | | p149 | | | | p149 | |
| 0.15μF | | | | | | | | | | | p148 | | | | | p148 | | | | | | p149 |
| 0.22μF | | | | | | | | | | | | | | p148 | | | | | | p148 | | p149 |
| 0.33μF | | | | | | | | | | | | | | | | | | | p148 | | | p148 |
| 0.47μF | | | | | | | | | | | | | | | | | | | p148 | | | p148 |
| 0.68μF | | | | | | | | | | | | | | | | | | | | | | p148 |
| 1.0μF | | | | | | | | | | | | | | | | | | | | | | p148 |

■ GR3 Series High Dielectric Constant Type

p00 ← Part Number List EIA: X7T

| LxW (mm) | 2.0x1.25 | | 3.2x1.6 | | | | | | 3.2x2.5 | | | | | | 4.5x3.2 | | | | 5.7x5.0 | | | | | |
|---------------------|-------------|------|---------|------|------|-----|------|-----|---------|------|-----|------|------|------|---------|------|------|------|---------|------|------|------|------|------|
| | T max. (mm) | 1 | 1.45 | 1 | 1.25 | | | 1.8 | | | 1.5 | | | 2 | | | 1.5 | | 2 | | 2 | | | |
| Rated Voltage (Vdc) | 250 | 250 | 450 | 250 | 630 | 450 | 250 | 630 | 450 | 250 | 630 | 250 | 630 | 450 | 250 | 630 | 450 | 250 | 630 | 450 | 250 | 630 | 450 | 250 |
| Cap. / TC Code | X7T | X7T | X7T | X7T | X7T | X7T | X7T | X7T | X7T | X7T | X7T | X7T | X7T | X7T | X7T | X7T | X7T | X7T | X7T | X7T | X7T | X7T | X7T | X7T |
| 10000pF | p153 | | p153 | | p154 | | | | | | | | | | | | | | | | | | | |
| 15000pF | p153 | | p153 | | | | p154 | | | | | | | | | | | | | | | | | |
| 22000pF | | p153 | | | p153 | | | | | p154 | | | | | | | | | | | | | | |
| 33000pF | | | | p153 | p153 | | | | | | | p154 | | | | | | | | | | | | |
| 47000pF | | | | | p153 | | p153 | | | | | | p154 | | | | | | | | | | | |
| 68000pF | | | | | | | p153 | | | | | | | p153 | | | p154 | | | | | | | |
| 0.1μF | | | | | | | | | | p153 | | | | p153 | | | | | p154 | | | | | |
| 0.15μF | | | | | | | | | | | | | | p153 | | | p153 | | p154 | | | | | |
| 0.22μF | | | | | | | | | | | | | | | | p153 | | | | p153 | | p154 | | |
| 0.27μF | | | | | | | | | | | | | | | | | | | | | p153 | | p154 | |
| 0.33μF | | | | | | | | | | | | | | | | | | p153 | | | p153 | | | |
| 0.47μF | | | | | | | | | | | | | | | | | | | | p153 | p153 | | | |
| 0.56μF | | | | | | | | | | | | | | | | | | | | | | | | p153 |
| 0.68μF | | | | | | | | | | | | | | | | | | | | | p153 | | | |
| 1.0μF | | | | | | | | | | | | | | | | | | | | | | | | p153 |

Capacitance Table

■ GRM/DC3.15kV Series High Dielectric Constant Type

p00 ← Part Number List EIA: C0G

| LxW (mm) | 4.5x 2.0 |
|---------------------|-------------|
| T max. (mm) | 1 |
| Rated Voltage (Vdc) | 3150 |
| Cap. / TC Code | C0G |
| 5.0pF | p158 |
| 10pF | p158 |
| 12pF | p158 |
| 15pF | p158 |
| 18pF | p158 |
| 22pF | p158 |
| 27pF | p158 |
| 33pF | p158 |
| 39pF | p158 |
| 47pF | p158 |

■ GR4 Series High Dielectric Constant Type

p00 ← Part Number List EIA: X7R

| LxW (mm) | 4.5x 2.0 | 4.5x3.2 | | 5.7x 5.0 |
|---------------------|-------------|---------|------|-------------|
| T max. (mm) | 1.5 | 1.5 | 2 | 2 |
| Rated Voltage (Vdc) | 2000 | 2000 | 2000 | 2000 |
| Cap. / TC Code | X7R | X7R | X7R | X7R |
| 100pF | p161 | | | |
| 120pF | p161 | | | |
| 150pF | p161 | | | |
| 180pF | p161 | | | |
| 220pF | p161 | | | |
| 270pF | p161 | | | |
| 330pF | p161 | | | |
| 390pF | p161 | | | |
| 470pF | p161 | | | |
| 560pF | p161 | | | |
| 680pF | p161 | | | |
| 820pF | p161 | | | |
| 1000pF | p161 | | | |
| 1200pF | p161 | | | |
| 1500pF | p161 | | | |
| 1800pF | | p161 | | |
| 2200pF | | p161 | | |
| 2700pF | | p161 | | |
| 3300pF | | p161 | | |
| 3900pF | | p161 | | |
| 4700pF | | | p161 | |
| 10000pF | | | | p161 |

■ GR7 Series

p00 ← Part Number List Murata Temperature Characteristic: -

| LxW (mm) | 2.0x1.25 | | 3.2x1.6 | | |
|---------------------|----------|------|---------|------|------|
| T max. (mm) | 1 | 1.45 | 1 | 1.25 | 1.8 |
| Rated Voltage (Vdc) | 350 | 350 | 350 | 350 | 350 |
| Cap. / TC Code | - | - | - | - | - |
| 10000pF | p165 | | p165 | | |
| 15000pF | p165 | | p165 | | |
| 22000pF | | p165 | p165 | p165 | |
| 27000pF | | p165 | p165 | | |
| 33000pF | | | p165 | p165 | |
| 47000pF | | | | | p165 |

■ GA2 Series High Dielectric Constant Type

p00 ← Part Number List EIA: X7R

| LxW (mm) | 4.5x 2.0 | 4.5x3.2 | | 5.7x 5.0 |
|-----------------------------|-------------|---------|------|-------------|
| T max. (mm) | 1.5 | 1.5 | 2 | 2 |
| Rated Voltage (Vac(r.m.s.)) | 250 | 250 | 250 | 250 |
| Cap. / TC Code | X7R | X7R | X7R | X7R |
| 470pF | p169 | | | |
| 1000pF | p169 | | | |
| 2200pF | | p169 | | |
| 3300pF | | p169 | | |
| 4700pF | | | p169 | |
| 10000pF | | p169 | | |
| 22000pF | | p169 | | |
| 47000pF | | | p169 | |
| 0.1μF | | | | p169 |

Capacitance Table

GA3 Series UL, IEC60384-14 Class X1/Y2 Type GC High Dielectric Constant Type

ρ00 ← Part Number List EIA: X7R

| L×W (mm) | 5.7×5.0 |
|-----------------------------|---------|
| T max. (mm) | 2.3 |
| Rated Voltage (Vac(r.m.s.)) | 250 |
| Cap. / TC Code | X7R |
| 100pF | p173 |
| 150pF | p173 |
| 220pF | p173 |
| 330pF | p173 |

GA3 Series IEC60384-14 Class Y2, X1/Y2 Type GF

ρ00 ← Part Number List JIS: SL EIA: X7R

| L×W (mm) | 4.5×2.0 | | | 5.7×2.8 | 5.7×5.0 | |
|-----------------------------|---------|------|------|---------|---------|------|
| | 1 | 1.5 | 2.2 | 1.5 | 1.5 | 2 |
| Rated Voltage (Vac(r.m.s.)) | 250 | 250 | 250 | 250 | 250 | 250 |
| Cap. / TC Code | SL | X7R | SL | X7R | X7R | X7R |
| 10pF | | | p174 | | | |
| 12pF | | | p174 | | | |
| 15pF | | | p174 | | | |
| 18pF | | | p174 | | | |
| 22pF | | | p174 | | | |
| 27pF | p174 | | | | | |
| 33pF | p174 | | | | | |
| 39pF | p174 | | | | | |
| 47pF | p174 | | | | | |
| 56pF | p174 | | | | | |
| 68pF | p174 | | | | | |
| 82pF | p174 | | | | | |
| 100pF | | p174 | | | | |
| 150pF | | p174 | | | | |
| 220pF | | | p174 | | | |
| 330pF | | | p174 | | | |
| 470pF | | p174 | | p174 | | |
| 680pF | | p174 | | p174 | | |
| 1000pF | | | p174 | p174 | | |
| 1500pF | | | | p175 | | |
| 1800pF | | | | | p175 | |
| 2200pF | | | | | p175 | |
| 3300pF | | | | | | p175 |
| 4700pF | | | | | | p175 |

GA3 Series IEC60384-14 Class Y3 Type GD

ρ00 ← Part Number List JIS: SL EIA: X7R

| L×W (mm) | 4.5×2.0 | | | 4.5×3.2 | |
|-----------------------------|---------|------|------|---------|------|
| | 1 | 1.5 | 2.2 | 1.5 | 2 |
| Rated Voltage (Vac(r.m.s.)) | 250 | 250 | 250 | 250 | 250 |
| Cap. / TC Code | SL | X7R | SL | X7R | X7R |
| 10pF | | | p176 | | |
| 12pF | | | p176 | | |
| 15pF | | | p176 | | |
| 18pF | | | p176 | | |
| 22pF | | | p176 | | |
| 27pF | p176 | | | | |
| 33pF | p176 | | | | |
| 39pF | p176 | | | | |
| 47pF | p176 | | | | |
| 56pF | p176 | | | | |
| 68pF | p176 | | | | |
| 82pF | p176 | | | | |
| 100pF | | p176 | | | |
| 150pF | | p176 | | | |
| 220pF | | p176 | | | |
| 330pF | | p176 | | | |
| 470pF | | p176 | | | |
| 680pF | | p176 | | | |
| 1000pF | | p176 | | | |
| 1500pF | | p176 | | | |
| 1800pF | | | | p176 | |
| 2200pF | | | | p176 | |
| 4700pF | | | | | p176 |

GA3 Series IEC60384-14 Class X2 Type GB High Dielectric Constant Type

ρ00 ← Part Number List EIA: X7R

| L×W (mm) | 5.7×5.0 | | | |
|-----------------------------|---------|------|------|------|
| | 1.5 | 2 | 2.5 | 2.9 |
| Rated Voltage (Vac(r.m.s.)) | 250 | 250 | 250 | 250 |
| Cap. / TC Code | X7R | X7R | X7R | X7R |
| 10000pF | p177 | | | |
| 15000pF | p177 | | | |
| 22000pF | | p177 | | |
| 33000pF | | | p177 | |
| 47000pF | | | p177 | |
| 56000pF | | | | p177 |

Capacitance Table

■ KRM Series High Dielectric Constant Type

p00 ← Part Number List EIA: X7R X6S X5R

| LxW (mm) | 3.5x1.7 | | | | | | 6.1x5.3 | | | | | | | | | | | | | | |
|---------------------|---------|------|------|------|------|------|---------|------|------|------|------|------|------|------|------|-----|-----|------|------|------|------|
| | 2 | | 2.9 | | 2.9 | 2.9 | 3 | | | | 3.9 | | | | 5 | | 6.7 | | | | |
| T max. (mm) | 2 | | 2.9 | | 2.9 | 2.9 | 3 | | | | 3.9 | | | | 5 | | 6.7 | | | | |
| Rated Voltage (Vdc) | 25 | 100 | 50 | 25 | 50 | 100 | 100 | 63 | 50 | 25 | 100 | 63 | 50 | 25 | 100 | 25 | 100 | 63 | 50 | 25 | |
| Cap. / TC Code | X5R | X7R | X7R | X6S | X7R | X7R | X7R | X7R | X7R | X7R | X7R | X7R | X7R | X7R | X7R | X7R | X7R | X7R | X7R | X7R | X7R |
| 1.0μF | | p200 | | | | | | | | | | | | | | | | | | | |
| 2.2μF | | | | | p200 | p200 | | | | | | | | | | | | | | | |
| 4.7μF | | | p200 | | | | p200 | p200 | p200 | | | | | | | | | | | | |
| 6.8μF | | | | | | | | | | | p200 | | | | | | | | | | |
| 10μF | p200 | | | p200 | | | | | | | | p200 | p200 | | p200 | | | | | | |
| 15μF | | | | | | | | | | p200 | | | | | | | | p200 | | | |
| 22μF | | | | | | | | | | | | | | p200 | | | | | p200 | p200 | |
| 33μF | | | | | | | | | | | | | | | p200 | | | | | | |
| 47μF | | | | | | | | | | | | | | | | | | | | | p200 |

■ KR3 Series High Dielectric Constant Type

p00 ← Part Number List EIA: X7T

| LxW (mm) | 6.1x5.3 | | | | | | | | | |
|---------------------|---------|------|------|------|------|------|------|------|------|------|
| | 3 | | | 3.9 | | | 5 | 6.7 | | |
| T max. (mm) | 3 | | | 3.9 | | | 5 | 6.7 | | |
| Rated Voltage (Vdc) | 630 | 450 | 250 | 630 | 450 | 250 | 450 | 630 | 450 | 250 |
| Cap. / TC Code | X7T | X7T | X7T | X7T | X7T | X7T | X7T | X7T | X7T | X7T |
| 0.1μF | p204 | | | | | | | | | |
| 0.15μF | p204 | | | | | | | | | |
| 0.22μF | | p204 | | p204 | | | | | | |
| 0.27μF | | | | p204 | | | | | | |
| 0.47μF | | p204 | p204 | | | | | p204 | | |
| 0.56μF | | | | | p204 | | | p204 | | |
| 1.0μF | | | | | | p204 | p204 | | | |
| 1.2μF | | | | | | | | | p204 | |
| 2.2μF | | | | | | | | | | p204 |

● Part Numbering

Chip Monolithic Ceramic Capacitors

(Part Number)

| | | | | | | | | | |
|----|---|----|---|----|----|-----|---|-----|---|
| GR | M | 18 | 8 | B1 | 1H | 102 | K | A01 | D |
| ① | ② | ③ | ④ | ⑤ | ⑥ | ⑦ | ⑧ | ⑨ | ⑩ |

① Product ID

② Series

| Product ID | Code | Series |
|------------|----------|---|
| GR | J | Soft Termination Type |
| | M | Tin Plated Layer |
| | 3 | Large Capacitance and High Allowable Ripple Current |
| | 4 | Only for Information Devices |
| | 7 | Only for Camera Flash Circuit |
| GQ | M | High Frequency for Flow/Reflow Soldering |
| GM | A | Monolithic Microchip |
| | D | For Bonding |
| GN | M | Capacitor Array |
| LL | L | Low ESL Type |
| | R | Controlled ESR Low ESL Type |
| | A | 8-termination Low ESL Type |
| | M | 10-termination Low ESL Type |
| GJ | M | High Frequency Low Loss Type |
| | 4 | Low Distortion Type |
| | 8 | Low Acoustic Type |
| GA | 2 | For AC250V (r.m.s.) |
| | 3 | Safety Standard Certified Type |
| GW | M | For Decoupling |

③ Dimensions (L×W)

| Code | Dimensions (L×W) | EIA |
|-----------|------------------|--------|
| 02 | 0.4×0.2mm | 01005 |
| 03 | 0.6×0.3mm | 0201 |
| 05 | 0.5×0.5mm | 0202 |
| 08 | 0.8×0.8mm | 0303 |
| 0D | 0.38×0.38mm | 015015 |
| 0M | 0.9×0.6mm | 0302 |
| 15 | 1.0×0.5mm | 0402 |
| 18 | 1.6×0.8mm | 0603 |
| 1M | 1.37×1.0mm | 0504 |
| 1U | 0.6×1.0mm | 02404 |
| 21 | 2.0×1.25mm | 0805 |
| 22 | 2.8×2.8mm | 1111 |
| 31 | 3.2×1.6mm | 1206 |
| 32 | 3.2×2.5mm | 1210 |
| 42 | 4.5×2.0mm | 1808 |
| 43 | 4.5×3.2mm | 1812 |
| 52 | 5.7×2.8mm | 2211 |
| 55 | 5.7×5.0mm | 2220 |

④ Dimension (T) (Except GNM)

| Code | Dimension (T) |
|----------|----------------------------------|
| 2 | 0.2mm |
| 3 | 0.3mm |
| 4 | 0.4mm |
| 5 | 0.5mm |
| 6 | 0.6mm |
| 7 | 0.7mm |
| 8 | 0.8mm |
| 9 | 0.85mm |
| A | 1.0mm |
| B | 1.25mm |
| C | 1.6mm |
| D | 2.0mm |
| E | 2.5mm |
| F | 3.2mm |
| M | 1.15mm |
| N | 1.35mm |
| Q | 1.5mm |
| R | 1.8mm |
| S | 2.8mm |
| X | Depends on individual standards. |

④ Elements (GNM Only)

| Code | Elements |
|----------|------------|
| 2 | 2-elements |
| 4 | 4-elements |

Continued on the following page.

Continued from the preceding page.

⑤ Temperature Characteristics

| Temperature Characteristic Codes | | | Temperature Characteristics | | | Operating Temperature Range | Capacitance Change Each Temperature (%) | | | | | |
|----------------------------------|-----------------|-----------------------|-----------------------------|---|---------------------|-----------------------------|---|-------|-------|-------|------|-------|
| Code | Public STD Code | Reference Temperature | Temperature Range | Capacitance Change or Temperature Coefficient | -55°C | | -25°C | | -10°C | | | |
| | | | | | Max. | | Min. | Max. | Min. | Max. | Min. | |
| 0C | CHA | *2 | 20°C | 20 to 150°C | 0±60ppm/°C | -55 to 150°C | 0.82 | -0.45 | 0.49 | -0.27 | 0.33 | -0.18 |
| 1C | CG | JIS | 20°C | 20 to 125°C | 0±30ppm/°C | -55 to 125°C | 0.54 | -0.23 | 0.33 | -0.14 | 0.22 | -0.09 |
| 1X | SL | JIS | 20°C | 20 to 85°C | +350 to -1000ppm/°C | -55 to 125°C | - | - | - | - | - | - |
| 2C | CH | JIS | 20°C | 20 to 125°C | 0±60ppm/°C | -55 to 125°C | 0.82 | -0.45 | 0.49 | -0.27 | 0.33 | -0.18 |
| 2P | PH | JIS | 20°C | 20 to 85°C | -150±60ppm/°C | -25 to 85°C | - | - | 1.32 | 0.41 | 0.88 | 0.27 |
| 2R | RH | JIS | 20°C | 20 to 85°C | -220±60ppm/°C | -25 to 85°C | - | - | 1.7 | 0.72 | 1.13 | 0.48 |
| 2S | SH | JIS | 20°C | 20 to 85°C | -330±60ppm/°C | -25 to 85°C | - | - | 2.3 | 1.22 | 1.54 | 0.81 |
| 2T | TH | JIS | 20°C | 20 to 85°C | -470±60ppm/°C | -25 to 85°C | - | - | 3.07 | 1.85 | 2.05 | 1.23 |
| 3C | CJ | JIS | 20°C | 20 to 125°C | 0±120ppm/°C | -55 to 125°C | 1.37 | -0.9 | 0.82 | -0.54 | 0.55 | -0.36 |
| 3P | PJ | JIS | 20°C | 20 to 85°C | -150±120ppm/°C | -25 to 85°C | - | - | 1.65 | 0.14 | 1.1 | 0.09 |
| 3R | RJ | JIS | 20°C | 20 to 85°C | -220±120ppm/°C | -25 to 85°C | - | - | 2.03 | 0.45 | 1.35 | 0.3 |
| 3S | SJ | JIS | 20°C | 20 to 85°C | -330±120ppm/°C | -25 to 85°C | - | - | 2.63 | 0.95 | 1.76 | 0.63 |
| 3T | TJ | JIS | 20°C | 20 to 85°C | -470±120ppm/°C | -25 to 85°C | - | - | 3.4 | 1.58 | 2.27 | 1.05 |
| 3U | UJ | JIS | 20°C | 20 to 85°C | -750±120ppm/°C | -25 to 85°C | - | - | 4.94 | 2.84 | 3.29 | 1.89 |
| 4C | CK | JIS | 20°C | 20 to 125°C | 0±250ppm/°C | -55 to 125°C | 2.56 | -1.88 | 1.54 | -1.13 | 1.02 | -0.75 |
| 4P | PK | JIS | 20°C | 20 to 85°C | -150±250ppm/°C | -25 to 85°C | - | - | 2.36 | -0.45 | 1.57 | -0.3 |
| 4R | RK | JIS | 20°C | 20 to 85°C | -220±250ppm/°C | -25 to 85°C | - | - | 2.74 | -0.14 | 1.83 | -0.09 |
| 4S | SK | JIS | 20°C | 20 to 85°C | -330±250ppm/°C | -25 to 85°C | - | - | 3.35 | 0.36 | 2.23 | 0.24 |
| 4T | TK | JIS | 20°C | 20 to 85°C | -470±250ppm/°C | -25 to 85°C | - | - | 4.12 | 0.99 | 2.74 | 0.66 |
| 4U | UK | JIS | 20°C | 20 to 85°C | -750±250ppm/°C | -25 to 85°C | - | - | 5.65 | 2.25 | 3.77 | 1.5 |
| 5C | C0G | EIA | 25°C | 25 to 125°C | 0±30ppm/°C | -55 to 125°C | 0.58 | -0.24 | 0.4 | -0.17 | 0.25 | -0.11 |
| 5G | X8G | *2 | 25°C | 25 to 150°C | 0±30ppm/°C | -55 to 150°C | 0.58 | -0.24 | 0.4 | -0.17 | 0.25 | -0.11 |
| 6C | C0H | EIA | 25°C | 25 to 125°C | 0±60ppm/°C | -55 to 125°C | 0.87 | -0.48 | 0.59 | -0.33 | 0.38 | -0.21 |
| 6P | P2H | EIA | 25°C | 25 to 85°C | -150±60ppm/°C | -55 to 125°C | 2.33 | 0.72 | 1.61 | 0.5 | 1.02 | 0.32 |
| 6R | R2H | EIA | 25°C | 25 to 85°C | -220±60ppm/°C | -55 to 125°C | 3.02 | 1.28 | 2.08 | 0.88 | 1.32 | 0.56 |
| 6S | S2H | EIA | 25°C | 25 to 85°C | -330±60ppm/°C | -55 to 125°C | 4.09 | 2.16 | 2.81 | 1.49 | 1.79 | 0.95 |
| 6T | T2H | EIA | 25°C | 25 to 85°C | -470±60ppm/°C | -55 to 125°C | 5.46 | 3.28 | 3.75 | 2.26 | 2.39 | 1.44 |
| 7U | U2J | EIA | 25°C | 25 to 125°C *5 | -750±120ppm/°C | -55 to 125°C | 8.78 | 5.04 | 6.04 | 3.47 | 3.84 | 2.21 |
| B1 | B *1 | JIS | 20°C | -25 to 85°C | ±10% | -25 to 85°C | - | - | - | - | - | - |
| B3 | B | JIS | 20°C | -25 to 85°C | ±10% | -25 to 85°C | - | - | - | - | - | - |
| C3 | C | JIS | 20°C | -25 to 85°C | ±20% | -25 to 125°C | - | - | - | - | - | - |
| | | | | 85 to 125°C | +15%, -30% | | - | - | - | - | - | - |
| C6 | X5S | EIA | 25°C | -55 to 85°C | ±22% | -55 to 85°C | - | - | - | - | - | - |
| C7 | X7S | EIA | 25°C | -55 to 125°C | ±22% | -55 to 125°C | - | - | - | - | - | - |
| C8 | X6S | EIA | 25°C | -55 to 105°C | ±22% | -55 to 105°C | - | - | - | - | - | - |
| D3 | D | JIS | 20°C | -25 to 125°C | +20%, -30% | -25 to 85°C | - | - | - | - | - | - |
| D6 | X5T | EIA | 25°C | -55 to 125°C | +22%, -33% | -55 to 125°C | - | - | - | - | - | - |
| D7 | X7T | EIA | 25°C | -55 to 125°C | +22%, -33% | -55 to 125°C | - | - | - | - | - | - |
| D8 | X6T | EIA | 25°C | -55 to 105°C | +22%, -33% | -55 to 105°C | - | - | - | - | - | - |
| E1 | E (1/2Ur) | JIS | 20°C | -25 to 85°C | +20%, -55% | -25 to 85°C | - | - | - | - | - | - |
| E4 | Z5U | EIA | 25°C | 10 to 85°C | +22%, -56% | 10 to 85°C | - | - | - | - | - | - |
| E7 | X7U | EIA | 25°C | -55 to 125°C | +22%, -56% | -55 to 125°C | - | - | - | - | - | - |
| F1 | F *1 | JIS | 20°C | -25 to 85°C | +30%, -80% | -25 to 85°C | - | - | - | - | - | - |
| F4 | Z5V | EIA | 25°C | 10 to 85°C | +22%, -82% | -20 to 85°C | - | - | - | - | - | - |
| F5 | Y5V | EIA | 25°C | -30 to 85°C | +22%, -82% | -30 to 85°C | - | - | - | - | - | - |
| J1 | JA | *2 | 20°C | -25 to 105°C | -20% max. | -25 to 105°C | - | - | - | - | - | - |
| L8 | X8L | *2 | 25°C | -55 to 150°C | +15%, -40% | -55 to 150°C | - | - | - | - | - | - |

*1 Capacitance change is specified with 50% rated voltage applied.

*2 Murata Temperature Characteristic Code.

*5 Rated Voltage 100Vdc max: 25 to 85°C

Continued on the following page. ↗

Please check the MURATA home page (<http://www.murata.com/>) if you cannot find the part number in the catalog.

Continued from the preceding page.

| Temperature Characteristic Codes | | | Temperature Characteristics | | | Operating Temperature Range | Capacitance Change Each Temperature (%) | | | | | |
|----------------------------------|-----------------|-----------------------|-----------------------------|---|---------------|-----------------------------|---|------|-------|------|------|---|
| Code | Public STD Code | Reference Temperature | Temperature Range | Capacitance Change or Temperature Coefficient | -55°C | | -25°C | | -10°C | | | |
| | | | | | Max. | | Min. | Max. | Min. | Max. | Min. | |
| R1 | R *1 | JIS | 20°C | -55 to 125°C | ±15% | -55 to 125°C | - | - | - | - | - | - |
| R3 | R | JIS | 20°C | -55 to 125°C | ±15% | -55 to 125°C | - | - | - | - | - | - |
| R6 | X5R | EIA | 25°C | -55 to 85°C | ±15% | -55 to 85°C | - | - | - | - | - | - |
| R7 | X7R | EIA | 25°C | -55 to 125°C | ±15% | -55 to 125°C | - | - | - | - | - | - |
| R8 | R *1 | JIS | 20°C | -25 to 85°C | ±15% | -25 to 85°C | - | - | - | - | - | - |
| R9 | X8R | EIA | 25°C | -55 to 150°C | ±15% | -55 to 150°C | - | - | - | - | - | - |
| W0 | - | *2 | 25°C | -55 to 125°C | ±10% *3 | -55 to 125°C | - | - | - | - | - | - |
| | | | | | +22%, -33% *4 | | - | - | - | - | - | - |

*1 Capacitance change is specified with 50% rated voltage applied.

*2 Murata Temperature Characteristic Code.

*3 Apply DC350V bias.

*4 No DC bias.

⑥ Rated Voltage

| Code | Rated Voltage |
|------|---|
| 0E | DC2.5V |
| 0G | DC4V |
| 0J | DC6.3V |
| 1A | DC10V |
| 1C | DC16V |
| 1E | DC25V |
| YA | DC35V |
| 1H | DC50V |
| 2A | DC100V |
| 2D | DC200V |
| 2E | DC250V |
| YD | DC300V |
| 2W | DC450V |
| 2H | DC500V |
| 2J | DC630V |
| 3A | DC1kV |
| 3D | DC2kV |
| 3F | DC3.15kV |
| BB | DC350V (for Camera Flash Circuit) |
| E2 | AC250V |
| GC | X1/Y2; AC250V (Safety Standard Certified Type GC) |
| GF | Y2, X1/Y2; AC250V (Safety Standard Certified Type GF) |
| GD | Y3; AC250V (Safety Standard Certified Type GD) |
| GB | X2; AC250V (Safety Standard Certified Type GB) |

⑦ Capacitance

Expressed by three-digit alphanumerics. The unit is picofarad (pF). The first and second figures are significant digits, and the third figure expresses the number of zeros which follow the two numbers. If there is a decimal point, it is expressed by the capital letter "R." In this case, all figures are significant digits. If any alphabet, other than "R", is included, this indicates the specific part number is a non-standard part.

Ex.)

| Code | Capacitance |
|------|-------------|
| R50 | 0.5pF |
| 1R0 | 1.0pF |
| 100 | 10pF |
| 103 | 10000pF |

⑧ Capacitance Tolerance

| Code | Capacitance Tolerance |
|------|----------------------------------|
| B | ±0.1pF |
| C | ±0.25pF |
| D | ±0.5pF (10pF and below) |
| | ±0.5% (10pF and over) |
| F | ±1% |
| G | ±2% |
| J | ±5% |
| K | ±10% |
| M | ±20% |
| N | ±30% |
| R | Depends on individual standards. |
| W | ±0.05pF |
| X | Depends on individual standards. |
| Y | Depends on individual standards. |
| Z | +80/-20% |

⑨ Individual Specification Code (Except LLR)

Expressed by three figures.

⑩ ESR (LLR Only)

| Code | ESR |
|------|--------|
| E01 | 100mΩ |
| E03 | 220mΩ |
| E05 | 470mΩ |
| E07 | 1000mΩ |

⑪ Packaging

| Code | Packaging |
|------|-----------------------------|
| L | ø180mm Embossed Taping |
| D | ø180mm Paper Taping |
| E | ø180mm Paper Taping (LLL15) |
| K | ø330mm Embossed Taping |
| J | ø330mm Paper Taping |
| F | ø330mm Paper Taping (LLL15) |
| B | Bulk |
| C | Bulk Case |
| T | Bulk Tray |

Please check the MURATA home page (<http://www.murata.com/>) if you cannot find the part number in the catalog.

Metal Terminal Monolithic Ceramic Capacitors

(Part Number)

| | | | | | | | | | |
|----|---|----|---|----|----|-----|---|-----|---|
| KR | M | 55 | T | R7 | 2A | 106 | M | H01 | K |
| ① | ② | ③ | ④ | ⑤ | ⑥ | ⑦ | ⑧ | ⑨ | ⑩ |

① Product ID

② Series

| Product ID | Code | Series |
|------------|------|--|
| KR | M | Metal Terminal Monolithic Ceramic Capacitors (DC25V to DC100V) |
| KR | 3 | Metal Terminal Monolithic Ceramic Capacitors Large Capacitance and High Allowable Ripple Current Type (DC250V to DC630V) |

③ Chip Dimension (L×W)

| Code | Chip Dimension | EIA |
|------|----------------|------|
| 31 | 3.2×1.6mm | 1206 |
| 55 | 5.7×5.0mm | 2220 |

⑤ Temperature Characteristics

| Temperature Characteristic Codes | | | Temperature Characteristics | | | Operating Temperature Range |
|----------------------------------|-----------------|-----|-----------------------------|-------------------|-------------------------|-----------------------------|
| Code | Public STD Code | | Reference Temperature | Temperature Range | Temperature Coefficient | |
| C8 | X6S | EIA | 25°C | -55 to 105°C | ±22% | -55 to 105°C |
| D7 | X7T | EIA | 25°C | -55 to 125°C | +22/-33% | -55 to 125°C |
| R6 | X5R | EIA | 25°C | -55 to 85°C | ±15% | -55 to 85°C |
| R7 | X7R | EIA | 25°C | -55 to 125°C | ±15% | -55 to 125°C |

⑥ Rated Voltage

| Code | Rated Voltage |
|------|---------------|
| 1E | DC25V |
| 1H | DC50V |
| 1J | DC63V |
| 2A | DC100V |
| 2E | DC250V |
| 2W | DC450V |
| 2J | DC630V |

⑦ Capacitance

Expressed by three-digit alphanumerics. The unit is pico-farad (pF). The first and second figures are significant digits, and the third figure expresses the number of zeros that follow the two numbers.

Ex.)

| Code | Capacitance |
|------|-------------|
| 105 | 1.0μF |
| 225 | 2.2μF |
| 106 | 10μF |
| 226 | 22μF |

④ Height Dimension (T)

| Code | Dimension (T) |
|------|---------------|
| F | 1.9mm |
| K | 2.7mm |
| L | 2.8mm |
| Q | 3.7mm |
| T | 4.8mm |
| W | 6.4mm |

⑧ Capacitance Tolerance

| Code | Capacitance Tolerance |
|------|-----------------------|
| K | ±10% |
| M | ±20% |

⑨ Individual Specification Code

Expressed by three figures.

⑩ Package

| Code | Package |
|------|------------------------|
| K | ø330mm Embossed Taping |

Please check the MURATA home page (<http://www.murata.com/>) if you cannot find the part number in the catalog.

Contents

Chip Monolithic Ceramic Capacitors

For General Purpose GRM Series
(Less than 250Vdc) p21

Capacitor Array GNM Series p76

Low ESL LLL/LLR/LLA/LLM Series p79

High-Q Type GJM Series p82

High Frequency GQM Series p104

Monolithic Microchip GMA Series p113

For Bonding GMD Series p115

⚠Caution/Notice p118

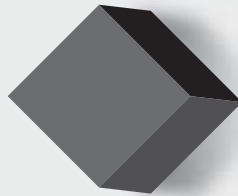
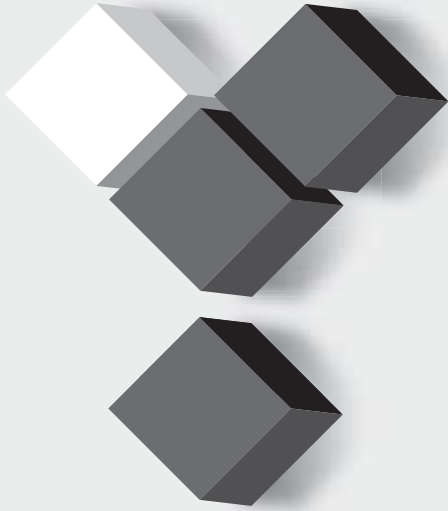

For General Purpose
GRM Series

Capacitor Array
GNM Series

Low ESL
LLL Series

High-Q Type
GJM Series

High Frequency
GQM Series

Monolithic Microchip
GMA Series

For Bonding
GMD Series

Product Information

SEARCH

SPECIFICATIONS AND TEST METHODS, Package, Chart of characteristic data, please refer to the search for capacitor page WEB.

<http://www.murata.com/products/capacitor/>

The screenshot shows the product page for GRM155R60J224ME01#. It includes a product image, a table of dimensions, a table of specifications, a table of references, and a chart of characteristic data. The specifications table is as follows:

| Item | Value |
|--|--------------|
| Rated value | 0.22 μF ±20% |
| Rated voltage | 6.3 Vdc |
| Temperature characteristic (standard) | ±20% |
| Capacitance change rate | ±1% |
| Temperature range of temperature characteristics | -55 to +125 |
| Operating temperature range | -55 to +125 |

The chart of characteristic data includes:

- Frequency characteristics (ESR, Impedance)
- S parameter (Smith chart S11)
- DC bias characteristics
- AC voltage characteristics
- Capacitance - temperature characteristics
- Calorific property by ripple current

Detailed specifications sheet

- Rated value
- SPECIFICATIONS AND TEST METHODS
- Package
- Caution, Notice (Storage, Soldering and Mounting,etc.)

Chart of characteristic data

- The main products published characteristic data.
- Frequency characteristics(ESR, Impedance)
 - S parameter(Smith chart S11)
 - DC bias characteristics
 - AC voltage characteristics
 - Capacitance - temperature characteristics
 - Calorific property by ripple current

Chip Monolithic Ceramic Capacitors

For General Purpose GRM Series (Less than 250Vdc)

The most widely used capacitor in the world!
Ideal capacitors can be selected from an abundant lineup.

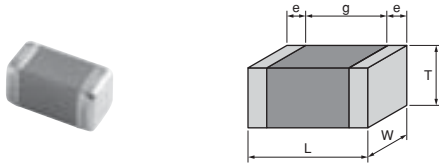

- 1 Lineup of small size and large capacity capacitors is available.
- 2 Since the external electrodes consist of a plated structure, the product is excellent in soldering heat resistance, and flow (GRM18/21/31 types only) and reflow soldering can be used.
- 3 High reliability with no polarity.
- 4 Low impedance in high frequencies, and excellent in pulse response and noise elimination.
- 5 The profile dimensions have been standardized with high precision, therefore high reliability can be acquired in the case of automatic mounting.
- 6 Paper tape or embossed tape is used for the packaging, according to the chip size.
GRM15/18/21 (T = 0.6, 1.25) can also be supplied in bulk cases.

For General Purpose
GRM Series

Capacitor Array
GNM Series

Low ESL
LL□ Series

High-Q Type
GJM Series

High Frequency
GQM Series

Monolithic Microchip
GMA Series

For Bonding
GMD Series

Product Information

GRM Series Temperature Compensating Type Part Number List

■ 0.4x0.2mm Ultra-compact

| T max. | Rated Voltage | TC Code | Cap. | Tol. | Part Number |
|---------|--------------------|--------------------|-------|---------|--------------------|
| 0.22mm | 16Vdc | C0G | 0.2pF | ±0.05pF | GRM0225C1CR20WD05# |
| | | | | ±0.1pF | GRM0225C1CR20BD05# |
| | | | 0.3pF | ±0.05pF | GRM0225C1CR30WD05# |
| | | | | ±0.1pF | GRM0225C1CR30BD05# |
| | | | 0.4pF | ±0.05pF | GRM0225C1CR40WD05# |
| | | | | ±0.1pF | GRM0225C1CR40BD05# |
| | | | 0.5pF | ±0.05pF | GRM0225C1CR50WD05# |
| | | | | ±0.1pF | GRM0225C1CR50BD05# |
| | | | 0.6pF | ±0.05pF | GRM0225C1CR60WD05# |
| | | | | ±0.1pF | GRM0225C1CR60BD05# |
| | | | 0.7pF | ±0.05pF | GRM0225C1CR70WD05# |
| | | | | ±0.1pF | GRM0225C1CR70BD05# |
| | | | 0.8pF | ±0.05pF | GRM0225C1CR80WD05# |
| | | | | ±0.1pF | GRM0225C1CR80BD05# |
| | | | 0.9pF | ±0.05pF | GRM0225C1CR90WD05# |
| | | | | ±0.1pF | GRM0225C1CR90BD05# |
| | | | 1.0pF | ±0.05pF | GRM0225C1C1R0WD05# |
| | | | | ±0.1pF | GRM0225C1C1R0BD05# |
| | | | | ±0.25pF | GRM0225C1C1R0CD05# |
| | | | 1.1pF | ±0.05pF | GRM0225C1C1R1WD05# |
| | | | | ±0.1pF | GRM0225C1C1R1BD05# |
| | | | | ±0.25pF | GRM0225C1C1R1CD05# |
| | | | 1.2pF | ±0.05pF | GRM0225C1C1R2WD05# |
| | | | | ±0.1pF | GRM0225C1C1R2BD05# |
| | | | | ±0.25pF | GRM0225C1C1R2CD05# |
| | | | 1.3pF | ±0.05pF | GRM0225C1C1R3WD05# |
| | | | | ±0.1pF | GRM0225C1C1R3BD05# |
| | | | | ±0.25pF | GRM0225C1C1R3CD05# |
| | | | 1.4pF | ±0.05pF | GRM0225C1C1R4WD05# |
| | | | | ±0.1pF | GRM0225C1C1R4BD05# |
| | | | | ±0.25pF | GRM0225C1C1R4CD05# |
| | | | 1.5pF | ±0.05pF | GRM0225C1C1R5WD05# |
| | | | | ±0.1pF | GRM0225C1C1R5BD05# |
| | | | | ±0.25pF | GRM0225C1C1R5CD05# |
| | | | 1.6pF | ±0.05pF | GRM0225C1C1R6WD05# |
| | | | | ±0.1pF | GRM0225C1C1R6BD05# |
| | | | | ±0.25pF | GRM0225C1C1R6CD05# |
| | | | 1.7pF | ±0.05pF | GRM0225C1C1R7WD05# |
| | | | | ±0.1pF | GRM0225C1C1R7BD05# |
| | | | | ±0.25pF | GRM0225C1C1R7CD05# |
| | | | 1.8pF | ±0.05pF | GRM0225C1C1R8WD05# |
| | | | | ±0.1pF | GRM0225C1C1R8BD05# |
| | | | | ±0.25pF | GRM0225C1C1R8CD05# |
| | | | 1.9pF | ±0.05pF | GRM0225C1C1R9WD05# |
| | | | | ±0.1pF | GRM0225C1C1R9BD05# |
| | | | | ±0.25pF | GRM0225C1C1R9CD05# |
| | | | 2.0pF | ±0.05pF | GRM0225C1C2R0WD05# |
| | | | | ±0.1pF | GRM0225C1C2R0BD05# |
| ±0.25pF | GRM0225C1C2R0CD05# | | | | |
| 2.1pF | ±0.05pF | GRM0225C1C2R1WD05# | | | |
| | ±0.1pF | GRM0225C1C2R1BD05# | | | |
| | ±0.25pF | GRM0225C1C2R1CD05# | | | |

| T max. | Rated Voltage | TC Code | Cap. | Tol. | Part Number |
|--------|---------------|--------------------|-------|---------|--------------------|
| 0.22mm | 16Vdc | C0G | 2.2pF | ±0.05pF | GRM0225C1C2R2WD05# |
| | | | | ±0.1pF | GRM0225C1C2R2BD05# |
| | | | | ±0.25pF | GRM0225C1C2R2CD05# |
| | | | 2.3pF | ±0.05pF | GRM0225C1C2R3WD05# |
| | | | | ±0.1pF | GRM0225C1C2R3BD05# |
| | | | | ±0.25pF | GRM0225C1C2R3CD05# |
| | | | 2.4pF | ±0.05pF | GRM0225C1C2R4WD05# |
| | | | | ±0.1pF | GRM0225C1C2R4BD05# |
| | | | | ±0.25pF | GRM0225C1C2R4CD05# |
| | | | 2.5pF | ±0.05pF | GRM0225C1C2R5WD05# |
| | | | | ±0.1pF | GRM0225C1C2R5BD05# |
| | | | | ±0.25pF | GRM0225C1C2R5CD05# |
| | | | 2.6pF | ±0.05pF | GRM0225C1C2R6WD05# |
| | | | | ±0.1pF | GRM0225C1C2R6BD05# |
| | | | | ±0.25pF | GRM0225C1C2R6CD05# |
| | | | 2.7pF | ±0.05pF | GRM0225C1C2R7WD05# |
| | | | | ±0.1pF | GRM0225C1C2R7BD05# |
| | | | | ±0.25pF | GRM0225C1C2R7CD05# |
| | | | 2.8pF | ±0.05pF | GRM0225C1C2R8WD05# |
| | | | | ±0.1pF | GRM0225C1C2R8BD05# |
| | | | | ±0.25pF | GRM0225C1C2R8CD05# |
| | | | 2.9pF | ±0.05pF | GRM0225C1C2R9WD05# |
| | | | | ±0.1pF | GRM0225C1C2R9BD05# |
| | | | | ±0.25pF | GRM0225C1C2R9CD05# |
| | | | 3.0pF | ±0.05pF | GRM0225C1C3R0WD05# |
| | | | | ±0.1pF | GRM0225C1C3R0BD05# |
| | | | | ±0.25pF | GRM0225C1C3R0CD05# |
| | | | 3.1pF | ±0.05pF | GRM0225C1C3R1WD05# |
| | | | | ±0.1pF | GRM0225C1C3R1BD05# |
| | | | | ±0.25pF | GRM0225C1C3R1CD05# |
| | | | 3.2pF | ±0.05pF | GRM0225C1C3R2WD05# |
| | | | | ±0.1pF | GRM0225C1C3R2BD05# |
| | | | | ±0.25pF | GRM0225C1C3R2CD05# |
| | | | 3.3pF | ±0.05pF | GRM0225C1C3R3WD05# |
| | | | | ±0.1pF | GRM0225C1C3R3BD05# |
| | | | | ±0.25pF | GRM0225C1C3R3CD05# |
| | | | 3.4pF | ±0.05pF | GRM0225C1C3R4WD05# |
| | | | | ±0.1pF | GRM0225C1C3R4BD05# |
| | | | | ±0.25pF | GRM0225C1C3R4CD05# |
| | | | 3.5pF | ±0.05pF | GRM0225C1C3R5WD05# |
| | | | | ±0.1pF | GRM0225C1C3R5BD05# |
| | | | | ±0.25pF | GRM0225C1C3R5CD05# |
| | | | 3.6pF | ±0.05pF | GRM0225C1C3R6WD05# |
| | | | | ±0.1pF | GRM0225C1C3R6BD05# |
| | | | | ±0.25pF | GRM0225C1C3R6CD05# |
| | | | 3.7pF | ±0.05pF | GRM0225C1C3R7WD05# |
| | | | | ±0.1pF | GRM0225C1C3R7BD05# |
| | | | | ±0.25pF | GRM0225C1C3R7CD05# |
| 3.8pF | ±0.05pF | GRM0225C1C3R8WD05# | | | |
| | ±0.1pF | GRM0225C1C3R8BD05# | | | |
| | ±0.25pF | GRM0225C1C3R8CD05# | | | |
| 3.9pF | ±0.05pF | GRM0225C1C3R9WD05# | | | |
| | ±0.1pF | GRM0225C1C3R9BD05# | | | |
| | ±0.25pF | GRM0225C1C3R9CD05# | | | |

Part number # indicates the package specification code.

For General Purpose GRM Series
 Capacitor Array GNM Series
 Low ESL LLI Series
 High-Q Type GJM Series
 High Frequency GQM Series
 Monolithic Microchip GMA Series
 For Bonding GMD Series
 Product Information

GRM Series Temperature Compensating Type Part Number List

(→ ■ 0.4x0.2mm)

| T max. | Rated Voltage | TC Code | Cap. | Tol. | Part Number |
|--------|---------------|---------|-------|---------|--------------------|
| 0.22mm | 16Vdc | C0G | 4.0pF | ±0.05pF | GRM0225C1C4R0WD05# |
| | | | | ±0.1pF | GRM0225C1C4R0BD05# |
| | | | | ±0.25pF | GRM0225C1C4R0CD05# |
| | | | 4.1pF | ±0.05pF | GRM0225C1C4R1WD05# |
| | | | | ±0.1pF | GRM0225C1C4R1BD05# |
| | | | | ±0.25pF | GRM0225C1C4R1CD05# |
| | | | 4.2pF | ±0.05pF | GRM0225C1C4R2WD05# |
| | | | | ±0.1pF | GRM0225C1C4R2BD05# |
| | | | | ±0.25pF | GRM0225C1C4R2CD05# |
| | | | 4.3pF | ±0.05pF | GRM0225C1C4R3WD05# |
| | | | | ±0.1pF | GRM0225C1C4R3BD05# |
| | | | | ±0.25pF | GRM0225C1C4R3CD05# |
| | | | 4.4pF | ±0.05pF | GRM0225C1C4R4WD05# |
| | | | | ±0.1pF | GRM0225C1C4R4BD05# |
| | | | | ±0.25pF | GRM0225C1C4R4CD05# |
| | | | 4.5pF | ±0.05pF | GRM0225C1C4R5WD05# |
| | | | | ±0.1pF | GRM0225C1C4R5BD05# |
| | | | | ±0.25pF | GRM0225C1C4R5CD05# |
| | | | 4.6pF | ±0.05pF | GRM0225C1C4R6WD05# |
| | | | | ±0.1pF | GRM0225C1C4R6BD05# |
| | | | | ±0.25pF | GRM0225C1C4R6CD05# |
| | | | 4.7pF | ±0.05pF | GRM0225C1C4R7WD05# |
| | | | | ±0.1pF | GRM0225C1C4R7BD05# |
| | | | | ±0.25pF | GRM0225C1C4R7CD05# |
| | | | 4.8pF | ±0.05pF | GRM0225C1C4R8WD05# |
| | | | | ±0.1pF | GRM0225C1C4R8BD05# |
| | | | | ±0.25pF | GRM0225C1C4R8CD05# |
| | | | 4.9pF | ±0.05pF | GRM0225C1C4R9WD05# |
| | | | | ±0.1pF | GRM0225C1C4R9BD05# |
| | | | | ±0.25pF | GRM0225C1C4R9CD05# |
| | | | 5.0pF | ±0.05pF | GRM0225C1C5R0WD05# |
| | | | | ±0.1pF | GRM0225C1C5R0BD05# |
| | | | | ±0.25pF | GRM0225C1C5R0CD05# |
| | | | 5.1pF | ±0.05pF | GRM0225C1C5R1WD05# |
| | | | | ±0.1pF | GRM0225C1C5R1BD05# |
| | | | | ±0.25pF | GRM0225C1C5R1CD05# |
| | | | | ±0.5pF | GRM0225C1C5R1DD05# |
| | | | 5.2pF | ±0.05pF | GRM0225C1C5R2WD05# |
| | | | | ±0.1pF | GRM0225C1C5R2BD05# |
| | | | | ±0.25pF | GRM0225C1C5R2CD05# |
| | | | | ±0.5pF | GRM0225C1C5R2DD05# |
| | | | 5.3pF | ±0.05pF | GRM0225C1C5R3WD05# |
| | | | | ±0.1pF | GRM0225C1C5R3BD05# |
| | | | | ±0.25pF | GRM0225C1C5R3CD05# |
| | | | | ±0.5pF | GRM0225C1C5R3DD05# |
| | | | 5.4pF | ±0.05pF | GRM0225C1C5R4WD05# |
| | | | | ±0.1pF | GRM0225C1C5R4BD05# |
| | | | | ±0.25pF | GRM0225C1C5R4CD05# |
| | | | | ±0.5pF | GRM0225C1C5R4DD05# |
| | | | 5.5pF | ±0.05pF | GRM0225C1C5R5WD05# |
| | | | | ±0.1pF | GRM0225C1C5R5BD05# |
| | | | | ±0.25pF | GRM0225C1C5R5CD05# |
| | | | | ±0.5pF | GRM0225C1C5R5DD05# |
| | | | 5.6pF | ±0.05pF | GRM0225C1C5R6WD05# |

| T max. | Rated Voltage | TC Code | Cap. | Tol. | Part Number |
|--------|---------------|---------|-------|---------|--------------------|
| 0.22mm | 16Vdc | C0G | 5.6pF | ±0.1pF | GRM0225C1C5R6BD05# |
| | | | | ±0.25pF | GRM0225C1C5R6CD05# |
| | | | | ±0.5pF | GRM0225C1C5R6DD05# |
| | | | 5.7pF | ±0.05pF | GRM0225C1C5R7WD05# |
| | | | | ±0.1pF | GRM0225C1C5R7BD05# |
| | | | | ±0.25pF | GRM0225C1C5R7CD05# |
| | | | 5.8pF | ±0.05pF | GRM0225C1C5R8WD05# |
| | | | | ±0.1pF | GRM0225C1C5R8BD05# |
| | | | | ±0.25pF | GRM0225C1C5R8CD05# |
| | | | 5.9pF | ±0.05pF | GRM0225C1C5R9WD05# |
| | | | | ±0.1pF | GRM0225C1C5R9BD05# |
| | | | | ±0.25pF | GRM0225C1C5R9CD05# |
| | | | 6.0pF | ±0.05pF | GRM0225C1C6R0WD05# |
| | | | | ±0.1pF | GRM0225C1C6R0BD05# |
| | | | | ±0.25pF | GRM0225C1C6R0CD05# |
| | | | 6.1pF | ±0.05pF | GRM0225C1C6R1WD05# |
| | | | | ±0.1pF | GRM0225C1C6R1BD05# |
| | | | | ±0.25pF | GRM0225C1C6R1CD05# |
| | | | 6.2pF | ±0.05pF | GRM0225C1C6R2WD05# |
| | | | | ±0.1pF | GRM0225C1C6R2BD05# |
| | | | | ±0.25pF | GRM0225C1C6R2CD05# |
| | | | 6.3pF | ±0.05pF | GRM0225C1C6R3WD05# |
| | | | | ±0.1pF | GRM0225C1C6R3BD05# |
| | | | | ±0.25pF | GRM0225C1C6R3CD05# |
| | | | 6.4pF | ±0.05pF | GRM0225C1C6R4WD05# |
| | | | | ±0.1pF | GRM0225C1C6R4BD05# |
| | | | | ±0.25pF | GRM0225C1C6R4CD05# |
| | | | 6.5pF | ±0.05pF | GRM0225C1C6R5WD05# |
| | | | | ±0.1pF | GRM0225C1C6R5BD05# |
| | | | | ±0.25pF | GRM0225C1C6R5CD05# |
| | | | 6.6pF | ±0.05pF | GRM0225C1C6R6WD05# |
| | | | | ±0.1pF | GRM0225C1C6R6BD05# |
| | | | | ±0.25pF | GRM0225C1C6R6CD05# |
| | | | 6.7pF | ±0.05pF | GRM0225C1C6R7WD05# |
| | | | | ±0.1pF | GRM0225C1C6R7BD05# |
| | | | | ±0.25pF | GRM0225C1C6R7CD05# |
| | | | 6.8pF | ±0.05pF | GRM0225C1C6R8WD05# |
| | | | | ±0.1pF | GRM0225C1C6R8BD05# |
| | | | | ±0.25pF | GRM0225C1C6R8CD05# |
| | | | 6.9pF | ±0.05pF | GRM0225C1C6R9WD05# |
| | | | | ±0.1pF | GRM0225C1C6R9BD05# |
| | | | | ±0.25pF | GRM0225C1C6R9CD05# |

Part number # indicates the package specification code.

GRM Series Temperature Compensating Type Part Number List

(→ ■ 0.4x0.2mm)

| T max. | Rated Voltage | TC Code | Cap. | Tol. | Part Number | T max. | Rated Voltage | TC Code | Cap. | Tol. | Part Number |
|--------|---------------|---------|--------|--------------------|--------------------|--------------------|--------------------|--------------------|--------------------|--------------------|--------------------|
| 0.22mm | 16Vdc | C0G | 6.9pF | ±0.5pF | GRM0225C1C6R9DD05# | 0.22mm | 16Vdc | C0G | 8.3pF | ±0.1pF | GRM0225C1C8R3BD05# |
| | | | | ±0.05pF | GRM0225C1C7R0WD05# | | | | | ±0.25pF | GRM0225C1C8R3CD05# |
| | | | | ±0.1pF | GRM0225C1C7R0BD05# | | | | | ±0.5pF | GRM0225C1C8R3DD05# |
| | | | 7.0pF | ±0.25pF | GRM0225C1C7R0CD05# | 8.4pF | ±0.05pF | GRM0225C1C8R4WD05# | | | |
| | | | | ±0.5pF | GRM0225C1C7R0DD05# | | ±0.1pF | GRM0225C1C8R4BD05# | | | |
| | | | | 7.1pF | ±0.05pF | | GRM0225C1C7R1WD05# | ±0.25pF | GRM0225C1C8R4CD05# | | |
| | | | | | ±0.1pF | | GRM0225C1C7R1BD05# | ±0.5pF | GRM0225C1C8R4DD05# | | |
| | | | | | ±0.25pF | | GRM0225C1C7R1CD05# | 8.5pF | ±0.05pF | GRM0225C1C8R5WD05# | |
| | | | ±0.5pF | GRM0225C1C7R1DD05# | ±0.1pF | GRM0225C1C8R5BD05# | | | | | |
| | | | 7.2pF | ±0.05pF | GRM0225C1C7R2WD05# | ±0.25pF | GRM0225C1C8R5CD05# | | | | |
| | | | | ±0.1pF | GRM0225C1C7R2BD05# | ±0.5pF | GRM0225C1C8R5DD05# | | | | |
| | | | | ±0.25pF | GRM0225C1C7R2CD05# | 8.6pF | ±0.05pF | GRM0225C1C8R6WD05# | | | |
| | | | ±0.5pF | GRM0225C1C7R2DD05# | ±0.1pF | | GRM0225C1C8R6BD05# | | | | |
| | | | 7.3pF | ±0.05pF | GRM0225C1C7R3WD05# | | ±0.25pF | GRM0225C1C8R6CD05# | | | |
| | | | | ±0.1pF | GRM0225C1C7R3BD05# | ±0.5pF | GRM0225C1C8R6DD05# | | | | |
| | | | | ±0.25pF | GRM0225C1C7R3CD05# | 8.7pF | ±0.05pF | GRM0225C1C8R7WD05# | | | |
| | | | ±0.5pF | GRM0225C1C7R3DD05# | ±0.1pF | | GRM0225C1C8R7BD05# | | | | |
| | | | 7.4pF | ±0.05pF | GRM0225C1C7R4WD05# | | ±0.25pF | GRM0225C1C8R7CD05# | | | |
| | | | | ±0.1pF | GRM0225C1C7R4BD05# | ±0.5pF | GRM0225C1C8R7DD05# | | | | |
| | | | | ±0.25pF | GRM0225C1C7R4CD05# | 8.8pF | ±0.05pF | GRM0225C1C8R8WD05# | | | |
| | | | ±0.5pF | GRM0225C1C7R4DD05# | ±0.1pF | | GRM0225C1C8R8BD05# | | | | |
| | | | 7.5pF | ±0.05pF | GRM0225C1C7R5WD05# | | ±0.25pF | GRM0225C1C8R8CD05# | | | |
| | | | | ±0.1pF | GRM0225C1C7R5BD05# | ±0.5pF | GRM0225C1C8R8DD05# | | | | |
| | | | | ±0.25pF | GRM0225C1C7R5CD05# | 8.9pF | ±0.05pF | GRM0225C1C8R9WD05# | | | |
| | | | ±0.5pF | GRM0225C1C7R5DD05# | ±0.1pF | | GRM0225C1C8R9BD05# | | | | |
| | | | 7.6pF | ±0.05pF | GRM0225C1C7R6WD05# | | ±0.25pF | GRM0225C1C8R9CD05# | | | |
| | | | | ±0.1pF | GRM0225C1C7R6BD05# | ±0.5pF | GRM0225C1C8R9DD05# | | | | |
| | | | | ±0.25pF | GRM0225C1C7R6CD05# | 9.0pF | ±0.05pF | GRM0225C1C9R0WD05# | | | |
| | | | ±0.5pF | GRM0225C1C7R6DD05# | ±0.1pF | | GRM0225C1C9R0BD05# | | | | |
| | | | 7.7pF | ±0.05pF | GRM0225C1C7R7WD05# | | ±0.25pF | GRM0225C1C9R0CD05# | | | |
| | | | | ±0.1pF | GRM0225C1C7R7BD05# | ±0.5pF | GRM0225C1C9R0DD05# | | | | |
| | | | | ±0.25pF | GRM0225C1C7R7CD05# | 9.1pF | ±0.05pF | GRM0225C1C9R1WD05# | | | |
| | | | ±0.5pF | GRM0225C1C7R7DD05# | ±0.1pF | | GRM0225C1C9R1BD05# | | | | |
| | | | 7.8pF | ±0.05pF | GRM0225C1C7R8WD05# | | ±0.25pF | GRM0225C1C9R1CD05# | | | |
| | | | | ±0.1pF | GRM0225C1C7R8BD05# | ±0.5pF | GRM0225C1C9R1DD05# | | | | |
| | | | | ±0.25pF | GRM0225C1C7R8CD05# | 9.2pF | ±0.05pF | GRM0225C1C9R2WD05# | | | |
| | | | ±0.5pF | GRM0225C1C7R8DD05# | ±0.1pF | | GRM0225C1C9R2BD05# | | | | |
| | | | 7.9pF | ±0.05pF | GRM0225C1C7R9WD05# | | ±0.25pF | GRM0225C1C9R2CD05# | | | |
| | | | | ±0.1pF | GRM0225C1C7R9BD05# | ±0.5pF | GRM0225C1C9R2DD05# | | | | |
| | | | | ±0.25pF | GRM0225C1C7R9CD05# | 9.3pF | ±0.05pF | GRM0225C1C9R3WD05# | | | |
| | | | ±0.5pF | GRM0225C1C7R9DD05# | ±0.1pF | | GRM0225C1C9R3BD05# | | | | |
| | | | 8.0pF | ±0.05pF | GRM0225C1C8R0WD05# | | ±0.25pF | GRM0225C1C9R3CD05# | | | |
| | | | | ±0.1pF | GRM0225C1C8R0BD05# | ±0.5pF | GRM0225C1C9R3DD05# | | | | |
| | | | | ±0.25pF | GRM0225C1C8R0CD05# | 9.4pF | ±0.05pF | GRM0225C1C9R4WD05# | | | |
| | | | ±0.5pF | GRM0225C1C8R0DD05# | ±0.1pF | | GRM0225C1C9R4BD05# | | | | |
| | | | 8.1pF | ±0.05pF | GRM0225C1C8R1WD05# | | ±0.25pF | GRM0225C1C9R4CD05# | | | |
| | | | | ±0.1pF | GRM0225C1C8R1BD05# | ±0.5pF | GRM0225C1C9R4DD05# | | | | |
| | | | | ±0.25pF | GRM0225C1C8R1CD05# | 9.5pF | ±0.05pF | GRM0225C1C9R5WD05# | | | |
| | | | ±0.5pF | GRM0225C1C8R1DD05# | ±0.1pF | | GRM0225C1C9R5BD05# | | | | |
| | | | 8.2pF | ±0.05pF | GRM0225C1C8R2WD05# | | ±0.25pF | GRM0225C1C9R5CD05# | | | |
| | | | | ±0.1pF | GRM0225C1C8R2BD05# | ±0.5pF | GRM0225C1C9R5DD05# | | | | |
| | | | | ±0.25pF | GRM0225C1C8R2CD05# | 9.6pF | ±0.05pF | GRM0225C1C9R6WD05# | | | |
| | | | ±0.5pF | GRM0225C1C8R2DD05# | ±0.1pF | | GRM0225C1C9R6BD05# | | | | |
| | | | 8.3pF | ±0.05pF | GRM0225C1C8R3WD05# | | ±0.25pF | GRM0225C1C9R6CD05# | | | |

Part number # indicates the package specification code.

For General Purpose GRM Series
 Capacitor Array GNM Series
 Low ESL LLC Series
 High-Q Type GJM Series
 High Frequency GQM Series
 Monolithic Microchip GMA Series
 For Bonding GMD Series
 Product Information

GRM Series Temperature Compensating Type Part Number List

(→ ■ 0.4x0.2mm)

| T max. | Rated Voltage | TC Code | Cap. | Tol. | Part Number | T max. | Rated Voltage | TC Code | Cap. | Tol. | Part Number |
|--------|---------------|--------------------|--------------------|--------------------|--------------------|---------|--------------------|--------------------|--------------------|--------------------|--------------------|
| 0.22mm | 16Vdc | C0G | 9.6pF | ±0.5pF | GRM0225C1C9R6DD05# | 0.22mm | 16Vdc | CK | 1.2pF | ±0.1pF | GRM0224C1C1R2BD05# |
| | | | | ±0.05pF | GRM0225C1C9R7WD05# | | | | | ±0.25pF | GRM0224C1C1R2CD05# |
| | | | 9.7pF | ±0.1pF | GRM0225C1C9R7BD05# | 1.3pF | ±0.05pF | | GRM0224C1C1R3WD05# | | |
| | | | | ±0.25pF | GRM0225C1C9R7CD05# | | ±0.1pF | | GRM0224C1C1R3BD05# | | |
| | | | | ±0.5pF | GRM0225C1C9R7DD05# | | ±0.25pF | | GRM0224C1C1R3CD05# | | |
| | | | 9.8pF | ±0.05pF | GRM0225C1C9R8WD05# | 1.4pF | ±0.05pF | | GRM0224C1C1R4WD05# | | |
| | | | | ±0.1pF | GRM0225C1C9R8BD05# | | ±0.1pF | | GRM0224C1C1R4BD05# | | |
| | | | | ±0.25pF | GRM0225C1C9R8CD05# | | ±0.25pF | | GRM0224C1C1R4CD05# | | |
| | | | | ±0.5pF | GRM0225C1C9R8DD05# | | 1.5pF | | ±0.05pF | GRM0224C1C1R5WD05# | |
| | | | 9.9pF | ±0.05pF | GRM0225C1C9R9WD05# | ±0.1pF | | | GRM0224C1C1R5BD05# | | |
| | | | | ±0.1pF | GRM0225C1C9R9BD05# | ±0.25pF | | | GRM0224C1C1R5CD05# | | |
| | | | 10pF | ±0.25pF | GRM0225C1C9R9CD05# | 1.6pF | ±0.05pF | | GRM0224C1C1R6WD05# | | |
| | | | | ±0.5pF | GRM0225C1C9R9DD05# | | ±0.1pF | | GRM0224C1C1R6BD05# | | |
| | | | | ±2% | GRM0225C1C100GD05# | | ±0.25pF | | GRM0224C1C1R6CD05# | | |
| | | | 12pF | ±5% | GRM0225C1C100JD05# | 1.7pF | ±0.05pF | | GRM0224C1C1R7WD05# | | |
| | | | | ±2% | GRM0225C1C120GD05# | | ±0.1pF | | GRM0224C1C1R7BD05# | | |
| | | | ±5% | GRM0225C1C120JD05# | ±0.25pF | | GRM0224C1C1R7CD05# | | | | |
| | | | 15pF | ±2% | GRM0225C1C150GD05# | 1.8pF | ±0.05pF | | GRM0224C1C1R8WD05# | | |
| | | | | ±5% | GRM0225C1C150JD05# | | ±0.1pF | | GRM0224C1C1R8BD05# | | |
| | | | 18pF | ±2% | GRM0225C1C180GD05# | | ±0.25pF | | GRM0224C1C1R8CD05# | | |
| | | | | ±5% | GRM0225C1C180JD05# | 1.9pF | ±0.05pF | | GRM0224C1C1R9WD05# | | |
| | | | 22pF | ±2% | GRM0225C1C220GD05# | | ±0.1pF | | GRM0224C1C1R9BD05# | | |
| | | | | ±5% | GRM0225C1C220JD05# | | ±0.25pF | | GRM0224C1C1R9CD05# | | |
| | | | 27pF | ±2% | GRM0225C1C270GD05# | 2.0pF | ±0.05pF | | GRM0224C1C2R0WD05# | | |
| | | | | ±5% | GRM0225C1C270JD05# | | ±0.1pF | | GRM0224C1C2R0BD05# | | |
| | | 33pF | ±2% | GRM0225C1C330GD05# | ±0.25pF | | GRM0224C1C2R0CD05# | | | | |
| | | | ±5% | GRM0225C1C330JD05# | 2.1pF | ±0.05pF | GRM0223C1C2R1WD05# | | | | |
| | | 39pF | ±2% | GRM0225C1C390GD05# | | ±0.1pF | GRM0223C1C2R1BD05# | | | | |
| | | | ±5% | GRM0225C1C390JD05# | | ±0.25pF | GRM0223C1C2R1CD05# | | | | |
| | | 47pF | ±2% | GRM0225C1C470GD05# | 2.2pF | ±0.05pF | GRM0223C1C2R2WD05# | | | | |
| | | | ±5% | GRM0225C1C470JD05# | | ±0.1pF | GRM0223C1C2R2BD05# | | | | |
| | | 0.2pF | ±0.05pF | GRM0224C1CR20WD05# | | ±0.25pF | GRM0223C1C2R2CD05# | | | | |
| | | | 0.3pF | ±0.05pF | GRM0224C1CR30WD05# | 2.3pF | ±0.05pF | GRM0223C1C2R3WD05# | | | |
| | | | | ±0.1pF | GRM0224C1CR30BD05# | | ±0.1pF | GRM0223C1C2R3BD05# | | | |
| | | ±0.1pF | GRM0224C1CR30BD05# | ±0.25pF | GRM0223C1C2R3CD05# | | | | | | |
| | | 0.4pF | ±0.05pF | GRM0224C1CR40WD05# | 2.4pF | ±0.05pF | GRM0223C1C2R4WD05# | | | | |
| | | | ±0.1pF | GRM0224C1CR40BD05# | | ±0.1pF | GRM0223C1C2R4BD05# | | | | |
| | | 0.5pF | ±0.05pF | GRM0224C1CR50WD05# | | ±0.25pF | GRM0223C1C2R4CD05# | | | | |
| | | | ±0.1pF | GRM0224C1CR50BD05# | 2.5pF | ±0.05pF | GRM0223C1C2R5WD05# | | | | |
| | | 0.6pF | ±0.05pF | GRM0224C1CR60WD05# | | ±0.1pF | GRM0223C1C2R5BD05# | | | | |
| | | | ±0.1pF | GRM0224C1CR60BD05# | | ±0.25pF | GRM0223C1C2R5CD05# | | | | |
| | | 0.7pF | ±0.05pF | GRM0224C1CR70WD05# | 2.6pF | ±0.05pF | GRM0223C1C2R6WD05# | | | | |
| | | | ±0.1pF | GRM0224C1CR70BD05# | | ±0.1pF | GRM0223C1C2R6BD05# | | | | |
| | | 0.8pF | ±0.05pF | GRM0224C1CR80WD05# | | ±0.25pF | GRM0223C1C2R6CD05# | | | | |
| | | | ±0.1pF | GRM0224C1CR80BD05# | 2.7pF | ±0.05pF | GRM0223C1C2R7WD05# | | | | |
| | | 0.9pF | ±0.05pF | GRM0224C1CR90WD05# | | ±0.1pF | GRM0223C1C2R7BD05# | | | | |
| | | | ±0.1pF | GRM0224C1CR90BD05# | | ±0.25pF | GRM0223C1C2R7CD05# | | | | |
| | | 1.0pF | ±0.05pF | GRM0224C1C1R0WD05# | 2.8pF | ±0.05pF | GRM0223C1C2R8WD05# | | | | |
| | | | ±0.1pF | GRM0224C1C1R0BD05# | | ±0.1pF | GRM0223C1C2R8BD05# | | | | |
| | | | ±0.25pF | GRM0224C1C1R0CD05# | | ±0.25pF | GRM0223C1C2R8CD05# | | | | |
| 1.1pF | ±0.05pF | GRM0224C1C1R1WD05# | 2.9pF | ±0.05pF | GRM0223C1C2R9WD05# | | | | | | |
| | ±0.1pF | GRM0224C1C1R1BD05# | | ±0.1pF | GRM0223C1C2R9BD05# | | | | | | |
| | ±0.25pF | GRM0224C1C1R1CD05# | | ±0.25pF | GRM0223C1C2R9CD05# | | | | | | |
| 1.2pF | ±0.05pF | GRM0224C1C1R2WD05# | 3.0pF | ±0.05pF | GRM0223C1C3R0WD05# | | | | | | |
| | | | | | | | | | | | |
| | | CK | | | | | | CJ | | | |

Part number # indicates the package specification code.

GRM Series Temperature Compensating Type Part Number List

(→ ■ 0.4x0.2mm)

| T max. | Rated Voltage | TC Code | Cap. | Tol. | Part Number | | |
|---------|--------------------|--------------------|-------|---------|--------------------|--------------------|--------------------|
| 0.22mm | 16Vdc | CJ | 3.0pF | ±0.1pF | GRM0223C1C3R0BD05# | | |
| | | | | ±0.25pF | GRM0223C1C3R0CD05# | | |
| | | | 3.1pF | ±0.05pF | GRM0223C1C3R1WD05# | | |
| | | | | ±0.1pF | GRM0223C1C3R1BD05# | | |
| | | | | ±0.25pF | GRM0223C1C3R1CD05# | | |
| | | | 3.2pF | ±0.05pF | GRM0223C1C3R2WD05# | | |
| | | | | ±0.1pF | GRM0223C1C3R2BD05# | | |
| | | | | ±0.25pF | GRM0223C1C3R2CD05# | | |
| | | | 3.3pF | ±0.05pF | GRM0223C1C3R3WD05# | | |
| | | | | ±0.1pF | GRM0223C1C3R3BD05# | | |
| | | | | ±0.25pF | GRM0223C1C3R3CD05# | | |
| | | | 3.4pF | ±0.05pF | GRM0223C1C3R4WD05# | | |
| | | | | ±0.1pF | GRM0223C1C3R4BD05# | | |
| | | | | ±0.25pF | GRM0223C1C3R4CD05# | | |
| | | | 3.5pF | ±0.05pF | GRM0223C1C3R5WD05# | | |
| | | | | ±0.1pF | GRM0223C1C3R5BD05# | | |
| | | | | ±0.25pF | GRM0223C1C3R5CD05# | | |
| | | | 3.6pF | ±0.05pF | GRM0223C1C3R6WD05# | | |
| | | | | ±0.1pF | GRM0223C1C3R6BD05# | | |
| | | | | ±0.25pF | GRM0223C1C3R6CD05# | | |
| | | | 3.7pF | ±0.05pF | GRM0223C1C3R7WD05# | | |
| | | | | ±0.1pF | GRM0223C1C3R7BD05# | | |
| | | | | ±0.25pF | GRM0223C1C3R7CD05# | | |
| | | | 3.8pF | ±0.05pF | GRM0223C1C3R8WD05# | | |
| | | | | ±0.1pF | GRM0223C1C3R8BD05# | | |
| | | | | ±0.25pF | GRM0223C1C3R8CD05# | | |
| | | | 3.9pF | ±0.05pF | GRM0223C1C3R9WD05# | | |
| | | | | ±0.1pF | GRM0223C1C3R9BD05# | | |
| | | | | ±0.25pF | GRM0223C1C3R9CD05# | | |
| | | | CH | 16Vdc | 4.0pF | ±0.05pF | GRM0222C1C4R0WD05# |
| | | | | | | ±0.1pF | GRM0222C1C4R0BD05# |
| | | | | | | ±0.25pF | GRM0222C1C4R0CD05# |
| | | | | | 4.1pF | ±0.05pF | GRM0222C1C4R1WD05# |
| | | | | | | ±0.1pF | GRM0222C1C4R1BD05# |
| | | | | | | ±0.25pF | GRM0222C1C4R1CD05# |
| | | | | | 4.2pF | ±0.05pF | GRM0222C1C4R2WD05# |
| | | ±0.1pF | | | | GRM0222C1C4R2BD05# | |
| | | ±0.25pF | | | | GRM0222C1C4R2CD05# | |
| | | 4.3pF | | | ±0.05pF | GRM0222C1C4R3WD05# | |
| | | | | | ±0.1pF | GRM0222C1C4R3BD05# | |
| | | | | | ±0.25pF | GRM0222C1C4R3CD05# | |
| | | 4.4pF | | | ±0.05pF | GRM0222C1C4R4WD05# | |
| | | | | | ±0.1pF | GRM0222C1C4R4BD05# | |
| | | | | | ±0.25pF | GRM0222C1C4R4CD05# | |
| | | 4.5pF | | | ±0.05pF | GRM0222C1C4R5WD05# | |
| | | | | | ±0.1pF | GRM0222C1C4R5BD05# | |
| | | | | | ±0.25pF | GRM0222C1C4R5CD05# | |
| | | 4.6pF | | | ±0.05pF | GRM0222C1C4R6WD05# | |
| ±0.1pF | GRM0222C1C4R6BD05# | | | | | | |
| ±0.25pF | GRM0222C1C4R6CD05# | | | | | | |
| 4.7pF | ±0.05pF | GRM0222C1C4R7WD05# | | | | | |
| | ±0.1pF | GRM0222C1C4R7BD05# | | | | | |
| | ±0.25pF | GRM0222C1C4R7CD05# | | | | | |
| 4.8pF | ±0.05pF | GRM0222C1C4R8WD05# | | | | | |

| T max. | Rated Voltage | TC Code | Cap. | Tol. | Part Number |
|--------|---------------|---------|-------|---------|--------------------|
| 0.22mm | 16Vdc | CH | 4.8pF | ±0.1pF | GRM0222C1C4R8BD05# |
| | | | | ±0.25pF | GRM0222C1C4R8CD05# |
| | | | 4.9pF | ±0.05pF | GRM0222C1C4R9WD05# |
| | | | | ±0.1pF | GRM0222C1C4R9BD05# |
| | | | | ±0.25pF | GRM0222C1C4R9CD05# |
| | | | 5.0pF | ±0.05pF | GRM0222C1C5R0WD05# |
| | | | | ±0.1pF | GRM0222C1C5R0BD05# |
| | | | | ±0.25pF | GRM0222C1C5R0CD05# |
| | | | 5.1pF | ±0.05pF | GRM0222C1C5R1WD05# |
| | | | | ±0.1pF | GRM0222C1C5R1BD05# |
| | | | | ±0.25pF | GRM0222C1C5R1CD05# |
| | | | 5.2pF | ±0.05pF | GRM0222C1C5R2WD05# |
| | | | | ±0.1pF | GRM0222C1C5R2BD05# |
| | | | | ±0.25pF | GRM0222C1C5R2CD05# |
| | | | 5.3pF | ±0.05pF | GRM0222C1C5R3WD05# |
| | | | | ±0.1pF | GRM0222C1C5R3BD05# |
| | | | | ±0.25pF | GRM0222C1C5R3CD05# |
| | | | 5.4pF | ±0.05pF | GRM0222C1C5R4WD05# |
| | | | | ±0.1pF | GRM0222C1C5R4BD05# |
| | | | | ±0.25pF | GRM0222C1C5R4CD05# |
| | | | 5.5pF | ±0.05pF | GRM0222C1C5R5WD05# |
| | | | | ±0.1pF | GRM0222C1C5R5BD05# |
| | | | | ±0.25pF | GRM0222C1C5R5CD05# |
| | | | 5.6pF | ±0.05pF | GRM0222C1C5R6WD05# |
| | | | | ±0.1pF | GRM0222C1C5R6BD05# |
| | | | | ±0.25pF | GRM0222C1C5R6CD05# |
| | | | 5.7pF | ±0.05pF | GRM0222C1C5R7WD05# |
| | | | | ±0.1pF | GRM0222C1C5R7BD05# |
| | | | | ±0.25pF | GRM0222C1C5R7CD05# |
| | | | 5.8pF | ±0.05pF | GRM0222C1C5R8WD05# |
| | | | | ±0.1pF | GRM0222C1C5R8BD05# |
| | | | | ±0.25pF | GRM0222C1C5R8CD05# |
| | | | 5.9pF | ±0.05pF | GRM0222C1C5R9WD05# |
| | | | | ±0.1pF | GRM0222C1C5R9BD05# |
| | | | | ±0.25pF | GRM0222C1C5R9CD05# |
| | | | 6.0pF | ±0.05pF | GRM0222C1C6R0WD05# |
| | | | | ±0.1pF | GRM0222C1C6R0BD05# |
| | | | | ±0.25pF | GRM0222C1C6R0CD05# |
| | | | 6.1pF | ±0.05pF | GRM0222C1C6R1WD05# |
| | | | | ±0.1pF | GRM0222C1C6R1BD05# |
| | | | | ±0.25pF | GRM0222C1C6R1CD05# |
| | | | 6.2pF | ±0.05pF | GRM0222C1C6R2WD05# |
| | | | | ±0.1pF | GRM0222C1C6R2BD05# |

Part number # indicates the package specification code.

For General Purpose GRM Series

Capacitor Array GNM Series

Low ESL LLI Series

High-Q Type GJM Series

High Frequency GQM Series

Monolithic Microchip GMA Series

For Bonding GMD Series

Product Information

GRM Series Temperature Compensating Type Part Number List

(→ ■ 0.4x0.2mm)

| T max. | Rated Voltage | TC Code | Cap. | Tol. | Part Number |
|--------|---------------|---------|-------|---------|--------------------|
| 0.22mm | 16Vdc | CH | 6.2pF | ±0.25pF | GRM0222C1C6R2CD05# |
| | | | | ±0.5pF | GRM0222C1C6R2DD05# |
| | | | 6.3pF | ±0.05pF | GRM0222C1C6R3WD05# |
| | | | | ±0.1pF | GRM0222C1C6R3BD05# |
| | | | | ±0.25pF | GRM0222C1C6R3CD05# |
| | | | | ±0.5pF | GRM0222C1C6R3DD05# |
| | | | 6.4pF | ±0.05pF | GRM0222C1C6R4WD05# |
| | | | | ±0.1pF | GRM0222C1C6R4BD05# |
| | | | | ±0.25pF | GRM0222C1C6R4CD05# |
| | | | | ±0.5pF | GRM0222C1C6R4DD05# |
| | | | 6.5pF | ±0.05pF | GRM0222C1C6R5WD05# |
| | | | | ±0.1pF | GRM0222C1C6R5BD05# |
| | | | | ±0.25pF | GRM0222C1C6R5CD05# |
| | | | | ±0.5pF | GRM0222C1C6R5DD05# |
| | | | 6.6pF | ±0.05pF | GRM0222C1C6R6WD05# |
| | | | | ±0.1pF | GRM0222C1C6R6BD05# |
| | | | | ±0.25pF | GRM0222C1C6R6CD05# |
| | | | | ±0.5pF | GRM0222C1C6R6DD05# |
| | | | 6.7pF | ±0.05pF | GRM0222C1C6R7WD05# |
| | | | | ±0.1pF | GRM0222C1C6R7BD05# |
| | | | | ±0.25pF | GRM0222C1C6R7CD05# |
| | | | | ±0.5pF | GRM0222C1C6R7DD05# |
| | | | 6.8pF | ±0.05pF | GRM0222C1C6R8WD05# |
| | | | | ±0.1pF | GRM0222C1C6R8BD05# |
| | | | | ±0.25pF | GRM0222C1C6R8CD05# |
| | | | | ±0.5pF | GRM0222C1C6R8DD05# |
| | | | 6.9pF | ±0.05pF | GRM0222C1C6R9WD05# |
| | | | | ±0.1pF | GRM0222C1C6R9BD05# |
| | | | | ±0.25pF | GRM0222C1C6R9CD05# |
| | | | | ±0.5pF | GRM0222C1C6R9DD05# |
| | | | 7.0pF | ±0.05pF | GRM0222C1C7R0WD05# |
| | | | | ±0.1pF | GRM0222C1C7R0BD05# |
| | | | | ±0.25pF | GRM0222C1C7R0CD05# |
| | | | | ±0.5pF | GRM0222C1C7R0DD05# |
| | | | 7.1pF | ±0.05pF | GRM0222C1C7R1WD05# |
| | | | | ±0.1pF | GRM0222C1C7R1BD05# |
| | | | | ±0.25pF | GRM0222C1C7R1CD05# |
| | | | | ±0.5pF | GRM0222C1C7R1DD05# |
| | | | 7.2pF | ±0.05pF | GRM0222C1C7R2WD05# |
| | | | | ±0.1pF | GRM0222C1C7R2BD05# |
| | | | | ±0.25pF | GRM0222C1C7R2CD05# |
| | | | | ±0.5pF | GRM0222C1C7R2DD05# |
| | | | 7.3pF | ±0.05pF | GRM0222C1C7R3WD05# |
| | | | | ±0.1pF | GRM0222C1C7R3BD05# |
| | | | | ±0.25pF | GRM0222C1C7R3CD05# |
| | | | | ±0.5pF | GRM0222C1C7R3DD05# |
| | | | 7.4pF | ±0.05pF | GRM0222C1C7R4WD05# |
| | | | | ±0.1pF | GRM0222C1C7R4BD05# |
| | | | | ±0.25pF | GRM0222C1C7R4CD05# |
| | | | | ±0.5pF | GRM0222C1C7R4DD05# |
| | | | 7.5pF | ±0.05pF | GRM0222C1C7R5WD05# |
| | | | | ±0.1pF | GRM0222C1C7R5BD05# |
| | | | | ±0.25pF | GRM0222C1C7R5CD05# |
| | | | | ±0.5pF | GRM0222C1C7R5DD05# |

| T max. | Rated Voltage | TC Code | Cap. | Tol. | Part Number |
|--------|---------------|---------|-------|---------|--------------------|
| 0.22mm | 16Vdc | CH | 7.6pF | ±0.05pF | GRM0222C1C7R6WD05# |
| | | | | ±0.1pF | GRM0222C1C7R6BD05# |
| | | | | ±0.25pF | GRM0222C1C7R6CD05# |
| | | | | ±0.5pF | GRM0222C1C7R6DD05# |
| | | | 7.7pF | ±0.05pF | GRM0222C1C7R7WD05# |
| | | | | ±0.1pF | GRM0222C1C7R7BD05# |
| | | | | ±0.25pF | GRM0222C1C7R7CD05# |
| | | | 7.8pF | ±0.05pF | GRM0222C1C7R8WD05# |
| | | | | ±0.1pF | GRM0222C1C7R8BD05# |
| | | | | ±0.25pF | GRM0222C1C7R8CD05# |
| | | | 7.9pF | ±0.05pF | GRM0222C1C7R9WD05# |
| | | | | ±0.1pF | GRM0222C1C7R9BD05# |
| | | | | ±0.25pF | GRM0222C1C7R9CD05# |
| | | | 8.0pF | ±0.05pF | GRM0222C1C8R0WD05# |
| | | | | ±0.1pF | GRM0222C1C8R0BD05# |
| | | | | ±0.25pF | GRM0222C1C8R0CD05# |
| | | | 8.1pF | ±0.05pF | GRM0222C1C8R1WD05# |
| | | | | ±0.1pF | GRM0222C1C8R1BD05# |
| | | | | ±0.25pF | GRM0222C1C8R1CD05# |
| | | | 8.2pF | ±0.05pF | GRM0222C1C8R2WD05# |
| | | | | ±0.1pF | GRM0222C1C8R2BD05# |
| | | | | ±0.25pF | GRM0222C1C8R2CD05# |
| | | | 8.3pF | ±0.05pF | GRM0222C1C8R3WD05# |
| | | | | ±0.1pF | GRM0222C1C8R3BD05# |
| | | | | ±0.25pF | GRM0222C1C8R3CD05# |
| | | | 8.4pF | ±0.05pF | GRM0222C1C8R4WD05# |
| | | | | ±0.1pF | GRM0222C1C8R4BD05# |
| | | | | ±0.25pF | GRM0222C1C8R4CD05# |
| | | | 8.5pF | ±0.05pF | GRM0222C1C8R5WD05# |
| | | | | ±0.1pF | GRM0222C1C8R5BD05# |
| | | | | ±0.25pF | GRM0222C1C8R5CD05# |
| | | | 8.6pF | ±0.05pF | GRM0222C1C8R6WD05# |
| | | | | ±0.1pF | GRM0222C1C8R6BD05# |
| | | | | ±0.25pF | GRM0222C1C8R6CD05# |
| | | | 8.7pF | ±0.05pF | GRM0222C1C8R7WD05# |
| | | | | ±0.1pF | GRM0222C1C8R7BD05# |
| | | | | ±0.25pF | GRM0222C1C8R7CD05# |
| | | | 8.8pF | ±0.05pF | GRM0222C1C8R8WD05# |
| | | | | ±0.1pF | GRM0222C1C8R8BD05# |
| | | | | ±0.25pF | GRM0222C1C8R8CD05# |
| | | | 8.9pF | ±0.05pF | GRM0222C1C8R9WD05# |
| | | | | ±0.1pF | GRM0222C1C8R9BD05# |
| | | | | ±0.25pF | GRM0222C1C8R9CD05# |

Part number # indicates the package specification code.

GRM Series Temperature Compensating Type Part Number List

(→ ■ 0.4x0.2mm)

| T max. | Rated Voltage | TC Code | Cap. | Tol. | Part Number |
|--------|---------------|---------|-------|---------|--------------------|
| 0.22mm | 16Vdc | CH | 8.9pF | ±0.25pF | GRM0222C1C8R9CD05# |
| | | | | ±0.5pF | GRM0222C1C8R9DD05# |
| | | | 9.0pF | ±0.05pF | GRM0222C1C9R0WD05# |
| | | | | ±0.1pF | GRM0222C1C9R0BD05# |
| | | | | ±0.25pF | GRM0222C1C9R0CD05# |
| | | | | ±0.5pF | GRM0222C1C9R0DD05# |
| | | | 9.1pF | ±0.05pF | GRM0222C1C9R1WD05# |
| | | | | ±0.1pF | GRM0222C1C9R1BD05# |
| | | | | ±0.25pF | GRM0222C1C9R1CD05# |
| | | | | ±0.5pF | GRM0222C1C9R1DD05# |
| | | | 9.2pF | ±0.05pF | GRM0222C1C9R2WD05# |
| | | | | ±0.1pF | GRM0222C1C9R2BD05# |
| | | | | ±0.25pF | GRM0222C1C9R2CD05# |
| | | | | ±0.5pF | GRM0222C1C9R2DD05# |
| | | | 9.3pF | ±0.05pF | GRM0222C1C9R3WD05# |
| | | | | ±0.1pF | GRM0222C1C9R3BD05# |
| | | | | ±0.25pF | GRM0222C1C9R3CD05# |
| | | | | ±0.5pF | GRM0222C1C9R3DD05# |
| | | | 9.4pF | ±0.05pF | GRM0222C1C9R4WD05# |
| | | | | ±0.1pF | GRM0222C1C9R4BD05# |
| | | | | ±0.25pF | GRM0222C1C9R4CD05# |
| | | | | ±0.5pF | GRM0222C1C9R4DD05# |
| | | | 9.5pF | ±0.05pF | GRM0222C1C9R5WD05# |
| | | | | ±0.1pF | GRM0222C1C9R5BD05# |
| | | | | ±0.25pF | GRM0222C1C9R5CD05# |
| | | | | ±0.5pF | GRM0222C1C9R5DD05# |
| | | | 9.6pF | ±0.05pF | GRM0222C1C9R6WD05# |
| | | | | ±0.1pF | GRM0222C1C9R6BD05# |
| | | | | ±0.25pF | GRM0222C1C9R6CD05# |
| | | | | ±0.5pF | GRM0222C1C9R6DD05# |
| | | | 9.7pF | ±0.05pF | GRM0222C1C9R7WD05# |
| | | | | ±0.1pF | GRM0222C1C9R7BD05# |
| | | | | ±0.25pF | GRM0222C1C9R7CD05# |
| | | | | ±0.5pF | GRM0222C1C9R7DD05# |
| | | | 9.8pF | ±0.05pF | GRM0222C1C9R8WD05# |
| | | | | ±0.1pF | GRM0222C1C9R8BD05# |
| | | | | ±0.25pF | GRM0222C1C9R8CD05# |
| | | | | ±0.5pF | GRM0222C1C9R8DD05# |
| | | | 9.9pF | ±0.05pF | GRM0222C1C9R9WD05# |
| | | | | ±0.1pF | GRM0222C1C9R9BD05# |
| | | | | ±0.25pF | GRM0222C1C9R9CD05# |
| | | | | ±0.5pF | GRM0222C1C9R9DD05# |
| | | | 10pF | ±2% | GRM0222C1C100GD05# |
| | | | | ±5% | GRM0222C1C100JD05# |
| | | | 12pF | ±2% | GRM0222C1C120GD05# |
| | | | | ±5% | GRM0222C1C120JD05# |
| | | | 15pF | ±2% | GRM0222C1C150GD05# |
| | | | | ±5% | GRM0222C1C150JD05# |
| | | | 18pF | ±2% | GRM0222C1C180GD05# |
| | | | | ±5% | GRM0222C1C180JD05# |
| | | | 22pF | ±2% | GRM0222C1C220GD05# |
| | | | | ±5% | GRM0222C1C220JD05# |
| | | | 27pF | ±2% | GRM0222C1C270GD05# |
| | | | | ±5% | GRM0222C1C270JD05# |

| T max. | Rated Voltage | TC Code | Cap. | Tol. | Part Number | | |
|--------|---------------|--------------------|--------------------|--------------------|--------------------|--------------------|--------------------|
| 0.22mm | 16Vdc | CH | 33pF | ±2% | GRM0222C1C330GD05# | | |
| | | | | ±5% | GRM0222C1C330JD05# | | |
| | | | 39pF | ±2% | GRM0222C1C390GD05# | | |
| | | | | ±5% | GRM0222C1C390JD05# | | |
| | | | 47pF | ±2% | GRM0222C1C470GD05# | | |
| | | | | ±5% | GRM0222C1C470JD05# | | |
| | | | 10Vdc | C0G | 56pF | ±2% | GRM0225C1A560GD05# |
| | | | | | | ±5% | GRM0225C1A560JD05# |
| | | | | | 68pF | ±2% | GRM0225C1A680GD05# |
| | ±5% | GRM0225C1A680JD05# | | | | | |
| | 82pF | ±2% | | | GRM0225C1A820GD05# | | |
| | | ±5% | | | GRM0225C1A820JD05# | | |
| | 100pF | ±2% | | | GRM0225C1A101GD05# | | |
| | | ±5% | | | GRM0225C1A101JD05# | | |
| | CH | 56pF | | | ±2% | GRM0222C1A560GD05# | |
| | | | ±5% | GRM0222C1A560JD05# | | | |
| | | 68pF | ±2% | GRM0222C1A680GD05# | | | |
| | | | ±5% | GRM0222C1A680JD05# | | | |
| 82pF | | ±2% | GRM0222C1A820GD05# | | | | |
| | | ±5% | GRM0222C1A820JD05# | | | | |
| 100pF | | ±2% | GRM0222C1A101GD05# | | | | |
| | | ±5% | GRM0222C1A101JD05# | | | | |

■ 0.6x0.3mm Ultra-compact

| T max. | Rated Voltage | TC Code | Cap. | Tol. | Part Number |
|--------|---------------|--------------------|-------|---------|--------------------|
| 0.33mm | 50Vdc | C0G | 0.1pF | ±0.05pF | GRM0335C1HR10WA01# |
| | | | | ±0.1pF | GRM0335C1HR10BA01# |
| | | | 0.2pF | ±0.05pF | GRM0335C1HR20WA01# |
| | | | | ±0.1pF | GRM0335C1HR20BA01# |
| | | | 0.3pF | ±0.05pF | GRM0335C1HR30WA01# |
| | | | | ±0.1pF | GRM0335C1HR30BA01# |
| | | | 0.4pF | ±0.05pF | GRM0335C1HR40WA01# |
| | | | | ±0.1pF | GRM0335C1HR40BA01# |
| | | | 0.5pF | ±0.05pF | GRM0335C1HR50WA01# |
| | | | | ±0.1pF | GRM0335C1HR50BA01# |
| | | | 0.6pF | ±0.05pF | GRM0335C1HR60WA01# |
| | | | | ±0.1pF | GRM0335C1HR60BA01# |
| | | | 0.7pF | ±0.05pF | GRM0335C1HR70WA01# |
| | | | | ±0.1pF | GRM0335C1HR70BA01# |
| | | | 0.8pF | ±0.05pF | GRM0335C1HR80WA01# |
| | | | | ±0.1pF | GRM0335C1HR80BA01# |
| | | | 0.9pF | ±0.05pF | GRM0335C1HR90WA01# |
| | | | | ±0.1pF | GRM0335C1HR90BA01# |
| | | | 1.0pF | ±0.05pF | GRM0335C1H1R0WA01# |
| | | | | ±0.1pF | GRM0335C1H1R0BA01# |
| | | | | ±0.25pF | GRM0335C1H1R0CA01# |
| | | | 1.1pF | ±0.05pF | GRM0335C1H1R1WA01# |
| | | | | ±0.1pF | GRM0335C1H1R1BA01# |
| | | | | ±0.25pF | GRM0335C1H1R1CA01# |
| 1.2pF | ±0.05pF | GRM0335C1H1R2WA01# | | | |
| | ±0.1pF | GRM0335C1H1R2BA01# | | | |
| | ±0.25pF | GRM0335C1H1R2CA01# | | | |

Part number # indicates the package specification code.

For General Purpose GRM Series
 Capacitor Array GNM Series
 Low ESL LLI Series
 High-Q Type GJM Series
 High Frequency GQM Series
 Monolithic Microchip GMA Series
 For Bonding GMD Series
 Product Information

GRM Series Temperature Compensating Type Part Number List

(→ ■ 0.6x0.3mm)

| T max. | Rated Voltage | TC Code | Cap. | Tol. | Part Number |
|--------|---------------|--------------------|-------|---------|--------------------|
| 0.33mm | 50Vdc | C0G | 1.3pF | ±0.05pF | GRM0335C1H1R3WA01# |
| | | | | ±0.1pF | GRM0335C1H1R3BA01# |
| | | | | ±0.25pF | GRM0335C1H1R3CA01# |
| | | | 1.4pF | ±0.05pF | GRM0335C1H1R4WA01# |
| | | | | ±0.1pF | GRM0335C1H1R4BA01# |
| | | | | ±0.25pF | GRM0335C1H1R4CA01# |
| | | | 1.5pF | ±0.05pF | GRM0335C1H1R5WA01# |
| | | | | ±0.1pF | GRM0335C1H1R5BA01# |
| | | | | ±0.25pF | GRM0335C1H1R5CA01# |
| | | | 1.6pF | ±0.05pF | GRM0335C1H1R6WA01# |
| | | | | ±0.1pF | GRM0335C1H1R6BA01# |
| | | | | ±0.25pF | GRM0335C1H1R6CA01# |
| | | | 1.7pF | ±0.05pF | GRM0335C1H1R7WA01# |
| | | | | ±0.1pF | GRM0335C1H1R7BA01# |
| | | | | ±0.25pF | GRM0335C1H1R7CA01# |
| | | | 1.8pF | ±0.05pF | GRM0335C1H1R8WA01# |
| | | | | ±0.1pF | GRM0335C1H1R8BA01# |
| | | | | ±0.25pF | GRM0335C1H1R8CA01# |
| | | | 1.9pF | ±0.05pF | GRM0335C1H1R9WA01# |
| | | | | ±0.1pF | GRM0335C1H1R9BA01# |
| | | | | ±0.25pF | GRM0335C1H1R9CA01# |
| | | | 2.0pF | ±0.05pF | GRM0335C1H2R0WA01# |
| | | | | ±0.1pF | GRM0335C1H2R0BA01# |
| | | | | ±0.25pF | GRM0335C1H2R0CA01# |
| | | | 2.1pF | ±0.05pF | GRM0335C1H2R1WA01# |
| | | | | ±0.1pF | GRM0335C1H2R1BA01# |
| | | | | ±0.25pF | GRM0335C1H2R1CA01# |
| | | | 2.2pF | ±0.05pF | GRM0335C1H2R2WA01# |
| | | | | ±0.1pF | GRM0335C1H2R2BA01# |
| | | | | ±0.25pF | GRM0335C1H2R2CA01# |
| | | | 2.3pF | ±0.05pF | GRM0335C1H2R3WA01# |
| | | | | ±0.1pF | GRM0335C1H2R3BA01# |
| | | | | ±0.25pF | GRM0335C1H2R3CA01# |
| | | | 2.4pF | ±0.05pF | GRM0335C1H2R4WA01# |
| | | | | ±0.1pF | GRM0335C1H2R4BA01# |
| | | | | ±0.25pF | GRM0335C1H2R4CA01# |
| | | | 2.5pF | ±0.05pF | GRM0335C1H2R5WA01# |
| | | | | ±0.1pF | GRM0335C1H2R5BA01# |
| | | | | ±0.25pF | GRM0335C1H2R5CA01# |
| | | | 2.6pF | ±0.05pF | GRM0335C1H2R6WA01# |
| | | | | ±0.1pF | GRM0335C1H2R6BA01# |
| | | | | ±0.25pF | GRM0335C1H2R6CA01# |
| | | | 2.7pF | ±0.05pF | GRM0335C1H2R7WA01# |
| | | | | ±0.1pF | GRM0335C1H2R7BA01# |
| | | | | ±0.25pF | GRM0335C1H2R7CA01# |
| 2.8pF | ±0.05pF | GRM0335C1H2R8WA01# | | | |
| | ±0.1pF | GRM0335C1H2R8BA01# | | | |
| | ±0.25pF | GRM0335C1H2R8CA01# | | | |
| 2.9pF | ±0.05pF | GRM0335C1H2R9WA01# | | | |
| | ±0.1pF | GRM0335C1H2R9BA01# | | | |
| | ±0.25pF | GRM0335C1H2R9CA01# | | | |
| 3.0pF | ±0.05pF | GRM0335C1H3R0WA01# | | | |
| | ±0.1pF | GRM0335C1H3R0BA01# | | | |
| | ±0.25pF | GRM0335C1H3R0CA01# | | | |

| T max. | Rated Voltage | TC Code | Cap. | Tol. | Part Number |
|--------|---------------|--------------------|-------|---------|--------------------|
| 0.33mm | 50Vdc | C0G | 3.1pF | ±0.05pF | GRM0335C1H3R1WA01# |
| | | | | ±0.1pF | GRM0335C1H3R1BA01# |
| | | | | ±0.25pF | GRM0335C1H3R1CA01# |
| | | | 3.2pF | ±0.05pF | GRM0335C1H3R2WA01# |
| | | | | ±0.1pF | GRM0335C1H3R2BA01# |
| | | | | ±0.25pF | GRM0335C1H3R2CA01# |
| | | | 3.3pF | ±0.05pF | GRM0335C1H3R3WA01# |
| | | | | ±0.1pF | GRM0335C1H3R3BA01# |
| | | | | ±0.25pF | GRM0335C1H3R3CA01# |
| | | | 3.4pF | ±0.05pF | GRM0335C1H3R4WA01# |
| | | | | ±0.1pF | GRM0335C1H3R4BA01# |
| | | | | ±0.25pF | GRM0335C1H3R4CA01# |
| | | | 3.5pF | ±0.05pF | GRM0335C1H3R5WA01# |
| | | | | ±0.1pF | GRM0335C1H3R5BA01# |
| | | | | ±0.25pF | GRM0335C1H3R5CA01# |
| | | | 3.6pF | ±0.05pF | GRM0335C1H3R6WA01# |
| | | | | ±0.1pF | GRM0335C1H3R6BA01# |
| | | | | ±0.25pF | GRM0335C1H3R6CA01# |
| | | | 3.7pF | ±0.05pF | GRM0335C1H3R7WA01# |
| | | | | ±0.1pF | GRM0335C1H3R7BA01# |
| | | | | ±0.25pF | GRM0335C1H3R7CA01# |
| | | | 3.8pF | ±0.05pF | GRM0335C1H3R8WA01# |
| | | | | ±0.1pF | GRM0335C1H3R8BA01# |
| | | | | ±0.25pF | GRM0335C1H3R8CA01# |
| | | | 3.9pF | ±0.05pF | GRM0335C1H3R9WA01# |
| | | | | ±0.1pF | GRM0335C1H3R9BA01# |
| | | | | ±0.25pF | GRM0335C1H3R9CA01# |
| | | | 4.0pF | ±0.05pF | GRM0335C1H4R0WA01# |
| | | | | ±0.1pF | GRM0335C1H4R0BA01# |
| | | | | ±0.25pF | GRM0335C1H4R0CA01# |
| | | | 4.1pF | ±0.05pF | GRM0335C1H4R1WA01# |
| | | | | ±0.1pF | GRM0335C1H4R1BA01# |
| | | | | ±0.25pF | GRM0335C1H4R1CA01# |
| | | | 4.2pF | ±0.05pF | GRM0335C1H4R2WA01# |
| | | | | ±0.1pF | GRM0335C1H4R2BA01# |
| | | | | ±0.25pF | GRM0335C1H4R2CA01# |
| | | | 4.3pF | ±0.05pF | GRM0335C1H4R3WA01# |
| | | | | ±0.1pF | GRM0335C1H4R3BA01# |
| | | | | ±0.25pF | GRM0335C1H4R3CA01# |
| | | | 4.4pF | ±0.05pF | GRM0335C1H4R4WA01# |
| | | | | ±0.1pF | GRM0335C1H4R4BA01# |
| | | | | ±0.25pF | GRM0335C1H4R4CA01# |
| | | | 4.5pF | ±0.05pF | GRM0335C1H4R5WA01# |
| | | | | ±0.1pF | GRM0335C1H4R5BA01# |
| | | | | ±0.25pF | GRM0335C1H4R5CA01# |
| 4.6pF | ±0.05pF | GRM0335C1H4R6WA01# | | | |
| | ±0.1pF | GRM0335C1H4R6BA01# | | | |
| | ±0.25pF | GRM0335C1H4R6CA01# | | | |
| 4.7pF | ±0.05pF | GRM0335C1H4R7WA01# | | | |
| | ±0.1pF | GRM0335C1H4R7BA01# | | | |
| | ±0.25pF | GRM0335C1H4R7CA01# | | | |
| 4.8pF | ±0.05pF | GRM0335C1H4R8WA01# | | | |
| | ±0.1pF | GRM0335C1H4R8BA01# | | | |
| | ±0.25pF | GRM0335C1H4R8CA01# | | | |

Part number # indicates the package specification code.

GRM Series Temperature Compensating Type Part Number List

(→ ■ 0.6x0.3mm)

| T max. | Rated Voltage | TC Code | Cap. | Tol. | Part Number |
|--------|---------------|--------------------|-------|---------|--------------------|
| 0.33mm | 50Vdc | C0G | 4.9pF | ±0.05pF | GRM0335C1H4R9WA01# |
| | | | | ±0.1pF | GRM0335C1H4R9BA01# |
| | | | | ±0.25pF | GRM0335C1H4R9CA01# |
| | | | 5.0pF | ±0.05pF | GRM0335C1H5R0WA01# |
| | | | | ±0.1pF | GRM0335C1H5R0BA01# |
| | | | | ±0.25pF | GRM0335C1H5R0CA01# |
| | | | 5.1pF | ±0.05pF | GRM0335C1H5R1WA01# |
| | | | | ±0.1pF | GRM0335C1H5R1BA01# |
| | | | | ±0.25pF | GRM0335C1H5R1CA01# |
| | | | 5.2pF | ±0.05pF | GRM0335C1H5R2WA01# |
| | | | | ±0.1pF | GRM0335C1H5R2BA01# |
| | | | | ±0.25pF | GRM0335C1H5R2CA01# |
| | | | 5.3pF | ±0.05pF | GRM0335C1H5R3WA01# |
| | | | | ±0.1pF | GRM0335C1H5R3BA01# |
| | | | | ±0.25pF | GRM0335C1H5R3CA01# |
| | | | 5.4pF | ±0.05pF | GRM0335C1H5R4WA01# |
| | | | | ±0.1pF | GRM0335C1H5R4BA01# |
| | | | | ±0.25pF | GRM0335C1H5R4CA01# |
| | | | 5.5pF | ±0.05pF | GRM0335C1H5R5WA01# |
| | | | | ±0.1pF | GRM0335C1H5R5BA01# |
| | | | | ±0.25pF | GRM0335C1H5R5CA01# |
| | | | 5.6pF | ±0.05pF | GRM0335C1H5R6WA01# |
| | | | | ±0.1pF | GRM0335C1H5R6BA01# |
| | | | | ±0.25pF | GRM0335C1H5R6CA01# |
| | | | 5.7pF | ±0.05pF | GRM0335C1H5R7WA01# |
| | | | | ±0.1pF | GRM0335C1H5R7BA01# |
| | | | | ±0.25pF | GRM0335C1H5R7CA01# |
| | | | 5.8pF | ±0.05pF | GRM0335C1H5R8WA01# |
| | | | | ±0.1pF | GRM0335C1H5R8BA01# |
| | | | | ±0.25pF | GRM0335C1H5R8CA01# |
| | | | 5.9pF | ±0.05pF | GRM0335C1H5R9WA01# |
| | | | | ±0.1pF | GRM0335C1H5R9BA01# |
| | | | | ±0.25pF | GRM0335C1H5R9CA01# |
| | | | 6.0pF | ±0.05pF | GRM0335C1H6R0WA01# |
| | | | | ±0.1pF | GRM0335C1H6R0BA01# |
| | | | | ±0.25pF | GRM0335C1H6R0CA01# |
| | | | 6.1pF | ±0.05pF | GRM0335C1H6R1WA01# |
| | | | | ±0.1pF | GRM0335C1H6R1BA01# |
| | | | | ±0.25pF | GRM0335C1H6R1CA01# |
| | | | 6.2pF | ±0.05pF | GRM0335C1H6R2WA01# |
| | | | | ±0.1pF | GRM0335C1H6R2BA01# |
| | | | | ±0.25pF | GRM0335C1H6R2CA01# |
| | | | 6.3pF | ±0.05pF | GRM0335C1H6R3WA01# |
| | | | | ±0.1pF | GRM0335C1H6R3BA01# |
| | | | | ±0.25pF | GRM0335C1H6R3CA01# |
| | | | 6.4pF | ±0.05pF | GRM0335C1H6R4WA01# |
| | | | | ±0.1pF | GRM0335C1H6R4BA01# |
| | | | | ±0.25pF | GRM0335C1H6R4CA01# |
| | | | 6.5pF | ±0.05pF | GRM0335C1H6R5WA01# |
| | | | | ±0.1pF | GRM0335C1H6R5BA01# |
| | | | | ±0.25pF | GRM0335C1H6R5CA01# |
| | | | 6.6pF | ±0.05pF | GRM0335C1H6R6WA01# |
| | | | | ±0.1pF | GRM0335C1H6R6BA01# |
| | | | | ±0.25pF | GRM0335C1H6R6CA01# |
| | | | 6.7pF | ±0.05pF | GRM0335C1H6R7WA01# |
| | | | | ±0.1pF | GRM0335C1H6R7BA01# |
| | | | | ±0.25pF | GRM0335C1H6R7CA01# |
| | | | 6.8pF | ±0.05pF | GRM0335C1H6R8WA01# |
| | | | | ±0.1pF | GRM0335C1H6R8BA01# |
| | | | | ±0.25pF | GRM0335C1H6R8CA01# |
| 6.9pF | ±0.05pF | GRM0335C1H6R9WA01# | | | |
| | ±0.1pF | GRM0335C1H6R9BA01# | | | |
| | ±0.25pF | GRM0335C1H6R9CA01# | | | |
| 7.0pF | ±0.05pF | GRM0335C1H7R0WA01# | | | |
| | ±0.1pF | GRM0335C1H7R0BA01# | | | |
| | ±0.25pF | GRM0335C1H7R0CA01# | | | |
| 7.1pF | ±0.05pF | GRM0335C1H7R1WA01# | | | |
| | ±0.1pF | GRM0335C1H7R1BA01# | | | |
| | ±0.25pF | GRM0335C1H7R1CA01# | | | |
| 7.2pF | ±0.05pF | GRM0335C1H7R2WA01# | | | |
| | ±0.1pF | GRM0335C1H7R2BA01# | | | |
| | ±0.25pF | GRM0335C1H7R2CA01# | | | |
| 7.3pF | ±0.05pF | GRM0335C1H7R3WA01# | | | |
| | ±0.1pF | GRM0335C1H7R3BA01# | | | |
| | ±0.25pF | GRM0335C1H7R3CA01# | | | |
| 7.4pF | ±0.05pF | GRM0335C1H7R4WA01# | | | |
| | ±0.1pF | GRM0335C1H7R4BA01# | | | |
| | ±0.25pF | GRM0335C1H7R4CA01# | | | |
| 7.5pF | ±0.05pF | GRM0335C1H7R5WA01# | | | |
| | ±0.1pF | GRM0335C1H7R5BA01# | | | |
| | ±0.25pF | GRM0335C1H7R5CA01# | | | |
| 7.6pF | ±0.05pF | GRM0335C1H7R6WA01# | | | |
| | ±0.1pF | GRM0335C1H7R6BA01# | | | |
| | ±0.25pF | GRM0335C1H7R6CA01# | | | |

| T max. | Rated Voltage | TC Code | Cap. | Tol. | Part Number |
|--------|---------------|---------|-------|---------|--------------------|
| 0.33mm | 50Vdc | C0G | 6.3pF | ±0.05pF | GRM0335C1H6R3WA01# |
| | | | | ±0.1pF | GRM0335C1H6R3BA01# |
| | | | | ±0.25pF | GRM0335C1H6R3CA01# |
| | | | 6.4pF | ±0.05pF | GRM0335C1H6R4WA01# |
| | | | | ±0.1pF | GRM0335C1H6R4BA01# |
| | | | | ±0.25pF | GRM0335C1H6R4CA01# |
| | | | 6.5pF | ±0.05pF | GRM0335C1H6R5WA01# |
| | | | | ±0.1pF | GRM0335C1H6R5BA01# |
| | | | | ±0.25pF | GRM0335C1H6R5CA01# |
| | | | 6.6pF | ±0.05pF | GRM0335C1H6R6WA01# |
| | | | | ±0.1pF | GRM0335C1H6R6BA01# |
| | | | | ±0.25pF | GRM0335C1H6R6CA01# |
| | | | 6.7pF | ±0.05pF | GRM0335C1H6R7WA01# |
| | | | | ±0.1pF | GRM0335C1H6R7BA01# |
| | | | | ±0.25pF | GRM0335C1H6R7CA01# |
| | | | 6.8pF | ±0.05pF | GRM0335C1H6R8WA01# |
| | | | | ±0.1pF | GRM0335C1H6R8BA01# |
| | | | | ±0.25pF | GRM0335C1H6R8CA01# |
| | | | 6.9pF | ±0.05pF | GRM0335C1H6R9WA01# |
| | | | | ±0.1pF | GRM0335C1H6R9BA01# |
| | | | | ±0.25pF | GRM0335C1H6R9CA01# |
| | | | 7.0pF | ±0.05pF | GRM0335C1H7R0WA01# |
| | | | | ±0.1pF | GRM0335C1H7R0BA01# |
| | | | | ±0.25pF | GRM0335C1H7R0CA01# |
| | | | 7.1pF | ±0.05pF | GRM0335C1H7R1WA01# |
| | | | | ±0.1pF | GRM0335C1H7R1BA01# |
| | | | | ±0.25pF | GRM0335C1H7R1CA01# |
| | | | 7.2pF | ±0.05pF | GRM0335C1H7R2WA01# |
| | | | | ±0.1pF | GRM0335C1H7R2BA01# |
| | | | | ±0.25pF | GRM0335C1H7R2CA01# |
| | | | 7.3pF | ±0.05pF | GRM0335C1H7R3WA01# |
| | | | | ±0.1pF | GRM0335C1H7R3BA01# |
| | | | | ±0.25pF | GRM0335C1H7R3CA01# |
| | | | 7.4pF | ±0.05pF | GRM0335C1H7R4WA01# |
| | | | | ±0.1pF | GRM0335C1H7R4BA01# |
| | | | | ±0.25pF | GRM0335C1H7R4CA01# |
| | | | 7.5pF | ±0.05pF | GRM0335C1H7R5WA01# |
| | | | | ±0.1pF | GRM0335C1H7R5BA01# |
| | | | | ±0.25pF | GRM0335C1H7R5CA01# |
| | | | 7.6pF | ±0.05pF | GRM0335C1H7R6WA01# |
| | | | | ±0.1pF | GRM0335C1H7R6BA01# |
| | | | | ±0.25pF | GRM0335C1H7R6CA01# |

Part number # indicates the package specification code.

For General Purpose GRM Series
 Capacitor Array GNM Series
 Low ESL LLI Series
 High-Q Type GJM Series
 High Frequency GQM Series
 Monolithic Microchip GMA Series
 For Bonding GMD Series
 Product Information

GRM Series Temperature Compensating Type Part Number List

(→ ■ 0.6x0.3mm)

| T max. | Rated Voltage | TC Code | Cap. | Tol. | Part Number |
|--------|---------------|---------|-------|---------|--------------------|
| 0.33mm | 50Vdc | C0G | 7.6pF | ±0.25pF | GRM0335C1H7R6CA01# |
| | | | | ±0.5pF | GRM0335C1H7R6DA01# |
| | | | 7.7pF | ±0.05pF | GRM0335C1H7R7WA01# |
| | | | | ±0.1pF | GRM0335C1H7R7BA01# |
| | | | | ±0.25pF | GRM0335C1H7R7CA01# |
| | | | | ±0.5pF | GRM0335C1H7R7DA01# |
| | | | 7.8pF | ±0.05pF | GRM0335C1H7R8WA01# |
| | | | | ±0.1pF | GRM0335C1H7R8BA01# |
| | | | | ±0.25pF | GRM0335C1H7R8CA01# |
| | | | | ±0.5pF | GRM0335C1H7R8DA01# |
| | | | 7.9pF | ±0.05pF | GRM0335C1H7R9WA01# |
| | | | | ±0.1pF | GRM0335C1H7R9BA01# |
| | | | | ±0.25pF | GRM0335C1H7R9CA01# |
| | | | | ±0.5pF | GRM0335C1H7R9DA01# |
| | | | 8.0pF | ±0.05pF | GRM0335C1H8R0WA01# |
| | | | | ±0.1pF | GRM0335C1H8R0BA01# |
| | | | | ±0.25pF | GRM0335C1H8R0CA01# |
| | | | | ±0.5pF | GRM0335C1H8R0DA01# |
| | | | 8.1pF | ±0.05pF | GRM0335C1H8R1WA01# |
| | | | | ±0.1pF | GRM0335C1H8R1BA01# |
| | | | | ±0.25pF | GRM0335C1H8R1CA01# |
| | | | | ±0.5pF | GRM0335C1H8R1DA01# |
| | | | 8.2pF | ±0.05pF | GRM0335C1H8R2WA01# |
| | | | | ±0.1pF | GRM0335C1H8R2BA01# |
| | | | | ±0.25pF | GRM0335C1H8R2CA01# |
| | | | | ±0.5pF | GRM0335C1H8R2DA01# |
| | | | 8.3pF | ±0.05pF | GRM0335C1H8R3WA01# |
| | | | | ±0.1pF | GRM0335C1H8R3BA01# |
| | | | | ±0.25pF | GRM0335C1H8R3CA01# |
| | | | | ±0.5pF | GRM0335C1H8R3DA01# |
| | | | 8.4pF | ±0.05pF | GRM0335C1H8R4WA01# |
| | | | | ±0.1pF | GRM0335C1H8R4BA01# |
| | | | | ±0.25pF | GRM0335C1H8R4CA01# |
| | | | | ±0.5pF | GRM0335C1H8R4DA01# |
| | | | 8.5pF | ±0.05pF | GRM0335C1H8R5WA01# |
| | | | | ±0.1pF | GRM0335C1H8R5BA01# |
| | | | | ±0.25pF | GRM0335C1H8R5CA01# |
| | | | | ±0.5pF | GRM0335C1H8R5DA01# |
| | | | 8.6pF | ±0.05pF | GRM0335C1H8R6WA01# |
| | | | | ±0.1pF | GRM0335C1H8R6BA01# |
| | | | | ±0.25pF | GRM0335C1H8R6CA01# |
| | | | | ±0.5pF | GRM0335C1H8R6DA01# |
| | | | 8.7pF | ±0.05pF | GRM0335C1H8R7WA01# |
| | | | | ±0.1pF | GRM0335C1H8R7BA01# |
| | | | | ±0.25pF | GRM0335C1H8R7CA01# |
| | | | | ±0.5pF | GRM0335C1H8R7DA01# |
| | | | 8.8pF | ±0.05pF | GRM0335C1H8R8WA01# |
| | | | | ±0.1pF | GRM0335C1H8R8BA01# |
| | | | | ±0.25pF | GRM0335C1H8R8CA01# |
| | | | | ±0.5pF | GRM0335C1H8R8DA01# |
| | | | 8.9pF | ±0.05pF | GRM0335C1H8R9WA01# |
| | | | | ±0.1pF | GRM0335C1H8R9BA01# |
| | | | | ±0.25pF | GRM0335C1H8R9CA01# |
| | | | | ±0.5pF | GRM0335C1H8R9DA01# |

| T max. | Rated Voltage | TC Code | Cap. | Tol. | Part Number |
|--------|--------------------|--------------------|-------|---------|--------------------|
| 0.33mm | 50Vdc | C0G | 9.0pF | ±0.05pF | GRM0335C1H9R0WA01# |
| | | | | ±0.1pF | GRM0335C1H9R0BA01# |
| | | | | ±0.25pF | GRM0335C1H9R0CA01# |
| | | | | ±0.5pF | GRM0335C1H9R0DA01# |
| | | | 9.1pF | ±0.05pF | GRM0335C1H9R1WA01# |
| | | | | ±0.1pF | GRM0335C1H9R1BA01# |
| | | | | ±0.25pF | GRM0335C1H9R1CA01# |
| | | | 9.2pF | ±0.05pF | GRM0335C1H9R2WA01# |
| | | | | ±0.1pF | GRM0335C1H9R2BA01# |
| | | | | ±0.25pF | GRM0335C1H9R2CA01# |
| | | | 9.3pF | ±0.05pF | GRM0335C1H9R3WA01# |
| | | | | ±0.1pF | GRM0335C1H9R3BA01# |
| | | | | ±0.25pF | GRM0335C1H9R3CA01# |
| | | | 9.4pF | ±0.05pF | GRM0335C1H9R4WA01# |
| | | | | ±0.1pF | GRM0335C1H9R4BA01# |
| | | | | ±0.25pF | GRM0335C1H9R4CA01# |
| | | | 9.5pF | ±0.05pF | GRM0335C1H9R5WA01# |
| | | | | ±0.1pF | GRM0335C1H9R5BA01# |
| | | | | ±0.25pF | GRM0335C1H9R5CA01# |
| | | | 9.6pF | ±0.05pF | GRM0335C1H9R6WA01# |
| | | | | ±0.1pF | GRM0335C1H9R6BA01# |
| | | | | ±0.25pF | GRM0335C1H9R6CA01# |
| | | | 9.7pF | ±0.05pF | GRM0335C1H9R7WA01# |
| | | | | ±0.1pF | GRM0335C1H9R7BA01# |
| | | | | ±0.25pF | GRM0335C1H9R7CA01# |
| | | | 9.8pF | ±0.05pF | GRM0335C1H9R8WA01# |
| | | | | ±0.1pF | GRM0335C1H9R8BA01# |
| | | | | ±0.25pF | GRM0335C1H9R8CA01# |
| | | | 9.9pF | ±0.05pF | GRM0335C1H9R9WA01# |
| | | | | ±0.1pF | GRM0335C1H9R9BA01# |
| | | | | ±0.25pF | GRM0335C1H9R9CA01# |
| | | | 10pF | ±2% | GRM0335C1H100GA01# |
| | | | | ±5% | GRM0335C1H100JA01# |
| | | | 12pF | ±2% | GRM0335C1H120GA01# |
| | | | | ±5% | GRM0335C1H120JA01# |
| | | | 15pF | ±2% | GRM0335C1H150GA01# |
| | | | | ±5% | GRM0335C1H150JA01# |
| | | | 18pF | ±2% | GRM0335C1H180GA01# |
| | | | | ±5% | GRM0335C1H180JA01# |
| | | | 22pF | ±2% | GRM0335C1H220GA01# |
| | | | | ±5% | GRM0335C1H220JA01# |
| | | | 27pF | ±2% | GRM0335C1H270GA01# |
| ±5% | GRM0335C1H270JA01# | | | | |
| 33pF | ±2% | GRM0335C1H330GA01# | | | |
| | ±5% | GRM0335C1H330JA01# | | | |

Part number # indicates the package specification code.

GRM Series Temperature Compensating Type Part Number List

(→ ■ 0.6x0.3mm)

| T max. | Rated Voltage | TC Code | Cap. | Tol. | Part Number | |
|---------|--------------------|--------------------|---------|--------------------|--------------------|--------------------|
| 0.33mm | 50Vdc | C0G | 39pF | ±2% | GRM0335C1H390GA01# | |
| | | | | ±5% | GRM0335C1H390JA01# | |
| | | | 47pF | ±2% | GRM0335C1H470GA01# | |
| | | | | ±5% | GRM0335C1H470JA01# | |
| | | | 56pF | ±2% | GRM0335C1H560GA01# | |
| | | | | ±5% | GRM0335C1H560JA01# | |
| | | | 68pF | ±2% | GRM0335C1H680GA01# | |
| | | | | ±5% | GRM0335C1H680JA01# | |
| | | | 82pF | ±2% | GRM0335C1H820GA01# | |
| | | | | ±5% | GRM0335C1H820JA01# | |
| | | | 100pF | ±2% | GRM0335C1H101GA01# | |
| | | | | ±5% | GRM0335C1H101JA01# | |
| | | | | | GRM0335C1H101JA01# | |
| | | | CK | 0.1pF | ±0.05pF | GRM0334C1HR10WA01# |
| | | | | | ±0.1pF | GRM0334C1HR10BA01# |
| | | | | 0.2pF | ±0.05pF | GRM0334C1HR20WA01# |
| | | | | | ±0.1pF | GRM0334C1HR20BA01# |
| | | | | 0.3pF | ±0.05pF | GRM0334C1HR30WA01# |
| | | | | | ±0.1pF | GRM0334C1HR30BA01# |
| | | | | 0.4pF | ±0.05pF | GRM0334C1HR40WA01# |
| | | | | | ±0.1pF | GRM0334C1HR40BA01# |
| | | | | 0.5pF | ±0.05pF | GRM0334C1HR50WA01# |
| | | | | | ±0.1pF | GRM0334C1HR50BA01# |
| | | | | 0.6pF | ±0.05pF | GRM0334C1HR60WA01# |
| | | ±0.1pF | | | GRM0334C1HR60BA01# | |
| | | 0.7pF | | ±0.05pF | GRM0334C1HR70WA01# | |
| | | | | ±0.1pF | GRM0334C1HR70BA01# | |
| | | 0.8pF | | ±0.05pF | GRM0334C1HR80WA01# | |
| | | | | ±0.1pF | GRM0334C1HR80BA01# | |
| | | 0.9pF | | ±0.05pF | GRM0334C1HR90WA01# | |
| | | | | ±0.1pF | GRM0334C1HR90BA01# | |
| | | 1.0pF | | ±0.05pF | GRM0334C1H1R0WA01# | |
| | | | | ±0.1pF | GRM0334C1H1R0BA01# | |
| | | | | ±0.25pF | GRM0334C1H1R0CA01# | |
| | | 1.1pF | | ±0.05pF | GRM0334C1H1R1WA01# | |
| | | | | ±0.1pF | GRM0334C1H1R1BA01# | |
| | | | | ±0.25pF | GRM0334C1H1R1CA01# | |
| | | 1.2pF | ±0.05pF | GRM0334C1H1R2WA01# | | |
| | | | ±0.1pF | GRM0334C1H1R2BA01# | | |
| | | | ±0.25pF | GRM0334C1H1R2CA01# | | |
| | | 1.3pF | ±0.05pF | GRM0334C1H1R3WA01# | | |
| | | | ±0.1pF | GRM0334C1H1R3BA01# | | |
| | | | ±0.25pF | GRM0334C1H1R3CA01# | | |
| | | 1.4pF | ±0.05pF | GRM0334C1H1R4WA01# | | |
| | | | ±0.1pF | GRM0334C1H1R4BA01# | | |
| | | | ±0.25pF | GRM0334C1H1R4CA01# | | |
| | | 1.5pF | ±0.05pF | GRM0334C1H1R5WA01# | | |
| | | | ±0.1pF | GRM0334C1H1R5BA01# | | |
| ±0.25pF | GRM0334C1H1R5CA01# | | | | | |
| 1.6pF | ±0.05pF | GRM0334C1H1R6WA01# | | | | |
| | ±0.1pF | GRM0334C1H1R6BA01# | | | | |
| | ±0.25pF | GRM0334C1H1R6CA01# | | | | |
| 1.7pF | ±0.05pF | GRM0334C1H1R7WA01# | | | | |
| | ±0.1pF | GRM0334C1H1R7BA01# | | | | |
| | ±0.25pF | GRM0334C1H1R7CA01# | | | | |

| T max. | Rated Voltage | TC Code | Cap. | Tol. | Part Number | |
|--------|---------------|--------------------|---------|--------------------|--------------------|--------------------|
| 0.33mm | 50Vdc | CK | 1.8pF | ±0.05pF | GRM0334C1H1R8WA01# | |
| | | | | ±0.1pF | GRM0334C1H1R8BA01# | |
| | | | | ±0.25pF | GRM0334C1H1R8CA01# | |
| | | | 1.9pF | ±0.05pF | GRM0334C1H1R9WA01# | |
| | | | | ±0.1pF | GRM0334C1H1R9BA01# | |
| | | | | ±0.25pF | GRM0334C1H1R9CA01# | |
| | | | 2.0pF | ±0.05pF | GRM0334C1H2R0WA01# | |
| | | | | ±0.1pF | GRM0334C1H2R0BA01# | |
| | | | | ±0.25pF | GRM0334C1H2R0CA01# | |
| | | | CJ | 2.1pF | ±0.05pF | GRM0333C1H2R1WA01# |
| | | | | | ±0.1pF | GRM0333C1H2R1BA01# |
| | | | | | ±0.25pF | GRM0333C1H2R1CA01# |
| | | | 2.2pF | ±0.05pF | GRM0333C1H2R2WA01# | |
| | | | | ±0.1pF | GRM0333C1H2R2BA01# | |
| | | | | ±0.25pF | GRM0333C1H2R2CA01# | |
| | | | 2.3pF | ±0.05pF | GRM0333C1H2R3WA01# | |
| | | | | ±0.1pF | GRM0333C1H2R3BA01# | |
| | | | | ±0.25pF | GRM0333C1H2R3CA01# | |
| | | | 2.4pF | ±0.05pF | GRM0333C1H2R4WA01# | |
| | | | | ±0.1pF | GRM0333C1H2R4BA01# | |
| | | | | ±0.25pF | GRM0333C1H2R4CA01# | |
| | | | 2.5pF | ±0.05pF | GRM0333C1H2R5WA01# | |
| | | | | ±0.1pF | GRM0333C1H2R5BA01# | |
| | | | | ±0.25pF | GRM0333C1H2R5CA01# | |
| | | 2.6pF | ±0.05pF | GRM0333C1H2R6WA01# | | |
| | | | ±0.1pF | GRM0333C1H2R6BA01# | | |
| | | | ±0.25pF | GRM0333C1H2R6CA01# | | |
| | | 2.7pF | ±0.05pF | GRM0333C1H2R7WA01# | | |
| | | | ±0.1pF | GRM0333C1H2R7BA01# | | |
| | | | ±0.25pF | GRM0333C1H2R7CA01# | | |
| | | 2.8pF | ±0.05pF | GRM0333C1H2R8WA01# | | |
| | | | ±0.1pF | GRM0333C1H2R8BA01# | | |
| | | | ±0.25pF | GRM0333C1H2R8CA01# | | |
| | | 2.9pF | ±0.05pF | GRM0333C1H2R9WA01# | | |
| | | | ±0.1pF | GRM0333C1H2R9BA01# | | |
| | | | ±0.25pF | GRM0333C1H2R9CA01# | | |
| | | 3.0pF | ±0.05pF | GRM0333C1H3R0WA01# | | |
| | | | ±0.1pF | GRM0333C1H3R0BA01# | | |
| | | | ±0.25pF | GRM0333C1H3R0CA01# | | |
| | | 3.1pF | ±0.05pF | GRM0333C1H3R1WA01# | | |
| | | | ±0.1pF | GRM0333C1H3R1BA01# | | |
| | | | ±0.25pF | GRM0333C1H3R1CA01# | | |
| | | 3.2pF | ±0.05pF | GRM0333C1H3R2WA01# | | |
| | | | ±0.1pF | GRM0333C1H3R2BA01# | | |
| | | | ±0.25pF | GRM0333C1H3R2CA01# | | |
| | | 3.3pF | ±0.05pF | GRM0333C1H3R3WA01# | | |
| | | | ±0.1pF | GRM0333C1H3R3BA01# | | |
| | | | ±0.25pF | GRM0333C1H3R3CA01# | | |
| 3.4pF | ±0.05pF | GRM0333C1H3R4WA01# | | | | |
| | ±0.1pF | GRM0333C1H3R4BA01# | | | | |
| | ±0.25pF | GRM0333C1H3R4CA01# | | | | |
| 3.5pF | ±0.05pF | GRM0333C1H3R5WA01# | | | | |
| | ±0.1pF | GRM0333C1H3R5BA01# | | | | |
| | ±0.25pF | GRM0333C1H3R5CA01# | | | | |

Part number # indicates the package specification code.

For General Purpose GRM Series
 Capacitor Array GNM Series
 Low ESL LLI Series
 High-Q Type GJM Series
 High Frequency GQM Series
 Monolithic Microchip GMA Series
 For Bonding GMD Series
 Product Information

GRM Series Temperature Compensating Type Part Number List

(→ ■ 0.6x0.3mm)

| T max. | Rated Voltage | TC Code | Cap. | Tol. | Part Number | |
|--------|---------------|---------|---------|--------------------|--------------------|--------------------|
| 0.33mm | 50Vdc | CJ | 3.6pF | ±0.05pF | GRM0333C1H3R6WA01# | |
| | | | | ±0.1pF | GRM0333C1H3R6BA01# | |
| | | | | ±0.25pF | GRM0333C1H3R6CA01# | |
| | | | 3.7pF | ±0.05pF | GRM0333C1H3R7WA01# | |
| | | | | ±0.1pF | GRM0333C1H3R7BA01# | |
| | | | | ±0.25pF | GRM0333C1H3R7CA01# | |
| | | | 3.8pF | ±0.05pF | GRM0333C1H3R8WA01# | |
| | | | | ±0.1pF | GRM0333C1H3R8BA01# | |
| | | | | ±0.25pF | GRM0333C1H3R8CA01# | |
| | | | 3.9pF | ±0.05pF | GRM0333C1H3R9WA01# | |
| | | | | ±0.1pF | GRM0333C1H3R9BA01# | |
| | | | | ±0.25pF | GRM0333C1H3R9CA01# | |
| | | | CH | 4.0pF | ±0.05pF | GRM0332C1H4R0WA01# |
| | | | | | ±0.1pF | GRM0332C1H4R0BA01# |
| | | | | | ±0.25pF | GRM0332C1H4R0CA01# |
| | | | | 4.1pF | ±0.05pF | GRM0332C1H4R1WA01# |
| | | | | | ±0.1pF | GRM0332C1H4R1BA01# |
| | | | | | ±0.25pF | GRM0332C1H4R1CA01# |
| | | 4.2pF | | ±0.05pF | GRM0332C1H4R2WA01# | |
| | | | | ±0.1pF | GRM0332C1H4R2BA01# | |
| | | | | ±0.25pF | GRM0332C1H4R2CA01# | |
| | | 4.3pF | | ±0.05pF | GRM0332C1H4R3WA01# | |
| | | | | ±0.1pF | GRM0332C1H4R3BA01# | |
| | | | | ±0.25pF | GRM0332C1H4R3CA01# | |
| | | 4.4pF | | ±0.05pF | GRM0332C1H4R4WA01# | |
| | | | | ±0.1pF | GRM0332C1H4R4BA01# | |
| | | | | ±0.25pF | GRM0332C1H4R4CA01# | |
| | | 4.5pF | | ±0.05pF | GRM0332C1H4R5WA01# | |
| | | | | ±0.1pF | GRM0332C1H4R5BA01# | |
| | | | | ±0.25pF | GRM0332C1H4R5CA01# | |
| | | 4.6pF | | ±0.05pF | GRM0332C1H4R6WA01# | |
| | | | | ±0.1pF | GRM0332C1H4R6BA01# | |
| | | | | ±0.25pF | GRM0332C1H4R6CA01# | |
| | | 4.7pF | | ±0.05pF | GRM0332C1H4R7WA01# | |
| | | | | ±0.1pF | GRM0332C1H4R7BA01# | |
| | | | | ±0.25pF | GRM0332C1H4R7CA01# | |
| | | 4.8pF | | ±0.05pF | GRM0332C1H4R8WA01# | |
| | | | | ±0.1pF | GRM0332C1H4R8BA01# | |
| | | | | ±0.25pF | GRM0332C1H4R8CA01# | |
| | | 4.9pF | | ±0.05pF | GRM0332C1H4R9WA01# | |
| | | | | ±0.1pF | GRM0332C1H4R9BA01# | |
| | | | | ±0.25pF | GRM0332C1H4R9CA01# | |
| | | 5.0pF | | ±0.05pF | GRM0332C1H5R0WA01# | |
| | | | | ±0.1pF | GRM0332C1H5R0BA01# | |
| | | | | ±0.25pF | GRM0332C1H5R0CA01# | |
| | | 5.1pF | | ±0.05pF | GRM0332C1H5R1WA01# | |
| | | | | ±0.1pF | GRM0332C1H5R1BA01# | |
| | | | | ±0.25pF | GRM0332C1H5R1CA01# | |
| | | | ±0.5pF | GRM0332C1H5R1DA01# | | |
| | | 5.2pF | ±0.05pF | GRM0332C1H5R2WA01# | | |
| | | | ±0.1pF | GRM0332C1H5R2BA01# | | |
| | | | ±0.25pF | GRM0332C1H5R2CA01# | | |
| | | | ±0.5pF | GRM0332C1H5R2DA01# | | |
| | | 5.3pF | ±0.05pF | GRM0332C1H5R3WA01# | | |

| T max. | Rated Voltage | TC Code | Cap. | Tol. | Part Number |
|--------|---------------|---------|-------|---------|--------------------|
| 0.33mm | 50Vdc | CH | 5.3pF | ±0.1pF | GRM0332C1H5R3BA01# |
| | | | | ±0.25pF | GRM0332C1H5R3CA01# |
| | | | | ±0.5pF | GRM0332C1H5R3DA01# |
| | | | 5.4pF | ±0.05pF | GRM0332C1H5R4WA01# |
| | | | | ±0.1pF | GRM0332C1H5R4BA01# |
| | | | | ±0.25pF | GRM0332C1H5R4CA01# |
| | | | 5.5pF | ±0.05pF | GRM0332C1H5R5WA01# |
| | | | | ±0.1pF | GRM0332C1H5R5BA01# |
| | | | | ±0.25pF | GRM0332C1H5R5CA01# |
| | | | 5.6pF | ±0.05pF | GRM0332C1H5R6WA01# |
| | | | | ±0.1pF | GRM0332C1H5R6BA01# |
| | | | | ±0.25pF | GRM0332C1H5R6CA01# |
| | | | 5.7pF | ±0.05pF | GRM0332C1H5R7WA01# |
| | | | | ±0.1pF | GRM0332C1H5R7BA01# |
| | | | | ±0.25pF | GRM0332C1H5R7CA01# |
| | | | 5.8pF | ±0.05pF | GRM0332C1H5R8WA01# |
| | | | | ±0.1pF | GRM0332C1H5R8BA01# |
| | | | | ±0.25pF | GRM0332C1H5R8CA01# |
| | | | 5.9pF | ±0.05pF | GRM0332C1H5R9WA01# |
| | | | | ±0.1pF | GRM0332C1H5R9BA01# |
| | | | | ±0.25pF | GRM0332C1H5R9CA01# |
| | | | 6.0pF | ±0.05pF | GRM0332C1H6R0WA01# |
| | | | | ±0.1pF | GRM0332C1H6R0BA01# |
| | | | | ±0.25pF | GRM0332C1H6R0CA01# |
| | | | 6.1pF | ±0.05pF | GRM0332C1H6R1WA01# |
| | | | | ±0.1pF | GRM0332C1H6R1BA01# |
| | | | | ±0.25pF | GRM0332C1H6R1CA01# |
| | | | 6.2pF | ±0.05pF | GRM0332C1H6R2WA01# |
| | | | | ±0.1pF | GRM0332C1H6R2BA01# |
| | | | | ±0.25pF | GRM0332C1H6R2CA01# |
| | | | 6.3pF | ±0.05pF | GRM0332C1H6R3WA01# |
| | | | | ±0.1pF | GRM0332C1H6R3BA01# |
| | | | | ±0.25pF | GRM0332C1H6R3CA01# |
| | | | 6.4pF | ±0.05pF | GRM0332C1H6R4WA01# |
| | | | | ±0.1pF | GRM0332C1H6R4BA01# |
| | | | | ±0.25pF | GRM0332C1H6R4CA01# |
| | | | 6.5pF | ±0.05pF | GRM0332C1H6R5WA01# |
| | | | | ±0.1pF | GRM0332C1H6R5BA01# |
| | | | | ±0.25pF | GRM0332C1H6R5CA01# |
| | | | 6.6pF | ±0.05pF | GRM0332C1H6R6WA01# |
| | | | | ±0.1pF | GRM0332C1H6R6BA01# |
| | | | | ±0.25pF | GRM0332C1H6R6CA01# |

Part number # indicates the package specification code.

GRM Series Temperature Compensating Type Part Number List

(→ ■ 0.6x0.3mm)

| T max. | Rated Voltage | TC Code | Cap. | Tol. | Part Number | |
|--------|--------------------|--------------------|---------|--------------------|--------------------|--------------------|
| 0.33mm | 50Vdc | CH | 6.6pF | ±0.5pF | GRM0332C1H6R6DA01# | |
| | | | | ±0.05pF | GRM0332C1H6R7WA01# | |
| | | | | | ±0.1pF | GRM0332C1H6R7BA01# |
| | | | ±0.25pF | | GRM0332C1H6R7CA01# | |
| | | | ±0.5pF | GRM0332C1H6R7DA01# | | |
| | | | | 6.8pF | ±0.05pF | GRM0332C1H6R8WA01# |
| | | | | | ±0.1pF | GRM0332C1H6R8BA01# |
| | | | ±0.25pF | | GRM0332C1H6R8CA01# | |
| | | | ±0.5pF | GRM0332C1H6R8DA01# | | |
| | | | 6.9pF | ±0.05pF | GRM0332C1H6R9WA01# | |
| | | | | ±0.1pF | GRM0332C1H6R9BA01# | |
| | | | | ±0.25pF | GRM0332C1H6R9CA01# | |
| | | | ±0.5pF | GRM0332C1H6R9DA01# | | |
| | | | 7.0pF | ±0.05pF | GRM0332C1H7R0WA01# | |
| | | | | ±0.1pF | GRM0332C1H7R0BA01# | |
| | | | | ±0.25pF | GRM0332C1H7R0CA01# | |
| | | | ±0.5pF | GRM0332C1H7R0DA01# | | |
| | | | 7.1pF | ±0.05pF | GRM0332C1H7R1WA01# | |
| | | | | ±0.1pF | GRM0332C1H7R1BA01# | |
| | | | | ±0.25pF | GRM0332C1H7R1CA01# | |
| | | | ±0.5pF | GRM0332C1H7R1DA01# | | |
| | | | 7.2pF | ±0.05pF | GRM0332C1H7R2WA01# | |
| | | | | ±0.1pF | GRM0332C1H7R2BA01# | |
| | | | | ±0.25pF | GRM0332C1H7R2CA01# | |
| | | | ±0.5pF | GRM0332C1H7R2DA01# | | |
| | | | 7.3pF | ±0.05pF | GRM0332C1H7R3WA01# | |
| | | | | ±0.1pF | GRM0332C1H7R3BA01# | |
| | | | | ±0.25pF | GRM0332C1H7R3CA01# | |
| | | | ±0.5pF | GRM0332C1H7R3DA01# | | |
| | | | 7.4pF | ±0.05pF | GRM0332C1H7R4WA01# | |
| | | | | ±0.1pF | GRM0332C1H7R4BA01# | |
| | | | | ±0.25pF | GRM0332C1H7R4CA01# | |
| | | | ±0.5pF | GRM0332C1H7R4DA01# | | |
| | | | 7.5pF | ±0.05pF | GRM0332C1H7R5WA01# | |
| | | | | ±0.1pF | GRM0332C1H7R5BA01# | |
| | | | | ±0.25pF | GRM0332C1H7R5CA01# | |
| | | | ±0.5pF | GRM0332C1H7R5DA01# | | |
| | | | 7.6pF | ±0.05pF | GRM0332C1H7R6WA01# | |
| | | | | ±0.1pF | GRM0332C1H7R6BA01# | |
| | | | | ±0.25pF | GRM0332C1H7R6CA01# | |
| | | | ±0.5pF | GRM0332C1H7R6DA01# | | |
| | | | 7.7pF | ±0.05pF | GRM0332C1H7R7WA01# | |
| | | | | ±0.1pF | GRM0332C1H7R7BA01# | |
| | | | | ±0.25pF | GRM0332C1H7R7CA01# | |
| | | | ±0.5pF | GRM0332C1H7R7DA01# | | |
| | | | 7.8pF | ±0.05pF | GRM0332C1H7R8WA01# | |
| | | | | ±0.1pF | GRM0332C1H7R8BA01# | |
| | | | | ±0.25pF | GRM0332C1H7R8CA01# | |
| ±0.5pF | GRM0332C1H7R8DA01# | | | | | |
| 7.9pF | ±0.05pF | GRM0332C1H7R9WA01# | | | | |
| | ±0.1pF | GRM0332C1H7R9BA01# | | | | |
| | ±0.25pF | GRM0332C1H7R9CA01# | | | | |
| ±0.5pF | GRM0332C1H7R9DA01# | | | | | |
| 8.0pF | ±0.05pF | GRM0332C1H8R0WA01# | | | | |

| T max. | Rated Voltage | TC Code | Cap. | Tol. | Part Number |
|---------|--------------------|--------------------|--------|--------------------|--------------------|
| 0.33mm | 50Vdc | CH | 8.0pF | ±0.1pF | GRM0332C1H8R0BA01# |
| | | | | ±0.25pF | GRM0332C1H8R0CA01# |
| | | | | ±0.5pF | GRM0332C1H8R0DA01# |
| | | | 8.1pF | ±0.05pF | GRM0332C1H8R1WA01# |
| | | | | ±0.1pF | GRM0332C1H8R1BA01# |
| | | | | ±0.25pF | GRM0332C1H8R1CA01# |
| | | | ±0.5pF | GRM0332C1H8R1DA01# | |
| | | | 8.2pF | ±0.05pF | GRM0332C1H8R2WA01# |
| | | | | ±0.1pF | GRM0332C1H8R2BA01# |
| | | | | ±0.25pF | GRM0332C1H8R2CA01# |
| | | | ±0.5pF | GRM0332C1H8R2DA01# | |
| | | | 8.3pF | ±0.05pF | GRM0332C1H8R3WA01# |
| | | | | ±0.1pF | GRM0332C1H8R3BA01# |
| | | | | ±0.25pF | GRM0332C1H8R3CA01# |
| | | | ±0.5pF | GRM0332C1H8R3DA01# | |
| | | | 8.4pF | ±0.05pF | GRM0332C1H8R4WA01# |
| | | | | ±0.1pF | GRM0332C1H8R4BA01# |
| | | | | ±0.25pF | GRM0332C1H8R4CA01# |
| | | | ±0.5pF | GRM0332C1H8R4DA01# | |
| | | | 8.5pF | ±0.05pF | GRM0332C1H8R5WA01# |
| | | | | ±0.1pF | GRM0332C1H8R5BA01# |
| | | | | ±0.25pF | GRM0332C1H8R5CA01# |
| | | | ±0.5pF | GRM0332C1H8R5DA01# | |
| | | | 8.6pF | ±0.05pF | GRM0332C1H8R6WA01# |
| | | | | ±0.1pF | GRM0332C1H8R6BA01# |
| | | | | ±0.25pF | GRM0332C1H8R6CA01# |
| | | | ±0.5pF | GRM0332C1H8R6DA01# | |
| | | | 8.7pF | ±0.05pF | GRM0332C1H8R7WA01# |
| | | | | ±0.1pF | GRM0332C1H8R7BA01# |
| | | | | ±0.25pF | GRM0332C1H8R7CA01# |
| | | | ±0.5pF | GRM0332C1H8R7DA01# | |
| | | | 8.8pF | ±0.05pF | GRM0332C1H8R8WA01# |
| | | | | ±0.1pF | GRM0332C1H8R8BA01# |
| | | | | ±0.25pF | GRM0332C1H8R8CA01# |
| | | | ±0.5pF | GRM0332C1H8R8DA01# | |
| | | | 8.9pF | ±0.05pF | GRM0332C1H8R9WA01# |
| | | | | ±0.1pF | GRM0332C1H8R9BA01# |
| | | | | ±0.25pF | GRM0332C1H8R9CA01# |
| | | | ±0.5pF | GRM0332C1H8R9DA01# | |
| | | | 9.0pF | ±0.05pF | GRM0332C1H9R0WA01# |
| | | | | ±0.1pF | GRM0332C1H9R0BA01# |
| | | | | ±0.25pF | GRM0332C1H9R0CA01# |
| | | | ±0.5pF | GRM0332C1H9R0DA01# | |
| | | | 9.1pF | ±0.05pF | GRM0332C1H9R1WA01# |
| | | | | ±0.1pF | GRM0332C1H9R1BA01# |
| | | | | ±0.25pF | GRM0332C1H9R1CA01# |
| | | | ±0.5pF | GRM0332C1H9R1DA01# | |
| | | | 9.2pF | ±0.05pF | GRM0332C1H9R2WA01# |
| ±0.1pF | GRM0332C1H9R2BA01# | | | | |
| ±0.25pF | GRM0332C1H9R2CA01# | | | | |
| ±0.5pF | GRM0332C1H9R2DA01# | | | | |
| 9.3pF | ±0.05pF | GRM0332C1H9R3WA01# | | | |
| | ±0.1pF | GRM0332C1H9R3BA01# | | | |
| | ±0.25pF | GRM0332C1H9R3CA01# | | | |

Part number # indicates the package specification code.

For General Purpose GRM Series

Capacitor Array GNM Series

Low ESL LLI Series

High-Q Type GJM Series

High Frequency GQM Series

Monolithic Microchip GMA Series

For Bonding GMD Series

Product Information

GRM Series Temperature Compensating Type Part Number List

(→ ■ 0.6x0.3mm)

| T max. | Rated Voltage | TC Code | Cap. | Tol. | Part Number | T max. | Rated Voltage | TC Code | Cap. | Tol. | Part Number | | |
|--------|--------------------|---------|--------------------|--------------------|--------------------|--------|--------------------|--------------------|--------------------|--------------------|--------------------|--------------------|--------------------|
| 0.33mm | 50Vdc | CH | 9.3pF | ±0.5pF | GRM0332C1H9R3DA01# | 0.33mm | 50Vdc | UJ | 4.0pF | ±0.25pF | GRM0333U1H4R0CD01# | | |
| | | | | ±0.05pF | GRM0332C1H9R4WA01# | | | | | 5.0pF | ±0.25pF | GRM0333U1H5R0CD01# | |
| | | | ±0.1pF | GRM0332C1H9R4BA01# | 6.0pF | | | | ±0.5pF | | GRM0333U1H6R0DD01# | | |
| | | | ±0.25pF | GRM0332C1H9R4CA01# | | | | | 7.0pF | ±0.5pF | GRM0333U1H7R0DD01# | | |
| | | | ±0.5pF | GRM0332C1H9R4DA01# | 8.0pF | | | | | ±0.5pF | GRM0333U1H8R0DD01# | | |
| | | | 9.5pF | ±0.05pF | | | | | GRM0332C1H9R5WA01# | 9.0pF | ±0.5pF | GRM0333U1H9R0DD01# | |
| | | | | ±0.1pF | | | | | GRM0332C1H9R5BA01# | | 10pF | ±5% | GRM0333U1H100JD01# |
| | | | | ±0.25pF | GRM0332C1H9R5CA01# | | | | 12pF | | | ±5% | GRM0333U1H120JD01# |
| | | | ±0.5pF | GRM0332C1H9R5DA01# | 15pF | | | | | ±5% | GRM0333U1H150JD01# | | |
| | | | | 9.6pF | | | | | ±0.05pF | GRM0332C1H9R6WA01# | 25Vdc | R2H | 1.0pF |
| | | | ±0.1pF | | GRM0332C1H9R6BA01# | | | | 2.0pF | ±0.25pF | | | |
| | | | ±0.25pF | | GRM0332C1H9R6CA01# | | | | | 3.0pF | | | ±0.25pF |
| | | | ±0.5pF | | GRM0332C1H9R6DA01# | | | 4.0pF | ±0.25pF | | | | GRM0336R1E4R0CD01# |
| | | | 9.7pF | ±0.05pF | GRM0332C1H9R7WA01# | | | | 5.0pF | ±0.25pF | GRM0336R1E5R0CD01# | | |
| | | | | ±0.1pF | GRM0332C1H9R7BA01# | | | | | 6.0pF | ±0.5pF | | GRM0336R1E6R0DD01# |
| | | | | ±0.25pF | GRM0332C1H9R7CA01# | | | 7.0pF | | | ±0.5pF | | GRM0336R1E7R0DD01# |
| | | | ±0.5pF | GRM0332C1H9R7DA01# | 8.0pF | | | | ±0.5pF | GRM0336R1E8R0DD01# | | | |
| | | | | 9.8pF | | | | ±0.05pF | GRM0332C1H9R8WA01# | 9.0pF | ±0.5pF | | GRM0336R1E9R0DD01# |
| | | | ±0.1pF | | GRM0332C1H9R8BA01# | | | 10pF | ±5% | | GRM0336R1E100JD01# | | |
| | | | ±0.25pF | | GRM0332C1H9R8CA01# | | | | 12pF | | ±5% | | GRM0336R1E120JD01# |
| | | | ±0.5pF | | GRM0332C1H9R8DA01# | | | 15pF | | | ±5% | | GRM0336R1E150JD01# |
| | | | 9.9pF | ±0.05pF | GRM0332C1H9R9WA01# | | | | 18pF | ±5% | GRM0336R1E180JD01# | | |
| | | | | ±0.1pF | GRM0332C1H9R9BA01# | | | | | 22pF | ±5% | GRM0336R1E220JD01# | |
| | | | | ±0.25pF | GRM0332C1H9R9CA01# | | | 27pF | | | ±5% | GRM0336R1E270JD01# | |
| | | | ±0.5pF | GRM0332C1H9R9DA01# | 33pF | | | | ±5% | GRM0336R1E330JD01# | | | |
| | | | | 10pF | | | | ±2% | GRM0332C1H100GA01# | 39pF | ±5% | GRM0336R1E390JD01# | |
| | | | ±5% | | GRM0332C1H100JA01# | | | 47pF | ±5% | | GRM0336R1E470JD01# | | |
| | | | 12pF | ±2% | GRM0332C1H120GA01# | | | | 56pF | ±5% | GRM0336R1E560JD01# | | |
| | | | | ±5% | GRM0332C1H120JA01# | | | 68pF | | ±5% | GRM0336R1E680JD01# | | |
| | | | 15pF | ±2% | GRM0332C1H150GA01# | | | | 82pF | ±5% | GRM0336R1E820JD01# | | |
| | | | | ±5% | GRM0332C1H150JA01# | | | 100pF | | ±5% | GRM0336R1E101JD01# | | |
| | | | 18pF | ±2% | GRM0332C1H180GA01# | | | | RK | 1.0pF | ±0.25pF | GRM0334R1E1R0CD01# | |
| | | | | ±5% | GRM0332C1H180JA01# | | | 2.0pF | | | ±0.25pF | GRM0334R1E2R0CD01# | |
| | | | 22pF | ±2% | GRM0332C1H220GA01# | | | | RJ | 3.0pF | ±0.25pF | GRM0333R1E3R0CD01# | |
| | | | | ±5% | GRM0332C1H220JA01# | | | RH | | | 4.0pF | ±0.25pF | GRM0332R1E4R0CD01# |
| | | | 27pF | ±2% | GRM0332C1H270GA01# | | | | 5.0pF | ±0.25pF | | GRM0332R1E5R0CD01# | |
| | | | | ±5% | GRM0332C1H270JA01# | | | | | 6.0pF | ±0.5pF | GRM0332R1E6R0DD01# | |
| | | | 33pF | ±2% | GRM0332C1H330GA01# | | | 7.0pF | ±0.5pF | | GRM0332R1E7R0DD01# | | |
| | | | | ±5% | GRM0332C1H330JA01# | | | | 8.0pF | ±0.5pF | GRM0332R1E8R0DD01# | | |
| | | | 39pF | ±2% | GRM0332C1H390GA01# | | | 9.0pF | | ±0.5pF | GRM0332R1E9R0DD01# | | |
| | | | | ±5% | GRM0332C1H390JA01# | | | | 10pF | ±5% | GRM0332R1E100JD01# | | |
| | | | 47pF | ±2% | GRM0332C1H470GA01# | | | 12pF | | ±5% | GRM0332R1E120JD01# | | |
| | | | | ±5% | GRM0332C1H470JA01# | | | | 15pF | ±5% | GRM0332R1E150JD01# | | |
| | | | 56pF | ±2% | GRM0332C1H560GA01# | | | 18pF | | ±5% | GRM0332R1E180JD01# | | |
| | | | | ±5% | GRM0332C1H560JA01# | | | | 22pF | ±5% | GRM0332R1E220JD01# | | |
| | | | 68pF | ±2% | GRM0332C1H680GA01# | | | 27pF | | ±5% | GRM0332R1E270JD01# | | |
| | | | | ±5% | GRM0332C1H680JA01# | | | | 33pF | ±5% | GRM0332R1E330JD01# | | |
| | | | 82pF | ±2% | GRM0332C1H820GA01# | | | 39pF | | ±5% | GRM0332R1E390JD01# | | |
| | | ±5% | | GRM0332C1H820JA01# | 47pF | | | | ±5% | GRM0332R1E470JD01# | | | |
| | | 100pF | ±2% | GRM0332C1H101GA01# | | | | 56pF | ±5% | GRM0332R1E560JD01# | | | |
| ±5% | GRM0332C1H101JA01# | | 68pF | ±5% | GRM0332R1E680JD01# | | | | | | | | |
| UK | 1.0pF | ±0.25pF | | GRM0334U1H1R0CD01# | 82pF | ±5% | GRM0332R1E820JD01# | | | | | | |
| | 2.0pF | ±0.25pF | GRM0334U1H2R0CD01# | 100pF | | ±5% | GRM0332R1E101JD01# | | | | | | |
| UJ | 3.0pF | ±0.25pF | GRM0333U1H3R0CD01# | | S2H | 1.0pF | ±0.25pF | GRM0336S1E1R0CD01# | | | | | |

Part number # indicates the package specification code.

GRM Series Temperature Compensating Type Part Number List

(→ ■ 0.6x0.3mm)

| T max. | Rated Voltage | TC Code | Cap. | Tol. | Part Number | |
|--------|---------------|---------|-------|--------------------|--------------------|--------------------|
| 0.33mm | 25Vdc | S2H | 2.0pF | ±0.25pF | GRM0336S1E2R0CD01# | |
| | | | 3.0pF | ±0.25pF | GRM0336S1E3R0CD01# | |
| | | | 4.0pF | ±0.25pF | GRM0336S1E4R0CD01# | |
| | | | 5.0pF | ±0.25pF | GRM0336S1E5R0CD01# | |
| | | | 6.0pF | ±0.5pF | GRM0336S1E6R0DD01# | |
| | | | 7.0pF | ±0.5pF | GRM0336S1E7R0DD01# | |
| | | | 8.0pF | ±0.5pF | GRM0336S1E8R0DD01# | |
| | | | 9.0pF | ±0.5pF | GRM0336S1E9R0DD01# | |
| | | | 10pF | ±5% | GRM0336S1E100JD01# | |
| | | | 12pF | ±5% | GRM0336S1E120JD01# | |
| | | | 15pF | ±5% | GRM0336S1E150JD01# | |
| | | | 18pF | ±5% | GRM0336S1E180JD01# | |
| | | | 22pF | ±5% | GRM0336S1E220JD01# | |
| | | | 27pF | ±5% | GRM0336S1E270JD01# | |
| | | | 33pF | ±5% | GRM0336S1E330JD01# | |
| | | | 39pF | ±5% | GRM0336S1E390JD01# | |
| | | | 47pF | ±5% | GRM0336S1E470JD01# | |
| | | | 56pF | ±5% | GRM0336S1E560JD01# | |
| | | | 68pF | ±5% | GRM0336S1E680JD01# | |
| | | | 82pF | ±5% | GRM0336S1E820JD01# | |
| | | | 100pF | ±5% | GRM0336S1E101JD01# | |
| | | | SK | 1.0pF | ±0.25pF | GRM0334S1E1R0CD01# |
| | | | 2.0pF | ±0.25pF | GRM0334S1E2R0CD01# | |
| | | | SJ | 3.0pF | ±0.25pF | GRM0333S1E3R0CD01# |
| | | | SH | 4.0pF | ±0.25pF | GRM0332S1E4R0CD01# |
| | | | | 5.0pF | ±0.25pF | GRM0332S1E5R0CD01# |
| | | | | 6.0pF | ±0.5pF | GRM0332S1E6R0DD01# |
| | | | | 7.0pF | ±0.5pF | GRM0332S1E7R0DD01# |
| | | | | 8.0pF | ±0.5pF | GRM0332S1E8R0DD01# |
| | | | | 9.0pF | ±0.5pF | GRM0332S1E9R0DD01# |
| | | | | 10pF | ±5% | GRM0332S1E100JD01# |
| | | | | 12pF | ±5% | GRM0332S1E120JD01# |
| | | | | 15pF | ±5% | GRM0332S1E150JD01# |
| | | | | 18pF | ±5% | GRM0332S1E180JD01# |
| | | | | 22pF | ±5% | GRM0332S1E220JD01# |
| | | | | 27pF | ±5% | GRM0332S1E270JD01# |
| | | | | 33pF | ±5% | GRM0332S1E330JD01# |
| | | | | 39pF | ±5% | GRM0332S1E390JD01# |
| | | | | 47pF | ±5% | GRM0332S1E470JD01# |
| | | | | 56pF | ±5% | GRM0332S1E560JD01# |
| | | 68pF | | ±5% | GRM0332S1E680JD01# | |
| | | 82pF | | ±5% | GRM0332S1E820JD01# | |
| | | 100pF | ±5% | GRM0332S1E101JD01# | | |
| | | T2H | 1.0pF | ±0.25pF | GRM0336T1E1R0CD01# | |
| | | | 2.0pF | ±0.25pF | GRM0336T1E2R0CD01# | |
| | | | 3.0pF | ±0.25pF | GRM0336T1E3R0CD01# | |
| | | | 4.0pF | ±0.25pF | GRM0336T1E4R0CD01# | |
| | | | 5.0pF | ±0.25pF | GRM0336T1E5R0CD01# | |
| | | | 6.0pF | ±0.5pF | GRM0336T1E6R0DD01# | |
| | | | 7.0pF | ±0.5pF | GRM0336T1E7R0DD01# | |
| | | | 8.0pF | ±0.5pF | GRM0336T1E8R0DD01# | |
| | | | 9.0pF | ±0.5pF | GRM0336T1E9R0DD01# | |
| | | | 10pF | ±5% | GRM0336T1E100JD01# | |
| | | | 12pF | ±5% | GRM0336T1E120JD01# | |

| T max. | Rated Voltage | TC Code | Cap. | Tol. | Part Number |
|--------|---------------|---------|-------|--------------------|--------------------|
| 0.33mm | 25Vdc | T2H | 15pF | ±5% | GRM0336T1E150JD01# |
| | | | 18pF | ±5% | GRM0336T1E180JD01# |
| | | | 22pF | ±5% | GRM0336T1E220JD01# |
| | | | 27pF | ±5% | GRM0336T1E270JD01# |
| | | | 33pF | ±5% | GRM0336T1E330JD01# |
| | | | 39pF | ±5% | GRM0336T1E390JD01# |
| | | | 47pF | ±5% | GRM0336T1E470JD01# |
| | | | 56pF | ±5% | GRM0336T1E560JD01# |
| | | | 68pF | ±5% | GRM0336T1E680JD01# |
| | | | 82pF | ±5% | GRM0336T1E820JD01# |
| | | 100pF | ±5% | GRM0336T1E101JD01# | |
| | | TK | 1.0pF | ±0.25pF | GRM0334T1E1R0CD01# |
| | | | 2.0pF | ±0.25pF | GRM0334T1E2R0CD01# |
| | | TJ | 3.0pF | ±0.25pF | GRM0333T1E3R0CD01# |
| | | TH | 4.0pF | ±0.25pF | GRM0332T1E4R0CD01# |
| | | | 5.0pF | ±0.25pF | GRM0332T1E5R0CD01# |
| | | | 6.0pF | ±0.5pF | GRM0332T1E6R0DD01# |
| | | | 7.0pF | ±0.5pF | GRM0332T1E7R0DD01# |
| | | | 8.0pF | ±0.5pF | GRM0332T1E8R0DD01# |
| | | | 9.0pF | ±0.5pF | GRM0332T1E9R0DD01# |
| | | | 10pF | ±5% | GRM0332T1E100JD01# |
| | | | 12pF | ±5% | GRM0332T1E120JD01# |
| | | | 15pF | ±5% | GRM0332T1E150JD01# |
| | | | 18pF | ±5% | GRM0332T1E180JD01# |
| | | | 22pF | ±5% | GRM0332T1E220JD01# |
| | | | 27pF | ±5% | GRM0332T1E270JD01# |
| | | | 33pF | ±5% | GRM0332T1E330JD01# |
| | | | 39pF | ±5% | GRM0332T1E390JD01# |
| | | | 47pF | ±5% | GRM0332T1E470JD01# |
| | | | 56pF | ±5% | GRM0332T1E560JD01# |
| | | | 68pF | ±5% | GRM0332T1E680JD01# |
| | | | 82pF | ±5% | GRM0332T1E820JD01# |
| | | 100pF | ±5% | GRM0332T1E101JD01# | |
| | | UJ | 18pF | ±5% | GRM0333U1E180JD01# |
| | | | 22pF | ±5% | GRM0333U1E220JD01# |
| | | | 27pF | ±5% | GRM0333U1E270JD01# |
| | | | 33pF | ±5% | GRM0333U1E330JD01# |
| | | | 39pF | ±5% | GRM0333U1E390JD01# |
| | | | 47pF | ±5% | GRM0333U1E470JD01# |
| | | | 56pF | ±5% | GRM0333U1E560JD01# |
| | | | 68pF | ±5% | GRM0333U1E680JD01# |
| | | | 82pF | ±5% | GRM0333U1E820JD01# |
| | | | 100pF | ±5% | GRM0333U1E101JD01# |

■ 1.0x0.5mm

| T max. | Rated Voltage | TC Code | Cap. | Tol. | Part Number |
|--------|---------------|---------|-------|--------|--------------------|
| 0.33mm | 50Vdc | C0G | 0.1pF | ±0.1pF | GRM1535C1HR10BDD5# |
| | | | 0.2pF | ±0.1pF | GRM1535C1HR20BDD5# |
| | | | 0.3pF | ±0.1pF | GRM1535C1HR30BDD5# |
| | | | 0.4pF | ±0.1pF | GRM1535C1HR40BDD5# |
| | | | 0.5pF | ±0.1pF | GRM1535C1HR50BDD5# |
| | | | 0.6pF | ±0.1pF | GRM1535C1HR60BDD5# |

Part number # indicates the package specification code.

For General Purpose GRM Series
 Capacitor Array GNM Series
 Low ESL LLI Series
 High-Q Type GJM Series
 High Frequency GQM Series
 Monolithic Microchip GMA Series
 For Bonding GMD Series
 Product Information

GRM Series Temperature Compensating Type Part Number List

(→ ■ 1.0x0.5mm)

| T max. | Rated Voltage | TC Code | Cap. | Tol. | Part Number |
|--------|---------------|--------------------|-------|---------|--------------------|
| 0.33mm | 50Vdc | C0G | 0.7pF | ±0.1pF | GRM1535C1HR70BDD5# |
| | | | 0.8pF | ±0.1pF | GRM1535C1HR80BDD5# |
| | | | 0.9pF | ±0.1pF | GRM1535C1HR90BDD5# |
| | | | 1.0pF | ±0.25pF | GRM1535C1H1R0CDD5# |
| | | | 1.1pF | ±0.25pF | GRM1535C1H1R1CDD5# |
| | | | 1.2pF | ±0.25pF | GRM1535C1H1R2CDD5# |
| | | | 1.3pF | ±0.25pF | GRM1535C1H1R3CDD5# |
| | | | 1.4pF | ±0.25pF | GRM1535C1H1R4CDD5# |
| | | | 1.5pF | ±0.25pF | GRM1535C1H1R5CDD5# |
| | | | 1.6pF | ±0.25pF | GRM1535C1H1R6CDD5# |
| | | | 1.7pF | ±0.25pF | GRM1535C1H1R7CDD5# |
| | | | 1.8pF | ±0.25pF | GRM1535C1H1R8CDD5# |
| | | | 1.9pF | ±0.25pF | GRM1535C1H1R9CDD5# |
| | | | 2.0pF | ±0.25pF | GRM1535C1H2R0CDD5# |
| | | | 2.1pF | ±0.25pF | GRM1535C1H2R1CDD5# |
| | | | 2.2pF | ±0.25pF | GRM1535C1H2R2CDD5# |
| | | | 2.3pF | ±0.25pF | GRM1535C1H2R3CDD5# |
| | | | 2.4pF | ±0.25pF | GRM1535C1H2R4CDD5# |
| | | | 2.5pF | ±0.25pF | GRM1535C1H2R5CDD5# |
| | | | 2.6pF | ±0.25pF | GRM1535C1H2R6CDD5# |
| | | | 2.7pF | ±0.25pF | GRM1535C1H2R7CDD5# |
| | | | 2.8pF | ±0.25pF | GRM1535C1H2R8CDD5# |
| | | | 2.9pF | ±0.25pF | GRM1535C1H2R9CDD5# |
| | | | 3.0pF | ±0.25pF | GRM1535C1H3R0CDD5# |
| | | | 3.1pF | ±0.25pF | GRM1535C1H3R1CDD5# |
| | | | 3.2pF | ±0.25pF | GRM1535C1H3R2CDD5# |
| | | | 3.3pF | ±0.25pF | GRM1535C1H3R3CDD5# |
| | | | 3.4pF | ±0.25pF | GRM1535C1H3R4CDD5# |
| | | | 3.5pF | ±0.25pF | GRM1535C1H3R5CDD5# |
| | | | 3.6pF | ±0.25pF | GRM1535C1H3R6CDD5# |
| 3.7pF | ±0.25pF | GRM1535C1H3R7CDD5# | | | |
| 3.8pF | ±0.25pF | GRM1535C1H3R8CDD5# | | | |
| 3.9pF | ±0.25pF | GRM1535C1H3R9CDD5# | | | |
| 4.0pF | ±0.25pF | GRM1535C1H4R0CDD5# | | | |
| 4.1pF | ±0.25pF | GRM1535C1H4R1CDD5# | | | |
| 4.2pF | ±0.25pF | GRM1535C1H4R2CDD5# | | | |
| 4.3pF | ±0.25pF | GRM1535C1H4R3CDD5# | | | |
| 4.4pF | ±0.25pF | GRM1535C1H4R4CDD5# | | | |
| 4.5pF | ±0.25pF | GRM1535C1H4R5CDD5# | | | |
| 4.6pF | ±0.25pF | GRM1535C1H4R6CDD5# | | | |
| 4.7pF | ±0.25pF | GRM1535C1H4R7CDD5# | | | |
| 4.8pF | ±0.25pF | GRM1535C1H4R8CDD5# | | | |
| 4.9pF | ±0.25pF | GRM1535C1H4R9CDD5# | | | |
| 5.0pF | ±0.25pF | GRM1535C1H5R0CDD5# | | | |
| 5.1pF | ±0.5pF | GRM1535C1H5R1DDD5# | | | |
| 5.2pF | ±0.5pF | GRM1535C1H5R2DDD5# | | | |
| 5.3pF | ±0.5pF | GRM1535C1H5R3DDD5# | | | |
| 5.4pF | ±0.5pF | GRM1535C1H5R4DDD5# | | | |
| 5.5pF | ±0.5pF | GRM1535C1H5R5DDD5# | | | |
| 5.6pF | ±0.5pF | GRM1535C1H5R6DDD5# | | | |
| 5.7pF | ±0.5pF | GRM1535C1H5R7DDD5# | | | |
| 5.8pF | ±0.5pF | GRM1535C1H5R8DDD5# | | | |
| 5.9pF | ±0.5pF | GRM1535C1H5R9DDD5# | | | |
| 6.0pF | ±0.5pF | GRM1535C1H6R0DDD5# | | | |

| T max. | Rated Voltage | TC Code | Cap. | Tol. | Part Number |
|--------|---------------|--------------------|-------|--------|--------------------|
| 0.33mm | 50Vdc | C0G | 6.1pF | ±0.5pF | GRM1535C1H6R1DDD5# |
| | | | 6.2pF | ±0.5pF | GRM1535C1H6R2DDD5# |
| | | | 6.3pF | ±0.5pF | GRM1535C1H6R3DDD5# |
| | | | 6.4pF | ±0.5pF | GRM1535C1H6R4DDD5# |
| | | | 6.5pF | ±0.5pF | GRM1535C1H6R5DDD5# |
| | | | 6.6pF | ±0.5pF | GRM1535C1H6R6DDD5# |
| | | | 6.7pF | ±0.5pF | GRM1535C1H6R7DDD5# |
| | | | 6.8pF | ±0.5pF | GRM1535C1H6R8DDD5# |
| | | | 6.9pF | ±0.5pF | GRM1535C1H6R9DDD5# |
| | | | 7.0pF | ±0.5pF | GRM1535C1H7R0DDD5# |
| | | | 7.1pF | ±0.5pF | GRM1535C1H7R1DDD5# |
| | | | 7.2pF | ±0.5pF | GRM1535C1H7R2DDD5# |
| | | | 7.3pF | ±0.5pF | GRM1535C1H7R3DDD5# |
| | | | 7.4pF | ±0.5pF | GRM1535C1H7R4DDD5# |
| | | | 7.5pF | ±0.5pF | GRM1535C1H7R5DDD5# |
| | | | 7.6pF | ±0.5pF | GRM1535C1H7R6DDD5# |
| | | | 7.7pF | ±0.5pF | GRM1535C1H7R7DDD5# |
| | | | 7.8pF | ±0.5pF | GRM1535C1H7R8DDD5# |
| | | | 7.9pF | ±0.5pF | GRM1535C1H7R9DDD5# |
| | | | 8.0pF | ±0.5pF | GRM1535C1H8R0DDD5# |
| | | | 8.1pF | ±0.5pF | GRM1535C1H8R1DDD5# |
| | | | 8.2pF | ±0.5pF | GRM1535C1H8R2DDD5# |
| | | | 8.3pF | ±0.5pF | GRM1535C1H8R3DDD5# |
| | | | 8.4pF | ±0.5pF | GRM1535C1H8R4DDD5# |
| | | | 8.5pF | ±0.5pF | GRM1535C1H8R5DDD5# |
| | | | 8.6pF | ±0.5pF | GRM1535C1H8R6DDD5# |
| | | | 8.7pF | ±0.5pF | GRM1535C1H8R7DDD5# |
| | | | 8.8pF | ±0.5pF | GRM1535C1H8R8DDD5# |
| | | | 8.9pF | ±0.5pF | GRM1535C1H8R9DDD5# |
| | | | 9.0pF | ±0.5pF | GRM1535C1H9R0DDD5# |
| 9.1pF | ±0.5pF | GRM1535C1H9R1DDD5# | | | |
| 9.2pF | ±0.5pF | GRM1535C1H9R2DDD5# | | | |
| 9.3pF | ±0.5pF | GRM1535C1H9R3DDD5# | | | |
| 9.4pF | ±0.5pF | GRM1535C1H9R4DDD5# | | | |
| 9.5pF | ±0.5pF | GRM1535C1H9R5DDD5# | | | |
| 9.6pF | ±0.5pF | GRM1535C1H9R6DDD5# | | | |
| 9.7pF | ±0.5pF | GRM1535C1H9R7DDD5# | | | |
| 9.8pF | ±0.5pF | GRM1535C1H9R8DDD5# | | | |
| 9.9pF | ±0.5pF | GRM1535C1H9R9DDD5# | | | |
| 10pF | ±5% | GRM1535C1H100JDD5# | | | |
| 12pF | ±5% | GRM1535C1H120JDD5# | | | |
| 15pF | ±5% | GRM1535C1H150JDD5# | | | |
| 18pF | ±5% | GRM1535C1H180JDD5# | | | |
| 22pF | ±5% | GRM1535C1H220JDD5# | | | |
| 27pF | ±5% | GRM1535C1H270JDD5# | | | |
| 33pF | ±5% | GRM1535C1H330JDD5# | | | |
| 39pF | ±5% | GRM1535C1H390JDD5# | | | |
| 47pF | ±5% | GRM1535C1H470JDD5# | | | |
| 56pF | ±5% | GRM1535C1H560JDD5# | | | |
| 68pF | ±5% | GRM1535C1H680JDD5# | | | |
| 82pF | ±5% | GRM1535C1H820JDD5# | | | |
| 100pF | ±5% | GRM1535C1H101JDD5# | | | |
| 120pF | ±5% | GRM1535C1H121JDD5# | | | |
| 150pF | ±5% | GRM1535C1H151JDD5# | | | |

Part number # indicates the package specification code.

GRM Series Temperature Compensating Type Part Number List

(→ ■ 1.0x0.5mm)

| T max. | Rated Voltage | TC Code | Cap. | Tol. | Part Number | |
|--------|---------------|---------|--------------------|---------|--------------------|--------------------|
| 0.33mm | 50Vdc | COG | 180pF | ±5% | GRM1535C1H181JDD5# | |
| | | | 220pF | ±5% | GRM1535C1H221JDD5# | |
| | | | 270pF | ±5% | GRM1535C1H271JDD5# | |
| | | | 330pF | ±5% | GRM1535C1H331JDD5# | |
| | | | 390pF | ±5% | GRM1535C1H391JDD5# | |
| | | | 470pF | ±5% | GRM1535C1H471JDD5# | |
| | | | 560pF | ±5% | GRM1535C1H561JDD5# | |
| | | | 680pF | ±5% | GRM1535C1H681JDD5# | |
| | | CK | 0.1pF | ±0.1pF | GRM1534C1HR10BDD5# | |
| | | | 0.2pF | ±0.1pF | GRM1534C1HR20BDD5# | |
| | | | 0.3pF | ±0.1pF | GRM1534C1HR30BDD5# | |
| | | | 0.4pF | ±0.1pF | GRM1534C1HR40BDD5# | |
| | | | 0.5pF | ±0.1pF | GRM1534C1HR50BDD5# | |
| | | | 0.6pF | ±0.1pF | GRM1534C1HR60BDD5# | |
| | | | 0.7pF | ±0.1pF | GRM1534C1HR70BDD5# | |
| | | | 0.8pF | ±0.1pF | GRM1534C1HR80BDD5# | |
| | | | 0.9pF | ±0.1pF | GRM1534C1HR90BDD5# | |
| | | | 1.0pF | ±0.25pF | GRM1534C1H1R0CDD5# | |
| | | | 1.1pF | ±0.25pF | GRM1534C1H1R1CDD5# | |
| | | | 1.2pF | ±0.25pF | GRM1534C1H1R2CDD5# | |
| | | | 1.3pF | ±0.25pF | GRM1534C1H1R3CDD5# | |
| | | | 1.4pF | ±0.25pF | GRM1534C1H1R4CDD5# | |
| | | | 1.5pF | ±0.25pF | GRM1534C1H1R5CDD5# | |
| | | | 1.6pF | ±0.25pF | GRM1534C1H1R6CDD5# | |
| | | | 1.7pF | ±0.25pF | GRM1534C1H1R7CDD5# | |
| | | | 1.8pF | ±0.25pF | GRM1534C1H1R8CDD5# | |
| | | | 1.9pF | ±0.25pF | GRM1534C1H1R9CDD5# | |
| | | | 2.0pF | ±0.25pF | GRM1534C1H2R0CDD5# | |
| | | | CJ | 2.1pF | ±0.25pF | GRM1533C1H2R1CDD5# |
| | | | | 2.2pF | ±0.25pF | GRM1533C1H2R2CDD5# |
| | | | | 2.3pF | ±0.25pF | GRM1533C1H2R3CDD5# |
| | | | | 2.4pF | ±0.25pF | GRM1533C1H2R4CDD5# |
| | | | | 2.5pF | ±0.25pF | GRM1533C1H2R5CDD5# |
| | | | | 2.6pF | ±0.25pF | GRM1533C1H2R6CDD5# |
| | | | | 2.7pF | ±0.25pF | GRM1533C1H2R7CDD5# |
| | | | | 2.8pF | ±0.25pF | GRM1533C1H2R8CDD5# |
| | | | | 2.9pF | ±0.25pF | GRM1533C1H2R9CDD5# |
| | | | | 3.0pF | ±0.25pF | GRM1533C1H3R0CDD5# |
| | | | | 3.1pF | ±0.25pF | GRM1533C1H3R1CDD5# |
| | | | | 3.2pF | ±0.25pF | GRM1533C1H3R2CDD5# |
| | | CH | 3.3pF | ±0.25pF | GRM1533C1H3R3CDD5# | |
| | | | 3.4pF | ±0.25pF | GRM1533C1H3R4CDD5# | |
| | | | 3.5pF | ±0.25pF | GRM1533C1H3R5CDD5# | |
| | | | 3.6pF | ±0.25pF | GRM1533C1H3R6CDD5# | |
| | | | 3.7pF | ±0.25pF | GRM1533C1H3R7CDD5# | |
| | | | 3.8pF | ±0.25pF | GRM1533C1H3R8CDD5# | |
| 3.9pF | ±0.25pF | | GRM1533C1H3R9CDD5# | | | |
| 4.0pF | ±0.25pF | | GRM1532C1H4R0CDD5# | | | |
| 4.1pF | ±0.25pF | | GRM1532C1H4R1CDD5# | | | |
| 4.2pF | ±0.25pF | | GRM1532C1H4R2CDD5# | | | |
| 4.3pF | ±0.25pF | | GRM1532C1H4R3CDD5# | | | |
| 4.4pF | ±0.25pF | | GRM1532C1H4R4CDD5# | | | |
| 4.5pF | ±0.25pF | | GRM1532C1H4R5CDD5# | | | |
| 4.6pF | ±0.25pF | | GRM1532C1H4R6CDD5# | | | |

| T max. | Rated Voltage | TC Code | Cap. | Tol. | Part Number |
|--------|---------------|--------------------|-------|---------|--------------------|
| 0.33mm | 50Vdc | CH | 4.7pF | ±0.25pF | GRM1532C1H4R7CDD5# |
| | | | 4.8pF | ±0.25pF | GRM1532C1H4R8CDD5# |
| | | | 4.9pF | ±0.25pF | GRM1532C1H4R9CDD5# |
| | | | 5.0pF | ±0.25pF | GRM1532C1H5R0CDD5# |
| | | | 5.1pF | ±0.5pF | GRM1532C1H5R1DDD5# |
| | | | 5.2pF | ±0.5pF | GRM1532C1H5R2DDD5# |
| | | | 5.3pF | ±0.5pF | GRM1532C1H5R3DDD5# |
| | | | 5.4pF | ±0.5pF | GRM1532C1H5R4DDD5# |
| | | | 5.5pF | ±0.5pF | GRM1532C1H5R5DDD5# |
| | | | 5.6pF | ±0.5pF | GRM1532C1H5R6DDD5# |
| | | | 5.7pF | ±0.5pF | GRM1532C1H5R7DDD5# |
| | | | 5.8pF | ±0.5pF | GRM1532C1H5R8DDD5# |
| | | | 5.9pF | ±0.5pF | GRM1532C1H5R9DDD5# |
| | | | 6.0pF | ±0.5pF | GRM1532C1H6R0DDD5# |
| | | | 6.1pF | ±0.5pF | GRM1532C1H6R1DDD5# |
| | | | 6.2pF | ±0.5pF | GRM1532C1H6R2DDD5# |
| | | | 6.3pF | ±0.5pF | GRM1532C1H6R3DDD5# |
| | | | 6.4pF | ±0.5pF | GRM1532C1H6R4DDD5# |
| | | | 6.5pF | ±0.5pF | GRM1532C1H6R5DDD5# |
| | | | 6.6pF | ±0.5pF | GRM1532C1H6R6DDD5# |
| | | | 6.7pF | ±0.5pF | GRM1532C1H6R7DDD5# |
| | | | 6.8pF | ±0.5pF | GRM1532C1H6R8DDD5# |
| | | | 6.9pF | ±0.5pF | GRM1532C1H6R9DDD5# |
| | | | 7.0pF | ±0.5pF | GRM1532C1H7R0DDD5# |
| | | | 7.1pF | ±0.5pF | GRM1532C1H7R1DDD5# |
| | | | 7.2pF | ±0.5pF | GRM1532C1H7R2DDD5# |
| | | | 7.3pF | ±0.5pF | GRM1532C1H7R3DDD5# |
| | | | 7.4pF | ±0.5pF | GRM1532C1H7R4DDD5# |
| | | | 7.5pF | ±0.5pF | GRM1532C1H7R5DDD5# |
| | | | 7.6pF | ±0.5pF | GRM1532C1H7R6DDD5# |
| 7.7pF | ±0.5pF | GRM1532C1H7R7DDD5# | | | |
| 7.8pF | ±0.5pF | GRM1532C1H7R8DDD5# | | | |
| 7.9pF | ±0.5pF | GRM1532C1H7R9DDD5# | | | |
| 8.0pF | ±0.5pF | GRM1532C1H8R0DDD5# | | | |
| 8.1pF | ±0.5pF | GRM1532C1H8R1DDD5# | | | |
| 8.2pF | ±0.5pF | GRM1532C1H8R2DDD5# | | | |
| 8.3pF | ±0.5pF | GRM1532C1H8R3DDD5# | | | |
| 8.4pF | ±0.5pF | GRM1532C1H8R4DDD5# | | | |
| 8.5pF | ±0.5pF | GRM1532C1H8R5DDD5# | | | |
| 8.6pF | ±0.5pF | GRM1532C1H8R6DDD5# | | | |
| 8.7pF | ±0.5pF | GRM1532C1H8R7DDD5# | | | |
| 8.8pF | ±0.5pF | GRM1532C1H8R8DDD5# | | | |
| 8.9pF | ±0.5pF | GRM1532C1H8R9DDD5# | | | |
| 9.0pF | ±0.5pF | GRM1532C1H9R0DDD5# | | | |
| 9.1pF | ±0.5pF | GRM1532C1H9R1DDD5# | | | |
| 9.2pF | ±0.5pF | GRM1532C1H9R2DDD5# | | | |
| 9.3pF | ±0.5pF | GRM1532C1H9R3DDD5# | | | |
| 9.4pF | ±0.5pF | GRM1532C1H9R4DDD5# | | | |
| 9.5pF | ±0.5pF | GRM1532C1H9R5DDD5# | | | |
| 9.6pF | ±0.5pF | GRM1532C1H9R6DDD5# | | | |
| 9.7pF | ±0.5pF | GRM1532C1H9R7DDD5# | | | |
| 9.8pF | ±0.5pF | GRM1532C1H9R8DDD5# | | | |
| 9.9pF | ±0.5pF | GRM1532C1H9R9DDD5# | | | |
| 10pF | ±5% | GRM1532C1H100JDD5# | | | |

Part number # indicates the package specification code.

For General Purpose GRM Series
 Capacitor Array GNM Series
 Low ESL LLI Series
 High-Q Type GJM Series
 High Frequency GQM Series
 Monolithic Microchip GMA Series
 For Bonding GMD Series
 Product Information

GRM Series Temperature Compensating Type Part Number List

(→ ■ 1.0x0.5mm)

| T max. | Rated Voltage | TC Code | Cap. | Tol. | Part Number |
|--------|---------------|--------------------|-------|---------|--------------------|
| 0.33mm | 50Vdc | CH | 12pF | ±5% | GRM1532C1H120JDD5# |
| | | | 15pF | ±5% | GRM1532C1H150JDD5# |
| | | | 18pF | ±5% | GRM1532C1H180JDD5# |
| | | | 22pF | ±5% | GRM1532C1H220JDD5# |
| | | | 27pF | ±5% | GRM1532C1H270JDD5# |
| | | | 33pF | ±5% | GRM1532C1H330JDD5# |
| | | | 39pF | ±5% | GRM1532C1H390JDD5# |
| | | | 47pF | ±5% | GRM1532C1H470JDD5# |
| | | | 56pF | ±5% | GRM1532C1H560JDD5# |
| | | | 68pF | ±5% | GRM1532C1H680JDD5# |
| | | | 82pF | ±5% | GRM1532C1H820JDD5# |
| | | | 100pF | ±5% | GRM1532C1H101JDD5# |
| | | | 120pF | ±5% | GRM1532C1H121JDD5# |
| | | | 150pF | ±5% | GRM1532C1H151JDD5# |
| | | | 180pF | ±5% | GRM1532C1H181JDD5# |
| | | | 220pF | ±5% | GRM1532C1H221JDD5# |
| | | | 270pF | ±5% | GRM1532C1H271JDD5# |
| | | | 330pF | ±5% | GRM1532C1H331JDD5# |
| | | | 390pF | ±5% | GRM1532C1H391JDD5# |
| | | | 470pF | ±5% | GRM1532C1H471JDD5# |
| 560pF | ±5% | GRM1532C1H561JDD5# | | | |
| 680pF | ±5% | GRM1532C1H681JDD5# | | | |
| 0.55mm | 50Vdc | C0G | 0.1pF | ±0.05pF | GRM1555C1HR10WA01# |
| | | | | ±0.1pF | GRM1555C1HR10BA01# |
| | | | 0.2pF | ±0.05pF | GRM1555C1HR20WA01# |
| | | | | ±0.1pF | GRM1555C1HR20BA01# |
| | | | 0.3pF | ±0.05pF | GRM1555C1HR30WA01# |
| | | | | ±0.1pF | GRM1555C1HR30BA01# |
| | | | 0.4pF | ±0.05pF | GRM1555C1HR40WA01# |
| | | | | ±0.1pF | GRM1555C1HR40BA01# |
| | | | 0.5pF | ±0.05pF | GRM1555C1HR50WA01# |
| | | | | ±0.1pF | GRM1555C1HR50BA01# |
| | | | 0.6pF | ±0.05pF | GRM1555C1HR60WA01# |
| | | | | ±0.1pF | GRM1555C1HR60BA01# |
| | | | 0.7pF | ±0.05pF | GRM1555C1HR70WA01# |
| | | | | ±0.1pF | GRM1555C1HR70BA01# |
| | | | 0.8pF | ±0.05pF | GRM1555C1HR80WA01# |
| | | | | ±0.1pF | GRM1555C1HR80BA01# |
| | | | 0.9pF | ±0.05pF | GRM1555C1HR90WA01# |
| | | | | ±0.1pF | GRM1555C1HR90BA01# |
| | | | 1.0pF | ±0.05pF | GRM1555C1H1R0WA01# |
| | | | | ±0.1pF | GRM1555C1H1R0BA01# |
| | | | | ±0.25pF | GRM1555C1H1R0CA01# |
| | | | 1.1pF | ±0.05pF | GRM1555C1H1R1WA01# |
| | | | | ±0.1pF | GRM1555C1H1R1BA01# |
| | | | | ±0.25pF | GRM1555C1H1R1CA01# |
| | | | 1.2pF | ±0.05pF | GRM1555C1H1R2WA01# |
| | | | | ±0.1pF | GRM1555C1H1R2BA01# |
| | | | | ±0.25pF | GRM1555C1H1R2CA01# |
| | | | 1.3pF | ±0.05pF | GRM1555C1H1R3WA01# |
| | | | | ±0.1pF | GRM1555C1H1R3BA01# |
| | | | | ±0.25pF | GRM1555C1H1R3CA01# |
| | | | 1.4pF | ±0.05pF | GRM1555C1H1R4WA01# |
| | | | | ±0.1pF | GRM1555C1H1R4BA01# |

| T max. | Rated Voltage | TC Code | Cap. | Tol. | Part Number |
|--------|---------------|--------------------|-------|---------|--------------------|
| 0.55mm | 50Vdc | C0G | 1.4pF | ±0.25pF | GRM1555C1H1R4CA01# |
| | | | | ±0.05pF | GRM1555C1H1R5WA01# |
| | | | | ±0.1pF | GRM1555C1H1R5BA01# |
| | | | 1.5pF | ±0.25pF | GRM1555C1H1R5CA01# |
| | | | | ±0.05pF | GRM1555C1H1R6WA01# |
| | | | | ±0.1pF | GRM1555C1H1R6BA01# |
| | | | 1.6pF | ±0.25pF | GRM1555C1H1R6CA01# |
| | | | | ±0.05pF | GRM1555C1H1R7WA01# |
| | | | | ±0.1pF | GRM1555C1H1R7BA01# |
| | | | 1.7pF | ±0.25pF | GRM1555C1H1R7CA01# |
| | | | | ±0.05pF | GRM1555C1H1R8WA01# |
| | | | | ±0.1pF | GRM1555C1H1R8BA01# |
| | | | 1.8pF | ±0.25pF | GRM1555C1H1R8CA01# |
| | | | | ±0.05pF | GRM1555C1H1R9WA01# |
| | | | | ±0.1pF | GRM1555C1H1R9BA01# |
| | | | 1.9pF | ±0.25pF | GRM1555C1H1R9CA01# |
| | | | | ±0.05pF | GRM1555C1H2R0WA01# |
| | | | | ±0.1pF | GRM1555C1H2R0BA01# |
| | | | 2.0pF | ±0.25pF | GRM1555C1H2R0CA01# |
| | | | | ±0.05pF | GRM1555C1H2R1WA01# |
| | | | | ±0.1pF | GRM1555C1H2R1BA01# |
| | | | 2.1pF | ±0.25pF | GRM1555C1H2R1CA01# |
| | | | | ±0.05pF | GRM1555C1H2R2WA01# |
| | | | | ±0.1pF | GRM1555C1H2R2BA01# |
| | | | 2.2pF | ±0.25pF | GRM1555C1H2R2CA01# |
| | | | | ±0.05pF | GRM1555C1H2R3WA01# |
| | | | | ±0.1pF | GRM1555C1H2R3BA01# |
| | | | 2.3pF | ±0.25pF | GRM1555C1H2R3CA01# |
| | | | | ±0.05pF | GRM1555C1H2R4WA01# |
| | | | | ±0.1pF | GRM1555C1H2R4BA01# |
| | | | 2.4pF | ±0.25pF | GRM1555C1H2R4CA01# |
| | | | | ±0.05pF | GRM1555C1H2R5WA01# |
| | | | | ±0.1pF | GRM1555C1H2R5BA01# |
| | | | 2.5pF | ±0.25pF | GRM1555C1H2R5CA01# |
| | | | | ±0.05pF | GRM1555C1H2R6WA01# |
| | | | | ±0.1pF | GRM1555C1H2R6BA01# |
| | | | 2.6pF | ±0.25pF | GRM1555C1H2R6CA01# |
| | | | | ±0.05pF | GRM1555C1H2R7WA01# |
| | | | | ±0.1pF | GRM1555C1H2R7BA01# |
| | | | 2.7pF | ±0.25pF | GRM1555C1H2R7CA01# |
| | | | | ±0.05pF | GRM1555C1H2R8WA01# |
| | | | | ±0.1pF | GRM1555C1H2R8BA01# |
| | | | 2.8pF | ±0.25pF | GRM1555C1H2R8CA01# |
| | | | | ±0.05pF | GRM1555C1H2R9WA01# |
| | | | | ±0.1pF | GRM1555C1H2R9BA01# |
| | | | 2.9pF | ±0.25pF | GRM1555C1H2R9CA01# |
| | | | | ±0.05pF | GRM1555C1H3R0WA01# |
| | | | | ±0.1pF | GRM1555C1H3R0BA01# |
| 3.0pF | ±0.25pF | GRM1555C1H3R0CA01# | | | |
| | ±0.05pF | GRM1555C1H3R1WA01# | | | |
| | ±0.1pF | GRM1555C1H3R1BA01# | | | |
| 3.1pF | ±0.25pF | GRM1555C1H3R1CA01# | | | |
| | ±0.05pF | GRM1555C1H3R2WA01# | | | |
| | ±0.1pF | GRM1555C1H3R2BA01# | | | |

For General Purpose GRM Series
 Capacitor Array GNM Series
 Low ESL LL□ Series
 High-Q Type GJM Series
 High Frequency GQM Series
 Monolithic Microchip GMA Series
 For Bonding GMD Series
 Product Information

Part number # indicates the package specification code.

GRM Series Temperature Compensating Type Part Number List

(→ ■ 1.0x0.5mm)

| T max. | Rated Voltage | TC Code | Cap. | Tol. | Part Number |
|--------|---------------|---------|---------|---------|--------------------|
| 0.55mm | 50Vdc | C0G | 3.2pF | ±0.25pF | GRM1555C1H3R2CA01# |
| | | | | ±0.05pF | GRM1555C1H3R3WA01# |
| | | | | | ±0.1pF |
| | | | ±0.25pF | | GRM1555C1H3R3CA01# |
| | | | 3.4pF | ±0.05pF | GRM1555C1H3R4WA01# |
| | | | | ±0.1pF | GRM1555C1H3R4BA01# |
| | | | | ±0.25pF | GRM1555C1H3R4CA01# |
| | | | 3.5pF | ±0.05pF | GRM1555C1H3R5WA01# |
| | | | | ±0.1pF | GRM1555C1H3R5BA01# |
| | | | | ±0.25pF | GRM1555C1H3R5CA01# |
| | | | 3.6pF | ±0.05pF | GRM1555C1H3R6WA01# |
| | | | | ±0.1pF | GRM1555C1H3R6BA01# |
| | | | | ±0.25pF | GRM1555C1H3R6CA01# |
| | | | 3.7pF | ±0.05pF | GRM1555C1H3R7WA01# |
| | | | | ±0.1pF | GRM1555C1H3R7BA01# |
| | | | | ±0.25pF | GRM1555C1H3R7CA01# |
| | | | 3.8pF | ±0.05pF | GRM1555C1H3R8WA01# |
| | | | | ±0.1pF | GRM1555C1H3R8BA01# |
| | | | | ±0.25pF | GRM1555C1H3R8CA01# |
| | | | 3.9pF | ±0.05pF | GRM1555C1H3R9WA01# |
| | | | | ±0.1pF | GRM1555C1H3R9BA01# |
| | | | | ±0.25pF | GRM1555C1H3R9CA01# |
| | | | 4.0pF | ±0.05pF | GRM1555C1H4R0WA01# |
| | | | | ±0.1pF | GRM1555C1H4R0BA01# |
| | | | | ±0.25pF | GRM1555C1H4R0CA01# |
| | | | 4.1pF | ±0.05pF | GRM1555C1H4R1WA01# |
| | | | | ±0.1pF | GRM1555C1H4R1BA01# |
| | | | | ±0.25pF | GRM1555C1H4R1CA01# |
| | | | 4.2pF | ±0.05pF | GRM1555C1H4R2WA01# |
| | | | | ±0.1pF | GRM1555C1H4R2BA01# |
| | | | | ±0.25pF | GRM1555C1H4R2CA01# |
| | | | 4.3pF | ±0.05pF | GRM1555C1H4R3WA01# |
| | | | | ±0.1pF | GRM1555C1H4R3BA01# |
| | | | | ±0.25pF | GRM1555C1H4R3CA01# |
| | | | 4.4pF | ±0.05pF | GRM1555C1H4R4WA01# |
| | | | | ±0.1pF | GRM1555C1H4R4BA01# |
| | | | | ±0.25pF | GRM1555C1H4R4CA01# |
| | | | 4.5pF | ±0.05pF | GRM1555C1H4R5WA01# |
| | | | | ±0.1pF | GRM1555C1H4R5BA01# |
| | | | | ±0.25pF | GRM1555C1H4R5CA01# |
| | | | 4.6pF | ±0.05pF | GRM1555C1H4R6WA01# |
| | | | | ±0.1pF | GRM1555C1H4R6BA01# |
| | | | | ±0.25pF | GRM1555C1H4R6CA01# |
| | | | 4.7pF | ±0.05pF | GRM1555C1H4R7WA01# |
| | | | | ±0.1pF | GRM1555C1H4R7BA01# |
| | | | | ±0.25pF | GRM1555C1H4R7CA01# |
| | | | 4.8pF | ±0.05pF | GRM1555C1H4R8WA01# |
| | | | | ±0.1pF | GRM1555C1H4R8BA01# |
| | | | | ±0.25pF | GRM1555C1H4R8CA01# |
| | | | 4.9pF | ±0.05pF | GRM1555C1H4R9WA01# |
| | | | | ±0.1pF | GRM1555C1H4R9BA01# |
| | | | | ±0.25pF | GRM1555C1H4R9CA01# |
| | | | 5.0pF | ±0.05pF | GRM1555C1H5R0WA01# |
| | | | | ±0.1pF | GRM1555C1H5R0BA01# |

| T max. | Rated Voltage | TC Code | Cap. | Tol. | Part Number |
|--------|---------------|---------|---------|---------|--------------------|
| 0.55mm | 50Vdc | C0G | 5.0pF | ±0.25pF | GRM1555C1H5R0CA01# |
| | | | | ±0.05pF | GRM1555C1H5R1WA01# |
| | | | | | ±0.1pF |
| | | | ±0.25pF | | GRM1555C1H5R1CA01# |
| | | | 5.1pF | ±0.05pF | GRM1555C1H5R2WA01# |
| | | | | ±0.1pF | GRM1555C1H5R2BA01# |
| | | | | ±0.25pF | GRM1555C1H5R2CA01# |
| | | | 5.2pF | ±0.05pF | GRM1555C1H5R3WA01# |
| | | | | ±0.1pF | GRM1555C1H5R3BA01# |
| | | | | ±0.25pF | GRM1555C1H5R3CA01# |
| | | | 5.3pF | ±0.05pF | GRM1555C1H5R4WA01# |
| | | | | ±0.1pF | GRM1555C1H5R4BA01# |
| | | | | ±0.25pF | GRM1555C1H5R4CA01# |
| | | | 5.4pF | ±0.05pF | GRM1555C1H5R5WA01# |
| | | | | ±0.1pF | GRM1555C1H5R5BA01# |
| | | | | ±0.25pF | GRM1555C1H5R5CA01# |
| | | | 5.5pF | ±0.05pF | GRM1555C1H5R6WA01# |
| | | | | ±0.1pF | GRM1555C1H5R6BA01# |
| | | | | ±0.25pF | GRM1555C1H5R6CA01# |
| | | | 5.6pF | ±0.05pF | GRM1555C1H5R7WA01# |
| | | | | ±0.1pF | GRM1555C1H5R7BA01# |
| | | | | ±0.25pF | GRM1555C1H5R7CA01# |
| | | | 5.7pF | ±0.05pF | GRM1555C1H5R8WA01# |
| | | | | ±0.1pF | GRM1555C1H5R8BA01# |
| | | | | ±0.25pF | GRM1555C1H5R8CA01# |
| | | | 5.8pF | ±0.05pF | GRM1555C1H5R9WA01# |
| | | | | ±0.1pF | GRM1555C1H5R9BA01# |
| | | | | ±0.25pF | GRM1555C1H5R9CA01# |
| | | | 5.9pF | ±0.05pF | GRM1555C1H6R0WA01# |
| | | | | ±0.1pF | GRM1555C1H6R0BA01# |
| | | | | ±0.25pF | GRM1555C1H6R0CA01# |
| | | | 6.0pF | ±0.05pF | GRM1555C1H6R1WA01# |
| | | | | ±0.1pF | GRM1555C1H6R1BA01# |
| | | | | ±0.25pF | GRM1555C1H6R1CA01# |
| | | | 6.1pF | ±0.05pF | GRM1555C1H6R2WA01# |
| | | | | ±0.1pF | GRM1555C1H6R2BA01# |
| | | | | ±0.25pF | GRM1555C1H6R2CA01# |
| | | | 6.2pF | ±0.05pF | GRM1555C1H6R3WA01# |
| | | | | ±0.1pF | GRM1555C1H6R3BA01# |
| | | | | ±0.25pF | GRM1555C1H6R3CA01# |
| | | | 6.3pF | ±0.05pF | GRM1555C1H6R4WA01# |
| | | | | ±0.1pF | GRM1555C1H6R4BA01# |
| | | | | ±0.25pF | GRM1555C1H6R4CA01# |

Part number # indicates the package specification code.

For General Purpose GRM Series

Capacitor Array GNM Series

Low ESL LLI Series

High-Q Type GJM Series

High Frequency GQM Series

Monolithic Microchip GMA Series

For Bonding GMD Series

Product Information

GRM Series Temperature Compensating Type Part Number List

(→ ■ 1.0x0.5mm)

| T max. | Rated Voltage | TC Code | Cap. | Tol. | Part Number |
|--------|---------------|---------|-------|---------|--------------------|
| 0.55mm | 50Vdc | C0G | 6.4pF | ±0.1pF | GRM1555C1H6R4BA01# |
| | | | | ±0.25pF | GRM1555C1H6R4CA01# |
| | | | | ±0.5pF | GRM1555C1H6R4DA01# |
| | | | 6.5pF | ±0.05pF | GRM1555C1H6R5WA01# |
| | | | | ±0.1pF | GRM1555C1H6R5BA01# |
| | | | | ±0.25pF | GRM1555C1H6R5CA01# |
| | | | 6.6pF | ±0.05pF | GRM1555C1H6R6WA01# |
| | | | | ±0.1pF | GRM1555C1H6R6BA01# |
| | | | | ±0.25pF | GRM1555C1H6R6CA01# |
| | | | 6.7pF | ±0.05pF | GRM1555C1H6R7WA01# |
| | | | | ±0.1pF | GRM1555C1H6R7BA01# |
| | | | | ±0.25pF | GRM1555C1H6R7CA01# |
| | | | 6.8pF | ±0.05pF | GRM1555C1H6R8WA01# |
| | | | | ±0.1pF | GRM1555C1H6R8BA01# |
| | | | | ±0.25pF | GRM1555C1H6R8CA01# |
| | | | 6.9pF | ±0.05pF | GRM1555C1H6R9WA01# |
| | | | | ±0.1pF | GRM1555C1H6R9BA01# |
| | | | | ±0.25pF | GRM1555C1H6R9CA01# |
| | | | 7.0pF | ±0.05pF | GRM1555C1H7R0WA01# |
| | | | | ±0.1pF | GRM1555C1H7R0BA01# |
| | | | | ±0.25pF | GRM1555C1H7R0CA01# |
| | | | 7.1pF | ±0.05pF | GRM1555C1H7R1WA01# |
| | | | | ±0.1pF | GRM1555C1H7R1BA01# |
| | | | | ±0.25pF | GRM1555C1H7R1CA01# |
| | | | 7.2pF | ±0.05pF | GRM1555C1H7R2WA01# |
| | | | | ±0.1pF | GRM1555C1H7R2BA01# |
| | | | | ±0.25pF | GRM1555C1H7R2CA01# |
| | | | 7.3pF | ±0.05pF | GRM1555C1H7R3WA01# |
| | | | | ±0.1pF | GRM1555C1H7R3BA01# |
| | | | | ±0.25pF | GRM1555C1H7R3CA01# |
| | | | 7.4pF | ±0.05pF | GRM1555C1H7R4WA01# |
| | | | | ±0.1pF | GRM1555C1H7R4BA01# |
| | | | | ±0.25pF | GRM1555C1H7R4CA01# |
| | | | 7.5pF | ±0.05pF | GRM1555C1H7R5WA01# |
| | | | | ±0.1pF | GRM1555C1H7R5BA01# |
| | | | | ±0.25pF | GRM1555C1H7R5CA01# |
| | | | 7.6pF | ±0.05pF | GRM1555C1H7R6WA01# |
| | | | | ±0.1pF | GRM1555C1H7R6BA01# |
| | | | | ±0.25pF | GRM1555C1H7R6CA01# |
| | | | 7.7pF | ±0.05pF | GRM1555C1H7R7WA01# |
| | | | | ±0.1pF | GRM1555C1H7R7BA01# |
| | | | | ±0.25pF | GRM1555C1H7R7CA01# |

| T max. | Rated Voltage | TC Code | Cap. | Tol. | Part Number |
|--------|---------------|---------|---------|---------|--------------------|
| 0.55mm | 50Vdc | C0G | 7.7pF | ±0.5pF | GRM1555C1H7R7DA01# |
| | | | | ±0.05pF | GRM1555C1H7R8WA01# |
| | | | | ±0.1pF | GRM1555C1H7R8BA01# |
| | | | 7.8pF | ±0.25pF | GRM1555C1H7R8CA01# |
| | | | | ±0.5pF | GRM1555C1H7R8DA01# |
| | | | | 7.9pF | ±0.05pF |
| | | | ±0.1pF | | GRM1555C1H7R9BA01# |
| | | | ±0.25pF | | GRM1555C1H7R9CA01# |
| | | | 8.0pF | ±0.05pF | GRM1555C1H8R0WA01# |
| | | | | ±0.1pF | GRM1555C1H8R0BA01# |
| | | | | ±0.25pF | GRM1555C1H8R0CA01# |
| | | | 8.1pF | ±0.05pF | GRM1555C1H8R1WA01# |
| | | | | ±0.1pF | GRM1555C1H8R1BA01# |
| | | | | ±0.25pF | GRM1555C1H8R1CA01# |
| | | | 8.2pF | ±0.05pF | GRM1555C1H8R2WA01# |
| | | | | ±0.1pF | GRM1555C1H8R2BA01# |
| | | | | ±0.25pF | GRM1555C1H8R2CA01# |
| | | | 8.3pF | ±0.05pF | GRM1555C1H8R3WA01# |
| | | | | ±0.1pF | GRM1555C1H8R3BA01# |
| | | | | ±0.25pF | GRM1555C1H8R3CA01# |
| | | | 8.4pF | ±0.05pF | GRM1555C1H8R4WA01# |
| | | | | ±0.1pF | GRM1555C1H8R4BA01# |
| | | | | ±0.25pF | GRM1555C1H8R4CA01# |
| | | | 8.5pF | ±0.05pF | GRM1555C1H8R5WA01# |
| | | | | ±0.1pF | GRM1555C1H8R5BA01# |
| | | | | ±0.25pF | GRM1555C1H8R5CA01# |
| | | | 8.6pF | ±0.05pF | GRM1555C1H8R6WA01# |
| | | | | ±0.1pF | GRM1555C1H8R6BA01# |
| | | | | ±0.25pF | GRM1555C1H8R6CA01# |
| | | | 8.7pF | ±0.05pF | GRM1555C1H8R7WA01# |
| | | | | ±0.1pF | GRM1555C1H8R7BA01# |
| | | | | ±0.25pF | GRM1555C1H8R7CA01# |
| | | | 8.8pF | ±0.05pF | GRM1555C1H8R8WA01# |
| | | | | ±0.1pF | GRM1555C1H8R8BA01# |
| | | | | ±0.25pF | GRM1555C1H8R8CA01# |
| | | | 8.9pF | ±0.05pF | GRM1555C1H8R9WA01# |
| | | | | ±0.1pF | GRM1555C1H8R9BA01# |
| | | | | ±0.25pF | GRM1555C1H8R9CA01# |
| | | | 9.0pF | ±0.05pF | GRM1555C1H9R0WA01# |
| | | | | ±0.1pF | GRM1555C1H9R0BA01# |
| | | | | ±0.25pF | GRM1555C1H9R0CA01# |
| | | | 9.1pF | ±0.05pF | GRM1555C1H9R1WA01# |
| | | | | ±0.1pF | GRM1555C1H9R1BA01# |
| | | | | ±0.25pF | GRM1555C1H9R1CA01# |

Part number # indicates the package specification code.

GRM Series Temperature Compensating Type Part Number List

(→ ■ 1.0x0.5mm)

| T max. | Rated Voltage | TC Code | Cap. | Tol. | Part Number |
|--------|---------------|---------|-------|---------|--------------------|
| 0.55mm | 50Vdc | C0G | 9.1pF | ±0.1pF | GRM1555C1H9R1BA01# |
| | | | | ±0.25pF | GRM1555C1H9R1CA01# |
| | | | | ±0.5pF | GRM1555C1H9R1DA01# |
| | | | 9.2pF | ±0.05pF | GRM1555C1H9R2WA01# |
| | | | | ±0.1pF | GRM1555C1H9R2BA01# |
| | | | | ±0.25pF | GRM1555C1H9R2CA01# |
| | | | 9.3pF | ±0.05pF | GRM1555C1H9R3WA01# |
| | | | | ±0.1pF | GRM1555C1H9R3BA01# |
| | | | | ±0.25pF | GRM1555C1H9R3CA01# |
| | | | 9.4pF | ±0.05pF | GRM1555C1H9R4WA01# |
| | | | | ±0.1pF | GRM1555C1H9R4BA01# |
| | | | | ±0.25pF | GRM1555C1H9R4CA01# |
| | | | 9.5pF | ±0.05pF | GRM1555C1H9R5WA01# |
| | | | | ±0.1pF | GRM1555C1H9R5BA01# |
| | | | | ±0.25pF | GRM1555C1H9R5CA01# |
| | | | 9.6pF | ±0.05pF | GRM1555C1H9R6WA01# |
| | | | | ±0.1pF | GRM1555C1H9R6BA01# |
| | | | | ±0.25pF | GRM1555C1H9R6CA01# |
| | | | 9.7pF | ±0.05pF | GRM1555C1H9R7WA01# |
| | | | | ±0.1pF | GRM1555C1H9R7BA01# |
| | | | | ±0.25pF | GRM1555C1H9R7CA01# |
| | | | 9.8pF | ±0.05pF | GRM1555C1H9R8WA01# |
| | | | | ±0.1pF | GRM1555C1H9R8BA01# |
| | | | | ±0.25pF | GRM1555C1H9R8CA01# |
| | | | 9.9pF | ±0.05pF | GRM1555C1H9R9WA01# |
| | | | | ±0.1pF | GRM1555C1H9R9BA01# |
| | | | | ±0.25pF | GRM1555C1H9R9CA01# |
| | | | 10pF | ±2% | GRM1555C1H100GA01# |
| | | | | ±5% | GRM1555C1H100JA01# |
| | | | 12pF | ±2% | GRM1555C1H120GA01# |
| | | | | ±5% | GRM1555C1H120JA01# |
| | | | 15pF | ±2% | GRM1555C1H150GA01# |
| | | | | ±5% | GRM1555C1H150JA01# |
| | | | 18pF | ±2% | GRM1555C1H180GA01# |
| | | | | ±5% | GRM1555C1H180JA01# |
| | | | 22pF | ±2% | GRM1555C1H220GA01# |
| | | | | ±5% | GRM1555C1H220JA01# |
| | | | 27pF | ±2% | GRM1555C1H270GA01# |
| | | | | ±5% | GRM1555C1H270JA01# |
| | | | 33pF | ±2% | GRM1555C1H330GA01# |
| | | | | ±5% | GRM1555C1H330JA01# |
| | | | 39pF | ±2% | GRM1555C1H390GA01# |
| | | | | ±5% | GRM1555C1H390JA01# |
| | | | 47pF | ±2% | GRM1555C1H470GA01# |
| | | | | ±5% | GRM1555C1H470JA01# |
| | | | 56pF | ±2% | GRM1555C1H560GA01# |

| T max. | Rated Voltage | TC Code | Cap. | Tol. | Part Number | |
|--------|---------------|--------------------|--------|---------|--------------------|--------------------|
| 0.55mm | 50Vdc | C0G | 56pF | ±5% | GRM1555C1H560JA01# | |
| | | | | ±2% | GRM1555C1H680GA01# | |
| | | | 68pF | ±5% | GRM1555C1H680JA01# | |
| | | | | ±2% | GRM1555C1H820GA01# | |
| | | | 82pF | ±5% | GRM1555C1H820JA01# | |
| | | | | ±2% | GRM1555C1H101GA01# | |
| | | | 100pF | ±5% | GRM1555C1H101JA01# | |
| | | | | ±2% | GRM1555C1H121GA01# | |
| | | | 120pF | ±5% | GRM1555C1H121JA01# | |
| | | | | ±2% | GRM1555C1H151GA01# | |
| | | | 150pF | ±5% | GRM1555C1H151JA01# | |
| | | | | ±2% | GRM1555C1H181GA01# | |
| | | | 180pF | ±5% | GRM1555C1H181JA01# | |
| | | | | ±2% | GRM1555C1H221GA01# | |
| | | | 220pF | ±5% | GRM1555C1H221JA01# | |
| | | | | ±2% | GRM1555C1H271GA01# | |
| | | | 270pF | ±5% | GRM1555C1H271JA01# | |
| | | | | ±2% | GRM1555C1H331GA01# | |
| | | | 330pF | ±5% | GRM1555C1H331JA01# | |
| | | | | ±2% | GRM1555C1H391GA01# | |
| | | | 390pF | ±5% | GRM1555C1H391JA01# | |
| | | | | ±2% | GRM1555C1H471GA01# | |
| | | | 470pF | ±5% | GRM1555C1H471JA01# | |
| | | | | ±2% | GRM1555C1H561GA01# | |
| | | | 560pF | ±5% | GRM1555C1H561JA01# | |
| | | | | ±2% | GRM1555C1H681GA01# | |
| | | | 680pF | ±5% | GRM1555C1H681JA01# | |
| | | | | ±2% | GRM1555C1H821GA01# | |
| | | | 820pF | ±5% | GRM1555C1H821JA01# | |
| | | | | ±2% | GRM1555C1H102GA01# | |
| | | | 1000pF | ±5% | GRM1555C1H102JA01# | |
| | | | | CK | 0.1pF | ±0.05pF |
| | | | ±0.1pF | | | GRM1554C1HR10BA01# |
| | | | 0.2pF | ±0.05pF | GRM1554C1HR20WA01# | |
| | | | | ±0.1pF | GRM1554C1HR20BA01# | |
| | | | 0.3pF | ±0.05pF | GRM1554C1HR30WA01# | |
| | | | | ±0.1pF | GRM1554C1HR30BA01# | |
| | | | 0.4pF | ±0.05pF | GRM1554C1HR40WA01# | |
| | | | | ±0.1pF | GRM1554C1HR40BA01# | |
| | | | 0.5pF | ±0.05pF | GRM1554C1HR50WA01# | |
| | | | | ±0.1pF | GRM1554C1HR50BA01# | |
| | | | 0.6pF | ±0.05pF | GRM1554C1HR60WA01# | |
| | | | | ±0.1pF | GRM1554C1HR60BA01# | |
| | | | 0.7pF | ±0.05pF | GRM1554C1HR70WA01# | |
| | | | | ±0.1pF | GRM1554C1HR70BA01# | |
| 0.8pF | ±0.05pF | GRM1554C1HR80WA01# | | | | |
| | ±0.1pF | GRM1554C1HR80BA01# | | | | |
| 0.9pF | ±0.05pF | GRM1554C1HR90WA01# | | | | |
| | ±0.1pF | GRM1554C1HR90BA01# | | | | |
| 1.0pF | ±0.05pF | GRM1554C1H1R0WA01# | | | | |
| | ±0.1pF | GRM1554C1H1R0BA01# | | | | |
| | ±0.25pF | GRM1554C1H1R0CA01# | | | | |
| 1.1pF | ±0.05pF | GRM1554C1H1R1WA01# | | | | |
| | ±0.1pF | GRM1554C1H1R1BA01# | | | | |

Part number # indicates the package specification code.

For General Purpose GRM Series

Capacitor Array GNM Series

Low ESL LLI Series

High-Q Type GJM Series

High Frequency GQM Series

Monolithic Microchip GMA Series

For Bonding GMD Series

Product Information

GRM Series Temperature Compensating Type Part Number List

(→ ■ 1.0x0.5mm)

| T max. | Rated Voltage | TC Code | Cap. | Tol. | Part Number | | |
|--------|---------------|---------|---------|--------------------|--------------------|--------------------|--------------------|
| 0.55mm | 50Vdc | CK | 1.1pF | ±0.25pF | GRM1554C1H1R1CA01# | | |
| | | | | ±0.05pF | GRM1554C1H1R2WA01# | | |
| | | | | | ±0.1pF | GRM1554C1H1R2BA01# | |
| | | | ±0.25pF | GRM1554C1H1R2CA01# | | | |
| | | | | 1.3pF | ±0.05pF | GRM1554C1H1R3WA01# | |
| | | | | | ±0.1pF | GRM1554C1H1R3BA01# | |
| | | | ±0.25pF | | GRM1554C1H1R3CA01# | | |
| | | | 1.4pF | ±0.05pF | GRM1554C1H1R4WA01# | | |
| | | | | ±0.1pF | GRM1554C1H1R4BA01# | | |
| | | | | ±0.25pF | GRM1554C1H1R4CA01# | | |
| | | | 1.5pF | ±0.05pF | GRM1554C1H1R5WA01# | | |
| | | | | ±0.1pF | GRM1554C1H1R5BA01# | | |
| | | | | ±0.25pF | GRM1554C1H1R5CA01# | | |
| | | | 1.6pF | ±0.05pF | GRM1554C1H1R6WA01# | | |
| | | | | ±0.1pF | GRM1554C1H1R6BA01# | | |
| | | | | ±0.25pF | GRM1554C1H1R6CA01# | | |
| | | | 1.7pF | ±0.05pF | GRM1554C1H1R7WA01# | | |
| | | | | ±0.1pF | GRM1554C1H1R7BA01# | | |
| | | | | ±0.25pF | GRM1554C1H1R7CA01# | | |
| | | | 1.8pF | ±0.05pF | GRM1554C1H1R8WA01# | | |
| | | | | ±0.1pF | GRM1554C1H1R8BA01# | | |
| | | | | ±0.25pF | GRM1554C1H1R8CA01# | | |
| | | | 1.9pF | ±0.05pF | GRM1554C1H1R9WA01# | | |
| | | | | ±0.1pF | GRM1554C1H1R9BA01# | | |
| | | | | ±0.25pF | GRM1554C1H1R9CA01# | | |
| | | | 2.0pF | ±0.05pF | GRM1554C1H2R0WA01# | | |
| | | | | ±0.1pF | GRM1554C1H2R0BA01# | | |
| | | | | ±0.25pF | GRM1554C1H2R0CA01# | | |
| | | | CJ | 50Vdc | 2.1pF | ±0.05pF | GRM1553C1H2R1WA01# |
| | | | | | | ±0.1pF | GRM1553C1H2R1BA01# |
| | | | | | | ±0.25pF | GRM1553C1H2R1CA01# |
| | | | | | 2.2pF | ±0.05pF | GRM1553C1H2R2WA01# |
| | | | | | | ±0.1pF | GRM1553C1H2R2BA01# |
| | | | | | | ±0.25pF | GRM1553C1H2R2CA01# |
| | | | | | 2.3pF | ±0.05pF | GRM1553C1H2R3WA01# |
| | | | | | | ±0.1pF | GRM1553C1H2R3BA01# |
| | | ±0.25pF | | | | GRM1553C1H2R3CA01# | |
| | | 2.4pF | | | ±0.05pF | GRM1553C1H2R4WA01# | |
| | | | | | ±0.1pF | GRM1553C1H2R4BA01# | |
| | | | | | ±0.25pF | GRM1553C1H2R4CA01# | |
| | | 2.5pF | | | ±0.05pF | GRM1553C1H2R5WA01# | |
| | | | | | ±0.1pF | GRM1553C1H2R5BA01# | |
| | | | | | ±0.25pF | GRM1553C1H2R5CA01# | |
| | | 2.6pF | | | ±0.05pF | GRM1553C1H2R6WA01# | |
| | | | | | ±0.1pF | GRM1553C1H2R6BA01# | |
| | | | | | ±0.25pF | GRM1553C1H2R6CA01# | |
| | | 2.7pF | | | ±0.05pF | GRM1553C1H2R7WA01# | |
| | | | | | ±0.1pF | GRM1553C1H2R7BA01# | |
| | | | | | ±0.25pF | GRM1553C1H2R7CA01# | |
| | | 2.8pF | | | ±0.05pF | GRM1553C1H2R8WA01# | |
| | | | | | ±0.1pF | GRM1553C1H2R8BA01# | |
| | | | | | ±0.25pF | GRM1553C1H2R8CA01# | |
| | | 2.9pF | | | ±0.05pF | GRM1553C1H2R9WA01# | |
| | | | | | ±0.1pF | GRM1553C1H2R9BA01# | |

| T max. | Rated Voltage | TC Code | Cap. | Tol. | Part Number | | |
|--------|---------------|---------|---------|--------------------|--------------------|--------------------|--------------------|
| 0.55mm | 50Vdc | CJ | 2.9pF | ±0.25pF | GRM1553C1H2R9CA01# | | |
| | | | | ±0.05pF | GRM1553C1H3R0WA01# | | |
| | | | | | ±0.1pF | GRM1553C1H3R0BA01# | |
| | | | ±0.25pF | GRM1553C1H3R0CA01# | | | |
| | | | | 3.1pF | ±0.05pF | GRM1553C1H3R1WA01# | |
| | | | | | ±0.1pF | GRM1553C1H3R1BA01# | |
| | | | ±0.25pF | | GRM1553C1H3R1CA01# | | |
| | | | 3.2pF | ±0.05pF | GRM1553C1H3R2WA01# | | |
| | | | | ±0.1pF | GRM1553C1H3R2BA01# | | |
| | | | | ±0.25pF | GRM1553C1H3R2CA01# | | |
| | | | 3.3pF | ±0.05pF | GRM1553C1H3R3WA01# | | |
| | | | | ±0.1pF | GRM1553C1H3R3BA01# | | |
| | | | | ±0.25pF | GRM1553C1H3R3CA01# | | |
| | | | 3.4pF | ±0.05pF | GRM1553C1H3R4WA01# | | |
| | | | | ±0.1pF | GRM1553C1H3R4BA01# | | |
| | | | | ±0.25pF | GRM1553C1H3R4CA01# | | |
| | | | 3.5pF | ±0.05pF | GRM1553C1H3R5WA01# | | |
| | | | | ±0.1pF | GRM1553C1H3R5BA01# | | |
| | | | | ±0.25pF | GRM1553C1H3R5CA01# | | |
| | | | 3.6pF | ±0.05pF | GRM1553C1H3R6WA01# | | |
| | | | | ±0.1pF | GRM1553C1H3R6BA01# | | |
| | | | | ±0.25pF | GRM1553C1H3R6CA01# | | |
| | | | 3.7pF | ±0.05pF | GRM1553C1H3R7WA01# | | |
| | | | | ±0.1pF | GRM1553C1H3R7BA01# | | |
| | | | | ±0.25pF | GRM1553C1H3R7CA01# | | |
| | | | 3.8pF | ±0.05pF | GRM1553C1H3R8WA01# | | |
| | | | | ±0.1pF | GRM1553C1H3R8BA01# | | |
| | | | | ±0.25pF | GRM1553C1H3R8CA01# | | |
| | | | 3.9pF | ±0.05pF | GRM1553C1H3R9WA01# | | |
| | | | | ±0.1pF | GRM1553C1H3R9BA01# | | |
| | | | | ±0.25pF | GRM1553C1H3R9CA01# | | |
| | | | CH | 50Vdc | 4.0pF | ±0.05pF | GRM1552C1H4R0WA01# |
| | | | | | | ±0.1pF | GRM1552C1H4R0BA01# |
| | | | | | | ±0.25pF | GRM1552C1H4R0CA01# |
| | | | | | 4.1pF | ±0.05pF | GRM1552C1H4R1WA01# |
| | | | | | | ±0.1pF | GRM1552C1H4R1BA01# |
| | | ±0.25pF | | | | GRM1552C1H4R1CA01# | |
| | | 4.2pF | | | ±0.05pF | GRM1552C1H4R2WA01# | |
| | | | | | ±0.1pF | GRM1552C1H4R2BA01# | |
| | | | | | ±0.25pF | GRM1552C1H4R2CA01# | |
| | | 4.3pF | | | ±0.05pF | GRM1552C1H4R3WA01# | |
| | | | | | ±0.1pF | GRM1552C1H4R3BA01# | |
| | | | | | ±0.25pF | GRM1552C1H4R3CA01# | |
| | | 4.4pF | | | ±0.05pF | GRM1552C1H4R4WA01# | |
| | | | | | ±0.1pF | GRM1552C1H4R4BA01# | |
| | | | | | ±0.25pF | GRM1552C1H4R4CA01# | |
| | | 4.5pF | | | ±0.05pF | GRM1552C1H4R5WA01# | |
| | | | | | ±0.1pF | GRM1552C1H4R5BA01# | |
| | | | | | ±0.25pF | GRM1552C1H4R5CA01# | |
| | | 4.6pF | | | ±0.05pF | GRM1552C1H4R6WA01# | |
| | | | | | ±0.1pF | GRM1552C1H4R6BA01# | |
| | | | | | ±0.25pF | GRM1552C1H4R6CA01# | |
| | | 4.7pF | | | ±0.05pF | GRM1552C1H4R7WA01# | |
| | | | | | ±0.1pF | GRM1552C1H4R7BA01# | |

Part number # indicates the package specification code.

For General Purpose GRM Series
 Capacitor Array GNM Series
 Low ESL LL□ Series
 High-Q Type GJM Series
 High Frequency GQM Series
 Monolithic Microchip GMA Series
 For Bonding GMD Series
 Product Information

GRM Series Temperature Compensating Type Part Number List

(→ ■ 1.0x0.5mm)

| T max. | Rated Voltage | TC Code | Cap. | Tol. | Part Number | | T max. | Rated Voltage | TC Code | Cap. | Tol. | Part Number | | | |
|--------|---------------|---------|---------|---------|--------------------|--------------------|--------|---------------|---------|---------|--------------------|--------------------|---------|--------------------|--|
| 0.55mm | 50Vdc | CH | 4.7pF | ±0.25pF | GRM1552C1H4R7CA01# | | 0.55mm | 50Vdc | CH | 6.2pF | ±0.05pF | GRM1552C1H6R2WA01# | | | |
| | | | | ±0.05pF | GRM1552C1H4R8WA01# | | | | | | ±0.1pF | GRM1552C1H6R2BA01# | | | |
| | | | | ±0.1pF | GRM1552C1H4R8BA01# | | | | | | ±0.25pF | GRM1552C1H6R2CA01# | | | |
| | | | | ±0.25pF | GRM1552C1H4R8CA01# | | | | | | ±0.5pF | GRM1552C1H6R2DA01# | | | |
| | | | 4.9pF | ±0.05pF | GRM1552C1H4R9WA01# | | | | | 6.3pF | ±0.05pF | GRM1552C1H6R3WA01# | | | |
| | | | | ±0.1pF | GRM1552C1H4R9BA01# | | | | | | ±0.1pF | GRM1552C1H6R3BA01# | | | |
| | | | | ±0.25pF | GRM1552C1H4R9CA01# | | | | | | ±0.25pF | GRM1552C1H6R3CA01# | | | |
| | | | | ±0.5pF | GRM1552C1H4R9DA01# | | | | | | ±0.5pF | GRM1552C1H6R3DA01# | | | |
| | | | | 5.0pF | ±0.05pF | GRM1552C1H5R0WA01# | | | | | | 6.4pF | ±0.05pF | GRM1552C1H6R4WA01# | |
| | | | | | ±0.1pF | GRM1552C1H5R0BA01# | | | | | | | ±0.1pF | GRM1552C1H6R4BA01# | |
| | | | ±0.25pF | | GRM1552C1H5R0CA01# | | | | | ±0.25pF | GRM1552C1H6R4CA01# | | | | |
| | | | 5.1pF | ±0.05pF | GRM1552C1H5R1WA01# | | | | | 6.5pF | ±0.05pF | GRM1552C1H6R5WA01# | | | |
| | | | | ±0.1pF | GRM1552C1H5R1BA01# | | | | | | ±0.1pF | GRM1552C1H6R5BA01# | | | |
| | | | | ±0.25pF | GRM1552C1H5R1CA01# | | | | | | ±0.25pF | GRM1552C1H6R5CA01# | | | |
| | | | | ±0.5pF | GRM1552C1H5R1DA01# | | | | | | ±0.5pF | GRM1552C1H6R5DA01# | | | |
| | | | 5.2pF | ±0.05pF | GRM1552C1H5R2WA01# | | | | | 6.6pF | ±0.05pF | GRM1552C1H6R6WA01# | | | |
| | | | | ±0.1pF | GRM1552C1H5R2BA01# | | | | | | ±0.1pF | GRM1552C1H6R6BA01# | | | |
| | | | | ±0.25pF | GRM1552C1H5R2CA01# | | | | | | ±0.25pF | GRM1552C1H6R6CA01# | | | |
| | | | | ±0.5pF | GRM1552C1H5R2DA01# | | | | | | ±0.5pF | GRM1552C1H6R6DA01# | | | |
| | | | 5.3pF | ±0.05pF | GRM1552C1H5R3WA01# | | | | | 6.7pF | ±0.05pF | GRM1552C1H6R7WA01# | | | |
| | | | | ±0.1pF | GRM1552C1H5R3BA01# | | | | | | ±0.1pF | GRM1552C1H6R7BA01# | | | |
| | | | | ±0.25pF | GRM1552C1H5R3CA01# | | | | | | ±0.25pF | GRM1552C1H6R7CA01# | | | |
| | | | | ±0.5pF | GRM1552C1H5R3DA01# | | | | | | ±0.5pF | GRM1552C1H6R7DA01# | | | |
| | | | 5.4pF | ±0.05pF | GRM1552C1H5R4WA01# | | | | | 6.8pF | ±0.05pF | GRM1552C1H6R8WA01# | | | |
| | | | | ±0.1pF | GRM1552C1H5R4BA01# | | | | | | ±0.1pF | GRM1552C1H6R8BA01# | | | |
| | | | | ±0.25pF | GRM1552C1H5R4CA01# | | | | | | ±0.25pF | GRM1552C1H6R8CA01# | | | |
| | | | | ±0.5pF | GRM1552C1H5R4DA01# | | | | | | ±0.5pF | GRM1552C1H6R8DA01# | | | |
| | | | 5.5pF | ±0.05pF | GRM1552C1H5R5WA01# | | | | | 6.9pF | ±0.05pF | GRM1552C1H6R9WA01# | | | |
| | | | | ±0.1pF | GRM1552C1H5R5BA01# | | | | | | ±0.1pF | GRM1552C1H6R9BA01# | | | |
| | | | | ±0.25pF | GRM1552C1H5R5CA01# | | | | | | ±0.25pF | GRM1552C1H6R9CA01# | | | |
| | | | | ±0.5pF | GRM1552C1H5R5DA01# | | | | | | ±0.5pF | GRM1552C1H6R9DA01# | | | |
| | | | 5.6pF | ±0.05pF | GRM1552C1H5R6WA01# | | | | | 7.0pF | ±0.05pF | GRM1552C1H7R0WA01# | | | |
| | | | | ±0.1pF | GRM1552C1H5R6BA01# | | | | | | ±0.1pF | GRM1552C1H7R0BA01# | | | |
| | | | | ±0.25pF | GRM1552C1H5R6CA01# | | | | | | ±0.25pF | GRM1552C1H7R0CA01# | | | |
| | | | | ±0.5pF | GRM1552C1H5R6DA01# | | | | | | ±0.5pF | GRM1552C1H7R0DA01# | | | |
| | | | 5.7pF | ±0.05pF | GRM1552C1H5R7WA01# | | | | | 7.1pF | ±0.05pF | GRM1552C1H7R1WA01# | | | |
| | | | | ±0.1pF | GRM1552C1H5R7BA01# | | | | | | ±0.1pF | GRM1552C1H7R1BA01# | | | |
| | | | | ±0.25pF | GRM1552C1H5R7CA01# | | | | | | ±0.25pF | GRM1552C1H7R1CA01# | | | |
| | | | | ±0.5pF | GRM1552C1H5R7DA01# | | | | | | ±0.5pF | GRM1552C1H7R1DA01# | | | |
| | | | 5.8pF | ±0.05pF | GRM1552C1H5R8WA01# | | | | | 7.2pF | ±0.05pF | GRM1552C1H7R2WA01# | | | |
| | | | | ±0.1pF | GRM1552C1H5R8BA01# | | | | | | ±0.1pF | GRM1552C1H7R2BA01# | | | |
| | | | | ±0.25pF | GRM1552C1H5R8CA01# | | | | | | ±0.25pF | GRM1552C1H7R2CA01# | | | |
| | | | | ±0.5pF | GRM1552C1H5R8DA01# | | | | | | ±0.5pF | GRM1552C1H7R2DA01# | | | |
| | | | 5.9pF | ±0.05pF | GRM1552C1H5R9WA01# | | | | | 7.3pF | ±0.05pF | GRM1552C1H7R3WA01# | | | |
| | | | | ±0.1pF | GRM1552C1H5R9BA01# | | | | | | ±0.1pF | GRM1552C1H7R3BA01# | | | |
| | | | | ±0.25pF | GRM1552C1H5R9CA01# | | | | | | ±0.25pF | GRM1552C1H7R3CA01# | | | |
| | | | | ±0.5pF | GRM1552C1H5R9DA01# | | | | | | ±0.5pF | GRM1552C1H7R3DA01# | | | |
| | | | 6.0pF | ±0.05pF | GRM1552C1H6R0WA01# | | | | | 7.4pF | ±0.05pF | GRM1552C1H7R4WA01# | | | |
| | | | | ±0.1pF | GRM1552C1H6R0BA01# | | | | | | ±0.1pF | GRM1552C1H7R4BA01# | | | |
| | | | | ±0.25pF | GRM1552C1H6R0CA01# | | | | | | ±0.25pF | GRM1552C1H7R4CA01# | | | |
| | | | | ±0.5pF | GRM1552C1H6R0DA01# | | | | | | ±0.5pF | GRM1552C1H7R4DA01# | | | |
| | | | 6.1pF | ±0.05pF | GRM1552C1H6R1WA01# | | | | | 7.5pF | ±0.05pF | GRM1552C1H7R5WA01# | | | |
| | | | | ±0.1pF | GRM1552C1H6R1BA01# | | | | | | ±0.1pF | GRM1552C1H7R5BA01# | | | |
| | | | | ±0.25pF | GRM1552C1H6R1CA01# | | | | | | | | | | |
| | | | | ±0.5pF | GRM1552C1H6R1DA01# | | | | | | | | | | |

Part number # indicates the package specification code.

For General Purpose GRM Series

Capacitor Array GNM Series

Low ESL LLI Series

High-Q Type GJM Series

High Frequency GQM Series

Monolithic Microchip GMA Series

For Bonding GMD Series

Product Information

GRM Series Temperature Compensating Type Part Number List

(→ ■ 1.0x0.5mm)

| T max. | Rated Voltage | TC Code | Cap. | Tol. | Part Number |
|---------|--------------------|--------------------|-------|---------|--------------------|
| 0.55mm | 50Vdc | CH | 7.5pF | ±0.25pF | GRM1552C1H7R5CA01# |
| | | | | ±0.5pF | GRM1552C1H7R5DA01# |
| | | | 7.6pF | ±0.05pF | GRM1552C1H7R6WA01# |
| | | | | ±0.1pF | GRM1552C1H7R6BA01# |
| | | | | ±0.25pF | GRM1552C1H7R6CA01# |
| | | | | ±0.5pF | GRM1552C1H7R6DA01# |
| | | | 7.7pF | ±0.05pF | GRM1552C1H7R7WA01# |
| | | | | ±0.1pF | GRM1552C1H7R7BA01# |
| | | | | ±0.25pF | GRM1552C1H7R7CA01# |
| | | | | ±0.5pF | GRM1552C1H7R7DA01# |
| | | | 7.8pF | ±0.05pF | GRM1552C1H7R8WA01# |
| | | | | ±0.1pF | GRM1552C1H7R8BA01# |
| | | | | ±0.25pF | GRM1552C1H7R8CA01# |
| | | | | ±0.5pF | GRM1552C1H7R8DA01# |
| | | | 7.9pF | ±0.05pF | GRM1552C1H7R9WA01# |
| | | | | ±0.1pF | GRM1552C1H7R9BA01# |
| | | | | ±0.25pF | GRM1552C1H7R9CA01# |
| | | | | ±0.5pF | GRM1552C1H7R9DA01# |
| | | | 8.0pF | ±0.05pF | GRM1552C1H8R0WA01# |
| | | | | ±0.1pF | GRM1552C1H8R0BA01# |
| | | | | ±0.25pF | GRM1552C1H8R0CA01# |
| | | | | ±0.5pF | GRM1552C1H8R0DA01# |
| | | | 8.1pF | ±0.05pF | GRM1552C1H8R1WA01# |
| | | | | ±0.1pF | GRM1552C1H8R1BA01# |
| | | | | ±0.25pF | GRM1552C1H8R1CA01# |
| | | | | ±0.5pF | GRM1552C1H8R1DA01# |
| | | | 8.2pF | ±0.05pF | GRM1552C1H8R2WA01# |
| | | | | ±0.1pF | GRM1552C1H8R2BA01# |
| | | | | ±0.25pF | GRM1552C1H8R2CA01# |
| | | | | ±0.5pF | GRM1552C1H8R2DA01# |
| | | | 8.3pF | ±0.05pF | GRM1552C1H8R3WA01# |
| | | | | ±0.1pF | GRM1552C1H8R3BA01# |
| | | | | ±0.25pF | GRM1552C1H8R3CA01# |
| | | | | ±0.5pF | GRM1552C1H8R3DA01# |
| | | | 8.4pF | ±0.05pF | GRM1552C1H8R4WA01# |
| | | | | ±0.1pF | GRM1552C1H8R4BA01# |
| | | | | ±0.25pF | GRM1552C1H8R4CA01# |
| | | | | ±0.5pF | GRM1552C1H8R4DA01# |
| | | | 8.5pF | ±0.05pF | GRM1552C1H8R5WA01# |
| | | | | ±0.1pF | GRM1552C1H8R5BA01# |
| | | | | ±0.25pF | GRM1552C1H8R5CA01# |
| | | | | ±0.5pF | GRM1552C1H8R5DA01# |
| | | | 8.6pF | ±0.05pF | GRM1552C1H8R6WA01# |
| | | | | ±0.1pF | GRM1552C1H8R6BA01# |
| | | | | ±0.25pF | GRM1552C1H8R6CA01# |
| | | | | ±0.5pF | GRM1552C1H8R6DA01# |
| | | | 8.7pF | ±0.05pF | GRM1552C1H8R7WA01# |
| | | | | ±0.1pF | GRM1552C1H8R7BA01# |
| ±0.25pF | GRM1552C1H8R7CA01# | | | | |
| ±0.5pF | GRM1552C1H8R7DA01# | | | | |
| 8.8pF | ±0.05pF | GRM1552C1H8R8WA01# | | | |
| | ±0.1pF | GRM1552C1H8R8BA01# | | | |
| | ±0.25pF | GRM1552C1H8R8CA01# | | | |
| | ±0.5pF | GRM1552C1H8R8DA01# | | | |

| T max. | Rated Voltage | TC Code | Cap. | Tol. | Part Number |
|--------|---------------|---------|-------|---------|--------------------|
| 0.55mm | 50Vdc | CH | 8.9pF | ±0.05pF | GRM1552C1H8R9WA01# |
| | | | | ±0.1pF | GRM1552C1H8R9BA01# |
| | | | | ±0.25pF | GRM1552C1H8R9CA01# |
| | | | | ±0.5pF | GRM1552C1H8R9DA01# |
| | | | 9.0pF | ±0.05pF | GRM1552C1H9R0WA01# |
| | | | | ±0.1pF | GRM1552C1H9R0BA01# |
| | | | | ±0.25pF | GRM1552C1H9R0CA01# |
| | | | 9.1pF | ±0.05pF | GRM1552C1H9R1WA01# |
| | | | | ±0.1pF | GRM1552C1H9R1BA01# |
| | | | | ±0.25pF | GRM1552C1H9R1CA01# |
| | | | 9.2pF | ±0.05pF | GRM1552C1H9R2WA01# |
| | | | | ±0.1pF | GRM1552C1H9R2BA01# |
| | | | | ±0.25pF | GRM1552C1H9R2CA01# |
| | | | 9.3pF | ±0.05pF | GRM1552C1H9R3WA01# |
| | | | | ±0.1pF | GRM1552C1H9R3BA01# |
| | | | | ±0.25pF | GRM1552C1H9R3CA01# |
| | | | 9.4pF | ±0.05pF | GRM1552C1H9R4WA01# |
| | | | | ±0.1pF | GRM1552C1H9R4BA01# |
| | | | | ±0.25pF | GRM1552C1H9R4CA01# |
| | | | 9.5pF | ±0.05pF | GRM1552C1H9R5WA01# |
| | | | | ±0.1pF | GRM1552C1H9R5BA01# |
| | | | | ±0.25pF | GRM1552C1H9R5CA01# |
| | | | 9.6pF | ±0.05pF | GRM1552C1H9R6WA01# |
| | | | | ±0.1pF | GRM1552C1H9R6BA01# |
| | | | | ±0.25pF | GRM1552C1H9R6CA01# |
| | | | 9.7pF | ±0.05pF | GRM1552C1H9R7WA01# |
| | | | | ±0.1pF | GRM1552C1H9R7BA01# |
| | | | | ±0.25pF | GRM1552C1H9R7CA01# |
| | | | 9.8pF | ±0.05pF | GRM1552C1H9R8WA01# |
| | | | | ±0.1pF | GRM1552C1H9R8BA01# |
| | | | | ±0.25pF | GRM1552C1H9R8CA01# |
| | | | 9.9pF | ±0.05pF | GRM1552C1H9R9WA01# |
| | | | | ±0.1pF | GRM1552C1H9R9BA01# |
| | | | | ±0.25pF | GRM1552C1H9R9CA01# |
| | | | 10pF | ±2% | GRM1552C1H100GA01# |
| | | | | ±5% | GRM1552C1H100JA01# |
| | | | 12pF | ±2% | GRM1552C1H120GA01# |
| | | | | ±5% | GRM1552C1H120JA01# |
| | | | 15pF | ±2% | GRM1552C1H150GA01# |
| | | | | ±5% | GRM1552C1H150JA01# |
| | | | 18pF | ±2% | GRM1552C1H180GA01# |
| | | | | ±5% | GRM1552C1H180JA01# |
| | | | 22pF | ±2% | GRM1552C1H220GA01# |
| | | | | ±5% | GRM1552C1H220JA01# |

Part number # indicates the package specification code.

For General Purpose
GRM Series

Capacitor Array
GNM Series

Low ESL
LL□ Series

High-Q Type
GJM Series

High Frequency
GQM Series

Monolithic Microchip
GMA Series

For Bonding
GMD Series

Product Information

GRM Series Temperature Compensating Type Part Number List

(→ ■ 1.0x0.5mm)

| T max. | Rated Voltage | TC Code | Cap. | Tol. | Part Number | | | |
|--------|---------------|--------------------|--------------------|---------|--------------------|--------------------|--------------------|--|
| 0.55mm | 50Vdc | CH | 27pF | ±2% | GRM1552C1H270GA01# | | | |
| | | | | ±5% | GRM1552C1H270JA01# | | | |
| | | | 33pF | ±2% | GRM1552C1H330GA01# | | | |
| | | | | ±5% | GRM1552C1H330JA01# | | | |
| | | | 39pF | ±2% | GRM1552C1H390GA01# | | | |
| | | | | ±5% | GRM1552C1H390JA01# | | | |
| | | | 47pF | ±2% | GRM1552C1H470GA01# | | | |
| | | | | ±5% | GRM1552C1H470JA01# | | | |
| | | | 56pF | ±2% | GRM1552C1H560GA01# | | | |
| | | | | ±5% | GRM1552C1H560JA01# | | | |
| | | | 68pF | ±2% | GRM1552C1H680GA01# | | | |
| | | | | ±5% | GRM1552C1H680JA01# | | | |
| | | | 82pF | ±2% | GRM1552C1H820GA01# | | | |
| | | | | ±5% | GRM1552C1H820JA01# | | | |
| | | | 100pF | ±2% | GRM1552C1H101GA01# | | | |
| | | | | ±5% | GRM1552C1H101JA01# | | | |
| | | | 120pF | ±2% | GRM1552C1H121GA01# | | | |
| | | | | ±5% | GRM1552C1H121JA01# | | | |
| | | | 150pF | ±2% | GRM1552C1H151GA01# | | | |
| | | | | ±5% | GRM1552C1H151JA01# | | | |
| | | | 180pF | ±2% | GRM1552C1H181GA01# | | | |
| | | | | ±5% | GRM1552C1H181JA01# | | | |
| | | | 220pF | ±2% | GRM1552C1H221GA01# | | | |
| | | | | ±5% | GRM1552C1H221JA01# | | | |
| | | | 270pF | ±2% | GRM1552C1H271GA01# | | | |
| | | | | ±5% | GRM1552C1H271JA01# | | | |
| | | | 330pF | ±2% | GRM1552C1H331GA01# | | | |
| | | | | ±5% | GRM1552C1H331JA01# | | | |
| | | | 390pF | ±2% | GRM1552C1H391GA01# | | | |
| | | | | ±5% | GRM1552C1H391JA01# | | | |
| | | | 470pF | ±2% | GRM1552C1H471GA01# | | | |
| | | | | ±5% | GRM1552C1H471JA01# | | | |
| | | | 560pF | ±2% | GRM1552C1H561GA01# | | | |
| | | | | ±5% | GRM1552C1H561JA01# | | | |
| | | | 680pF | ±2% | GRM1552C1H681GA01# | | | |
| | | | | ±5% | GRM1552C1H681JA01# | | | |
| | | | 820pF | ±2% | GRM1552C1H821GA01# | | | |
| | | | | ±5% | GRM1552C1H821JA01# | | | |
| | | | 1000pF | ±2% | GRM1552C1H102GA01# | | | |
| | | | | ±5% | GRM1552C1H102JA01# | | | |
| | | | P2H | 1.0pF | ±0.25pF | GRM1556P1H1R0CZ01# | | |
| | | | | 2.0pF | ±0.25pF | GRM1556P1H2R0CZ01# | | |
| | | | | 3.0pF | ±0.25pF | GRM1556P1H3R0CZ01# | | |
| | | | | 4.0pF | ±0.25pF | GRM1556P1H4R0CZ01# | | |
| | | | | 5.0pF | ±0.25pF | GRM1556P1H5R0CZ01# | | |
| | | | | 6.0pF | ±0.5pF | GRM1556P1H6R0DZ01# | | |
| | | | | 7.0pF | ±0.5pF | GRM1556P1H7R0DZ01# | | |
| | | | | 8.0pF | ±0.5pF | GRM1556P1H8R0DZ01# | | |
| | | | | 9.0pF | ±0.5pF | GRM1556P1H9R0DZ01# | | |
| | | | | 10pF | ±5% | GRM1556P1H100JZ01# | | |
| 12pF | ±5% | GRM1556P1H120JZ01# | | | | | | |
| 15pF | ±5% | GRM1556P1H150JZ01# | | | | | | |
| 18pF | ±5% | GRM1556P1H180JZ01# | | | | | | |
| 22pF | ±5% | GRM1556P1H220JZ01# | | | | | | |
| 0.55mm | 50Vdc | P2H | 27pF | ±5% | GRM1556P1H270JZ01# | | | |
| | | | | PK | 1.0pF | ±0.25pF | GRM1554P1H1R0CZ01# | |
| | | | 2.0pF | ±0.25pF | GRM1554P1H2R0CZ01# | | | |
| | | | | PJ | 3.0pF | ±0.25pF | GRM1553P1H3R0CZ01# | |
| | | | PH | 4.0pF | ±0.25pF | GRM1552P1H4R0CZ01# | | |
| | | | | 5.0pF | ±0.25pF | GRM1552P1H5R0CZ01# | | |
| | | | | 6.0pF | ±0.5pF | GRM1552P1H6R0DZ01# | | |
| | | | | 7.0pF | ±0.5pF | GRM1552P1H7R0DZ01# | | |
| | | | | 8.0pF | ±0.5pF | GRM1552P1H8R0DZ01# | | |
| | | | | 9.0pF | ±0.5pF | GRM1552P1H9R0DZ01# | | |
| | | | | 10pF | ±5% | GRM1552P1H100JZ01# | | |
| | | | | 12pF | ±5% | GRM1552P1H120JZ01# | | |
| | | | | 15pF | ±5% | GRM1552P1H150JZ01# | | |
| | | | | 18pF | ±5% | GRM1552P1H180JZ01# | | |
| | | | R2H | 22pF | ±5% | GRM1552P1H220JZ01# | | |
| | | | | 27pF | ±5% | GRM1552P1H270JZ01# | | |
| | | | | 1.0pF | ±0.25pF | GRM1556R1H1R0CD01# | | |
| | | | | 2.0pF | ±0.25pF | GRM1556R1H2R0CZ01# | | |
| | | | | 3.0pF | ±0.25pF | GRM1556R1H3R0CZ01# | | |
| | | | | 4.0pF | ±0.25pF | GRM1556R1H4R0CZ01# | | |
| | | | | 5.0pF | ±0.25pF | GRM1556R1H5R0CZ01# | | |
| | | | | 6.0pF | ±0.5pF | GRM1556R1H6R0DZ01# | | |
| | | | | 7.0pF | ±0.5pF | GRM1556R1H7R0DZ01# | | |
| | | | | 8.0pF | ±0.5pF | GRM1556R1H8R0DZ01# | | |
| | | | RK | 9.0pF | ±0.5pF | GRM1556R1H9R0DZ01# | | |
| | | | | 10pF | ±5% | GRM1556R1H100JZ01# | | |
| | | | | 12pF | ±5% | GRM1556R1H120JZ01# | | |
| | | | | 15pF | ±5% | GRM1556R1H150JZ01# | | |
| | | | | 18pF | ±5% | GRM1556R1H180JZ01# | | |
| | | | | 22pF | ±5% | GRM1556R1H220JZ01# | | |
| | | | | 27pF | ±5% | GRM1556R1H270JZ01# | | |
| | | | | 33pF | ±5% | GRM1556R1H330JZ01# | | |
| | | | | RJ | 1.0pF | ±0.25pF | GRM1554R1H1R0CD01# | |
| | | | | | 2.0pF | ±0.25pF | GRM1554R1H2R0CZ01# | |
| | | | RH | 3.0pF | ±0.25pF | GRM1553R1H3R0CZ01# | | |
| | | | RH | 4.0pF | ±0.25pF | GRM1552R1H4R0CZ01# | | |
| 5.0pF | ±0.25pF | GRM1552R1H5R0CZ01# | | | | | | |
| 6.0pF | ±0.5pF | GRM1552R1H6R0DZ01# | | | | | | |
| 7.0pF | ±0.5pF | GRM1552R1H7R0DZ01# | | | | | | |
| 8.0pF | ±0.5pF | GRM1552R1H8R0DZ01# | | | | | | |
| 9.0pF | ±0.5pF | GRM1552R1H9R0DZ01# | | | | | | |
| 10pF | ±5% | GRM1552R1H100JZ01# | | | | | | |
| 12pF | ±5% | GRM1552R1H120JZ01# | | | | | | |
| 15pF | ±5% | GRM1552R1H150JZ01# | | | | | | |
| 18pF | ±5% | GRM1552R1H180JZ01# | | | | | | |
| S2H | 22pF | ±5% | GRM1552R1H220JZ01# | | | | | |
| | 27pF | ±5% | GRM1552R1H270JZ01# | | | | | |
| | 33pF | ±5% | GRM1552R1H330JZ01# | | | | | |
| | 1.0pF | ±0.25pF | GRM1556S1H1R0CD01# | | | | | |
| | 2.0pF | ±0.25pF | GRM1556S1H2R0CZ01# | | | | | |
| | 3.0pF | ±0.25pF | GRM1556S1H3R0CZ01# | | | | | |
| | 4.0pF | ±0.25pF | GRM1556S1H4R0CZ01# | | | | | |
| | 5.0pF | ±0.25pF | GRM1556S1H5R0CZ01# | | | | | |
| | 6.0pF | ±0.5pF | GRM1556S1H6R0DZ01# | | | | | |

Part number # indicates the package specification code.

For General Purpose GRM Series
 Capacitor Array GNM Series
 Low ESL LLI Series
 High-Q Type GJM Series
 High Frequency GQM Series
 Monolithic Microchip GMA Series
 For Bonding GMD Series
 Product Information

GRM Series Temperature Compensating Type Part Number List

(→ ■ 1.0x0.5mm)

| T max. | Rated Voltage | TC Code | Cap. | Tol. | Part Number | T max. | Rated Voltage | TC Code | Cap. | Tol. | Part Number | |
|--------|---------------|---------|-------|--------------------|--------------------|--------|---------------|--------------------|--------------------|--------------------|--------------------|--------------------|
| 0.55mm | 50Vdc | S2H | 7.0pF | ±0.5pF | GRM1556S1H7R0DZ01# | 0.55mm | 50Vdc | TH | 5.0pF | ±0.25pF | GRM1552T1H5R0CD01# | |
| | | | 8.0pF | ±0.5pF | GRM1556S1H8R0DZ01# | | | | 6.0pF | ±0.5pF | GRM1552T1H6R0DD01# | |
| | | | 9.0pF | ±0.5pF | GRM1556S1H9R0DZ01# | | | | 7.0pF | ±0.5pF | GRM1552T1H7R0DD01# | |
| | | | 10pF | ±5% | GRM1556S1H100JZ01# | | | | 8.0pF | ±0.5pF | GRM1552T1H8R0DD01# | |
| | | | 12pF | ±5% | GRM1556S1H120JZ01# | | | | 9.0pF | ±0.5pF | GRM1552T1H9R0DD01# | |
| | | | 15pF | ±5% | GRM1556S1H150JZ01# | | | | 10pF | ±5% | GRM1552T1H100JD01# | |
| | | | 18pF | ±5% | GRM1556S1H180JZ01# | | | | 12pF | ±5% | GRM1552T1H120JD01# | |
| | | | 22pF | ±5% | GRM1556S1H220JZ01# | | | | 15pF | ±5% | GRM1552T1H150JD01# | |
| | | | 27pF | ±5% | GRM1556S1H270JZ01# | | | | 18pF | ±5% | GRM1552T1H180JD01# | |
| | | | 33pF | ±5% | GRM1556S1H330JZ01# | | | | 22pF | ±5% | GRM1552T1H220JD01# | |
| | | 39pF | ±5% | GRM1556S1H390JZ01# | 27pF | | | ±5% | GRM1552T1H270JD01# | | | |
| | | SK | 1.0pF | ±0.25pF | GRM1554S1H1R0CD01# | | | 33pF | ±5% | GRM1552T1H330JD01# | | |
| | | | 2.0pF | ±0.25pF | GRM1554S1H2R0CZ01# | | | 39pF | ±5% | GRM1552T1H390JD01# | | |
| | | SJ | 3.0pF | ±0.25pF | GRM1553S1H3R0CZ01# | | | 47pF | ±5% | GRM1552T1H470JD01# | | |
| | | | SH | 4.0pF | ±0.25pF | | | GRM1552S1H4R0CZ01# | 56pF | ±5% | GRM1552T1H560JD01# | |
| | | 5.0pF | | ±0.25pF | GRM1552S1H5R0CZ01# | | | 68pF | ±5% | GRM1552T1H680JD01# | | |
| | | 6.0pF | | ±0.5pF | GRM1552S1H6R0DZ01# | | | 82pF | ±5% | GRM1552T1H820JD01# | | |
| | | 7.0pF | | ±0.5pF | GRM1552S1H7R0DZ01# | | | 100pF | ±5% | GRM1552T1H101JD01# | | |
| | | 8.0pF | | ±0.5pF | GRM1552S1H8R0DZ01# | | | UK | 1.0pF | ±0.25pF | GRM1554U1H1R0CZ01# | |
| | | 9.0pF | | ±0.5pF | GRM1552S1H9R0DZ01# | | | | 2.0pF | ±0.25pF | GRM1554U1H2R0CZ01# | |
| | | 10pF | | ±5% | GRM1552S1H100JZ01# | | | UU | 3.0pF | ±0.25pF | GRM1553U1H3R0CZ01# | |
| | | 12pF | | ±5% | GRM1552S1H120JZ01# | | | | 4.0pF | ±0.25pF | GRM1553U1H4R0CZ01# | |
| | | 15pF | | ±5% | GRM1552S1H150JZ01# | | | | 5.0pF | ±0.25pF | GRM1553U1H5R0CZ01# | |
| | | 18pF | | ±5% | GRM1552S1H180JZ01# | | | | 6.0pF | ±0.5pF | GRM1553U1H6R0DZ01# | |
| | | 22pF | ±5% | GRM1552S1H220JZ01# | 7.0pF | | | | ±0.5pF | GRM1553U1H7R0DZ01# | | |
| | | 27pF | ±5% | GRM1552S1H270JZ01# | 8.0pF | | | | ±0.5pF | GRM1553U1H8R0DZ01# | | |
| | | 33pF | ±5% | GRM1552S1H330JZ01# | 9.0pF | | | | ±0.5pF | GRM1553U1H9R0DZ01# | | |
| | | 39pF | ±5% | GRM1552S1H390JZ01# | 10pF | | | | ±5% | GRM1553U1H100JZ01# | | |
| | | T2H | 1.0pF | ±0.25pF | GRM1556T1H1R0CD01# | | | | 12pF | ±5% | GRM1553U1H120JZ01# | |
| | | | 2.0pF | ±0.25pF | GRM1556T1H2R0CD01# | | | | 15pF | ±5% | GRM1553U1H150JZ01# | |
| | | | 3.0pF | ±0.25pF | GRM1556T1H3R0CD01# | | | 18pF | ±5% | GRM1553U1H180JZ01# | | |
| | | | 4.0pF | ±0.25pF | GRM1556T1H4R0CD01# | | | 22pF | ±5% | GRM1553U1H220JZ01# | | |
| | | | 5.0pF | ±0.25pF | GRM1556T1H5R0CD01# | | | 27pF | ±5% | GRM1553U1H270JZ01# | | |
| | | | 6.0pF | ±0.5pF | GRM1556T1H6R0DD01# | | | 33pF | ±5% | GRM1553U1H330JZ01# | | |
| | | | 7.0pF | ±0.5pF | GRM1556T1H7R0DD01# | | | 39pF | ±5% | GRM1553U1H390JZ01# | | |
| | | | 8.0pF | ±0.5pF | GRM1556T1H8R0DD01# | | | 47pF | ±5% | GRM1553U1H470JZ01# | | |
| | | | 9.0pF | ±0.5pF | GRM1556T1H9R0DD01# | | | 56pF | ±5% | GRM1553U1H560JZ01# | | |
| | | | 10pF | ±5% | GRM1556T1H100JD01# | | | 68pF | ±5% | GRM1553U1H680JZ01# | | |
| | | 12pF | ±5% | GRM1556T1H120JD01# | 82pF | | | ±5% | GRM1553U1H820JZ01# | | | |
| | | 15pF | ±5% | GRM1556T1H150JD01# | 100pF | | | ±5% | GRM1553U1H101JZ01# | | | |
| | | 18pF | ±5% | GRM1556T1H180JD01# | 120pF | | | ±5% | GRM1553U1H121JZ01# | | | |
| | | 22pF | ±5% | GRM1556T1H220JD01# | 150pF | | | ±5% | GRM1553U1H151JZ01# | | | |
| | | 27pF | ±5% | GRM1556T1H270JD01# | 180pF | | | ±5% | GRM1553U1H181JZ01# | | | |
| | | 33pF | ±5% | GRM1556T1H330JD01# | 10Vdc | | | SL | 1200pF | ±5% | GRM1551X1A122JA01# | |
| | | 39pF | ±5% | GRM1556T1H390JD01# | | | | | 1500pF | ±5% | GRM1551X1A152JA01# | |
| | | 47pF | ±5% | GRM1556T1H470JD01# | | | | | 1800pF | ±5% | GRM1551X1A182JA01# | |
| | | 56pF | ±5% | GRM1556T1H560JD01# | | | | | 2200pF | ±5% | GRM1551X1A222JA01# | |
| | | 68pF | ±5% | GRM1556T1H680JD01# | | | | | 2700pF | ±5% | GRM1551X1A272JA01# | |
| | | 82pF | ±5% | GRM1556T1H820JD01# | | | | | 3300pF | ±5% | GRM1551X1A332JA01# | |
| | | 100pF | ±5% | GRM1556T1H101JD01# | | | | | 3900pF | ±5% | GRM1551X1A392JA01# | |
| | | TK | 1.0pF | ±0.25pF | | | | | GRM1554T1H1R0CD01# | 4700pF | ±5% | GRM1551X1A472JA01# |
| | | | 2.0pF | ±0.25pF | | | | | GRM1554T1H2R0CD01# | U2J | 1200pF | ±5% |
| | | TJ | 3.0pF | ±0.25pF | | | | | GRM1553T1H3R0CD01# | | 1500pF | ±5% |
| | | | TH | 4.0pF | ±0.25pF | | | GRM1552T1H4R0CD01# | 1800pF | | ±5% | GRM1557U1A182JA01# |

Part number # indicates the package specification code.

For General Purpose GRM Series
 Capacitor Array GNM Series
 Low ESL LL□ Series
 High-Q Type GJM Series
 High Frequency GQM Series
 Monolithic Microchip GMA Series
 For Bonding GMD Series
 Product Information

GRM Series Temperature Compensating Type Part Number List

(→ ■ 1.0x0.5mm)

| T max. | Rated Voltage | TC Code | Cap. | Tol. | Part Number |
|--------|---------------|---------|--------|------|--------------------|
| 0.55mm | 10Vdc | U2J | 2200pF | ±5% | GRM1557U1A222JA01# |
| | | | 2700pF | ±5% | GRM1557U1A272JA01# |
| | | | 3300pF | ±5% | GRM1557U1A332JA01# |
| | | | 3900pF | ±5% | GRM1557U1A392JA01# |
| | | | 4700pF | ±5% | GRM1557U1A472JA01# |
| | | UJ | 1200pF | ±5% | GRM1553U1A122JA01# |
| | | | 1500pF | ±5% | GRM1553U1A152JA01# |
| | | | 1800pF | ±5% | GRM1553U1A182JA01# |
| | | | 2200pF | ±5% | GRM1553U1A222JA01# |
| | | | 2700pF | ±5% | GRM1553U1A272JA01# |
| | | | 3300pF | ±5% | GRM1553U1A332JA01# |
| | | | 3900pF | ±5% | GRM1553U1A392JA01# |
| | | | 4700pF | ±5% | GRM1553U1A472JA01# |

| T max. | Rated Voltage | TC Code | Cap. | Tol. | Part Number |
|---------|--------------------|--------------------|-------|---------|--------------------|
| 0.9mm | 100Vdc | C0G | 0.9pF | ±0.1pF | GRM1885C2AR90BA01# |
| | | | 1.0pF | ±0.05pF | GRM1885C2A1R0WA01# |
| | | | | ±0.1pF | GRM1885C2A1R0BA01# |
| | | | | ±0.25pF | GRM1885C2A1R0CA01# |
| | | | 1.1pF | ±0.05pF | GRM1885C2A1R1WA01# |
| | | | | ±0.1pF | GRM1885C2A1R1BA01# |
| | | | | ±0.25pF | GRM1885C2A1R1CA01# |
| | | | 1.2pF | ±0.05pF | GRM1885C2A1R2WA01# |
| | | | | ±0.1pF | GRM1885C2A1R2BA01# |
| | | | | ±0.25pF | GRM1885C2A1R2CA01# |
| | | | 1.3pF | ±0.05pF | GRM1885C2A1R3WA01# |
| | | | | ±0.1pF | GRM1885C2A1R3BA01# |
| | | | | ±0.25pF | GRM1885C2A1R3CA01# |
| | | | 1.4pF | ±0.05pF | GRM1885C2A1R4WA01# |
| | | | | ±0.1pF | GRM1885C2A1R4BA01# |
| | | | | ±0.25pF | GRM1885C2A1R4CA01# |
| | | | 1.5pF | ±0.05pF | GRM1885C2A1R5WA01# |
| | | | | ±0.1pF | GRM1885C2A1R5BA01# |
| | | | | ±0.25pF | GRM1885C2A1R5CA01# |
| | | | 1.6pF | ±0.05pF | GRM1885C2A1R6WA01# |
| | | | | ±0.1pF | GRM1885C2A1R6BA01# |
| | | | | ±0.25pF | GRM1885C2A1R6CA01# |
| | | | 1.7pF | ±0.05pF | GRM1885C2A1R7WA01# |
| | | | | ±0.1pF | GRM1885C2A1R7BA01# |
| | | | | ±0.25pF | GRM1885C2A1R7CA01# |
| | | | 1.8pF | ±0.05pF | GRM1885C2A1R8WA01# |
| | | | | ±0.1pF | GRM1885C2A1R8BA01# |
| | | | | ±0.25pF | GRM1885C2A1R8CA01# |
| | | | 1.9pF | ±0.05pF | GRM1885C2A1R9WA01# |
| | | | | ±0.1pF | GRM1885C2A1R9BA01# |
| | | | | ±0.25pF | GRM1885C2A1R9CA01# |
| | | | 2.0pF | ±0.05pF | GRM1885C2A2R0WA01# |
| | | | | ±0.1pF | GRM1885C2A2R0BA01# |
| | | | | ±0.25pF | GRM1885C2A2R0CA01# |
| | | | 2.1pF | ±0.05pF | GRM1885C2A2R1WA01# |
| | | | | ±0.1pF | GRM1885C2A2R1BA01# |
| | | | | ±0.25pF | GRM1885C2A2R1CA01# |
| | | | 2.2pF | ±0.05pF | GRM1885C2A2R2WA01# |
| | | | | ±0.1pF | GRM1885C2A2R2BA01# |
| | | | | ±0.25pF | GRM1885C2A2R2CA01# |
| | | | 2.3pF | ±0.05pF | GRM1885C2A2R3WA01# |
| | | | | ±0.1pF | GRM1885C2A2R3BA01# |
| ±0.25pF | GRM1885C2A2R3CA01# | | | | |
| 2.4pF | ±0.05pF | GRM1885C2A2R4WA01# | | | |
| | ±0.1pF | GRM1885C2A2R4BA01# | | | |
| | ±0.25pF | GRM1885C2A2R4CA01# | | | |
| 2.5pF | ±0.05pF | GRM1885C2A2R5WA01# | | | |
| | ±0.1pF | GRM1885C2A2R5BA01# | | | |
| | ±0.25pF | GRM1885C2A2R5CA01# | | | |
| 2.6pF | ±0.05pF | GRM1885C2A2R6WA01# | | | |
| | ±0.1pF | GRM1885C2A2R6BA01# | | | |
| | ±0.25pF | GRM1885C2A2R6CA01# | | | |
| 2.7pF | ±0.05pF | GRM1885C2A2R7WA01# | | | |
| | ±0.1pF | GRM1885C2A2R7BA01# | | | |

■ 1.6x0.8mm

| T max. | Rated Voltage | TC Code | Cap. | Tol. | Part Number | | | |
|--------|--------------------|--------------------|---------|---------|--------------------|--------------------|--------------------|--------------------|
| 0.5mm | 50Vdc | SL | 2200pF | ±5% | GRM1851X1H222JA44# | | | |
| | | | 2700pF | ±5% | GRM1851X1H272JA44# | | | |
| | | | 3300pF | ±5% | GRM1851X1H332JA44# | | | |
| | | | 3900pF | ±5% | GRM1851X1H392JA44# | | | |
| | | | 4700pF | ±5% | GRM1851X1H472JA44# | | | |
| | | U2J | 2200pF | ±5% | GRM1857U1H222JA44# | | | |
| | | | 2700pF | ±5% | GRM1857U1H272JA44# | | | |
| | | | 3300pF | ±5% | GRM1857U1H332JA44# | | | |
| | | | 3900pF | ±5% | GRM1857U1H392JA44# | | | |
| | | | 4700pF | ±5% | GRM1857U1H472JA44# | | | |
| | | UJ | 2200pF | ±5% | GRM1853U1H222JA44# | | | |
| | | | 2700pF | ±5% | GRM1853U1H272JA44# | | | |
| | | | 3300pF | ±5% | GRM1853U1H332JA44# | | | |
| | | | 3900pF | ±5% | GRM1853U1H392JA44# | | | |
| | | | 4700pF | ±5% | GRM1853U1H472JA44# | | | |
| | | 10Vdc | SL | 5600pF | ±5% | GRM1851X1A562JA44# | | |
| | | | | 6800pF | ±5% | GRM1851X1A682JA44# | | |
| | | | | 8200pF | ±5% | GRM1851X1A822JA44# | | |
| | | | | 10000pF | ±5% | GRM1851X1A103JA44# | | |
| | | | | U2J | 5600pF | ±5% | GRM1857U1A562JA44# | |
| | | | 6800pF | | ±5% | GRM1857U1A682JA44# | | |
| | | | 8200pF | | ±5% | GRM1857U1A822JA44# | | |
| | | | 10000pF | | ±5% | GRM1857U1A103JA44# | | |
| | | | UJ | | 5600pF | ±5% | GRM1853U1A562JA44# | |
| | | | | 6800pF | ±5% | GRM1853U1A682JA44# | | |
| | | | | 8200pF | ±5% | GRM1853U1A822JA44# | | |
| | | | | 10000pF | ±5% | GRM1853U1A103JA44# | | |
| | | | | 0.9mm | 100Vdc | C0G | 0.5pF | ±0.05pF |
| | | | ±0.1pF | | | | | GRM1885C2AR50BA01# |
| | | | 0.6pF | | | | ±0.05pF | GRM1885C2AR60WA01# |
| ±0.1pF | GRM1885C2AR60BA01# | | | | | | | |
| 0.7pF | ±0.05pF | GRM1885C2AR70WA01# | | | | | | |
| | ±0.1pF | GRM1885C2AR70BA01# | | | | | | |
| 0.8pF | ±0.05pF | GRM1885C2AR80WA01# | | | | | | |
| | ±0.1pF | GRM1885C2AR80BA01# | | | | | | |
| 0.9pF | ±0.05pF | GRM1885C2AR90WA01# | | | | | | |

Part number # indicates the package specification code.

For General Purpose GRM Series
 Capacitor Array GNM Series
 Low ESL LLI Series
 High-Q Type GJM Series
 High Frequency GQM Series
 Monolithic Microchip GMA Series
 For Bonding GMD Series
 Product Information

GRM Series Temperature Compensating Type Part Number List

(→ ■ 1.6x0.8mm)

| T max. | Rated Voltage | TC Code | Cap. | Tol. | Part Number | |
|--------|---------------|---------|---------|--------------------|--------------------|--------------------|
| 0.9mm | 100Vdc | C0G | 2.7pF | ±0.25pF | GRM1885C2A2R7CA01# | |
| | | | | ±0.05pF | GRM1885C2A2R8WA01# | |
| | | | | | ±0.1pF | GRM1885C2A2R8BA01# |
| | | | ±0.25pF | GRM1885C2A2R8CA01# | | |
| | | | | 2.9pF | ±0.05pF | GRM1885C2A2R9WA01# |
| | | | | | ±0.1pF | GRM1885C2A2R9BA01# |
| | | | ±0.25pF | | GRM1885C2A2R9CA01# | |
| | | | 3.0pF | ±0.05pF | GRM1885C2A3R0WA01# | |
| | | | | ±0.1pF | GRM1885C2A3R0BA01# | |
| | | | | ±0.25pF | GRM1885C2A3R0CA01# | |
| | | | 3.1pF | ±0.05pF | GRM1885C2A3R1WA01# | |
| | | | | ±0.1pF | GRM1885C2A3R1BA01# | |
| | | | | ±0.25pF | GRM1885C2A3R1CA01# | |
| | | | 3.2pF | ±0.05pF | GRM1885C2A3R2WA01# | |
| | | | | ±0.1pF | GRM1885C2A3R2BA01# | |
| | | | | ±0.25pF | GRM1885C2A3R2CA01# | |
| | | | 3.3pF | ±0.05pF | GRM1885C2A3R3WA01# | |
| | | | | ±0.1pF | GRM1885C2A3R3BA01# | |
| | | | | ±0.25pF | GRM1885C2A3R3CA01# | |
| | | | 3.4pF | ±0.05pF | GRM1885C2A3R4WA01# | |
| | | | | ±0.1pF | GRM1885C2A3R4BA01# | |
| | | | | ±0.25pF | GRM1885C2A3R4CA01# | |
| | | | 3.5pF | ±0.05pF | GRM1885C2A3R5WA01# | |
| | | | | ±0.1pF | GRM1885C2A3R5BA01# | |
| | | | | ±0.25pF | GRM1885C2A3R5CA01# | |
| | | | 3.6pF | ±0.05pF | GRM1885C2A3R6WA01# | |
| | | | | ±0.1pF | GRM1885C2A3R6BA01# | |
| | | | | ±0.25pF | GRM1885C2A3R6CA01# | |
| | | | 3.7pF | ±0.05pF | GRM1885C2A3R7WA01# | |
| | | | | ±0.1pF | GRM1885C2A3R7BA01# | |
| | | | | ±0.25pF | GRM1885C2A3R7CA01# | |
| | | | 3.8pF | ±0.05pF | GRM1885C2A3R8WA01# | |
| | | | | ±0.1pF | GRM1885C2A3R8BA01# | |
| | | | | ±0.25pF | GRM1885C2A3R8CA01# | |
| | | | 3.9pF | ±0.05pF | GRM1885C2A3R9WA01# | |
| | | | | ±0.1pF | GRM1885C2A3R9BA01# | |
| | | | | ±0.25pF | GRM1885C2A3R9CA01# | |
| | | | 4.0pF | ±0.05pF | GRM1885C2A4R0WA01# | |
| | | | | ±0.1pF | GRM1885C2A4R0BA01# | |
| | | | | ±0.25pF | GRM1885C2A4R0CA01# | |
| | | | 4.1pF | ±0.05pF | GRM1885C2A4R1WA01# | |
| | | | | ±0.1pF | GRM1885C2A4R1BA01# | |
| | | | | ±0.25pF | GRM1885C2A4R1CA01# | |
| | | | 4.2pF | ±0.05pF | GRM1885C2A4R2WA01# | |
| | | | | ±0.1pF | GRM1885C2A4R2BA01# | |
| | | | | ±0.25pF | GRM1885C2A4R2CA01# | |
| | | | 4.3pF | ±0.05pF | GRM1885C2A4R3WA01# | |
| | | | | ±0.1pF | GRM1885C2A4R3BA01# | |
| | | | | ±0.25pF | GRM1885C2A4R3CA01# | |
| | | | 4.4pF | ±0.05pF | GRM1885C2A4R4WA01# | |
| | | | | ±0.1pF | GRM1885C2A4R4BA01# | |
| | | | | ±0.25pF | GRM1885C2A4R4CA01# | |
| | | | 4.5pF | ±0.05pF | GRM1885C2A4R5WA01# | |
| | | | | ±0.1pF | GRM1885C2A4R5BA01# | |

| T max. | Rated Voltage | TC Code | Cap. | Tol. | Part Number | |
|--------|---------------|---------|---------|--------------------|--------------------|--------------------|
| 0.9mm | 100Vdc | C0G | 4.5pF | ±0.25pF | GRM1885C2A4R5CA01# | |
| | | | | ±0.05pF | GRM1885C2A4R6WA01# | |
| | | | | | ±0.1pF | GRM1885C2A4R6BA01# |
| | | | ±0.25pF | GRM1885C2A4R6CA01# | | |
| | | | | 4.7pF | ±0.05pF | GRM1885C2A4R7WA01# |
| | | | | | ±0.1pF | GRM1885C2A4R7BA01# |
| | | | ±0.25pF | | GRM1885C2A4R7CA01# | |
| | | | 4.8pF | ±0.05pF | GRM1885C2A4R8WA01# | |
| | | | | ±0.1pF | GRM1885C2A4R8BA01# | |
| | | | | ±0.25pF | GRM1885C2A4R8CA01# | |
| | | | 4.9pF | ±0.05pF | GRM1885C2A4R9WA01# | |
| | | | | ±0.1pF | GRM1885C2A4R9BA01# | |
| | | | | ±0.25pF | GRM1885C2A4R9CA01# | |
| | | | 5.0pF | ±0.05pF | GRM1885C2A5R0WA01# | |
| | | | | ±0.1pF | GRM1885C2A5R0BA01# | |
| | | | | ±0.25pF | GRM1885C2A5R0CA01# | |
| | | | 5.1pF | ±0.05pF | GRM1885C2A5R1WA01# | |
| | | | | ±0.1pF | GRM1885C2A5R1BA01# | |
| | | | | ±0.25pF | GRM1885C2A5R1CA01# | |
| | | | ±0.5pF | GRM1885C2A5R1DA01# | | |
| | | | | 5.2pF | ±0.05pF | GRM1885C2A5R2WA01# |
| | | | | | ±0.1pF | GRM1885C2A5R2BA01# |
| | | | ±0.25pF | | GRM1885C2A5R2CA01# | |
| | | | ±0.5pF | GRM1885C2A5R2DA01# | | |
| | | | | 5.3pF | ±0.05pF | GRM1885C2A5R3WA01# |
| | | | | | ±0.1pF | GRM1885C2A5R3BA01# |
| | | | ±0.25pF | | GRM1885C2A5R3CA01# | |
| | | | ±0.5pF | GRM1885C2A5R3DA01# | | |
| | | | | 5.4pF | ±0.05pF | GRM1885C2A5R4WA01# |
| | | | | | ±0.1pF | GRM1885C2A5R4BA01# |
| | | | ±0.25pF | | GRM1885C2A5R4CA01# | |
| | | | ±0.5pF | GRM1885C2A5R4DA01# | | |
| | | | | 5.5pF | ±0.05pF | GRM1885C2A5R5WA01# |
| | | | | | ±0.1pF | GRM1885C2A5R5BA01# |
| | | | ±0.25pF | | GRM1885C2A5R5CA01# | |
| | | | ±0.5pF | GRM1885C2A5R5DA01# | | |
| | | | | 5.6pF | ±0.05pF | GRM1885C2A5R6WA01# |
| | | | | | ±0.1pF | GRM1885C2A5R6BA01# |
| | | | ±0.25pF | | GRM1885C2A5R6CA01# | |
| | | | ±0.5pF | GRM1885C2A5R6DA01# | | |
| | | | | 5.7pF | ±0.05pF | GRM1885C2A5R7WA01# |
| | | | | | ±0.1pF | GRM1885C2A5R7BA01# |
| | | | ±0.25pF | | GRM1885C2A5R7CA01# | |
| | | | ±0.5pF | GRM1885C2A5R7DA01# | | |
| | | | | 5.8pF | ±0.05pF | GRM1885C2A5R8WA01# |
| | | | | | ±0.1pF | GRM1885C2A5R8BA01# |
| | | | ±0.25pF | | GRM1885C2A5R8CA01# | |
| | | | ±0.5pF | GRM1885C2A5R8DA01# | | |
| | | | | 5.9pF | ±0.05pF | GRM1885C2A5R9WA01# |
| | | | | | ±0.1pF | GRM1885C2A5R9BA01# |
| | | | ±0.25pF | | GRM1885C2A5R9CA01# | |
| | | | ±0.5pF | GRM1885C2A5R9DA01# | | |
| | | | | 6.0pF | ±0.05pF | GRM1885C2A6R0WA01# |
| | | | | | ±0.1pF | GRM1885C2A6R0BA01# |

Part number # indicates the package specification code.

GRM Series Temperature Compensating Type Part Number List

(→ ■ 1.6x0.8mm)

| T max. | Rated Voltage | TC Code | Cap. | Tol. | Part Number |
|--------|---------------|---------|-------|---------|--------------------|
| 0.9mm | 100Vdc | C0G | 6.0pF | ±0.25pF | GRM1885C2A6R0CA01# |
| | | | | ±0.5pF | GRM1885C2A6R0DA01# |
| | | | 6.1pF | ±0.05pF | GRM1885C2A6R1WA01# |
| | | | | ±0.1pF | GRM1885C2A6R1BA01# |
| | | | | ±0.25pF | GRM1885C2A6R1CA01# |
| | | | | ±0.5pF | GRM1885C2A6R1DA01# |
| | | | 6.2pF | ±0.05pF | GRM1885C2A6R2WA01# |
| | | | | ±0.1pF | GRM1885C2A6R2BA01# |
| | | | | ±0.25pF | GRM1885C2A6R2CA01# |
| | | | | ±0.5pF | GRM1885C2A6R2DA01# |
| | | | 6.3pF | ±0.05pF | GRM1885C2A6R3WA01# |
| | | | | ±0.1pF | GRM1885C2A6R3BA01# |
| | | | | ±0.25pF | GRM1885C2A6R3CA01# |
| | | | | ±0.5pF | GRM1885C2A6R3DA01# |
| | | | 6.4pF | ±0.05pF | GRM1885C2A6R4WA01# |
| | | | | ±0.1pF | GRM1885C2A6R4BA01# |
| | | | | ±0.25pF | GRM1885C2A6R4CA01# |
| | | | | ±0.5pF | GRM1885C2A6R4DA01# |
| | | | 6.5pF | ±0.05pF | GRM1885C2A6R5WA01# |
| | | | | ±0.1pF | GRM1885C2A6R5BA01# |
| | | | | ±0.25pF | GRM1885C2A6R5CA01# |
| | | | | ±0.5pF | GRM1885C2A6R5DA01# |
| | | | 6.6pF | ±0.05pF | GRM1885C2A6R6WA01# |
| | | | | ±0.1pF | GRM1885C2A6R6BA01# |
| | | | | ±0.25pF | GRM1885C2A6R6CA01# |
| | | | | ±0.5pF | GRM1885C2A6R6DA01# |
| | | | 6.7pF | ±0.05pF | GRM1885C2A6R7WA01# |
| | | | | ±0.1pF | GRM1885C2A6R7BA01# |
| | | | | ±0.25pF | GRM1885C2A6R7CA01# |
| | | | | ±0.5pF | GRM1885C2A6R7DA01# |
| | | | 6.8pF | ±0.05pF | GRM1885C2A6R8WA01# |
| | | | | ±0.1pF | GRM1885C2A6R8BA01# |
| | | | | ±0.25pF | GRM1885C2A6R8CA01# |
| | | | | ±0.5pF | GRM1885C2A6R8DA01# |
| | | | 6.9pF | ±0.05pF | GRM1885C2A6R9WA01# |
| | | | | ±0.1pF | GRM1885C2A6R9BA01# |
| | | | | ±0.25pF | GRM1885C2A6R9CA01# |
| | | | | ±0.5pF | GRM1885C2A6R9DA01# |
| | | | 7.0pF | ±0.05pF | GRM1885C2A7R0WA01# |
| | | | | ±0.1pF | GRM1885C2A7R0BA01# |
| | | | | ±0.25pF | GRM1885C2A7R0CA01# |
| | | | | ±0.5pF | GRM1885C2A7R0DA01# |
| | | | 7.1pF | ±0.05pF | GRM1885C2A7R1WA01# |
| | | | | ±0.1pF | GRM1885C2A7R1BA01# |
| | | | | ±0.25pF | GRM1885C2A7R1CA01# |
| | | | | ±0.5pF | GRM1885C2A7R1DA01# |
| | | | 7.2pF | ±0.05pF | GRM1885C2A7R2WA01# |
| | | | | ±0.1pF | GRM1885C2A7R2BA01# |
| | | | | ±0.25pF | GRM1885C2A7R2CA01# |
| | | | | ±0.5pF | GRM1885C2A7R2DA01# |
| | | | 7.3pF | ±0.05pF | GRM1885C2A7R3WA01# |
| | | | | ±0.1pF | GRM1885C2A7R3BA01# |
| | | | | ±0.25pF | GRM1885C2A7R3CA01# |
| | | | | ±0.5pF | GRM1885C2A7R3DA01# |

| T max. | Rated Voltage | TC Code | Cap. | Tol. | Part Number |
|--------|---------------|---------|-------|---------|--------------------|
| 0.9mm | 100Vdc | C0G | 7.4pF | ±0.05pF | GRM1885C2A7R4WA01# |
| | | | | ±0.1pF | GRM1885C2A7R4BA01# |
| | | | | ±0.25pF | GRM1885C2A7R4CA01# |
| | | | | ±0.5pF | GRM1885C2A7R4DA01# |
| | | | 7.5pF | ±0.05pF | GRM1885C2A7R5WA01# |
| | | | | ±0.1pF | GRM1885C2A7R5BA01# |
| | | | | ±0.25pF | GRM1885C2A7R5CA01# |
| | | | 7.6pF | ±0.05pF | GRM1885C2A7R6WA01# |
| | | | | ±0.1pF | GRM1885C2A7R6BA01# |
| | | | | ±0.25pF | GRM1885C2A7R6CA01# |
| | | | 7.7pF | ±0.05pF | GRM1885C2A7R7WA01# |
| | | | | ±0.1pF | GRM1885C2A7R7BA01# |
| | | | | ±0.25pF | GRM1885C2A7R7CA01# |
| | | | 7.8pF | ±0.05pF | GRM1885C2A7R8WA01# |
| | | | | ±0.1pF | GRM1885C2A7R8BA01# |
| | | | | ±0.25pF | GRM1885C2A7R8CA01# |
| | | | 7.9pF | ±0.05pF | GRM1885C2A7R9WA01# |
| | | | | ±0.1pF | GRM1885C2A7R9BA01# |
| | | | | ±0.25pF | GRM1885C2A7R9CA01# |
| | | | 8.0pF | ±0.05pF | GRM1885C2A8R0WA01# |
| | | | | ±0.1pF | GRM1885C2A8R0BA01# |
| | | | | ±0.25pF | GRM1885C2A8R0CA01# |
| | | | 8.1pF | ±0.05pF | GRM1885C2A8R1WA01# |
| | | | | ±0.1pF | GRM1885C2A8R1BA01# |
| | | | | ±0.25pF | GRM1885C2A8R1CA01# |
| | | | 8.2pF | ±0.05pF | GRM1885C2A8R2WA01# |
| | | | | ±0.1pF | GRM1885C2A8R2BA01# |
| | | | | ±0.25pF | GRM1885C2A8R2CA01# |
| | | | 8.3pF | ±0.05pF | GRM1885C2A8R3WA01# |
| | | | | ±0.1pF | GRM1885C2A8R3BA01# |
| | | | | ±0.25pF | GRM1885C2A8R3CA01# |
| | | | 8.4pF | ±0.05pF | GRM1885C2A8R4WA01# |
| | | | | ±0.1pF | GRM1885C2A8R4BA01# |
| | | | | ±0.25pF | GRM1885C2A8R4CA01# |
| | | | 8.5pF | ±0.05pF | GRM1885C2A8R5WA01# |
| | | | | ±0.1pF | GRM1885C2A8R5BA01# |
| | | | | ±0.25pF | GRM1885C2A8R5CA01# |
| | | | 8.6pF | ±0.05pF | GRM1885C2A8R6WA01# |
| | | | | ±0.1pF | GRM1885C2A8R6BA01# |
| | | | | ±0.25pF | GRM1885C2A8R6CA01# |
| | | | 8.7pF | ±0.05pF | GRM1885C2A8R7WA01# |
| | | | | ±0.1pF | GRM1885C2A8R7BA01# |

Part number # indicates the package specification code.

For General Purpose GRM Series
 Capacitor Array GNM Series
 Low ESL LL Series
 High-Q Type GJM Series
 High Frequency GQM Series
 Monolithic Microchip GMA Series
 For Bonding GMD Series
 Product Information

GRM Series Temperature Compensating Type Part Number List

(→ ■ 1.6x0.8mm)

| T max. | Rated Voltage | TC Code | Cap. | Tol. | Part Number | | T max. | Rated Voltage | TC Code | Cap. | Tol. | Part Number | | | |
|--------|---------------|---------|---------|---------|--------------------|--------------------|--------|---------------|---------|--------------------|--------------------|--------------------|--------------------|--------------------|--------------------|
| 0.9mm | 100Vdc | C0G | 8.7pF | ±0.25pF | GRM1885C2A8R7CA01# | | 0.9mm | 100Vdc | C0G | 22pF | ±5% | GRM1885C2A220JA01# | | | |
| | | | | ±0.5pF | GRM1885C2A8R7DA01# | | | | | | 27pF | ±5% | GRM1885C2A270JA01# | | |
| | | | 8.8pF | ±0.05pF | GRM1885C2A8R8WA01# | | | | | 33pF | | ±5% | GRM1885C2A330JA01# | | |
| | | | | ±0.1pF | GRM1885C2A8R8BA01# | | | | | | 39pF | ±5% | GRM1885C2A390JA01# | | |
| | | | | ±0.25pF | GRM1885C2A8R8CA01# | | | | | 47pF | | ±5% | GRM1885C2A470JA01# | | |
| | | | | ±0.5pF | GRM1885C2A8R8DA01# | | | | | | | 56pF | ±5% | GRM1885C2A560JA01# | |
| | | | | 8.9pF | ±0.05pF | GRM1885C2A8R9WA01# | | | | | 68pF | | ±5% | GRM1885C2A680JA01# | |
| | | | ±0.1pF | | GRM1885C2A8R9BA01# | | | | | 82pF | | | ±5% | GRM1885C2A820JA01# | |
| | | | ±0.25pF | | GRM1885C2A8R9CA01# | | | | | | 100pF | | ±5% | GRM1885C2A101JA01# | |
| | | | ±0.5pF | | GRM1885C2A8R9DA01# | | | | | | | | 120pF | ±5% | GRM1885C2A121JA01# |
| | | | 9.0pF | ±0.05pF | GRM1885C2A9R0WA01# | | | | | 150pF | ±5% | GRM1885C2A151JA01# | | | |
| | | | | ±0.1pF | GRM1885C2A9R0BA01# | | | | | | 180pF | ±5% | | GRM1885C2A181JA01# | |
| | | | | ±0.25pF | GRM1885C2A9R0CA01# | | | | | 220pF | | ±5% | | GRM1885C2A221JA01# | |
| | | | | ±0.5pF | GRM1885C2A9R0DA01# | | | | | | | 270pF | | ±5% | GRM1885C2A271JA01# |
| | | | 9.1pF | ±0.05pF | GRM1885C2A9R1WA01# | | | | | 330pF | ±5% | | GRM1885C2A331JA01# | | |
| | | | | ±0.1pF | GRM1885C2A9R1BA01# | | | | | | 390pF | | ±5% | GRM1885C2A391JA01# | |
| | | | | ±0.25pF | GRM1885C2A9R1CA01# | | | | | 470pF | | | ±5% | GRM1885C2A471JA01# | |
| | | | | ±0.5pF | GRM1885C2A9R1DA01# | | | | | | | | 560pF | ±5% | GRM1885C2A561JA01# |
| | | | 9.2pF | ±0.05pF | GRM1885C2A9R2WA01# | | | | | 680pF | ±5% | GRM1885C2A681JA01# | | | |
| | | | | ±0.1pF | GRM1885C2A9R2BA01# | | | | | | 820pF | ±5% | | GRM1885C2A821JA01# | |
| | | | | ±0.25pF | GRM1885C2A9R2CA01# | | | | | 1000pF | | ±5% | | GRM1885C2A102JA01# | |
| | | | | ±0.5pF | GRM1885C2A9R2DA01# | | | | | | | 1200pF | | ±5% | GRM1885C2A122JA01# |
| | | | 9.3pF | ±0.05pF | GRM1885C2A9R3WA01# | | | | | 1500pF | ±5% | | GRM1885C2A152JA01# | | |
| | | | | ±0.1pF | GRM1885C2A9R3BA01# | | | | | | 0.5pF | | ±0.05pF | GRM1884C2AR50WA01# | |
| | | | | ±0.25pF | GRM1885C2A9R3CA01# | | | | | ±0.1pF | | | GRM1884C2AR50BA01# | | |
| | | | | ±0.5pF | GRM1885C2A9R3DA01# | | | | | | | | 0.6pF | ±0.05pF | GRM1884C2AR60WA01# |
| | | | 9.4pF | ±0.05pF | GRM1885C2A9R4WA01# | | | | | ±0.1pF | GRM1884C2AR60BA01# | | | | |
| | | | | ±0.1pF | GRM1885C2A9R4BA01# | | | | | | 0.7pF | ±0.05pF | | GRM1884C2AR70WA01# | |
| | | | | ±0.25pF | GRM1885C2A9R4CA01# | | | | | ±0.1pF | | GRM1884C2AR70BA01# | | | |
| | | | | ±0.5pF | GRM1885C2A9R4DA01# | | | | | | | 0.8pF | | ±0.05pF | GRM1884C2AR80WA01# |
| | | | 9.5pF | ±0.05pF | GRM1885C2A9R5WA01# | | | | | ±0.1pF | GRM1884C2AR80BA01# | | | | |
| | | | | ±0.1pF | GRM1885C2A9R5BA01# | | | | | | 0.9pF | | ±0.05pF | GRM1884C2AR90WA01# | |
| | | | | ±0.25pF | GRM1885C2A9R5CA01# | | | | | ±0.1pF | | | GRM1884C2AR90BA01# | | |
| | | | | ±0.5pF | GRM1885C2A9R5DA01# | | | | | | | | 1.0pF | ±0.05pF | GRM1884C2A1R0WA01# |
| | | | 9.6pF | ±0.05pF | GRM1885C2A9R6WA01# | | | | | ±0.1pF | GRM1884C2A1R0BA01# | | | | |
| | | | | ±0.1pF | GRM1885C2A9R6BA01# | | | | | | ±0.25pF | GRM1884C2A1R0CA01# | | | |
| | | | | ±0.25pF | GRM1885C2A9R6CA01# | | | | | 1.1pF | | ±0.05pF | | GRM1884C2A1R1WA01# | |
| | | | | ±0.5pF | GRM1885C2A9R6DA01# | | | | | | | ±0.1pF | | GRM1884C2A1R1BA01# | |
| | | | 9.7pF | ±0.05pF | GRM1885C2A9R7WA01# | | | | | ±0.25pF | GRM1884C2A1R1CA01# | | | | |
| | | | | ±0.1pF | GRM1885C2A9R7BA01# | | | | | | 1.2pF | | ±0.05pF | GRM1884C2A1R2WA01# | |
| | | | | ±0.25pF | GRM1885C2A9R7CA01# | | | | | ±0.1pF | | GRM1884C2A1R2BA01# | | | |
| | | | | ±0.5pF | GRM1885C2A9R7DA01# | | | | | | | ±0.25pF | GRM1884C2A1R2CA01# | | |
| | | | 9.8pF | ±0.05pF | GRM1885C2A9R8WA01# | | | | | 1.3pF | ±0.05pF | | GRM1884C2A1R3WA01# | | |
| | | | | ±0.1pF | GRM1885C2A9R8BA01# | | | | | | ±0.1pF | | GRM1884C2A1R3BA01# | | |
| | | | | ±0.25pF | GRM1885C2A9R8CA01# | | | | | | | | ±0.25pF | GRM1884C2A1R3CA01# | |
| | | | | ±0.5pF | GRM1885C2A9R8DA01# | | | | | 1.4pF | ±0.05pF | | | GRM1884C2A1R4WA01# | |
| | | | 9.9pF | ±0.05pF | GRM1885C2A9R9WA01# | | | | | | ±0.1pF | GRM1884C2A1R4BA01# | | | |
| | | | | ±0.1pF | GRM1885C2A9R9BA01# | | | | | | | ±0.25pF | GRM1884C2A1R4CA01# | | |
| | | | | ±0.25pF | GRM1885C2A9R9CA01# | | | | | | | | 1.5pF | ±0.05pF | GRM1884C2A1R5WA01# |
| | | | | ±0.5pF | GRM1885C2A9R9DA01# | | | | | | ±0.1pF | GRM1884C2A1R5BA01# | | | |
| | | | 10pF | ±5% | GRM1885C2A100JA01# | | | | | ±0.25pF | | GRM1884C2A1R5CA01# | | | |
| | | | | 12pF | ±5% | GRM1885C2A120JA01# | | | | | | | 1.6pF | ±0.05pF | GRM1884C2A1R6WA01# |
| | | | | | 15pF | ±5% | | | | GRM1885C2A150JA01# | | ±0.1pF | | GRM1884C2A1R6BA01# | |
| | | | ±5% | | | GRM1885C2A180JA01# | | | | | ±0.25pF | | | GRM1884C2A1R6CA01# | |

Part number # indicates the package specification code.

GRM Series Temperature Compensating Type Part Number List

(→ ■ 1.6x0.8mm)

| T max. | Rated Voltage | TC Code | Cap. | Tol. | Part Number | |
|--------|---------------|--------------------|---------|--------------------|--------------------|--------------------|
| 0.9mm | 100Vdc | CK | 1.7pF | ±0.05pF | GRM1884C2A1R7WA01# | |
| | | | | ±0.1pF | GRM1884C2A1R7BA01# | |
| | | | | ±0.25pF | GRM1884C2A1R7CA01# | |
| | | | 1.8pF | ±0.05pF | GRM1884C2A1R8WA01# | |
| | | | | ±0.1pF | GRM1884C2A1R8BA01# | |
| | | | | ±0.25pF | GRM1884C2A1R8CA01# | |
| | | | 1.9pF | ±0.05pF | GRM1884C2A1R9WA01# | |
| | | | | ±0.1pF | GRM1884C2A1R9BA01# | |
| | | | | ±0.25pF | GRM1884C2A1R9CA01# | |
| | | | 2.0pF | ±0.05pF | GRM1884C2A2R0WA01# | |
| | | | | ±0.1pF | GRM1884C2A2R0BA01# | |
| | | | | ±0.25pF | GRM1884C2A2R0CA01# | |
| | | | CJ | 2.1pF | ±0.05pF | GRM1883C2A2R1WA01# |
| | | | | | ±0.1pF | GRM1883C2A2R1BA01# |
| | | | | | ±0.25pF | GRM1883C2A2R1CA01# |
| | | | | 2.2pF | ±0.05pF | GRM1883C2A2R2WA01# |
| | | | | | ±0.1pF | GRM1883C2A2R2BA01# |
| | | | | | ±0.25pF | GRM1883C2A2R2CA01# |
| | | | | 2.3pF | ±0.05pF | GRM1883C2A2R3WA01# |
| | | | | | ±0.1pF | GRM1883C2A2R3BA01# |
| | | | | | ±0.25pF | GRM1883C2A2R3CA01# |
| | | | | 2.4pF | ±0.05pF | GRM1883C2A2R4WA01# |
| | | | | | ±0.1pF | GRM1883C2A2R4BA01# |
| | | | | | ±0.25pF | GRM1883C2A2R4CA01# |
| | | 2.5pF | | ±0.05pF | GRM1883C2A2R5WA01# | |
| | | | | ±0.1pF | GRM1883C2A2R5BA01# | |
| | | | | ±0.25pF | GRM1883C2A2R5CA01# | |
| | | 2.6pF | | ±0.05pF | GRM1883C2A2R6WA01# | |
| | | | | ±0.1pF | GRM1883C2A2R6BA01# | |
| | | | | ±0.25pF | GRM1883C2A2R6CA01# | |
| | | 2.7pF | | ±0.05pF | GRM1883C2A2R7WA01# | |
| | | | | ±0.1pF | GRM1883C2A2R7BA01# | |
| | | | | ±0.25pF | GRM1883C2A2R7CA01# | |
| | | 2.8pF | | ±0.05pF | GRM1883C2A2R8WA01# | |
| | | | | ±0.1pF | GRM1883C2A2R8BA01# | |
| | | | | ±0.25pF | GRM1883C2A2R8CA01# | |
| | | 2.9pF | ±0.05pF | GRM1883C2A2R9WA01# | | |
| | | | ±0.1pF | GRM1883C2A2R9BA01# | | |
| | | | ±0.25pF | GRM1883C2A2R9CA01# | | |
| | | 3.0pF | ±0.05pF | GRM1883C2A3R0WA01# | | |
| | | | ±0.1pF | GRM1883C2A3R0BA01# | | |
| | | | ±0.25pF | GRM1883C2A3R0CA01# | | |
| | | 3.1pF | ±0.05pF | GRM1883C2A3R1WA01# | | |
| | | | ±0.1pF | GRM1883C2A3R1BA01# | | |
| | | | ±0.25pF | GRM1883C2A3R1CA01# | | |
| | | 3.2pF | ±0.05pF | GRM1883C2A3R2WA01# | | |
| | | | ±0.1pF | GRM1883C2A3R2BA01# | | |
| | | | ±0.25pF | GRM1883C2A3R2CA01# | | |
| 3.3pF | ±0.05pF | GRM1883C2A3R3WA01# | | | | |
| | ±0.1pF | GRM1883C2A3R3BA01# | | | | |
| | ±0.25pF | GRM1883C2A3R3CA01# | | | | |
| 3.4pF | ±0.05pF | GRM1883C2A3R4WA01# | | | | |
| | ±0.1pF | GRM1883C2A3R4BA01# | | | | |
| | ±0.25pF | GRM1883C2A3R4CA01# | | | | |

| T max. | Rated Voltage | TC Code | Cap. | Tol. | Part Number | |
|--------|---------------|--------------------|---------|--------------------|--------------------|--------------------|
| 0.9mm | 100Vdc | CJ | 3.5pF | ±0.05pF | GRM1883C2A3R5WA01# | |
| | | | | ±0.1pF | GRM1883C2A3R5BA01# | |
| | | | | ±0.25pF | GRM1883C2A3R5CA01# | |
| | | | 3.6pF | ±0.05pF | GRM1883C2A3R6WA01# | |
| | | | | ±0.1pF | GRM1883C2A3R6BA01# | |
| | | | | ±0.25pF | GRM1883C2A3R6CA01# | |
| | | | 3.7pF | ±0.05pF | GRM1883C2A3R7WA01# | |
| | | | | ±0.1pF | GRM1883C2A3R7BA01# | |
| | | | | ±0.25pF | GRM1883C2A3R7CA01# | |
| | | | 3.8pF | ±0.05pF | GRM1883C2A3R8WA01# | |
| | | | | ±0.1pF | GRM1883C2A3R8BA01# | |
| | | | | ±0.25pF | GRM1883C2A3R8CA01# | |
| | | | 3.9pF | ±0.05pF | GRM1883C2A3R9WA01# | |
| | | | | ±0.1pF | GRM1883C2A3R9BA01# | |
| | | | | ±0.25pF | GRM1883C2A3R9CA01# | |
| | | | CH | 4.0pF | ±0.05pF | GRM1882C2A4R0WA01# |
| | | | | | ±0.1pF | GRM1882C2A4R0BA01# |
| | | | | | ±0.25pF | GRM1882C2A4R0CA01# |
| | | | | 4.1pF | ±0.05pF | GRM1882C2A4R1WA01# |
| | | | | | ±0.1pF | GRM1882C2A4R1BA01# |
| | | | | | ±0.25pF | GRM1882C2A4R1CA01# |
| | | | | 4.2pF | ±0.05pF | GRM1882C2A4R2WA01# |
| | | | | | ±0.1pF | GRM1882C2A4R2BA01# |
| | | | | | ±0.25pF | GRM1882C2A4R2CA01# |
| | | 4.3pF | | ±0.05pF | GRM1882C2A4R3WA01# | |
| | | | | ±0.1pF | GRM1882C2A4R3BA01# | |
| | | | | ±0.25pF | GRM1882C2A4R3CA01# | |
| | | 4.4pF | | ±0.05pF | GRM1882C2A4R4WA01# | |
| | | | | ±0.1pF | GRM1882C2A4R4BA01# | |
| | | | | ±0.25pF | GRM1882C2A4R4CA01# | |
| | | 4.5pF | | ±0.05pF | GRM1882C2A4R5WA01# | |
| | | | | ±0.1pF | GRM1882C2A4R5BA01# | |
| | | | | ±0.25pF | GRM1882C2A4R5CA01# | |
| | | 4.6pF | | ±0.05pF | GRM1882C2A4R6WA01# | |
| | | | | ±0.1pF | GRM1882C2A4R6BA01# | |
| | | | | ±0.25pF | GRM1882C2A4R6CA01# | |
| | | 4.7pF | | ±0.05pF | GRM1882C2A4R7WA01# | |
| | | | | ±0.1pF | GRM1882C2A4R7BA01# | |
| | | | | ±0.25pF | GRM1882C2A4R7CA01# | |
| | | 4.8pF | ±0.05pF | GRM1882C2A4R8WA01# | | |
| | | | ±0.1pF | GRM1882C2A4R8BA01# | | |
| | | | ±0.25pF | GRM1882C2A4R8CA01# | | |
| | | 4.9pF | ±0.05pF | GRM1882C2A4R9WA01# | | |
| | | | ±0.1pF | GRM1882C2A4R9BA01# | | |
| | | | ±0.25pF | GRM1882C2A4R9CA01# | | |
| | | 5.0pF | ±0.05pF | GRM1882C2A5R0WA01# | | |
| | | | ±0.1pF | GRM1882C2A5R0BA01# | | |
| | | | ±0.25pF | GRM1882C2A5R0CA01# | | |
| 5.1pF | ±0.05pF | GRM1882C2A5R1WA01# | | | | |
| | ±0.1pF | GRM1882C2A5R1BA01# | | | | |
| | ±0.25pF | GRM1882C2A5R1CA01# | | | | |
| 5.2pF | ±0.5pF | GRM1882C2A5R1DA01# | | | | |
| | ±0.1pF | GRM1882C2A5R2WA01# | | | | |
| | | | | | ±0.1pF | GRM1882C2A5R2BA01# |

Part number # indicates the package specification code.

For General Purpose GRM Series

Capacitor Array GNM Series

Low ESL LL Series

High-Q Type GJM Series

High Frequency GQM Series

Monolithic Microchip GMA Series

For Bonding GMD Series

Product Information

GRM Series Temperature Compensating Type Part Number List

(→ ■ 1.6x0.8mm)

| T max. | Rated Voltage | TC Code | Cap. | Tol. | Part Number |
|--------|---------------|---------|-------|---------|--------------------|
| 0.9mm | 100Vdc | CH | 5.2pF | ±0.25pF | GRM1882C2A5R2CA01# |
| | | | | ±0.5pF | GRM1882C2A5R2DA01# |
| | | | 5.3pF | ±0.05pF | GRM1882C2A5R3WA01# |
| | | | | ±0.1pF | GRM1882C2A5R3BA01# |
| | | | | ±0.25pF | GRM1882C2A5R3CA01# |
| | | | | ±0.5pF | GRM1882C2A5R3DA01# |
| | | | 5.4pF | ±0.05pF | GRM1882C2A5R4WA01# |
| | | | | ±0.1pF | GRM1882C2A5R4BA01# |
| | | | | ±0.25pF | GRM1882C2A5R4CA01# |
| | | | | ±0.5pF | GRM1882C2A5R4DA01# |
| | | | 5.5pF | ±0.05pF | GRM1882C2A5R5WA01# |
| | | | | ±0.1pF | GRM1882C2A5R5BA01# |
| | | | | ±0.25pF | GRM1882C2A5R5CA01# |
| | | | | ±0.5pF | GRM1882C2A5R5DA01# |
| | | | 5.6pF | ±0.05pF | GRM1882C2A5R6WA01# |
| | | | | ±0.1pF | GRM1882C2A5R6BA01# |
| | | | | ±0.25pF | GRM1882C2A5R6CA01# |
| | | | | ±0.5pF | GRM1882C2A5R6DA01# |
| | | | 5.7pF | ±0.05pF | GRM1882C2A5R7WA01# |
| | | | | ±0.1pF | GRM1882C2A5R7BA01# |
| | | | | ±0.25pF | GRM1882C2A5R7CA01# |
| | | | | ±0.5pF | GRM1882C2A5R7DA01# |
| | | | 5.8pF | ±0.05pF | GRM1882C2A5R8WA01# |
| | | | | ±0.1pF | GRM1882C2A5R8BA01# |
| | | | | ±0.25pF | GRM1882C2A5R8CA01# |
| | | | | ±0.5pF | GRM1882C2A5R8DA01# |
| | | | 5.9pF | ±0.05pF | GRM1882C2A5R9WA01# |
| | | | | ±0.1pF | GRM1882C2A5R9BA01# |
| | | | | ±0.25pF | GRM1882C2A5R9CA01# |
| | | | | ±0.5pF | GRM1882C2A5R9DA01# |
| | | | 6.0pF | ±0.05pF | GRM1882C2A6R0WA01# |
| | | | | ±0.1pF | GRM1882C2A6R0BA01# |
| | | | | ±0.25pF | GRM1882C2A6R0CA01# |
| | | | | ±0.5pF | GRM1882C2A6R0DA01# |
| | | | 6.1pF | ±0.05pF | GRM1882C2A6R1WA01# |
| | | | | ±0.1pF | GRM1882C2A6R1BA01# |
| | | | | ±0.25pF | GRM1882C2A6R1CA01# |
| | | | | ±0.5pF | GRM1882C2A6R1DA01# |
| | | | 6.2pF | ±0.05pF | GRM1882C2A6R2WA01# |
| | | | | ±0.1pF | GRM1882C2A6R2BA01# |
| | | | | ±0.25pF | GRM1882C2A6R2CA01# |
| | | | | ±0.5pF | GRM1882C2A6R2DA01# |
| | | | 6.3pF | ±0.05pF | GRM1882C2A6R3WA01# |
| | | | | ±0.1pF | GRM1882C2A6R3BA01# |
| | | | | ±0.25pF | GRM1882C2A6R3CA01# |
| | | | | ±0.5pF | GRM1882C2A6R3DA01# |
| | | | 6.4pF | ±0.05pF | GRM1882C2A6R4WA01# |
| | | | | ±0.1pF | GRM1882C2A6R4BA01# |
| | | | | ±0.25pF | GRM1882C2A6R4CA01# |
| | | | | ±0.5pF | GRM1882C2A6R4DA01# |
| | | | 6.5pF | ±0.05pF | GRM1882C2A6R5WA01# |
| | | | | ±0.1pF | GRM1882C2A6R5BA01# |
| | | | | ±0.25pF | GRM1882C2A6R5CA01# |
| | | | | ±0.5pF | GRM1882C2A6R5DA01# |

| T max. | Rated Voltage | TC Code | Cap. | Tol. | Part Number |
|--------|---------------|---------|-------|---------|--------------------|
| 0.9mm | 100Vdc | CH | 6.6pF | ±0.05pF | GRM1882C2A6R6WA01# |
| | | | | ±0.1pF | GRM1882C2A6R6BA01# |
| | | | | ±0.25pF | GRM1882C2A6R6CA01# |
| | | | | ±0.5pF | GRM1882C2A6R6DA01# |
| | | | 6.7pF | ±0.05pF | GRM1882C2A6R7WA01# |
| | | | | ±0.1pF | GRM1882C2A6R7BA01# |
| | | | | ±0.25pF | GRM1882C2A6R7CA01# |
| | | | 6.8pF | ±0.05pF | GRM1882C2A6R8WA01# |
| | | | | ±0.1pF | GRM1882C2A6R8BA01# |
| | | | | ±0.25pF | GRM1882C2A6R8CA01# |
| | | | 6.9pF | ±0.05pF | GRM1882C2A6R9WA01# |
| | | | | ±0.1pF | GRM1882C2A6R9BA01# |
| | | | | ±0.25pF | GRM1882C2A6R9CA01# |
| | | | 7.0pF | ±0.05pF | GRM1882C2A7R0WA01# |
| | | | | ±0.1pF | GRM1882C2A7R0BA01# |
| | | | | ±0.25pF | GRM1882C2A7R0CA01# |
| | | | 7.1pF | ±0.05pF | GRM1882C2A7R1WA01# |
| | | | | ±0.1pF | GRM1882C2A7R1BA01# |
| | | | | ±0.25pF | GRM1882C2A7R1CA01# |
| | | | 7.2pF | ±0.05pF | GRM1882C2A7R2WA01# |
| | | | | ±0.1pF | GRM1882C2A7R2BA01# |
| | | | | ±0.25pF | GRM1882C2A7R2CA01# |
| | | | 7.3pF | ±0.05pF | GRM1882C2A7R3WA01# |
| | | | | ±0.1pF | GRM1882C2A7R3BA01# |
| | | | | ±0.25pF | GRM1882C2A7R3CA01# |
| | | | 7.4pF | ±0.05pF | GRM1882C2A7R4WA01# |
| | | | | ±0.1pF | GRM1882C2A7R4BA01# |
| | | | | ±0.25pF | GRM1882C2A7R4CA01# |
| | | | 7.5pF | ±0.05pF | GRM1882C2A7R5WA01# |
| | | | | ±0.1pF | GRM1882C2A7R5BA01# |
| | | | | ±0.25pF | GRM1882C2A7R5CA01# |
| | | | 7.6pF | ±0.05pF | GRM1882C2A7R6WA01# |
| | | | | ±0.1pF | GRM1882C2A7R6BA01# |
| | | | | ±0.25pF | GRM1882C2A7R6CA01# |
| | | | 7.7pF | ±0.05pF | GRM1882C2A7R7WA01# |
| | | | | ±0.1pF | GRM1882C2A7R7BA01# |
| | | | | ±0.25pF | GRM1882C2A7R7CA01# |
| | | | 7.8pF | ±0.05pF | GRM1882C2A7R8WA01# |
| | | | | ±0.1pF | GRM1882C2A7R8BA01# |
| | | | | ±0.25pF | GRM1882C2A7R8CA01# |
| | | | 7.9pF | ±0.05pF | GRM1882C2A7R9WA01# |
| | | | | ±0.1pF | GRM1882C2A7R9BA01# |
| | | | | ±0.25pF | GRM1882C2A7R9CA01# |

Part number # indicates the package specification code.

For General Purpose
GRM Series

Capacitor Array
GNM Series

Low ESL
LL□ Series

High-Q Type
GJM Series

High Frequency
GQM Series

Monolithic Microchip
GMA Series

For Bonding
GMD Series

Product Information

GRM Series Temperature Compensating Type Part Number List

(→ ■ 1.6x0.8mm)

| T max. | Rated Voltage | TC Code | Cap. | Tol. | Part Number |
|---------|--------------------|--------------------|-------|---------|--------------------|
| 0.9mm | 100Vdc | CH | 7.9pF | ±0.25pF | GRM1882C2A7R9CA01# |
| | | | | ±0.5pF | GRM1882C2A7R9DA01# |
| | | | 8.0pF | ±0.05pF | GRM1882C2A8R0WA01# |
| | | | | ±0.1pF | GRM1882C2A8R0BA01# |
| | | | | ±0.25pF | GRM1882C2A8R0CA01# |
| | | | | ±0.5pF | GRM1882C2A8R0DA01# |
| | | | 8.1pF | ±0.05pF | GRM1882C2A8R1WA01# |
| | | | | ±0.1pF | GRM1882C2A8R1BA01# |
| | | | | ±0.25pF | GRM1882C2A8R1CA01# |
| | | | | ±0.5pF | GRM1882C2A8R1DA01# |
| | | | 8.2pF | ±0.05pF | GRM1882C2A8R2WA01# |
| | | | | ±0.1pF | GRM1882C2A8R2BA01# |
| | | | | ±0.25pF | GRM1882C2A8R2CA01# |
| | | | | ±0.5pF | GRM1882C2A8R2DA01# |
| | | | 8.3pF | ±0.05pF | GRM1882C2A8R3WA01# |
| | | | | ±0.1pF | GRM1882C2A8R3BA01# |
| | | | | ±0.25pF | GRM1882C2A8R3CA01# |
| | | | | ±0.5pF | GRM1882C2A8R3DA01# |
| | | | 8.4pF | ±0.05pF | GRM1882C2A8R4WA01# |
| | | | | ±0.1pF | GRM1882C2A8R4BA01# |
| | | | | ±0.25pF | GRM1882C2A8R4CA01# |
| | | | | ±0.5pF | GRM1882C2A8R4DA01# |
| | | | 8.5pF | ±0.05pF | GRM1882C2A8R5WA01# |
| | | | | ±0.1pF | GRM1882C2A8R5BA01# |
| | | | | ±0.25pF | GRM1882C2A8R5CA01# |
| | | | | ±0.5pF | GRM1882C2A8R5DA01# |
| | | | 8.6pF | ±0.05pF | GRM1882C2A8R6WA01# |
| | | | | ±0.1pF | GRM1882C2A8R6BA01# |
| | | | | ±0.25pF | GRM1882C2A8R6CA01# |
| | | | | ±0.5pF | GRM1882C2A8R6DA01# |
| | | | 8.7pF | ±0.05pF | GRM1882C2A8R7WA01# |
| | | | | ±0.1pF | GRM1882C2A8R7BA01# |
| | | | | ±0.25pF | GRM1882C2A8R7CA01# |
| | | | | ±0.5pF | GRM1882C2A8R7DA01# |
| | | | 8.8pF | ±0.05pF | GRM1882C2A8R8WA01# |
| | | | | ±0.1pF | GRM1882C2A8R8BA01# |
| | | | | ±0.25pF | GRM1882C2A8R8CA01# |
| | | | | ±0.5pF | GRM1882C2A8R8DA01# |
| | | | 8.9pF | ±0.05pF | GRM1882C2A8R9WA01# |
| | | | | ±0.1pF | GRM1882C2A8R9BA01# |
| | | | | ±0.25pF | GRM1882C2A8R9CA01# |
| | | | | ±0.5pF | GRM1882C2A8R9DA01# |
| | | | 9.0pF | ±0.05pF | GRM1882C2A9R0WA01# |
| | | | | ±0.1pF | GRM1882C2A9R0BA01# |
| | | | | ±0.25pF | GRM1882C2A9R0CA01# |
| | | | | ±0.5pF | GRM1882C2A9R0DA01# |
| | | | 9.1pF | ±0.05pF | GRM1882C2A9R1WA01# |
| | | | | ±0.1pF | GRM1882C2A9R1BA01# |
| ±0.25pF | GRM1882C2A9R1CA01# | | | | |
| ±0.5pF | GRM1882C2A9R1DA01# | | | | |
| 9.2pF | ±0.05pF | GRM1882C2A9R2WA01# | | | |
| | ±0.1pF | GRM1882C2A9R2BA01# | | | |
| | ±0.25pF | GRM1882C2A9R2CA01# | | | |
| | ±0.5pF | GRM1882C2A9R2DA01# | | | |

| T max. | Rated Voltage | TC Code | Cap. | Tol. | Part Number |
|--------|---------------|--------------------|-------|---------|--------------------|
| 0.9mm | 100Vdc | CH | 9.3pF | ±0.05pF | GRM1882C2A9R3WA01# |
| | | | | ±0.1pF | GRM1882C2A9R3BA01# |
| | | | | ±0.25pF | GRM1882C2A9R3CA01# |
| | | | | ±0.5pF | GRM1882C2A9R3DA01# |
| | | | 9.4pF | ±0.05pF | GRM1882C2A9R4WA01# |
| | | | | ±0.1pF | GRM1882C2A9R4BA01# |
| | | | | ±0.25pF | GRM1882C2A9R4CA01# |
| | | | | ±0.5pF | GRM1882C2A9R4DA01# |
| | | | 9.5pF | ±0.05pF | GRM1882C2A9R5WA01# |
| | | | | ±0.1pF | GRM1882C2A9R5BA01# |
| | | | | ±0.25pF | GRM1882C2A9R5CA01# |
| | | | | ±0.5pF | GRM1882C2A9R5DA01# |
| | | | 9.6pF | ±0.05pF | GRM1882C2A9R6WA01# |
| | | | | ±0.1pF | GRM1882C2A9R6BA01# |
| | | | | ±0.25pF | GRM1882C2A9R6CA01# |
| | | | | ±0.5pF | GRM1882C2A9R6DA01# |
| | | | 9.7pF | ±0.05pF | GRM1882C2A9R7WA01# |
| | | | | ±0.1pF | GRM1882C2A9R7BA01# |
| | | | | ±0.25pF | GRM1882C2A9R7CA01# |
| | | | | ±0.5pF | GRM1882C2A9R7DA01# |
| | | | 9.8pF | ±0.05pF | GRM1882C2A9R8WA01# |
| | | | | ±0.1pF | GRM1882C2A9R8BA01# |
| | | | | ±0.25pF | GRM1882C2A9R8CA01# |
| | | | | ±0.5pF | GRM1882C2A9R8DA01# |
| | | | 9.9pF | ±0.05pF | GRM1882C2A9R9WA01# |
| | | | | ±0.1pF | GRM1882C2A9R9BA01# |
| | | | | ±0.25pF | GRM1882C2A9R9CA01# |
| | | | | ±0.5pF | GRM1882C2A9R9DA01# |
| | | | 10pF | ±5% | GRM1882C2A100JA01# |
| | | | 12pF | ±5% | GRM1882C2A120JA01# |
| | | | 15pF | ±5% | GRM1882C2A150JA01# |
| | | | 18pF | ±5% | GRM1882C2A180JA01# |
| | | | 22pF | ±5% | GRM1882C2A220JA01# |
| | | | 27pF | ±5% | GRM1882C2A270JA01# |
| | | | 33pF | ±5% | GRM1882C2A330JA01# |
| | | | 39pF | ±5% | GRM1882C2A390JA01# |
| | | | 47pF | ±5% | GRM1882C2A470JA01# |
| | | | 56pF | ±5% | GRM1882C2A560JA01# |
| | | | 68pF | ±5% | GRM1882C2A680JA01# |
| | | | 82pF | ±5% | GRM1882C2A820JA01# |
| | | | 100pF | ±5% | GRM1882C2A101JA01# |
| | | | 120pF | ±5% | GRM1882C2A121JA01# |
| | | | 150pF | ±5% | GRM1882C2A151JA01# |
| | | | 180pF | ±5% | GRM1882C2A181JA01# |
| | | | 220pF | ±5% | GRM1882C2A221JA01# |
| | | | 270pF | ±5% | GRM1882C2A271JA01# |
| | | | 330pF | ±5% | GRM1882C2A331JA01# |
| | | | 390pF | ±5% | GRM1882C2A391JA01# |
| 470pF | ±5% | GRM1882C2A471JA01# | | | |
| 560pF | ±5% | GRM1882C2A561JA01# | | | |
| 680pF | ±5% | GRM1882C2A681JA01# | | | |
| 820pF | ±5% | GRM1882C2A821JA01# | | | |
| 1000pF | ±5% | GRM1882C2A102JA01# | | | |
| 1200pF | ±5% | GRM1882C2A122JA01# | | | |

Part number # indicates the package specification code.

For General Purpose GRM Series
 Capacitor Array GNM Series
 Low ESL LLI Series
 High-Q Type GJM Series
 High Frequency GQM Series
 Monolithic Microchip GMA Series
 For Bonding GMD Series
 Product Information

GRM Series Temperature Compensating Type Part Number List

(→ ■ 1.6x0.8mm)

| T max. | Rated Voltage | TC Code | Cap. | Tol. | Part Number | T max. | Rated Voltage | TC Code | Cap. | Tol. | Part Number | |
|--------|---------------|---------|--------|---------|--------------------|--------|---------------|---------|---------|--------------------|--------------------|---------|
| 0.9mm | 100Vdc | CH | 1500pF | ±5% | GRM1882C2A152JA01# | 0.9mm | 50Vdc | C0G | 2.4pF | ±0.1pF | GRM1885C1H2R4BA01# | |
| | 50Vdc | C0G | 0.5pF | ±0.05pF | GRM1885C1HR50WA01# | | | | | ±0.25pF | GRM1885C1H2R4CA01# | |
| | | | | ±0.1pF | GRM1885C1HR50BA01# | | | | 2.5pF | ±0.05pF | GRM1885C1H2R5WA01# | |
| | | | 0.6pF | ±0.05pF | GRM1885C1HR60WA01# | | | | | ±0.1pF | GRM1885C1H2R5BA01# | |
| | | | | ±0.1pF | GRM1885C1HR60BA01# | | | | ±0.25pF | GRM1885C1H2R5CA01# | 2.6pF | ±0.05pF |
| | | | 0.7pF | ±0.05pF | GRM1885C1HR70WA01# | | | | ±0.1pF | GRM1885C1H2R6BA01# | | |
| | | | | ±0.1pF | GRM1885C1HR70BA01# | | | | ±0.25pF | GRM1885C1H2R6CA01# | 2.7pF | ±0.05pF |
| | | | 0.8pF | ±0.05pF | GRM1885C1HR80WA01# | | | | ±0.1pF | GRM1885C1HR80BA01# | | ±0.1pF |
| | | | | ±0.25pF | GRM1885C1HR80CA01# | | | | ±0.25pF | GRM1885C1H2R7CA01# | 2.8pF | ±0.05pF |
| | | | 0.9pF | ±0.05pF | GRM1885C1HR90WA01# | | | | ±0.1pF | GRM1885C1H1R0BA01# | | ±0.1pF |
| | | | | ±0.25pF | GRM1885C1HR90CA01# | | | | ±0.25pF | GRM1885C1H1R0CA01# | 2.9pF | ±0.05pF |
| | | | 1.0pF | ±0.05pF | GRM1885C1H1R0WA01# | | | | ±0.1pF | GRM1885C1H1R1BA01# | | ±0.1pF |
| | | | | ±0.25pF | GRM1885C1H1R0CA01# | | | | ±0.25pF | GRM1885C1H1R1CA01# | 3.0pF | ±0.05pF |
| | | | 1.1pF | ±0.05pF | GRM1885C1H1R1WA01# | | | | ±0.1pF | GRM1885C1H1R2BA01# | | ±0.1pF |
| | | | | ±0.25pF | GRM1885C1H1R1CA01# | | | | ±0.25pF | GRM1885C1H1R2CA01# | 3.1pF | ±0.05pF |
| | | | 1.2pF | ±0.05pF | GRM1885C1H1R2WA01# | | | | ±0.1pF | GRM1885C1H1R3BA01# | | ±0.1pF |
| | | | | ±0.25pF | GRM1885C1H1R2CA01# | | | | ±0.25pF | GRM1885C1H1R3CA01# | 3.2pF | ±0.05pF |
| | | | 1.3pF | ±0.05pF | GRM1885C1H1R3WA01# | | | | ±0.1pF | GRM1885C1H1R4BA01# | | ±0.1pF |
| | | | | ±0.25pF | GRM1885C1H1R3CA01# | | | | ±0.25pF | GRM1885C1H1R4CA01# | 3.3pF | ±0.05pF |
| | | | 1.4pF | ±0.05pF | GRM1885C1H1R4WA01# | | | | ±0.1pF | GRM1885C1H1R5BA01# | | ±0.1pF |
| | | | | ±0.25pF | GRM1885C1H1R4CA01# | | | | ±0.25pF | GRM1885C1H1R5CA01# | 3.4pF | ±0.05pF |
| | | | 1.5pF | ±0.05pF | GRM1885C1H1R5WA01# | | | | ±0.1pF | GRM1885C1H1R6BA01# | | ±0.1pF |
| | | | | ±0.25pF | GRM1885C1H1R5CA01# | | | | ±0.25pF | GRM1885C1H1R6CA01# | 3.5pF | ±0.05pF |
| | | | 1.6pF | ±0.05pF | GRM1885C1H1R6WA01# | | | | ±0.1pF | GRM1885C1H1R7BA01# | | ±0.1pF |
| | | | | ±0.25pF | GRM1885C1H1R6CA01# | | | | ±0.25pF | GRM1885C1H1R7CA01# | 3.6pF | ±0.05pF |
| | | | 1.7pF | ±0.05pF | GRM1885C1H1R7WA01# | | | | ±0.1pF | GRM1885C1H1R8BA01# | | ±0.1pF |
| | | | | ±0.25pF | GRM1885C1H1R7CA01# | | | | ±0.25pF | GRM1885C1H1R8CA01# | 3.7pF | ±0.05pF |
| | | | 1.8pF | ±0.05pF | GRM1885C1H1R8WA01# | | | | ±0.1pF | GRM1885C1H1R9BA01# | | ±0.1pF |
| | | | | ±0.25pF | GRM1885C1H1R8CA01# | | | | ±0.25pF | GRM1885C1H1R9CA01# | 3.8pF | ±0.05pF |
| | | | 1.9pF | ±0.05pF | GRM1885C1H1R9WA01# | | | | ±0.1pF | GRM1885C1H2R0BA01# | | ±0.1pF |
| | | | | ±0.25pF | GRM1885C1H1R9CA01# | | | | ±0.25pF | GRM1885C1H2R0CA01# | 3.9pF | ±0.05pF |
| | | | 2.0pF | ±0.05pF | GRM1885C1H2R0WA01# | | | | ±0.1pF | GRM1885C1H2R1BA01# | | ±0.1pF |
| | | | | ±0.25pF | GRM1885C1H2R0CA01# | | | | ±0.25pF | GRM1885C1H2R1CA01# | 4.0pF | ±0.05pF |
| | | | 2.1pF | ±0.05pF | GRM1885C1H2R1WA01# | | | | ±0.1pF | GRM1885C1H2R2BA01# | | ±0.1pF |
| | | | | ±0.25pF | GRM1885C1H2R1CA01# | | | | ±0.25pF | GRM1885C1H2R2CA01# | 4.1pF | ±0.05pF |
| | | | 2.2pF | ±0.05pF | GRM1885C1H2R2WA01# | | | | ±0.1pF | GRM1885C1H2R3BA01# | | ±0.1pF |
| | | | | ±0.25pF | GRM1885C1H2R2CA01# | | | | ±0.25pF | GRM1885C1H2R3CA01# | 4.2pF | ±0.05pF |
| | | | 2.3pF | ±0.05pF | GRM1885C1H2R3WA01# | | | | ±0.1pF | GRM1885C1H2R4WA01# | | |
| | | | | ±0.25pF | GRM1885C1H2R3CA01# | | | | | | | |

Part number # indicates the package specification code.

GRM Series Temperature Compensating Type Part Number List

(→ ■ 1.6x0.8mm)

| T max. | Rated Voltage | TC Code | Cap. | Tol. | Part Number |
|--------|---------------|---------|-------|---------|--------------------|
| 0.9mm | 50Vdc | C0G | 4.2pF | ±0.1pF | GRM1885C1H4R2BA01# |
| | | | | ±0.25pF | GRM1885C1H4R2CA01# |
| | | | 4.3pF | ±0.05pF | GRM1885C1H4R3WA01# |
| | | | | ±0.1pF | GRM1885C1H4R3BA01# |
| | | | 4.4pF | ±0.05pF | GRM1885C1H4R4WA01# |
| | | | | ±0.1pF | GRM1885C1H4R4BA01# |
| | | | | ±0.25pF | GRM1885C1H4R4CA01# |
| | | | 4.5pF | ±0.05pF | GRM1885C1H4R5WA01# |
| | | | | ±0.1pF | GRM1885C1H4R5BA01# |
| | | | | ±0.25pF | GRM1885C1H4R5CA01# |
| | | | 4.6pF | ±0.05pF | GRM1885C1H4R6WA01# |
| | | | | ±0.1pF | GRM1885C1H4R6BA01# |
| | | | | ±0.25pF | GRM1885C1H4R6CA01# |
| | | | 4.7pF | ±0.05pF | GRM1885C1H4R7WA01# |
| | | | | ±0.1pF | GRM1885C1H4R7BA01# |
| | | | | ±0.25pF | GRM1885C1H4R7CA01# |
| | | | 4.8pF | ±0.05pF | GRM1885C1H4R8WA01# |
| | | | | ±0.1pF | GRM1885C1H4R8BA01# |
| | | | | ±0.25pF | GRM1885C1H4R8CA01# |
| | | | 4.9pF | ±0.05pF | GRM1885C1H4R9WA01# |
| | | | | ±0.1pF | GRM1885C1H4R9BA01# |
| | | | | ±0.25pF | GRM1885C1H4R9CA01# |
| | | | 5.0pF | ±0.05pF | GRM1885C1H5R0WA01# |
| | | | | ±0.1pF | GRM1885C1H5R0BA01# |
| | | | | ±0.25pF | GRM1885C1H5R0CA01# |
| | | | 5.1pF | ±0.05pF | GRM1885C1H5R1WA01# |
| | | | | ±0.1pF | GRM1885C1H5R1BA01# |
| | | | | ±0.25pF | GRM1885C1H5R1CA01# |
| | | | | ±0.5pF | GRM1885C1H5R1DA01# |
| | | | 5.2pF | ±0.05pF | GRM1885C1H5R2WA01# |
| | | | | ±0.1pF | GRM1885C1H5R2BA01# |
| | | | | ±0.25pF | GRM1885C1H5R2CA01# |
| | | | | ±0.5pF | GRM1885C1H5R2DA01# |
| | | | 5.3pF | ±0.05pF | GRM1885C1H5R3WA01# |
| | | | | ±0.1pF | GRM1885C1H5R3BA01# |
| | | | | ±0.25pF | GRM1885C1H5R3CA01# |
| | | | | ±0.5pF | GRM1885C1H5R3DA01# |
| | | | 5.4pF | ±0.05pF | GRM1885C1H5R4WA01# |
| | | | | ±0.1pF | GRM1885C1H5R4BA01# |
| | | | | ±0.25pF | GRM1885C1H5R4CA01# |
| | | | | ±0.5pF | GRM1885C1H5R4DA01# |
| | | | 5.5pF | ±0.05pF | GRM1885C1H5R5WA01# |
| | | | | ±0.1pF | GRM1885C1H5R5BA01# |
| | | | | ±0.25pF | GRM1885C1H5R5CA01# |
| | | | | ±0.5pF | GRM1885C1H5R5DA01# |
| | | | 5.6pF | ±0.05pF | GRM1885C1H5R6WA01# |
| | | | | ±0.1pF | GRM1885C1H5R6BA01# |
| | | | | ±0.25pF | GRM1885C1H5R6CA01# |
| | | | | ±0.5pF | GRM1885C1H5R6DA01# |
| | | | 5.7pF | ±0.05pF | GRM1885C1H5R7WA01# |
| | | | | ±0.1pF | GRM1885C1H5R7BA01# |
| | | | | ±0.25pF | GRM1885C1H5R7CA01# |
| | | | | ±0.5pF | GRM1885C1H5R7DA01# |

| T max. | Rated Voltage | TC Code | Cap. | Tol. | Part Number |
|---------|--------------------|--------------------|-------|---------|--------------------|
| 0.9mm | 50Vdc | C0G | 5.8pF | ±0.05pF | GRM1885C1H5R8WA01# |
| | | | | ±0.1pF | GRM1885C1H5R8BA01# |
| | | | | ±0.25pF | GRM1885C1H5R8CA01# |
| | | | | ±0.5pF | GRM1885C1H5R8DA01# |
| | | | 5.9pF | ±0.05pF | GRM1885C1H5R9WA01# |
| | | | | ±0.1pF | GRM1885C1H5R9BA01# |
| | | | | ±0.25pF | GRM1885C1H5R9CA01# |
| | | | | ±0.5pF | GRM1885C1H5R9DA01# |
| | | | 6.0pF | ±0.05pF | GRM1885C1H6R0WA01# |
| | | | | ±0.1pF | GRM1885C1H6R0BA01# |
| | | | | ±0.25pF | GRM1885C1H6R0CA01# |
| | | | | ±0.5pF | GRM1885C1H6R0DA01# |
| | | | 6.1pF | ±0.05pF | GRM1885C1H6R1WA01# |
| | | | | ±0.1pF | GRM1885C1H6R1BA01# |
| | | | | ±0.25pF | GRM1885C1H6R1CA01# |
| | | | | ±0.5pF | GRM1885C1H6R1DA01# |
| | | | 6.2pF | ±0.05pF | GRM1885C1H6R2WA01# |
| | | | | ±0.1pF | GRM1885C1H6R2BA01# |
| | | | | ±0.25pF | GRM1885C1H6R2CA01# |
| | | | | ±0.5pF | GRM1885C1H6R2DA01# |
| | | | 6.3pF | ±0.05pF | GRM1885C1H6R3WA01# |
| | | | | ±0.1pF | GRM1885C1H6R3BA01# |
| | | | | ±0.25pF | GRM1885C1H6R3CA01# |
| | | | | ±0.5pF | GRM1885C1H6R3DA01# |
| | | | 6.4pF | ±0.05pF | GRM1885C1H6R4WA01# |
| | | | | ±0.1pF | GRM1885C1H6R4BA01# |
| | | | | ±0.25pF | GRM1885C1H6R4CA01# |
| | | | | ±0.5pF | GRM1885C1H6R4DA01# |
| | | | 6.5pF | ±0.05pF | GRM1885C1H6R5WA01# |
| | | | | ±0.1pF | GRM1885C1H6R5BA01# |
| | | | | ±0.25pF | GRM1885C1H6R5CA01# |
| | | | | ±0.5pF | GRM1885C1H6R5DA01# |
| | | | 6.6pF | ±0.05pF | GRM1885C1H6R6WA01# |
| | | | | ±0.1pF | GRM1885C1H6R6BA01# |
| | | | | ±0.25pF | GRM1885C1H6R6CA01# |
| | | | | ±0.5pF | GRM1885C1H6R6DA01# |
| | | | 6.7pF | ±0.05pF | GRM1885C1H6R7WA01# |
| | | | | ±0.1pF | GRM1885C1H6R7BA01# |
| | | | | ±0.25pF | GRM1885C1H6R7CA01# |
| | | | | ±0.5pF | GRM1885C1H6R7DA01# |
| | | | 6.8pF | ±0.05pF | GRM1885C1H6R8WA01# |
| | | | | ±0.1pF | GRM1885C1H6R8BA01# |
| ±0.25pF | GRM1885C1H6R8CA01# | | | | |
| ±0.5pF | GRM1885C1H6R8DA01# | | | | |
| 6.9pF | ±0.05pF | GRM1885C1H6R9WA01# | | | |
| | ±0.1pF | GRM1885C1H6R9BA01# | | | |
| | ±0.25pF | GRM1885C1H6R9CA01# | | | |
| | ±0.5pF | GRM1885C1H6R9DA01# | | | |
| 7.0pF | ±0.05pF | GRM1885C1H7R0WA01# | | | |
| | ±0.1pF | GRM1885C1H7R0BA01# | | | |
| | ±0.25pF | GRM1885C1H7R0CA01# | | | |
| | ±0.5pF | GRM1885C1H7R0DA01# | | | |
| 7.1pF | ±0.05pF | GRM1885C1H7R1WA01# | | | |
| | ±0.1pF | GRM1885C1H7R1BA01# | | | |

Part number # indicates the package specification code.

For General Purpose GRM Series
 Capacitor Array GNM Series
 Low ESL LL Series
 High-Q Type GJM Series
 High Frequency GQM Series
 Monolithic Microchip GMA Series
 For Bonding GMD Series
 Product Information

GRM Series Temperature Compensating Type Part Number List

(→ ■ 1.6x0.8mm)

| T max. | Rated Voltage | TC Code | Cap. | Tol. | Part Number | T max. | Rated Voltage | TC Code | Cap. | Tol. | Part Number |
|--------|---------------|---------|-------|---------|--------------------|--------|---------------|--------------------|-------|---------|--------------------|
| 0.9mm | 50Vdc | C0G | 7.1pF | ±0.25pF | GRM1885C1H7R1CA01# | 0.9mm | 50Vdc | C0G | 8.5pF | ±0.05pF | GRM1885C1H8R5WA01# |
| | | | | ±0.5pF | GRM1885C1H7R1DA01# | | | | | ±0.1pF | GRM1885C1H8R5BA01# |
| | | | 7.2pF | ±0.05pF | GRM1885C1H7R2WA01# | 8.6pF | ±0.05pF | GRM1885C1H8R6WA01# | | | |
| | | | | ±0.1pF | GRM1885C1H7R2BA01# | | ±0.1pF | GRM1885C1H8R6BA01# | | | |
| | | | | ±0.25pF | GRM1885C1H7R2CA01# | | ±0.25pF | GRM1885C1H8R6CA01# | | | |
| | | | | ±0.5pF | GRM1885C1H7R2DA01# | | ±0.5pF | GRM1885C1H8R6DA01# | | | |
| | | | 7.3pF | ±0.05pF | GRM1885C1H7R3WA01# | 8.7pF | ±0.05pF | GRM1885C1H8R7WA01# | | | |
| | | | | ±0.1pF | GRM1885C1H7R3BA01# | | ±0.1pF | GRM1885C1H8R7BA01# | | | |
| | | | | ±0.25pF | GRM1885C1H7R3CA01# | | ±0.25pF | GRM1885C1H8R7CA01# | | | |
| | | | | ±0.5pF | GRM1885C1H7R3DA01# | | ±0.5pF | GRM1885C1H8R7DA01# | | | |
| | | | 7.4pF | ±0.05pF | GRM1885C1H7R4WA01# | 8.8pF | ±0.05pF | GRM1885C1H8R8WA01# | | | |
| | | | | ±0.1pF | GRM1885C1H7R4BA01# | | ±0.1pF | GRM1885C1H8R8BA01# | | | |
| | | | | ±0.25pF | GRM1885C1H7R4CA01# | | ±0.25pF | GRM1885C1H8R8CA01# | | | |
| | | | | ±0.5pF | GRM1885C1H7R4DA01# | | ±0.5pF | GRM1885C1H8R8DA01# | | | |
| | | | 7.5pF | ±0.05pF | GRM1885C1H7R5WA01# | 8.9pF | ±0.05pF | GRM1885C1H8R9WA01# | | | |
| | | | | ±0.1pF | GRM1885C1H7R5BA01# | | ±0.1pF | GRM1885C1H8R9BA01# | | | |
| | | | | ±0.25pF | GRM1885C1H7R5CA01# | | ±0.25pF | GRM1885C1H8R9CA01# | | | |
| | | | | ±0.5pF | GRM1885C1H7R5DA01# | | ±0.5pF | GRM1885C1H8R9DA01# | | | |
| | | | 7.6pF | ±0.05pF | GRM1885C1H7R6WA01# | 9.0pF | ±0.05pF | GRM1885C1H9R0WA01# | | | |
| | | | | ±0.1pF | GRM1885C1H7R6BA01# | | ±0.1pF | GRM1885C1H9R0BA01# | | | |
| | | | | ±0.25pF | GRM1885C1H7R6CA01# | | ±0.25pF | GRM1885C1H9R0CA01# | | | |
| | | | | ±0.5pF | GRM1885C1H7R6DA01# | | ±0.5pF | GRM1885C1H9R0DA01# | | | |
| | | | 7.7pF | ±0.05pF | GRM1885C1H7R7WA01# | 9.1pF | ±0.05pF | GRM1885C1H9R1WA01# | | | |
| | | | | ±0.1pF | GRM1885C1H7R7BA01# | | ±0.1pF | GRM1885C1H9R1BA01# | | | |
| | | | | ±0.25pF | GRM1885C1H7R7CA01# | | ±0.25pF | GRM1885C1H9R1CA01# | | | |
| | | | | ±0.5pF | GRM1885C1H7R7DA01# | | ±0.5pF | GRM1885C1H9R1DA01# | | | |
| | | | 7.8pF | ±0.05pF | GRM1885C1H7R8WA01# | 9.2pF | ±0.05pF | GRM1885C1H9R2WA01# | | | |
| | | | | ±0.1pF | GRM1885C1H7R8BA01# | | ±0.1pF | GRM1885C1H9R2BA01# | | | |
| | | | | ±0.25pF | GRM1885C1H7R8CA01# | | ±0.25pF | GRM1885C1H9R2CA01# | | | |
| | | | | ±0.5pF | GRM1885C1H7R8DA01# | | ±0.5pF | GRM1885C1H9R2DA01# | | | |
| | | | 7.9pF | ±0.05pF | GRM1885C1H7R9WA01# | 9.3pF | ±0.05pF | GRM1885C1H9R3WA01# | | | |
| | | | | ±0.1pF | GRM1885C1H7R9BA01# | | ±0.1pF | GRM1885C1H9R3BA01# | | | |
| | | | | ±0.25pF | GRM1885C1H7R9CA01# | | ±0.25pF | GRM1885C1H9R3CA01# | | | |
| | | | | ±0.5pF | GRM1885C1H7R9DA01# | | ±0.5pF | GRM1885C1H9R3DA01# | | | |
| | | | 8.0pF | ±0.05pF | GRM1885C1H8R0WA01# | 9.4pF | ±0.05pF | GRM1885C1H9R4WA01# | | | |
| | | | | ±0.1pF | GRM1885C1H8R0BA01# | | ±0.1pF | GRM1885C1H9R4BA01# | | | |
| | | | | ±0.25pF | GRM1885C1H8R0CA01# | | ±0.25pF | GRM1885C1H9R4CA01# | | | |
| | | | | ±0.5pF | GRM1885C1H8R0DA01# | | ±0.5pF | GRM1885C1H9R4DA01# | | | |
| | | | 8.1pF | ±0.05pF | GRM1885C1H8R1WA01# | 9.5pF | ±0.05pF | GRM1885C1H9R5WA01# | | | |
| | | | | ±0.1pF | GRM1885C1H8R1BA01# | | ±0.1pF | GRM1885C1H9R5BA01# | | | |
| | | | | ±0.25pF | GRM1885C1H8R1CA01# | | ±0.25pF | GRM1885C1H9R5CA01# | | | |
| | | | | ±0.5pF | GRM1885C1H8R1DA01# | | ±0.5pF | GRM1885C1H9R5DA01# | | | |
| | | | 8.2pF | ±0.05pF | GRM1885C1H8R2WA01# | 9.6pF | ±0.05pF | GRM1885C1H9R6WA01# | | | |
| | | | | ±0.1pF | GRM1885C1H8R2BA01# | | ±0.1pF | GRM1885C1H9R6BA01# | | | |
| | | | | ±0.25pF | GRM1885C1H8R2CA01# | | ±0.25pF | GRM1885C1H9R6CA01# | | | |
| | | | | ±0.5pF | GRM1885C1H8R2DA01# | | ±0.5pF | GRM1885C1H9R6DA01# | | | |
| | | | 8.3pF | ±0.05pF | GRM1885C1H8R3WA01# | 9.7pF | ±0.05pF | GRM1885C1H9R7WA01# | | | |
| | | | | ±0.1pF | GRM1885C1H8R3BA01# | | ±0.1pF | GRM1885C1H9R7BA01# | | | |
| | | | | ±0.25pF | GRM1885C1H8R3CA01# | | ±0.25pF | GRM1885C1H9R7CA01# | | | |
| | | | | ±0.5pF | GRM1885C1H8R3DA01# | | ±0.5pF | GRM1885C1H9R7DA01# | | | |
| | | | 8.4pF | ±0.05pF | GRM1885C1H8R4WA01# | 9.8pF | ±0.05pF | GRM1885C1H9R8WA01# | | | |
| | | | | ±0.1pF | GRM1885C1H8R4BA01# | | ±0.1pF | GRM1885C1H9R8BA01# | | | |
| | | | | ±0.25pF | GRM1885C1H8R4CA01# | | | | | | |
| | | | | ±0.5pF | GRM1885C1H8R4DA01# | | | | | | |

Part number # indicates the package specification code.

GRM Series Temperature Compensating Type Part Number List

(→ ■ 1.6x0.8mm)

| T max. | Rated Voltage | TC Code | Cap. | Tol. | Part Number | | T max. | Rated Voltage | TC Code | Cap. | Tol. | Part Number | | | | |
|--------|---------------|---------|---------|--------------------|--------------------|-------|--------|---------------|--------------------|---------|--------------------|--------------------|--------------------|--------------------|--------------------|--|
| 0.9mm | 50Vdc | C0G | 9.8pF | ±0.25pF | GRM1885C1H9R8CA01# | | 0.9mm | 50Vdc | CK | 1.2pF | ±0.05pF | GRM1884C1H1R2WA01# | | | | |
| | | | | ±0.5pF | GRM1885C1H9R8DA01# | | | | | | ±0.1pF | GRM1884C1H1R2BA01# | | | | |
| | | | 9.9pF | ±0.05pF | GRM1885C1H9R9WA01# | | | | | | ±0.25pF | GRM1884C1H1R2CA01# | | | | |
| | | | | ±0.1pF | GRM1885C1H9R9BA01# | | | | | | 1.3pF | ±0.05pF | GRM1884C1H1R3WA01# | | | |
| | | | | ±0.25pF | GRM1885C1H9R9CA01# | | | | | | | ±0.1pF | GRM1884C1H1R3BA01# | | | |
| | | | | ±0.5pF | GRM1885C1H9R9DA01# | | | | | | | ±0.25pF | GRM1884C1H1R3CA01# | | | |
| | | | 10pF | ±5% | GRM1885C1H100JA01# | | | | | 1.4pF | ±0.05pF | GRM1884C1H1R4WA01# | | | | |
| | | | 12pF | ±5% | GRM1885C1H120JA01# | | | | | | ±0.1pF | GRM1884C1H1R4BA01# | | | | |
| | | | 15pF | ±5% | GRM1885C1H150JA01# | | | | | | ±0.25pF | GRM1884C1H1R4CA01# | | | | |
| | | | 18pF | ±5% | GRM1885C1H180JA01# | | | | | 1.5pF | ±0.05pF | GRM1884C1H1R5WA01# | | | | |
| | | | 22pF | ±5% | GRM1885C1H220JA01# | | | | | | ±0.1pF | GRM1884C1H1R5BA01# | | | | |
| | | | 27pF | ±5% | GRM1885C1H270JA01# | | | | | | ±0.25pF | GRM1884C1H1R5CA01# | | | | |
| | | | 33pF | ±5% | GRM1885C1H330JA01# | | | | | 1.6pF | ±0.05pF | GRM1884C1H1R6WA01# | | | | |
| | | | 39pF | ±5% | GRM1885C1H390JA01# | | | | | | ±0.1pF | GRM1884C1H1R6BA01# | | | | |
| | | | 47pF | ±5% | GRM1885C1H470JA01# | | | | | | ±0.25pF | GRM1884C1H1R6CA01# | | | | |
| | | | 56pF | ±5% | GRM1885C1H560JA01# | | | | | 1.7pF | ±0.05pF | GRM1884C1H1R7WA01# | | | | |
| | | | 68pF | ±5% | GRM1885C1H680JA01# | | | | | | ±0.1pF | GRM1884C1H1R7BA01# | | | | |
| | | | 82pF | ±5% | GRM1885C1H820JA01# | | | | | | ±0.25pF | GRM1884C1H1R7CA01# | | | | |
| | | | 100pF | ±5% | GRM1885C1H101JA01# | | | | | 1.8pF | ±0.05pF | GRM1884C1H1R8WA01# | | | | |
| | | | 120pF | ±5% | GRM1885C1H121JA01# | | | | | | ±0.1pF | GRM1884C1H1R8BA01# | | | | |
| | | | 150pF | ±5% | GRM1885C1H151JA01# | | | | | | ±0.25pF | GRM1884C1H1R8CA01# | | | | |
| | | | 180pF | ±5% | GRM1885C1H181JA01# | | | | | 1.9pF | ±0.05pF | GRM1884C1H1R9WA01# | | | | |
| | | | 220pF | ±5% | GRM1885C1H221JA01# | | | | | | ±0.1pF | GRM1884C1H1R9BA01# | | | | |
| | | | 270pF | ±5% | GRM1885C1H271JA01# | | | | | | ±0.25pF | GRM1884C1H1R9CA01# | | | | |
| | | | 330pF | ±5% | GRM1885C1H331JA01# | | | | | 2.0pF | ±0.05pF | GRM1884C1H2R0WA01# | | | | |
| | | | 390pF | ±5% | GRM1885C1H391JA01# | | | | | | ±0.1pF | GRM1884C1H2R0BA01# | | | | |
| | | | 470pF | ±5% | GRM1885C1H471JA01# | | | | | | ±0.25pF | GRM1884C1H2R0CA01# | | | | |
| | | | 560pF | ±5% | GRM1885C1H561JA01# | | | | | CJ | 2.1pF | ±0.05pF | GRM1883C1H2R1WA01# | | | |
| | | | 680pF | ±5% | GRM1885C1H681JA01# | | | | | | | ±0.1pF | GRM1883C1H2R1BA01# | | | |
| | | | 820pF | ±5% | GRM1885C1H821JA01# | | | | | | | ±0.25pF | GRM1883C1H2R1CA01# | | | |
| | | | 1000pF | ±5% | GRM1885C1H102JA01# | | | | | 2.2pF | ±0.05pF | GRM1883C1H2R2WA01# | | | | |
| | | | 1200pF | ±5% | GRM1885C1H122JA01# | | | | | | ±0.1pF | GRM1883C1H2R2BA01# | | | | |
| | | | 1500pF | ±5% | GRM1885C1H152JA01# | | | | | | ±0.25pF | GRM1883C1H2R2CA01# | | | | |
| | | | 1800pF | ±5% | GRM1885C1H182JA01# | | | | | 2.3pF | ±0.05pF | GRM1883C1H2R3WA01# | | | | |
| | | | 2200pF | ±5% | GRM1885C1H222JA01# | | | | | | ±0.1pF | GRM1883C1H2R3BA01# | | | | |
| | | | 2700pF | ±5% | GRM1885C1H272JA01# | | | | | | ±0.25pF | GRM1883C1H2R3CA01# | | | | |
| | | | 3300pF | ±5% | GRM1885C1H332JA01# | | | | | 2.4pF | ±0.05pF | GRM1883C1H2R4WA01# | | | | |
| | | | 3900pF | ±5% | GRM1885C1H392JA01# | | | | | | ±0.1pF | GRM1883C1H2R4BA01# | | | | |
| | | | | | | | | | | | ±0.25pF | GRM1883C1H2R4CA01# | | | | |
| | | | | | CK | 0.5pF | | | | ±0.05pF | GRM1884C1HR50WA01# | | 2.5pF | ±0.05pF | GRM1883C1H2R5WA01# | |
| | | | | | | | | | | ±0.1pF | GRM1884C1HR50BA01# | | | ±0.1pF | GRM1883C1H2R5BA01# | |
| | | | | | | 0.6pF | | | | ±0.05pF | GRM1884C1HR60WA01# | | ±0.25pF | GRM1883C1H2R5CA01# | | |
| | | | | | | | | | | ±0.1pF | GRM1884C1HR60BA01# | | 2.6pF | ±0.05pF | GRM1883C1H2R6WA01# | |
| | | | | | | 0.7pF | | | | ±0.05pF | GRM1884C1HR70WA01# | | | ±0.1pF | GRM1883C1H2R6BA01# | |
| | | | | | | | | | | ±0.1pF | GRM1884C1HR70BA01# | | | ±0.25pF | GRM1883C1H2R6CA01# | |
| | | 0.8pF | ±0.05pF | GRM1884C1HR80WA01# | | | 2.7pF | ±0.05pF | GRM1883C1H2R7WA01# | | | | | | | |
| | | | ±0.1pF | GRM1884C1HR80BA01# | | | | ±0.1pF | GRM1883C1H2R7BA01# | | | | | | | |
| | | 0.9pF | ±0.05pF | GRM1884C1HR90WA01# | | | | ±0.25pF | GRM1883C1H2R7CA01# | | | | | | | |
| | | | ±0.1pF | GRM1884C1HR90BA01# | | | 2.8pF | ±0.05pF | GRM1883C1H2R8WA01# | | | | | | | |
| | | 1.0pF | ±0.05pF | GRM1884C1H1R0WA01# | | | | ±0.1pF | GRM1883C1H2R8BA01# | | | | | | | |
| | | | ±0.1pF | GRM1884C1H1R0BA01# | | | | ±0.25pF | GRM1883C1H2R8CA01# | | | | | | | |
| | | | ±0.25pF | GRM1884C1H1R0CA01# | | | 2.9pF | ±0.05pF | GRM1883C1H2R9WA01# | | | | | | | |
| | | 1.1pF | ±0.05pF | GRM1884C1H1R1WA01# | | | | ±0.1pF | GRM1883C1H2R9BA01# | | | | | | | |
| | | | ±0.1pF | GRM1884C1H1R1BA01# | | | | ±0.25pF | GRM1883C1H2R9CA01# | | | | | | | |
| | | | ±0.25pF | GRM1884C1H1R1CA01# | | | | | | | | | | | | |

Part number # indicates the package specification code.

For General Purpose GRM Series
 Capacitor Array GNM Series
 Low ESL LLI Series
 High-Q Type GJM Series
 High Frequency GQM Series
 Monolithic Microchip GMA Series
 For Bonding GMD Series
 Product Information

GRM Series Temperature Compensating Type Part Number List

(→ ■ 1.6x0.8mm)

| T max. | Rated Voltage | TC Code | Cap. | Tol. | Part Number | |
|--------|---------------|---------|-------|---------|--------------------|--------------------|
| 0.9mm | 50Vdc | CJ | 3.0pF | ±0.05pF | GRM1883C1H3R0WA01# | |
| | | | | ±0.1pF | GRM1883C1H3R0BA01# | |
| | | | | ±0.25pF | GRM1883C1H3R0CA01# | |
| | | | 3.1pF | ±0.05pF | GRM1883C1H3R1WA01# | |
| | | | | ±0.1pF | GRM1883C1H3R1BA01# | |
| | | | | ±0.25pF | GRM1883C1H3R1CA01# | |
| | | | 3.2pF | ±0.05pF | GRM1883C1H3R2WA01# | |
| | | | | ±0.1pF | GRM1883C1H3R2BA01# | |
| | | | | ±0.25pF | GRM1883C1H3R2CA01# | |
| | | | 3.3pF | ±0.05pF | GRM1883C1H3R3WA01# | |
| | | | | ±0.1pF | GRM1883C1H3R3BA01# | |
| | | | | ±0.25pF | GRM1883C1H3R3CA01# | |
| | | | 3.4pF | ±0.05pF | GRM1883C1H3R4WA01# | |
| | | | | ±0.1pF | GRM1883C1H3R4BA01# | |
| | | | | ±0.25pF | GRM1883C1H3R4CA01# | |
| | | | 3.5pF | ±0.05pF | GRM1883C1H3R5WA01# | |
| | | | | ±0.1pF | GRM1883C1H3R5BA01# | |
| | | | | ±0.25pF | GRM1883C1H3R5CA01# | |
| | | | 3.6pF | ±0.05pF | GRM1883C1H3R6WA01# | |
| | | | | ±0.1pF | GRM1883C1H3R6BA01# | |
| | | | | ±0.25pF | GRM1883C1H3R6CA01# | |
| | | | 3.7pF | ±0.05pF | GRM1883C1H3R7WA01# | |
| | | | | ±0.1pF | GRM1883C1H3R7BA01# | |
| | | | | ±0.25pF | GRM1883C1H3R7CA01# | |
| | | | 3.8pF | ±0.05pF | GRM1883C1H3R8WA01# | |
| | | | | ±0.1pF | GRM1883C1H3R8BA01# | |
| | | | | ±0.25pF | GRM1883C1H3R8CA01# | |
| | | | 3.9pF | ±0.05pF | GRM1883C1H3R9WA01# | |
| | | | | ±0.1pF | GRM1883C1H3R9BA01# | |
| | | | | ±0.25pF | GRM1883C1H3R9CA01# | |
| | | | CH | 4.0pF | ±0.05pF | GRM1882C1H4R0WA01# |
| | | | | | ±0.1pF | GRM1882C1H4R0BA01# |
| | | | | | ±0.25pF | GRM1882C1H4R0CA01# |
| | | | | 4.1pF | ±0.05pF | GRM1882C1H4R1WA01# |
| | | | | | ±0.1pF | GRM1882C1H4R1BA01# |
| | | | | | ±0.25pF | GRM1882C1H4R1CA01# |
| | | 4.2pF | | ±0.05pF | GRM1882C1H4R2WA01# | |
| | | | | ±0.1pF | GRM1882C1H4R2BA01# | |
| | | | | ±0.25pF | GRM1882C1H4R2CA01# | |
| | | 4.3pF | | ±0.05pF | GRM1882C1H4R3WA01# | |
| | | | | ±0.1pF | GRM1882C1H4R3BA01# | |
| | | | | ±0.25pF | GRM1882C1H4R3CA01# | |
| | | 4.4pF | | ±0.05pF | GRM1882C1H4R4WA01# | |
| | | | | ±0.1pF | GRM1882C1H4R4BA01# | |
| | | | | ±0.25pF | GRM1882C1H4R4CA01# | |
| | | 4.5pF | | ±0.05pF | GRM1882C1H4R5WA01# | |
| | | | | ±0.1pF | GRM1882C1H4R5BA01# | |
| | | | | ±0.25pF | GRM1882C1H4R5CA01# | |
| | | 4.6pF | | ±0.05pF | GRM1882C1H4R6WA01# | |
| | | | | ±0.1pF | GRM1882C1H4R6BA01# | |
| | | | | ±0.25pF | GRM1882C1H4R6CA01# | |
| | | 4.7pF | | ±0.05pF | GRM1882C1H4R7WA01# | |
| | | | | ±0.1pF | GRM1882C1H4R7BA01# | |
| | | | | ±0.25pF | GRM1882C1H4R7CA01# | |

| T max. | Rated Voltage | TC Code | Cap. | Tol. | Part Number |
|--------|---------------|---------|-------|---------|--------------------|
| 0.9mm | 50Vdc | CH | 4.8pF | ±0.05pF | GRM1882C1H4R8WA01# |
| | | | | ±0.1pF | GRM1882C1H4R8BA01# |
| | | | | ±0.25pF | GRM1882C1H4R8CA01# |
| | | | 4.9pF | ±0.05pF | GRM1882C1H4R9WA01# |
| | | | | ±0.1pF | GRM1882C1H4R9BA01# |
| | | | | ±0.25pF | GRM1882C1H4R9CA01# |
| | | | 5.0pF | ±0.05pF | GRM1882C1H5R0WA01# |
| | | | | ±0.1pF | GRM1882C1H5R0BA01# |
| | | | | ±0.25pF | GRM1882C1H5R0CA01# |
| | | | 5.1pF | ±0.05pF | GRM1882C1H5R1WA01# |
| | | | | ±0.1pF | GRM1882C1H5R1BA01# |
| | | | | ±0.25pF | GRM1882C1H5R1CA01# |
| | | | 5.2pF | ±0.05pF | GRM1882C1H5R2WA01# |
| | | | | ±0.1pF | GRM1882C1H5R2BA01# |
| | | | | ±0.25pF | GRM1882C1H5R2CA01# |
| | | | 5.3pF | ±0.05pF | GRM1882C1H5R3WA01# |
| | | | | ±0.1pF | GRM1882C1H5R3BA01# |
| | | | | ±0.25pF | GRM1882C1H5R3CA01# |
| | | | 5.4pF | ±0.05pF | GRM1882C1H5R4WA01# |
| | | | | ±0.1pF | GRM1882C1H5R4BA01# |
| | | | | ±0.25pF | GRM1882C1H5R4CA01# |
| | | | 5.5pF | ±0.05pF | GRM1882C1H5R5WA01# |
| | | | | ±0.1pF | GRM1882C1H5R5BA01# |
| | | | | ±0.25pF | GRM1882C1H5R5CA01# |
| | | | 5.6pF | ±0.05pF | GRM1882C1H5R6WA01# |
| | | | | ±0.1pF | GRM1882C1H5R6BA01# |
| | | | | ±0.25pF | GRM1882C1H5R6CA01# |
| | | | 5.7pF | ±0.05pF | GRM1882C1H5R7WA01# |
| | | | | ±0.1pF | GRM1882C1H5R7BA01# |
| | | | | ±0.25pF | GRM1882C1H5R7CA01# |
| | | | 5.8pF | ±0.05pF | GRM1882C1H5R8WA01# |
| | | | | ±0.1pF | GRM1882C1H5R8BA01# |
| | | | | ±0.25pF | GRM1882C1H5R8CA01# |
| | | | 5.9pF | ±0.05pF | GRM1882C1H5R9WA01# |
| | | | | ±0.1pF | GRM1882C1H5R9BA01# |
| | | | | ±0.25pF | GRM1882C1H5R9CA01# |
| | | | 6.0pF | ±0.05pF | GRM1882C1H6R0WA01# |
| | | | | ±0.1pF | GRM1882C1H6R0BA01# |
| | | | | ±0.25pF | GRM1882C1H6R0CA01# |
| | | | 6.1pF | ±0.05pF | GRM1882C1H6R1WA01# |
| | | | | ±0.1pF | GRM1882C1H6R1BA01# |
| | | | | ±0.25pF | GRM1882C1H6R1CA01# |
| | | | 6.2pF | ±0.05pF | GRM1882C1H6R2WA01# |
| | | | | ±0.1pF | GRM1882C1H6R2BA01# |
| | | | | ±0.25pF | GRM1882C1H6R2CA01# |

Part number # indicates the package specification code.

GRM Series Temperature Compensating Type Part Number List

(→ ■ 1.6x0.8mm)

| T max. | Rated Voltage | TC Code | Cap. | Tol. | Part Number | T max. | Rated Voltage | TC Code | Cap. | Tol. | Part Number | |
|--------|---------------|---------|--------|--------------------|--------------------|--------|---------------|---------|---------|--------------------|--------------------|--------------------|
| 0.9mm | 50Vdc | CH | 6.2pF | ±0.1pF | GRM1882C1H6R2BA01# | 0.9mm | 50Vdc | CH | 7.5pF | ±0.5pF | GRM1882C1H7R5DA01# | |
| | | | | ±0.25pF | GRM1882C1H6R2CA01# | | | | | 7.6pF | ±0.05pF | GRM1882C1H7R6WA01# |
| | | | | ±0.5pF | GRM1882C1H6R2DA01# | | | | | | ±0.1pF | GRM1882C1H7R6BA01# |
| | | | 6.3pF | ±0.05pF | GRM1882C1H6R3WA01# | | | | ±0.25pF | | GRM1882C1H7R6CA01# | |
| | | | | ±0.1pF | GRM1882C1H6R3BA01# | | | | ±0.5pF | GRM1882C1H7R6DA01# | | |
| | | | | ±0.25pF | GRM1882C1H6R3CA01# | | | | 7.7pF | ±0.05pF | GRM1882C1H7R7WA01# | |
| | | | ±0.5pF | GRM1882C1H6R3DA01# | ±0.1pF | | | | | GRM1882C1H7R7BA01# | | |
| | | | 6.4pF | ±0.05pF | GRM1882C1H6R4WA01# | | | | | ±0.25pF | GRM1882C1H7R7CA01# | |
| | | | | ±0.1pF | GRM1882C1H6R4BA01# | | | | ±0.5pF | GRM1882C1H7R7DA01# | | |
| | | | | ±0.25pF | GRM1882C1H6R4CA01# | | | | 7.8pF | ±0.05pF | GRM1882C1H7R8WA01# | |
| | | | ±0.5pF | GRM1882C1H6R4DA01# | ±0.1pF | | | | | GRM1882C1H7R8BA01# | | |
| | | | 6.5pF | ±0.05pF | GRM1882C1H6R5WA01# | | | | | ±0.25pF | GRM1882C1H7R8CA01# | |
| | | | | ±0.1pF | GRM1882C1H6R5BA01# | | | | ±0.5pF | GRM1882C1H7R8DA01# | | |
| | | | | ±0.25pF | GRM1882C1H6R5CA01# | | | | 7.9pF | ±0.05pF | GRM1882C1H7R9WA01# | |
| | | | ±0.5pF | GRM1882C1H6R5DA01# | ±0.1pF | | | | | GRM1882C1H7R9BA01# | | |
| | | | 6.6pF | ±0.05pF | GRM1882C1H6R6WA01# | | | | | ±0.25pF | GRM1882C1H7R9CA01# | |
| | | | | ±0.1pF | GRM1882C1H6R6BA01# | | | | ±0.5pF | GRM1882C1H7R9DA01# | | |
| | | | | ±0.25pF | GRM1882C1H6R6CA01# | | | | 8.0pF | ±0.05pF | GRM1882C1H8R0WA01# | |
| | | | ±0.5pF | GRM1882C1H6R6DA01# | ±0.1pF | | | | | GRM1882C1H8R0BA01# | | |
| | | | 6.7pF | ±0.05pF | GRM1882C1H6R7WA01# | | | | | ±0.25pF | GRM1882C1H8R0CA01# | |
| | | | | ±0.1pF | GRM1882C1H6R7BA01# | | | | ±0.5pF | GRM1882C1H8R0DA01# | | |
| | | | | ±0.25pF | GRM1882C1H6R7CA01# | | | | 8.1pF | ±0.05pF | GRM1882C1H8R1WA01# | |
| | | | ±0.5pF | GRM1882C1H6R7DA01# | ±0.1pF | | | | | GRM1882C1H8R1BA01# | | |
| | | | 6.8pF | ±0.05pF | GRM1882C1H6R8WA01# | | | | | ±0.25pF | GRM1882C1H8R1CA01# | |
| | | | | ±0.1pF | GRM1882C1H6R8BA01# | | | | ±0.5pF | GRM1882C1H8R1DA01# | | |
| | | | | ±0.25pF | GRM1882C1H6R8CA01# | | | | 8.2pF | ±0.05pF | GRM1882C1H8R2WA01# | |
| | | | ±0.5pF | GRM1882C1H6R8DA01# | ±0.1pF | | | | | GRM1882C1H8R2BA01# | | |
| | | | 6.9pF | ±0.05pF | GRM1882C1H6R9WA01# | | | | | ±0.25pF | GRM1882C1H8R2CA01# | |
| | | | | ±0.1pF | GRM1882C1H6R9BA01# | | | | ±0.5pF | GRM1882C1H8R2DA01# | | |
| | | | | ±0.25pF | GRM1882C1H6R9CA01# | | | | 8.3pF | ±0.05pF | GRM1882C1H8R3WA01# | |
| | | | ±0.5pF | GRM1882C1H6R9DA01# | ±0.1pF | | | | | GRM1882C1H8R3BA01# | | |
| | | | 7.0pF | ±0.05pF | GRM1882C1H7R0WA01# | | | | | ±0.25pF | GRM1882C1H8R3CA01# | |
| | | | | ±0.1pF | GRM1882C1H7R0BA01# | | | | ±0.5pF | GRM1882C1H8R3DA01# | | |
| | | | | ±0.25pF | GRM1882C1H7R0CA01# | | | | 8.4pF | ±0.05pF | GRM1882C1H8R4WA01# | |
| | | | ±0.5pF | GRM1882C1H7R0DA01# | ±0.1pF | | | | | GRM1882C1H8R4BA01# | | |
| | | | 7.1pF | ±0.05pF | GRM1882C1H7R1WA01# | | | | | ±0.25pF | GRM1882C1H8R4CA01# | |
| | | | | ±0.1pF | GRM1882C1H7R1BA01# | | | | ±0.5pF | GRM1882C1H8R4DA01# | | |
| | | | | ±0.25pF | GRM1882C1H7R1CA01# | | | | 8.5pF | ±0.05pF | GRM1882C1H8R5WA01# | |
| | | | ±0.5pF | GRM1882C1H7R1DA01# | ±0.1pF | | | | | GRM1882C1H8R5BA01# | | |
| | | | 7.2pF | ±0.05pF | GRM1882C1H7R2WA01# | | | | | ±0.25pF | GRM1882C1H8R5CA01# | |
| | | | | ±0.1pF | GRM1882C1H7R2BA01# | | | | ±0.5pF | GRM1882C1H8R5DA01# | | |
| | | | | ±0.25pF | GRM1882C1H7R2CA01# | | | | 8.6pF | ±0.05pF | GRM1882C1H8R6WA01# | |
| | | | ±0.5pF | GRM1882C1H7R2DA01# | ±0.1pF | | | | | GRM1882C1H8R6BA01# | | |
| | | | 7.3pF | ±0.05pF | GRM1882C1H7R3WA01# | | | | | ±0.25pF | GRM1882C1H8R6CA01# | |
| | | | | ±0.1pF | GRM1882C1H7R3BA01# | | | | ±0.5pF | GRM1882C1H8R6DA01# | | |
| | | | | ±0.25pF | GRM1882C1H7R3CA01# | | | | 8.7pF | ±0.05pF | GRM1882C1H8R7WA01# | |
| | | | ±0.5pF | GRM1882C1H7R3DA01# | ±0.1pF | | | | | GRM1882C1H8R7BA01# | | |
| | | | 7.4pF | ±0.05pF | GRM1882C1H7R4WA01# | | | | | ±0.25pF | GRM1882C1H8R7CA01# | |
| | | | | ±0.1pF | GRM1882C1H7R4BA01# | | | | ±0.5pF | GRM1882C1H8R7DA01# | | |
| | | | | ±0.25pF | GRM1882C1H7R4CA01# | | | | 8.8pF | ±0.05pF | GRM1882C1H8R8WA01# | |
| | | | ±0.5pF | GRM1882C1H7R4DA01# | ±0.1pF | | | | | GRM1882C1H8R8BA01# | | |
| | | | 7.5pF | ±0.05pF | GRM1882C1H7R5WA01# | | | | | ±0.25pF | GRM1882C1H8R8CA01# | |
| | | | | ±0.1pF | GRM1882C1H7R5BA01# | | | | ±0.5pF | GRM1882C1H8R8DA01# | | |
| | | | | ±0.25pF | GRM1882C1H7R5CA01# | | | | 8.9pF | ±0.05pF | GRM1882C1H8R9WA01# | |

Part number # indicates the package specification code.

For General Purpose GRM Series
 Capacitor Array GNM Series
 Low ESL LL Series
 High-Q Type GJM Series
 High Frequency GQM Series
 Monolithic Microchip GMA Series
 For Bonding GMD Series
 Product Information

GRM Series Temperature Compensating Type Part Number List

(→ ■ 1.6x0.8mm)

| T max. | Rated Voltage | TC Code | Cap. | Tol. | Part Number | | T max. | Rated Voltage | TC Code | Cap. | Tol. | Part Number | |
|--------|---------------|---------|-------|---------|--------------------|--|--------|---------------|---------|---------|------|--------------------|--|
| 0.9mm | 50Vdc | CH | 8.9pF | ±0.1pF | GRM1882C1H8R9BA01# | | 0.9mm | 50Vdc | CH | 82pF | ±5% | GRM1882C1H820JA01# | |
| | | | | ±0.25pF | GRM1882C1H8R9CA01# | | | | | 100pF | ±5% | GRM1882C1H101JA01# | |
| | | | | ±0.5pF | GRM1882C1H8R9DA01# | | | | | 120pF | ±5% | GRM1882C1H121JA01# | |
| | | | 9.0pF | ±0.05pF | GRM1882C1H9R0WA01# | | | | | 150pF | ±5% | GRM1882C1H151JA01# | |
| | | | | ±0.1pF | GRM1882C1H9R0BA01# | | | | | 180pF | ±5% | GRM1882C1H181JA01# | |
| | | | | ±0.25pF | GRM1882C1H9R0CA01# | | | | | 220pF | ±5% | GRM1882C1H221JA01# | |
| | | | 9.1pF | ±0.05pF | GRM1882C1H9R1WA01# | | | | | 270pF | ±5% | GRM1882C1H271JA01# | |
| | | | | ±0.1pF | GRM1882C1H9R1BA01# | | | | | 330pF | ±5% | GRM1882C1H331JA01# | |
| | | | | ±0.25pF | GRM1882C1H9R1CA01# | | | | | 390pF | ±5% | GRM1882C1H391JA01# | |
| | | | | ±0.5pF | GRM1882C1H9R1DA01# | | | | | 470pF | ±5% | GRM1882C1H471JA01# | |
| | | | 9.2pF | ±0.05pF | GRM1882C1H9R2WA01# | | | | | 560pF | ±5% | GRM1882C1H561JA01# | |
| | | | | ±0.1pF | GRM1882C1H9R2BA01# | | | | | 680pF | ±5% | GRM1882C1H681JA01# | |
| | | | | ±0.25pF | GRM1882C1H9R2CA01# | | | | | 820pF | ±5% | GRM1882C1H821JA01# | |
| | | | | ±0.5pF | GRM1882C1H9R2DA01# | | | | | 1000pF | ±5% | GRM1882C1H102JA01# | |
| | | | 9.3pF | ±0.05pF | GRM1882C1H9R3WA01# | | | | | 1200pF | ±5% | GRM1882C1H122JA01# | |
| | | | | ±0.1pF | GRM1882C1H9R3BA01# | | | | | 1500pF | ±5% | GRM1882C1H152JA01# | |
| | | | | ±0.25pF | GRM1882C1H9R3CA01# | | | | | 1800pF | ±5% | GRM1882C1H182JA01# | |
| | | | | ±0.5pF | GRM1882C1H9R3DA01# | | | | | 2200pF | ±5% | GRM1882C1H222JA01# | |
| | | | 9.4pF | ±0.05pF | GRM1882C1H9R4WA01# | | | | | 2700pF | ±5% | GRM1882C1H272JA01# | |
| | | | | ±0.1pF | GRM1882C1H9R4BA01# | | | | | 3300pF | ±5% | GRM1882C1H332JA01# | |
| | | | | ±0.25pF | GRM1882C1H9R4CA01# | | | | | 3900pF | ±5% | GRM1882C1H392JA01# | |
| | | | | ±0.5pF | GRM1882C1H9R4DA01# | | | | | 1200pF | ±5% | GRM1881X1H122JA01# | |
| | | | 9.5pF | ±0.05pF | GRM1882C1H9R5WA01# | | | | | 1500pF | ±5% | GRM1881X1H152JA01# | |
| | | | | ±0.1pF | GRM1882C1H9R5BA01# | | | | | 1800pF | ±5% | GRM1881X1H182JA01# | |
| | | | | ±0.25pF | GRM1882C1H9R5CA01# | | | | | 2200pF | ±5% | GRM1881X1H222JA01# | |
| | | | | ±0.5pF | GRM1882C1H9R5DA01# | | | | | 2700pF | ±5% | GRM1881X1H272JA01# | |
| | | | 9.6pF | ±0.05pF | GRM1882C1H9R6WA01# | | | | | 3300pF | ±5% | GRM1881X1H332JA01# | |
| | | | | ±0.1pF | GRM1882C1H9R6BA01# | | | | | 3900pF | ±5% | GRM1881X1H392JA01# | |
| | | | | ±0.25pF | GRM1882C1H9R6CA01# | | | | | 4700pF | ±5% | GRM1881X1H472JA01# | |
| | | | | ±0.5pF | GRM1882C1H9R6DA01# | | | | | 5600pF | ±5% | GRM1881X1H562JA01# | |
| | | | 9.7pF | ±0.05pF | GRM1882C1H9R7WA01# | | | | | 6800pF | ±5% | GRM1881X1H682JA01# | |
| | | | | ±0.1pF | GRM1882C1H9R7BA01# | | | | | 8200pF | ±5% | GRM1881X1H822JA01# | |
| | | | | ±0.25pF | GRM1882C1H9R7CA01# | | | | | 10000pF | ±5% | GRM1881X1H103JA01# | |
| | | | | ±0.5pF | GRM1882C1H9R7DA01# | | | | | 1200pF | ±5% | GRM1887U1H122JA01# | |
| | | | 9.8pF | ±0.05pF | GRM1882C1H9R8WA01# | | | | | 1500pF | ±5% | GRM1887U1H152JA01# | |
| | | | | ±0.1pF | GRM1882C1H9R8BA01# | | | | | 1800pF | ±5% | GRM1887U1H182JA01# | |
| | | | | ±0.25pF | GRM1882C1H9R8CA01# | | | | | 2200pF | ±5% | GRM1887U1H222JA01# | |
| | | | | ±0.5pF | GRM1882C1H9R8DA01# | | | | | 2700pF | ±5% | GRM1887U1H272JA01# | |
| | | | 9.9pF | ±0.05pF | GRM1882C1H9R9WA01# | | | | | 3300pF | ±5% | GRM1887U1H332JA01# | |
| | | | | ±0.1pF | GRM1882C1H9R9BA01# | | | | | 3900pF | ±5% | GRM1887U1H392JA01# | |
| | | | | ±0.25pF | GRM1882C1H9R9CA01# | | | | | 4700pF | ±5% | GRM1887U1H472JA01# | |
| | | | | ±0.5pF | GRM1882C1H9R9DA01# | | | | | 5600pF | ±5% | GRM1887U1H562JA01# | |
| | | | 10pF | ±5% | GRM1882C1H100JA01# | | | | | 6800pF | ±5% | GRM1887U1H682JA01# | |
| | | | 12pF | ±5% | GRM1882C1H120JA01# | | | | | 8200pF | ±5% | GRM1887U1H822JA01# | |
| | | | 15pF | ±5% | GRM1882C1H150JA01# | | | | | 10000pF | ±5% | GRM1887U1H103JA01# | |
| | | | 18pF | ±5% | GRM1882C1H180JA01# | | | | | 1000pF | ±5% | GRM1883U1H102JA01# | |
| | | | 22pF | ±5% | GRM1882C1H220JA01# | | | | | 1200pF | ±5% | GRM1883U1H122JA01# | |
| | | | 27pF | ±5% | GRM1882C1H270JA01# | | | | | 1500pF | ±5% | GRM1883U1H152JA01# | |
| | | | 33pF | ±5% | GRM1882C1H330JA01# | | | | | 1800pF | ±5% | GRM1883U1H182JA01# | |
| | | | 39pF | ±5% | GRM1882C1H390JA01# | | | | | 2200pF | ±5% | GRM1883U1H222JA01# | |
| | | | 47pF | ±5% | GRM1882C1H470JA01# | | | | | 2700pF | ±5% | GRM1883U1H272JA01# | |
| | | | 56pF | ±5% | GRM1882C1H560JA01# | | | | | 3300pF | ±5% | GRM1883U1H332JA01# | |
| | | | 68pF | ±5% | GRM1882C1H680JA01# | | | | | 3900pF | ±5% | GRM1883U1H392JA01# | |
| | | | | | | | | | | 4700pF | ±5% | GRM1883U1H472JA01# | |

Part number # indicates the package specification code.

For General Purpose
GRM Series

Capacitor Array
GNM Series

Low ESL
LL□ Series

High-Q Type
GJM Series

High Frequency
GQM Series

Monolithic Microchip
GMA Series

For Bonding
GMD Series

Product Information

GRM Series Temperature Compensating Type Part Number List

(→ ■ 1.6x0.8mm)

| T max. | Rated Voltage | TC Code | Cap. | Tol. | Part Number |
|--------|---------------|---------|---------|--------------------|--------------------|
| 0.9mm | 50Vdc | UJ | 5600pF | ±5% | GRM1883U1H562JA01# |
| | | | 6800pF | ±5% | GRM1883U1H682JA01# |
| | | | 8200pF | ±5% | GRM1883U1H822JA01# |
| | | | 10000pF | ±5% | GRM1883U1H103JA01# |
| | 10Vdc | SL | 12000pF | ±5% | GRM1881X1A123JA01# |
| | | | 15000pF | ±5% | GRM1881X1A153JA01# |
| | | | 18000pF | ±5% | GRM1881X1A183JA01# |
| | | | 22000pF | ±5% | GRM1881X1A223JA01# |
| | | U2J | 12000pF | ±5% | GRM1887U1A123JA01# |
| | | | 15000pF | ±5% | GRM1887U1A153JA01# |
| | | | 18000pF | ±5% | GRM1887U1A183JA01# |
| | | | 22000pF | ±5% | GRM1887U1A223JA01# |
| | UJ | 12000pF | ±5% | GRM1883U1A123JA01# | |
| | | 15000pF | ±5% | GRM1883U1A153JA01# | |
| | | 18000pF | ±5% | GRM1883U1A183JA01# | |
| | | 22000pF | ±5% | GRM1883U1A223JA01# | |

| T max. | Rated Voltage | TC Code | Cap. | Tol. | Part Number | |
|---------|---------------|---------|--------------------|--------------------|--------------------|--------------------|
| 0.7mm | 100Vdc | CH | 1500pF | ±5% | GRM2162C2A152JA01# | |
| | | | 1800pF | ±5% | GRM2162C2A182JA01# | |
| | | | 2200pF | ±5% | GRM2162C2A222JA01# | |
| | | | 2700pF | ±5% | GRM2162C2A272JA01# | |
| | | | 3300pF | ±5% | GRM2162C2A332JA01# | |
| | | | 4700pF | ±5% | GRM2162C2A472JA01# | |
| | | 50Vdc | C0G | 1200pF | ±5% | GRM2165C1H122JA01# |
| | | | | 1500pF | ±5% | GRM2165C1H152JA01# |
| | | | | 1800pF | ±5% | GRM2165C1H182JA01# |
| | | | | 2200pF | ±5% | GRM2165C1H222JA01# |
| | | | | 2700pF | ±5% | GRM2165C1H272JA01# |
| | | | | 3300pF | ±5% | GRM2165C1H332JA01# |
| | 50Vdc | CH | 1200pF | ±5% | GRM2162C1H122JA01# | |
| | | | 1500pF | ±5% | GRM2162C1H152JA01# | |
| | | | 1800pF | ±5% | GRM2162C1H182JA01# | |
| | | | 2200pF | ±5% | GRM2162C1H222JA01# | |
| | | | 2700pF | ±5% | GRM2162C1H272JA01# | |
| | | | 3300pF | ±5% | GRM2162C1H332JA01# | |
| | | SL | 12000pF | ±5% | GRM2161X1H123JA01# | |
| | | | 15000pF | ±5% | GRM2161X1H153JA01# | |
| | | | 18000pF | ±5% | GRM2161X1H183JA01# | |
| | | | U2J | 12000pF | ±5% | GRM2167U1H123JA01# |
| | | | | 15000pF | ±5% | GRM2167U1H153JA01# |
| | | | | 18000pF | ±5% | GRM2167U1H183JA01# |
| UJ | 10000pF | ±5% | GRM2163U1H103JA01# | | | |
| | 12000pF | ±5% | GRM2163U1H123JA01# | | | |
| | 15000pF | ±5% | GRM2163U1H153JA01# | | | |
| 0.95mm | 50Vdc | C0G | 5600pF | ±5% | GRM2195C1H562JA01# | |
| | | | 6800pF | ±5% | GRM2195C1H682JA01# | |
| | | | 8200pF | ±5% | GRM2195C1H822JA01# | |
| | | | 10000pF | ±5% | GRM2195C1H103JA01# | |
| | | | 12000pF | ±5% | GRM2195C1H123JA01# | |
| | | | 15000pF | ±5% | GRM2195C1H153JA01# | |
| | 50Vdc | CH | 5600pF | ±5% | GRM2192C1H562JA01# | |
| | | | 6800pF | ±5% | GRM2192C1H682JA01# | |
| | | | 8200pF | ±5% | GRM2192C1H822JA01# | |
| | | | 10000pF | ±5% | GRM2192C1H103JA01# | |
| | | | 12000pF | ±5% | GRM2192C1H123JA01# | |
| | | | 15000pF | ±5% | GRM2192C1H153JA01# | |
| 50Vdc | SL | 22000pF | ±5% | GRM2191X1H223JA01# | | |
| | | 27000pF | ±5% | GRM2191X1H273JA01# | | |
| | | U2J | 22000pF | ±5% | GRM2197U1H223JA01# | |
| | 27000pF | | ±5% | GRM2197U1H273JA01# | | |
| | UJ | | 22000pF | ±5% | GRM2193U1H223JA01# | |
| | | 27000pF | ±5% | GRM2193U1H273JA01# | | |
| 10Vdc | | SL | 56000pF | ±5% | GRM2191X1A563JA01# | |
| | 68000pF | | ±5% | GRM2197U1A563JA01# | | |
| | 68000pF | | ±5% | GRM2193U1A563JA01# | | |
| | U2J | 56000pF | ±5% | GRM2197U1A563JA01# | | |
| | | UJ | 56000pF | ±5% | GRM2193U1A563JA01# | |
| | | | 1mm | 50Vdc | SL | 33000pF |
| 33000pF | ±5% | | | | | GRM21A7U1H333JA39# |

■ 2.0x1.25mm

| T max. | Rated Voltage | TC Code | Cap. | Tol. | Part Number | |
|--------|---------------|---------|--------|-------|--------------------|--------------------|
| 0.7mm | 100Vdc | C0G | 100pF | ±5% | GRM2165C2A101JA01# | |
| | | | 120pF | ±5% | GRM2165C2A121JA01# | |
| | | | 150pF | ±5% | GRM2165C2A151JA01# | |
| | | | 180pF | ±5% | GRM2165C2A181JA01# | |
| | | | 220pF | ±5% | GRM2165C2A221JA01# | |
| | | | 270pF | ±5% | GRM2165C2A271JA01# | |
| | | | 330pF | ±5% | GRM2165C2A331JA01# | |
| | | | 390pF | ±5% | GRM2165C2A391JA01# | |
| | | | 470pF | ±5% | GRM2165C2A471JA01# | |
| | | | 560pF | ±5% | GRM2165C2A561JA01# | |
| | | | 680pF | ±5% | GRM2165C2A681JA01# | |
| | | | 820pF | ±5% | GRM2165C2A821JA01# | |
| | | | 1000pF | ±5% | GRM2165C2A102JA01# | |
| | | | 1200pF | ±5% | GRM2165C2A122JA01# | |
| | | | 1500pF | ±5% | GRM2165C2A152JA01# | |
| | | | 1800pF | ±5% | GRM2165C2A182JA01# | |
| | | | 2200pF | ±5% | GRM2165C2A222JA01# | |
| | | | 2700pF | ±5% | GRM2165C2A272JA01# | |
| | | | 3300pF | ±5% | GRM2165C2A332JA01# | |
| | | | CH | 100pF | ±5% | GRM2162C2A101JA01# |
| | | | | 120pF | ±5% | GRM2162C2A121JA01# |
| | | | | 150pF | ±5% | GRM2162C2A151JA01# |
| | | | | 180pF | ±5% | GRM2162C2A181JA01# |
| | | | | 220pF | ±5% | GRM2162C2A221JA01# |
| | | 270pF | | ±5% | GRM2162C2A271JA01# | |
| | | 330pF | | ±5% | GRM2162C2A331JA01# | |
| | | 390pF | | ±5% | GRM2162C2A391JA01# | |
| | | 470pF | | ±5% | GRM2162C2A471JA01# | |
| | | 560pF | | ±5% | GRM2162C2A561JA01# | |
| | | 680pF | | ±5% | GRM2162C2A681JA01# | |
| | | 820pF | | ±5% | GRM2162C2A821JA01# | |
| | | 1000pF | | ±5% | GRM2162C2A102JA01# | |
| | | 1200pF | | ±5% | GRM2162C2A122JA01# | |

Part number # indicates the package specification code.

For General Purpose GRM Series
 Capacitor Array GNM Series
 Low ESL LLI Series
 High-Q Type GJM Series
 High Frequency GQM Series
 Monolithic Microchip GMA Series
 For Bonding GMD Series
 Product Information

GRM Series Temperature Compensating Type Part Number List

(→ ■ 2.0x1.25mm)

| T max. | Rated Voltage | TC Code | Cap. | Tol. | Part Number |
|--------|---------------|---------|--------|---------------------------|---------------------------|
| 1mm | 50Vdc | UJ | 3300pF | ±5% | GRM21A3U1H333JA39# |
| 1.35mm | 50Vdc | COG | 1800pF | ±5% | GRM21B5C1H183JA01# |
| | | | 2200pF | ±5% | GRM21B5C1H223JA01# |
| | | | 3900pF | ±5% | GRM21B5C1H393JA01# |
| | | CH | 1800pF | ±5% | GRM21B2C1H183JA01# |
| | | | 2200pF | ±5% | GRM21B2C1H223JA01# |
| | | | 3900pF | ±5% | GRM21B2C1H393JA01# |
| | | SL | 3900pF | ±5% | GRM21B1X1H393JA01# |
| | | | 4700pF | ±5% | GRM21B1X1H473JA01# |
| | | U2J | 3900pF | ±5% | GRM21B7U1H393JA01# |
| | 4700pF | | ±5% | GRM21B7U1H473JA01# | |
| | UJ | 3900pF | ±5% | GRM21B3U1H393JA01# | |
| | | 4700pF | ±5% | GRM21B3U1H473JA01# | |
| | 10Vdc | SL | 6800pF | ±5% | GRM21B1X1A683JA01# |
| | | | 8200pF | ±5% | GRM21B1X1A823JA01# |
| | | | 0.1μF | ±5% | GRM21B1X1A104JA01# |
| | | U2J | 6800pF | ±5% | GRM21B7U1A683JA01# |
| | | | 8200pF | ±5% | GRM21B7U1A823JA01# |
| | | | 0.1μF | ±5% | GRM21B7U1A104JA01# |
| UJ | | 6800pF | ±5% | GRM21B3U1A683JA01# | |
| | | 8200pF | ±5% | GRM21B3U1A823JA01# | |
| | | 0.1μF | ±5% | GRM21B3U1A104JA01# | |

■ 3.2x1.6mm

| T max. | Rated Voltage | TC Code | Cap. | Tol. | Part Number |
|--------|---------------|---------|---------------------------|---------------------------|---------------------------|
| 0.95mm | 100Vdc | COG | 1800pF | ±5% | GRM3195C2A182JA01# |
| | | | 2200pF | ±5% | GRM3195C2A222JA01# |
| | | | 2700pF | ±5% | GRM3195C2A272JA01# |
| | | | 3300pF | ±5% | GRM3195C2A332JA01# |
| | | | 3900pF | ±5% | GRM3195C2A392JA01# |
| | | | 4700pF | ±5% | GRM3195C2A472JA01# |
| | | | 5600pF | ±5% | GRM3195C2A562JA01# |
| | | | 6800pF | ±5% | GRM3195C2A682JA01# |
| | | | 8200pF | ±5% | GRM3195C2A822JA01# |
| | | | 10000pF | ±5% | GRM3195C2A103JA01# |
| | | | 12000pF | ±5% | GRM3195C2A123JA01# |
| | | | 15000pF | ±5% | GRM3195C2A153JA01# |
| | | | 18000pF | ±5% | GRM3195C2A183JA01# |
| | | | 22000pF | ±5% | GRM3195C2A223JA01# |
| | | | CH | 1800pF | ±5% |
| | | 2200pF | | ±5% | GRM3192C2A222JA01# |
| | | 2700pF | | ±5% | GRM3192C2A272JA01# |
| | | 3300pF | | ±5% | GRM3192C2A332JA01# |
| | | 3900pF | | ±5% | GRM3192C2A392JA01# |
| | | 4700pF | | ±5% | GRM3192C2A472JA01# |
| | | 5600pF | | ±5% | GRM3192C2A562JA01# |
| | | 6800pF | | ±5% | GRM3192C2A682JA01# |
| | | 8200pF | | ±5% | GRM3192C2A822JA01# |
| | | 10000pF | | ±5% | GRM3192C2A103JA01# |
| | | 12000pF | | ±5% | GRM3192C2A123JA01# |
| | | 15000pF | | ±5% | GRM3192C2A153JA01# |
| | | 18000pF | ±5% | GRM3192C2A183JA01# | |
| | 22000pF | ±5% | GRM3192C2A223JA01# | | |
| | 50Vdc | COG | 12000pF | ±5% | GRM3195C1H123JA01# |

| T max. | Rated Voltage | TC Code | Cap. | Tol. | Part Number | |
|--------|---------------|---------|--------|---------------------------|---------------------------|---------------------------|
| 0.95mm | 50Vdc | COG | 1500pF | ±5% | GRM3195C1H153JA01# | |
| | | | 1800pF | ±5% | GRM3195C1H183JA01# | |
| | | | 2200pF | ±5% | GRM3195C1H223JA01# | |
| | | | 2700pF | ±5% | GRM3195C1H273JA01# | |
| | | | 3300pF | ±5% | GRM3195C1H333JA01# | |
| | | | 3900pF | ±5% | GRM3195C1H393JA01# | |
| | | CH | 1200pF | ±5% | GRM3192C1H123JA01# | |
| | | | 1500pF | ±5% | GRM3192C1H153JA01# | |
| | | | 1800pF | ±5% | GRM3192C1H183JA01# | |
| | | | 2200pF | ±5% | GRM3192C1H223JA01# | |
| | | | 2700pF | ±5% | GRM3192C1H273JA01# | |
| | | SL | 3300pF | ±5% | GRM3192C1H333JA01# | |
| | | | 3900pF | ±5% | GRM3192C1H393JA01# | |
| | | | 5600pF | ±5% | GRM3191X1H563JA01# | |
| | | | 5600pF | ±5% | GRM3197U1H563JA01# | |
| | 5600pF | | ±5% | GRM3193U1H563JA01# | | |
| | 1.25mm | 50Vdc | COG | 4700pF | ±5% | GRM31M5C1H473JA01# |
| | | | | 5600pF | ±5% | GRM31M5C1H563JA01# |
| | | | | 6800pF | ±5% | GRM31M5C1H683JA01# |
| | | | CH | 4700pF | ±5% | GRM31M2C1H473JA01# |
| | | | | 5600pF | ±5% | GRM31M2C1H563JA01# |
| 6800pF | | | | ±5% | GRM31M2C1H683JA01# | |
| SL | | | 8200pF | ±5% | GRM31M1X1H823JA01# | |
| | | | 0.1μF | ±5% | GRM31M1X1H104JA01# | |
| | | | 6800pF | ±5% | GRM31M7U1H683JA01# | |
| U2J | | 8200pF | ±5% | GRM31M7U1H823JA01# | | |
| | | 0.1μF | ±5% | GRM31M7U1H104JA01# | | |
| | | 6800pF | ±5% | GRM31M3U1H683JA01# | | |
| UJ | | 8200pF | ±5% | GRM31M3U1H823JA01# | | |
| | | 0.1μF | ±5% | GRM31M3U1H104JA01# | | |
| | | 1.8mm | 50Vdc | COG | 6800pF | ±5% |
| 8200pF | ±5% | | | | GRM31C5C1H823JA01# | |
| 0.1μF | ±5% | | | | GRM31C5C1H104JA01# | |
| CH | 6800pF | | ±5% | GRM31C2C1H683JA01# | | |
| | 8200pF | | ±5% | GRM31C2C1H823JA01# | | |
| | 0.1μF | | ±5% | GRM31C2C1H104JA01# | | |

For General Purpose GRM Series
 Capacitor Array GNM Series
 Low ESL LLL Series
 High-Q Type GJM Series
 High Frequency GQM Series
 Monolithic Microchip GMA Series
 For Bonding GMD Series
 Product Information

Part number # indicates the package specification code.

GRM Series High Dielectric Constant Type Part Number List

■ 0.4x0.2mm **Ultra-compact**

| T max. | Rated Voltage | TC Code | Cap. | Tol. | Part Number | |
|--------|---------------|---------|--------------------|--------------------|--------------------|--------------------|
| 0.22mm | 10Vdc | X7R | 68pF | ±10% | GRM022R71A680KA01# | |
| | | | | ±20% | GRM022R71A680MA01# | |
| | | | 100pF | ±10% | GRM022R71A101KA01# | |
| | | | | ±20% | GRM022R71A101MA01# | |
| | | | 150pF | ±10% | GRM022R71A151KA01# | |
| | | | | ±20% | GRM022R71A151MA01# | |
| | | | 220pF | ±10% | GRM022R71A221KA01# | |
| | | | | ±20% | GRM022R71A221MA01# | |
| | | | 330pF | ±10% | GRM022R71A331KA01# | |
| | | | | ±20% | GRM022R71A331MA01# | |
| | | | 470pF | ±10% | GRM022R71A471KA01# | |
| | | | | ±20% | GRM022R71A471MA01# | |
| | | | X5R | 68pF | ±10% | GRM022R61A680KA01# |
| | | | | | ±20% | GRM022R61A680MA01# |
| | | | | 100pF | ±10% | GRM022R61A101KA01# |
| | | | | | ±20% | GRM022R61A101MA01# |
| | | | | 150pF | ±10% | GRM022R61A151KA01# |
| | | | | | ±20% | GRM022R61A151MA01# |
| | | | | 220pF | ±10% | GRM022R61A221KA01# |
| | | | | | ±20% | GRM022R61A221MA01# |
| | | | | 330pF | ±10% | GRM022R61A331KA01# |
| | | | | | ±20% | GRM022R61A331MA01# |
| | | | | 470pF | ±10% | GRM022R61A471KA01# |
| | | | | | ±20% | GRM022R61A471MA01# |
| | | 680pF | | ±10% | GRM022R61A681KE19# | |
| | | | | ±20% | GRM022R61A681ME19# | |
| | | 1000pF | | ±10% | GRM022R61A102KE19# | |
| | | | | ±20% | GRM022R61A102ME19# | |
| | | 1500pF | | ±10% | GRM022R61A152KE19# | |
| | | | | ±20% | GRM022R61A152ME19# | |
| | | 2200pF | | ±10% | GRM022R61A222KE19# | |
| | | | | ±20% | GRM022R61A222ME19# | |
| | | 3300pF | | ±10% | GRM022R61A332KE19# | |
| | | | | ±20% | GRM022R61A332ME19# | |
| | | 4700pF | | ±10% | GRM022R61A472KE19# | |
| | | | | ±20% | GRM022R61A472ME19# | |
| | | 6800pF | ±10% | GRM022R61A682KE19# | | |
| | | | ±20% | GRM022R61A682ME19# | | |
| | | 10000pF | ±10% | GRM022R61A103KE19# | | |
| | | | ±20% | GRM022R61A103ME19# | | |
| | | B | 68pF | ±10% | GRM022B11A680KA01# | |
| | | | | ±20% | GRM022B11A680MA01# | |
| | | | 100pF | ±10% | GRM022B11A101KA01# | |
| | | | | ±20% | GRM022B11A101MA01# | |
| | | | 150pF | ±10% | GRM022B11A151KA01# | |
| | | | | ±20% | GRM022B11A151MA01# | |
| | | | 220pF | ±10% | GRM022B11A221KA01# | |
| | | | | ±20% | GRM022B11A221MA01# | |
| 330pF | ±10% | | GRM022B11A331KA01# | | | |
| | ±20% | | GRM022B11A331MA01# | | | |
| 470pF | ±10% | | GRM022B11A471KA01# | | | |
| | ±20% | | GRM022B11A471MA01# | | | |

| T max. | Rated Voltage | TC Code | Cap. | Tol. | Part Number | | |
|--------|---------------|---------|---------|------|--------------------|------|--------------------|
| 0.22mm | 10Vdc | B | 680pF | ±10% | GRM022B31A681KE19# | | |
| | | | | ±20% | GRM022B31A681ME19# | | |
| | | | 1000pF | ±10% | GRM022B31A102KE19# | | |
| | | | | ±20% | GRM022B31A102ME19# | | |
| | | | 1500pF | ±10% | GRM022B31A152KE19# | | |
| | | | | ±20% | GRM022B31A152ME19# | | |
| | | | 2200pF | ±10% | GRM022B31A222KE19# | | |
| | | | | ±20% | GRM022B31A222ME19# | | |
| | | | 3300pF | ±10% | GRM022B31A332KE19# | | |
| | | | | ±20% | GRM022B31A332ME19# | | |
| | | | 4700pF | ±10% | GRM022B31A472KE19# | | |
| | | | | ±20% | GRM022B31A472ME19# | | |
| | | | 6800pF | ±10% | GRM022B31A682KE19# | | |
| | | | | ±20% | GRM022B31A682ME19# | | |
| | | | 10000pF | ±10% | GRM022B31A103KE19# | | |
| | | | | ±20% | GRM022B31A103ME19# | | |
| | | | 6.3Vdc | X5R | 680pF | ±20% | GRM022R60J681ME19# |
| | | | | | | ±20% | GRM022R60J102ME19# |
| | | | | | 1000pF | ±20% | GRM022R60J152ME19# |
| | | | | | | ±20% | GRM022R60J222ME19# |
| | | | | | 1500pF | ±20% | GRM022R60J332ME19# |
| | | | | | | ±20% | GRM022R60J472ME19# |
| | | | | | 2200pF | ±20% | GRM022R60J682ME19# |
| | | | | | | ±20% | GRM022R60J103ME19# |
| | 3300pF | ±20% | | | GRM022R60J153ME15# | | |
| | | ±20% | | | GRM022R60J223KE15# | | |
| | 4700pF | ±20% | | | GRM022R60J223ME15# | | |
| | | ±20% | | | GRM022R60J333ME15# | | |
| | 6800pF | ±20% | | | GRM022R60J473ME15# | | |
| | | ±20% | | | GRM022R60J683ME15# | | |
| | 10000pF | ±20% | | | GRM022R60J104ME15# | | |
| | | ±20% | | | GRM022B30J681ME19# | | |
| | 4Vdc | X5R | | | 15000pF | ±10% | GRM022R60G153KE15# |
| | | | | | | ±20% | GRM022R60G153ME15# |
| | | | | | 22000pF | ±10% | GRM022R60G223KE15# |
| | | | | | | ±20% | GRM022R60G223ME15# |
| | | | | | 33000pF | ±10% | GRM022R60G333KE15# |
| | | | | | | ±20% | GRM022R60G333ME15# |
| | | | | | 47000pF | ±10% | GRM022R60G473KE15# |
| | | | | | | ±20% | GRM022R60G473ME15# |
| | | | 68000pF | ±20% | GRM022R60G683ME15# | | |
| | | | | ±20% | GRM022R60G104ME15# | | |

Part number # indicates the package specification code.

For General Purpose GRM Series
 Capacitor Array GNM Series
 Low ESL LL Series
 High-Q Type GJM Series
 High Frequency GQM Series
 Monolithic Microchip GMA Series
 For Bonding GMD Series
 Product Information

GRM Series High Dielectric Constant Type Part Number List

■ 0.6×0.3mm Ultra-compact

| T max. | Rated Voltage | TC Code | Cap. | Tol. | Part Number | |
|--------|---------------|---------|--------|--------------------|--------------------|--------------------|
| 0.33mm | 50Vdc | X7R | 100pF | ±10% | GRM033R71H101KA12# | |
| | | | | ±20% | GRM033R71H101MA12# | |
| | | | 150pF | ±10% | GRM033R71H151KA12# | |
| | | | | ±20% | GRM033R71H151MA12# | |
| | | | 220pF | ±10% | GRM033R71H221KA12# | |
| | | | | ±20% | GRM033R71H221MA12# | |
| | | | 330pF | ±10% | GRM033R71H331KA12# | |
| | | | | ±20% | GRM033R71H331MA12# | |
| | | | 470pF | ±10% | GRM033R71H471KA12# | |
| | | | | ±20% | GRM033R71H471MA12# | |
| | | | 680pF | ±10% | GRM033R71H681KA12# | |
| | | | | ±20% | GRM033R71H681MA12# | |
| | | | 1000pF | ±10% | GRM033R71H102KA12# | |
| | | | | ±20% | GRM033R71H102MA12# | |
| | | | 1500pF | ±10% | GRM033R71H152KA12# | |
| | | | | ±20% | GRM033R71H152MA12# | |
| | | | B | 100pF | ±10% | GRM033B31H101KA12# |
| | | | | | ±20% | GRM033B31H101MA12# |
| | | | | 150pF | ±10% | GRM033B31H151KA12# |
| | | | | | ±20% | GRM033B31H151MA12# |
| | | | | 220pF | ±10% | GRM033B31H221KA12# |
| | | | | | ±20% | GRM033B31H221MA12# |
| | | | | 330pF | ±10% | GRM033B31H331KA12# |
| | | | | | ±20% | GRM033B31H331MA12# |
| | | 470pF | | ±10% | GRM033B31H471KA12# | |
| | | | | ±20% | GRM033B31H471MA12# | |
| | | 680pF | | ±10% | GRM033B31H681KA12# | |
| | | | | ±20% | GRM033B31H681MA12# | |
| | | 1000pF | ±10% | GRM033B31H102KA12# | | |
| | | | ±20% | GRM033B31H102MA12# | | |
| | | 1500pF | ±10% | GRM033B31H152KA12# | | |
| | | | ±20% | GRM033B31H152MA12# | | |
| | | 25Vdc | X7R | 100pF | ±10% | GRM033R71E101KA01# |
| | | | | | ±10% | GRM033R71E151KA01# |
| | | | | 220pF | ±10% | GRM033R71E221KA01# |
| | | | | | ±10% | GRM033R71E331KA01# |
| | | | | 470pF | ±10% | GRM033R71E471KA01# |
| | | | | | ±10% | GRM033R71E681KA01# |
| | | | | 1000pF | ±10% | GRM033R71E102KA01# |
| | | | | | ±10% | GRM033R71E152KA01# |
| | | | | 2200pF | ±10% | GRM033R71E222KA12# |
| | | | | | ±20% | GRM033R71E222MA12# |
| | | | | 3300pF | ±10% | GRM033R71E332KA12# |
| | | | | | ±20% | GRM033R71E332MA12# |
| | | | R | 100pF | ±10% | GRM033R11E101KA01# |
| | | | | | ±10% | GRM033R11E151KA01# |
| | | | | 220pF | ±10% | GRM033R11E221KA01# |
| | | | | | ±10% | GRM033R11E331KA01# |
| 470pF | ±10% | | | GRM033R11E471KA01# | | |
| | ±10% | | | GRM033R11E681KA01# | | |
| 1000pF | ±10% | | | GRM033R11E102KA01# | | |
| | ±10% | | | GRM033R11E152KA01# | | |
| 2200pF | ±10% | | | GRM033R11E222KA01# | | |
| | ±10% | | | GRM033R11E222MA01# | | |
| 3300pF | ±10% | | | GRM033R11E332KA01# | | |
| | ±10% | | | GRM033R11E332MA01# | | |

| T max. | Rated Voltage | TC Code | Cap. | Tol. | Part Number | | |
|--------|---------------|---------|--------------------|--------------------|--------------------|--------------------|--------------------|
| 0.33mm | 25Vdc | X5R | 100pF | ±10% | GRM033R61E101KA01# | | |
| | | | | ±10% | GRM033R61E151KA01# | | |
| | | | 220pF | ±10% | GRM033R61E221KA01# | | |
| | | | | ±10% | GRM033R61E331KA01# | | |
| | | | 470pF | ±10% | GRM033R61E471KA01# | | |
| | | | | ±10% | GRM033R61E681KA01# | | |
| | | | 1000pF | ±10% | GRM033R61E102KA01# | | |
| | | | | ±10% | GRM033R61E103KA12# | | |
| | | | 10000pF | ±10% | GRM033R61E103MA12# | | |
| | | | | ±20% | GRM033R61E103MA12# | | |
| | | | B | 100pF | ±10% | GRM033B11E101KA01# | |
| | | | | | ±10% | GRM033B11E151KA01# | |
| | | | | 220pF | ±10% | GRM033B11E221KA01# | |
| | | | | | ±10% | GRM033B11E331KA01# | |
| | | | | 470pF | ±10% | GRM033B11E471KA01# | |
| | | | | | ±10% | GRM033B11E681KA01# | |
| | | | | 1000pF | ±10% | GRM033B11E102KA01# | |
| | | | | | ±20% | GRM033B11E102MA01# | |
| | | | | 1500pF | ±10% | GRM033B11E152KA01# | |
| | | | | | ±20% | GRM033B11E152MA01# | |
| | | | | 2200pF | ±10% | GRM033B31E222KA12# | |
| | | | | | ±20% | GRM033B31E222MA12# | |
| | | | 3300pF | ±10% | GRM033B31E332KA12# | | |
| | | | | ±20% | GRM033B31E332MA12# | | |
| | | 10000pF | ±10% | GRM033B31E103KA12# | | | |
| | | | ±20% | GRM033B31E103MA12# | | | |
| | | 16Vdc | X7R | 2200pF | ±10% | GRM033R71C222KA88# | |
| | | | | | ±10% | GRM033R71C332KA88# | |
| | | | | R | 2200pF | ±10% | GRM033R11C222KA88# |
| | | | | | 3300pF | ±10% | GRM033R11C332KA88# |
| | | | X5R | 10000pF | ±10% | GRM033R61C103KA12# | |
| | | | | | ±20% | GRM033R61C103MA12# | |
| | | | | 0.1μF | ±10% | GRM033R61C104KE84# | |
| | | | | | ±20% | GRM033R61C104ME84# | |
| | | | B | 2200pF | ±10% | GRM033B31C222KA87# | |
| | | | | | ±20% | GRM033B31C222MA87# | |
| | | | | 3300pF | ±10% | GRM033B31C332KA87# | |
| | | | | | ±20% | GRM033B31C332MA87# | |
| | | 10000pF | | ±10% | GRM033B31C103KA12# | | |
| | | | | ±20% | GRM033B31C103MA12# | | |
| | | 0.1μF | | ±10% | GRM033B31C104KE84# | | |
| | | | | ±20% | GRM033B31C104ME84# | | |
| | | 10Vdc | X7R | 4700pF | ±10% | GRM033R71A472KA01# | |
| | | | | | ±20% | GRM033R71A472MA01# | |
| | | | | 6800pF | ±10% | GRM033R71A682KA01# | |
| | | | | | ±20% | GRM033R71A682MA01# | |
| | | | | 10000pF | ±10% | GRM033R71A103KA01# | |
| | | | | | ±20% | GRM033R71A103MA01# | |
| R | 4700pF | | ±10% | GRM033R11A472KA01# | | | |
| | | | ±20% | GRM033R11A472MA01# | | | |
| | 6800pF | | ±10% | GRM033R11A682KA01# | | | |
| | | | ±20% | GRM033R11A682MA01# | | | |
| | 10000pF | | ±10% | GRM033R11A103KA01# | | | |
| | | | ±20% | GRM033R11A103MA01# | | | |
| X5R | 4700pF | ±10% | GRM033R61A472KA01# | | | | |

Part number # indicates the package specification code.

For General Purpose GRM Series
 Capacitor Array GNM Series
 Low ESL LL□ Series
 High-Q Type GJM Series
 High Frequency GQM Series
 Monolithic Microchip GMA Series
 For Bonding GMD Series
 Product Information

GRM Series High Dielectric Constant Type Part Number List

(→ ■ 0.6x0.3mm)

| T max. | Rated Voltage | TC Code | Cap. | Tol. | Part Number | | |
|--------|---------------|---------|---------|--------|--------------------|--------------------|--|
| 0.33mm | 10Vdc | X5R | 4700pF | ±20% | GRM033R61A472MA01# | | |
| | | | | ±10% | GRM033R61A682KA01# | | |
| | | | 6800pF | ±20% | GRM033R61A682MA01# | | |
| | | | | ±10% | GRM033R61A103KA01# | | |
| | | | 10000pF | ±20% | GRM033R61A103MA01# | | |
| | | | | ±10% | GRM033R61A123KE84# | | |
| | | | 12000pF | ±20% | GRM033R61A123ME84# | | |
| | | | | ±10% | GRM033R61A153KE84# | | |
| | | | 15000pF | ±20% | GRM033R61A153ME84# | | |
| | | | | ±10% | GRM033R61A183KE84# | | |
| | | | 18000pF | ±20% | GRM033R61A183ME84# | | |
| | | | | ±10% | GRM033R61A223KE84# | | |
| | | | 22000pF | ±20% | GRM033R61A223ME84# | | |
| | | | | ±10% | GRM033R61A273KE84# | | |
| | | | 27000pF | ±20% | GRM033R61A273ME84# | | |
| | | | | ±10% | GRM033R61A333KE84# | | |
| | | | 33000pF | ±20% | GRM033R61A333ME84# | | |
| | | | | ±10% | GRM033R61A393KE84# | | |
| | | | 39000pF | ±20% | GRM033R61A393ME84# | | |
| | | | | ±10% | GRM033R61A473KE84# | | |
| | | | 47000pF | ±20% | GRM033R61A473ME84# | | |
| | | | | ±10% | GRM033R61A683KE84# | | |
| | | | 68000pF | ±20% | GRM033R61A683ME84# | | |
| | | | | ±10% | GRM033R61A104KE84# | | |
| | | | 0.1µF | ±20% | GRM033R61A104ME84# | | |
| | | | | ±20% | GRM033R61A224ME90# | Derating | |
| | | | B | 4700pF | ±10% | GRM033B11A472KA01# | |
| | | | | | ±20% | GRM033B11A472MA01# | |
| | | | 6800pF | ±10% | GRM033B11A682KA01# | | |
| | | | | ±20% | GRM033B11A682MA01# | | |
| | | | 10000pF | ±10% | GRM033B11A103KA01# | | |
| | | | | ±20% | GRM033B11A103MA01# | | |
| | | | 12000pF | ±10% | GRM033B31A123KE84# | | |
| | | | | ±20% | GRM033B31A123ME84# | | |
| | | | 15000pF | ±10% | GRM033B31A153KE84# | | |
| | | | | ±20% | GRM033B31A153ME84# | | |
| | | | 18000pF | ±10% | GRM033B31A183KE84# | | |
| | | | | ±20% | GRM033B31A183ME84# | | |
| | | | 22000pF | ±10% | GRM033B31A223KE84# | | |
| | | | | ±20% | GRM033B31A223ME84# | | |
| | | | 27000pF | ±10% | GRM033B31A273KE84# | | |
| | | | | ±20% | GRM033B31A273ME84# | | |
| | | | 33000pF | ±10% | GRM033B31A333KE84# | | |
| | | | | ±20% | GRM033B31A333ME84# | | |
| | | | 39000pF | ±10% | GRM033B31A393KE84# | | |
| | | | | ±20% | GRM033B31A393ME84# | | |
| | | | 47000pF | ±10% | GRM033B31A473KE84# | | |
| | | | | ±20% | GRM033B31A473ME84# | | |
| | | | 68000pF | ±10% | GRM033B31A683KE84# | | |
| | | | | ±20% | GRM033B31A683ME84# | | |
| | | | 0.1µF | ±10% | GRM033B31A104KE84# | | |
| | | | | ±20% | GRM033B31A104ME84# | | |
| | | 6.3Vdc | X7R | 4700pF | ±10% | GRM033R70J472KA01# | |
| | | | | | ±10% | GRM033R70J682KA01# | |

| T max. | Rated Voltage | TC Code | Cap. | Tol. | Part Number | | | |
|--------|---------------|---------|---------|--------------------|--------------------|--------------------|--------------------|--|
| 0.33mm | 6.3Vdc | X7R | 10000pF | ±10% | GRM033R70J103KA01# | | | |
| | | | | R | 4700pF | ±10% | GRM033R10J472KA01# | |
| | | | | | 6800pF | ±10% | GRM033R10J682KA01# | |
| | | | X6S | 10000pF | ±10% | GRM033R10J103KA01# | | |
| | | | | 15000pF | ±10% | GRM033C80J153KE01# | | |
| | | | ±20% | | GRM033C80J153ME01# | | | |
| | | | 22000pF | ±10% | GRM033C80J223KE01# | | | |
| | | | | ±20% | GRM033C80J223ME01# | | | |
| | | | 33000pF | ±10% | GRM033C80J333KE01# | | | |
| | | | | ±20% | GRM033C80J333ME01# | | | |
| | | | 47000pF | ±10% | GRM033C80J473KE19# | | | |
| | | | | ±20% | GRM033C80J473ME19# | | | |
| | | 68000pF | ±10% | GRM033C80J683KE84# | Derating | | | |
| | | | ±20% | GRM033C80J683ME84# | Derating | | | |
| | | 0.1µF | ±10% | GRM033C80J104KE84# | Derating | | | |
| | | | ±20% | GRM033C80J104ME84# | Derating | | | |
| | | 0.22µF | ±20% | GRM033C80J224ME90# | Derating | | | |
| | | | X5R | 10000pF | ±10% | GRM033R60J103KA01# | | |
| | | ±10% | | | GRM033R60J153KE01# | | | |
| | | ±20% | | GRM033R60J153ME01# | | | | |
| | | 22000pF | ±10% | GRM033R60J223KE01# | | | | |
| | | | ±20% | GRM033R60J223ME01# | | | | |
| | | 33000pF | ±10% | GRM033R60J333KE01# | | | | |
| | | | ±20% | GRM033R60J333ME01# | | | | |
| | | 47000pF | ±10% | GRM033R60J473KE19# | | | | |
| | | | ±20% | GRM033R60J473ME19# | | | | |
| | | 0.22µF | ±20% | GRM033R60J224ME90# | | | | |
| | | | B | 4700pF | ±10% | GRM033B10J472KA01# | | |
| | | ±10% | | | GRM033B10J682KA01# | | | |
| | | 10000pF | ±10% | GRM033B10J103KA01# | | | | |
| | | | ±10% | GRM033B10J153KE01# | | | | |
| | | 15000pF | ±20% | GRM033B10J153ME01# | | | | |
| | | | ±10% | GRM033B10J223KE01# | | | | |
| | | 22000pF | ±20% | GRM033B10J223ME01# | | | | |
| | | | ±10% | GRM033B10J333KE01# | | | | |
| | | 33000pF | ±20% | GRM033B10J333ME01# | | | | |
| | | | ±10% | GRM033B30J473KE18# | | | | |
| | | 47000pF | ±20% | GRM033B30J473ME18# | | | | |
| | | | 4Vdc | X6S | 0.22µF | ±20% | GRM033C80G224ME90# | |

■ 1.0x0.5mm

| T max. | Rated Voltage | TC Code | Cap. | Tol. | Part Number | | |
|--------|---------------|---------|--------------------|----------|--------------------|--------------------|--------------------|
| 0.22mm | 10Vdc | X5R | 0.1µF | ±10% | GRM152R61A104KE19# | Derating | |
| | | | | ±20% | GRM152R61A104ME19# | Derating | |
| | | | | ±10% | GRM152R61A224KE19# | Derating | |
| | | | 0.22µF | ±20% | GRM152R61A224ME19# | Derating | |
| | | | | B | 0.1µF | ±10% | GRM152B31A104KE19# |
| | | | ±20% | | | GRM152B31A104ME19# | Derating |
| | | 0.22µF | ±10% | | GRM152B31A224KE19# | Derating | |
| | | ±20% | GRM152B31A224ME19# | Derating | | | |
| | | 6.3Vdc | X6S | 0.1µF | ±10% | GRM152C80J104KE19# | Derating |
| | | | | | ±20% | GRM152C80J104ME19# | Derating |

Part number # indicates the package specification code.

GRM Series High Dielectric Constant Type Part Number List

(→ ■ 1.0×0.5mm)

| T max. | Rated Voltage | TC Code | Cap. | Tol. | Part Number | | |
|--------|--------------------|--------------------|--------------------|--------------------|--------------------|--------------------|----------|
| 0.22mm | 6.3Vdc | X6S | 0.22μF | ±10% | GRM152C80J224KE19# | Derating | |
| | | | | ±20% | GRM152C80J224ME19# | Derating | |
| | | | X5R | 0.1μF | ±10% | GRM152R60J104KE19# | |
| | | | | | ±20% | GRM152R60J104ME19# | |
| | | | | 0.22μF | ±10% | GRM152R60J224KE19# | |
| | | ±20% | GRM152R60J224ME19# | | | | |
| | | 0.47μF | ±20% | GRM152R60J474ME15# | Derating | | |
| | | B | 0.1μF | ±10% | GRM152B30J104KE19# | | |
| | | | | ±20% | GRM152B30J104ME19# | | |
| | | | 0.22μF | ±10% | GRM152B30J224KE19# | | |
| | ±20% | | | GRM152B30J224ME19# | | | |
| | 0.47μF | | ±20% | GRM152B30J474ME15# | Derating | | |
| | 4Vdc | X7T | 0.1μF | ±10% | GRM152D70G104KE15# | Derating | |
| | | | | ±20% | GRM152D70G104ME15# | Derating | |
| | | | 0.22μF | ±10% | GRM152D70G224KE15# | Derating | |
| | | | | ±20% | GRM152D70G224ME15# | Derating | |
| | | | X6S | 0.1μF | ±10% | GRM152C80G104KE19# | |
| | | ±20% | | | GRM152C80G104ME19# | | |
| | | 0.22μF | | ±10% | GRM152C80G224KE19# | | |
| | | ±20% | GRM152C80G224ME19# | | | | |
| X6T | | 0.47μF | ±20% | GRM152D80G474ME15# | | | |
| 2.5Vdc | | X7T | 0.1μF | ±10% | GRM152D70E104KE19# | | |
| | ±20% | | | GRM152D70E104ME19# | | | |
| | 0.22μF | | ±10% | GRM152D70E224KE19# | | | |
| | | | ±20% | GRM152D70E224ME19# | | | |
| 0.3mm | 50Vdc | X7R | 220pF | ±10% | GRM15XR71H221KA86# | | |
| | | | | ±20% | GRM15XR71H221MA86# | | |
| | | | 330pF | ±10% | GRM15XR71H331KA86# | | |
| | | | | ±20% | GRM15XR71H331MA86# | | |
| | | | 470pF | ±10% | GRM15XR71H471KA86# | | |
| | | ±20% | GRM15XR71H471MA86# | | | | |
| | | 680pF | ±10% | GRM15XR71H681KA86# | | | |
| | | ±20% | GRM15XR71H681MA86# | | | | |
| | | 1000pF | ±10% | GRM15XR71H102KA86# | | | |
| | | ±20% | GRM15XR71H102MA86# | | | | |
| | | 1500pF | ±10% | GRM15XR71H152KA86# | | | |
| | | ±20% | GRM15XR71H152MA86# | | | | |
| | | R | 220pF | ±10% | GRM15XR11H221KA86# | | |
| | | | | ±20% | GRM15XR11H221MA86# | | |
| | | | 330pF | ±10% | GRM15XR11H331KA86# | | |
| | ±20% | | | GRM15XR11H331MA86# | | | |
| | 470pF | | ±10% | GRM15XR11H471KA86# | | | |
| | ±20% | GRM15XR11H471MA86# | | | | | |
| | 680pF | ±10% | GRM15XR11H681KA86# | | | | |
| | ±20% | GRM15XR11H681MA86# | | | | | |
| | 1000pF | ±10% | GRM15XR11H102KA86# | | | | |
| | ±20% | GRM15XR11H102MA86# | | | | | |
| | 1500pF | ±10% | GRM15XR11H152KA86# | | | | |
| | ±20% | GRM15XR11H152MA86# | | | | | |
| | B | 220pF | ±10% | GRM15XB11H221KA86# | | | |
| | | | ±20% | GRM15XB11H221MA86# | | | |
| | | 330pF | ±10% | GRM15XB11H331KA86# | | | |
| | | | ±20% | GRM15XB11H331MA86# | | | |
| | | 470pF | ±10% | GRM15XB11H471KA86# | | | |
| | ±20% | | GRM15XB11H471MA86# | | | | |
| | 680pF | ±10% | GRM15XB11H681KA86# | | | | |
| | ±20% | GRM15XB11H681MA86# | | | | | |
| | 1000pF | ±10% | GRM15XB11H102KA86# | | | | |
| ±20% | GRM15XB11H102MA86# | | | | | | |
| 1500pF | ±10% | GRM15XB11H152KA86# | | | | | |
| ±20% | GRM15XB11H152MA86# | | | | | | |
| 25Vdc | X7R | 2200pF | ±10% | GRM15XR71E222KA86# | | | |
| | | | ±20% | GRM15XR71E222MA86# | | | |
| | B | 2200pF | ±10% | GRM15XB11E222KA86# | | | |
| | | | ±20% | GRM15XB11E222MA86# | | | |
| 16Vdc | X7R | 3300pF | ±10% | GRM15XR71C332KA86# | | | |
| | | | ±20% | GRM15XR71C332MA86# | | | |
| | | | ±20% | GRM15XR71C332ME19# | | | |
| 0.3mm | 16Vdc | X7R | 3300pF | ±20% | GRM15XR71C332MA86# | | |
| | | | | ±10% | GRM15XR71C472KA86# | | |
| | | | 4700pF | ±10% | GRM15XR71C472MA86# | | |
| | | | | ±20% | GRM15XR71C472ME19# | | |
| | | | 6800pF | ±10% | GRM15XR71C682KA86# | | |
| | | | | ±20% | GRM15XR71C682MA86# | | |
| | | | 10000pF | ±10% | GRM15XR71C103KA86# | | |
| | | | | ±20% | GRM15XR71C103MA86# | | |
| | | | B | 3300pF | ±10% | GRM15XB11C332KA86# | |
| | | | | | ±20% | GRM15XB11C332MA86# | |
| | | 4700pF | | ±10% | GRM15XB11C472KA86# | | |
| | | | | ±20% | GRM15XB11C472MA86# | | |
| | | 6800pF | | ±10% | GRM15XB11C682KA86# | | |
| | | | | ±20% | GRM15XB11C682MA86# | | |
| | | 10000pF | | ±10% | GRM15XB11C103KA86# | | |
| | | | | ±20% | GRM15XB11C103MA86# | | |
| | | 10Vdc | X5R | 15000pF | ±10% | GRM15XR61A153KA86# | |
| | | | | | ±20% | GRM15XR61A153MA86# | |
| | 22000pF | | | ±10% | GRM15XR61A223KA86# | | |
| | | | | ±20% | GRM15XR61A223MA86# | | |
| | 33000pF | | | ±10% | GRM15XR61A333KA86# | | |
| | | | ±20% | GRM15XR61A333MA86# | | | |
| | | | ±20% | GRM15XR61A333ME19# | | | |
| | 10Vdc | | X5R | 1.0μF | ±20% | GRM153R61A105ME95# | Derating |
| | | | | | ±10% | GRM153R61A105MA95# | Derating |
| | | | B | 1.0μF | ±20% | GRM153B31A105ME95# | Derating |
| | | ±10% | | | GRM153B31A105MA95# | Derating | |
| | | 1.0μF | | ±20% | GRM153D80J105ME95# | Derating | |
| | | X6T | 1.0μF | ±20% | GRM153R60J105ME95# | | |
| | | | | ±10% | GRM153R60J105MA95# | | |
| | | | X5R | 1.0μF | ±20% | GRM153B30J105ME95# | |
| | | | | | ±10% | GRM153B30J105MA95# | |
| | 4Vdc | X6T | 1.0μF | ±20% | GRM153D80G105ME95# | | |
| ±10% | | | | GRM153D80G105MA95# | | | |
| 0.55mm | 100Vdc | X7R | 220pF | ±10% | GRM155R72A221KA01# | | |
| | | | | ±20% | GRM155R72A221MA01# | | |
| | | | 330pF | ±10% | GRM155R72A331KA01# | | |
| | | | | ±20% | GRM155R72A331MA01# | | |
| | | | 470pF | ±10% | GRM155R72A471KA01# | | |
| | | ±20% | GRM155R72A471MA01# | | | | |
| | | 680pF | ±10% | GRM155R72A681KA01# | | | |
| | | ±20% | GRM155R72A681MA01# | | | | |
| | | 1000pF | ±10% | GRM155R72A102KA01# | | | |
| | | ±20% | GRM155R72A102MA01# | | | | |
| | 1500pF | ±10% | GRM155R72A152KA01# | | | | |
| | ±20% | GRM155R72A152MA01# | | | | | |
| | 50Vdc | X7R | 220pF | ±10% | GRM155R71H221KA01# | | |
| | | | | ±20% | GRM155R71H221MA01# | | |
| | | 330pF | ±10% | GRM155R71H331KA01# | | | |
| ±20% | | | GRM155R71H331MA01# | | | | |
| 470pF | | ±10% | GRM155R71H471KA01# | | | | |
| ±20% | GRM155R71H471MA01# | | | | | | |
| 680pF | ±10% | GRM155R71H681KA01# | | | | | |
| ±20% | GRM155R71H681MA01# | | | | | | |
| 1000pF | ±10% | GRM155R71H102KA01# | | | | | |
| ±20% | GRM155R71H102MA01# | | | | | | |
| 50Vdc | X7R | 2200pF | ±10% | GRM155R71H222KA01# | | | |
| | | | ±20% | GRM155R71H222MA01# | | | |
| | | 3300pF | ±10% | GRM155R71H332KA01# | | | |
| | | | ±20% | GRM155R71H332MA01# | | | |
| | | 4700pF | ±10% | GRM155R71H472KA01# | | | |
| | ±20% | | GRM155R71H472MA01# | | | | |
| | ±20% | | GRM155R71H472ME19# | | | | |
| | X7S | 33000pF | ±10% | GRM155C71H333KE19# | | | |
| | | | ±20% | GRM155C71H333ME19# | | | |
| | | 0.1μF | ±10% | GRM155R71H104KE14# | | | |
| ±20% | | | GRM155R71H104ME14# | | | | |
| ±20% | | | GRM155C71H333KE19# | | | | |

Part number # indicates the package specification code.

GRM Series High Dielectric Constant Type Part Number List

(→ ■ 1.0x0.5mm)

| T max. | Rated Voltage | TC Code | Cap. | Tol. | Part Number | | |
|--------|---------------|---------|---------|--------------------|--------------------|--------------------|--|
| 0.55mm | 50Vdc | X7S | 47000pF | ±10% | GRM155C71H473KE19# | | |
| | | | | ±20% | GRM155C71H473ME19# | | |
| | | | 68000pF | ±10% | GRM155C71H683KE19# | | |
| | | | | ±20% | GRM155C71H683ME19# | | |
| | | | R | 220pF | ±10% | GRM155R11H221KA01# | |
| | | | | 330pF | ±10% | GRM155R11H331KA01# | |
| | | 470pF | | ±10% | GRM155R11H471KA01# | | |
| | | 680pF | | ±10% | GRM155R11H681KA01# | | |
| | | 1000pF | | ±10% | GRM155R11H102KA01# | | |
| | | 1500pF | | ±10% | GRM155R11H152KA01# | | |
| | | 2200pF | | ±10% | GRM155R11H222KA01# | | |
| | | 3300pF | | ±10% | GRM155R11H332KA01# | | |
| | | 4700pF | | ±10% | GRM155R11H472KA01# | | |
| | | 6800pF | | ±10% | GRM155R11H682KA88# | | |
| | | 10000pF | | ±10% | GRM155R11H103KA88# | | |
| | | X6S | | 0.1μF | ±10% | GRM155C81H104KE14# | |
| | | | ±20% | | GRM155C81H104ME14# | | |
| | | X5R | 1000pF | ±10% | GRM155R61H102KA01# | | |
| | | | 2200pF | ±10% | GRM155R61H222KA01# | | |
| | | | 4700pF | ±10% | GRM155R61H472KA01# | | |
| | | | | ±20% | GRM155R61H333ME19# | | |
| | | | 47000pF | ±10% | GRM155R61H473KE19# | | |
| | | | | ±20% | GRM155R61H473ME19# | | |
| | | | 68000pF | ±10% | GRM155R61H683KE19# | | |
| | | | | ±20% | GRM155R61H683ME19# | | |
| | | | 0.1μF | ±10% | GRM155R61H104KE14# | | |
| | | | | ±20% | GRM155R61H104ME14# | | |
| | | | B | 220pF | ±10% | GRM155B11H221KA01# | |
| | | | | | ±20% | GRM155B11H221MA01# | |
| | | 330pF | | ±10% | GRM155B11H331KA01# | | |
| | | | | ±20% | GRM155B11H331MA01# | | |
| | | 470pF | | ±10% | GRM155B11H471KA01# | | |
| | | | | ±20% | GRM155B11H471MA01# | | |
| | | 680pF | | ±10% | GRM155B11H681KA01# | | |
| | | | | ±20% | GRM155B11H681MA01# | | |
| | | 1000pF | | ±10% | GRM155B11H102KA01# | | |
| | | | | ±20% | GRM155B11H102MA01# | | |
| | | 1500pF | | ±10% | GRM155B11H152KA01# | | |
| | | | | ±20% | GRM155B11H152MA01# | | |
| | | 2200pF | | ±10% | GRM155B11H222KA01# | | |
| | | | | ±20% | GRM155B11H222MA01# | | |
| | | 3300pF | | ±10% | GRM155B11H332KA01# | | |
| | | | | ±20% | GRM155B11H332MA01# | | |
| | | 4700pF | | ±10% | GRM155B11H472KA01# | | |
| | | | | ±20% | GRM155B11H472MA01# | | |
| | | 6800pF | | ±10% | GRM155B31H682KA88# | | |
| | | | | ±20% | GRM155B31H682MA88# | | |
| | | 10000pF | ±10% | GRM155B31H103KA88# | | | |
| | | | ±20% | GRM155B31H103MA88# | | | |
| | | 15000pF | ±10% | GRM155B31H153KA12# | | | |
| | | | ±20% | GRM155B31H153MA12# | | | |
| | | 22000pF | ±10% | GRM155B31H223KA12# | | | |
| | | | ±20% | GRM155B31H223MA12# | | | |

| T max. | Rated Voltage | TC Code | Cap. | Tol. | Part Number | |
|--------|---------------|---------|--------------------|--------------------|--------------------|--------------------|
| 0.55mm | 50Vdc | B | 0.1μF | ±10% | GRM155B31H104KE14# | |
| | | | | ±20% | GRM155B31H104ME14# | |
| | | | 6800pF | ±10% | GRM155R71E682KA01# | |
| | | | | ±10% | GRM155R71E103KA01# | |
| | | | 15000pF | ±10% | GRM155R71E153KA61# | |
| | | | 22000pF | ±10% | GRM155R71E223KA61# | |
| | | 33000pF | ±10% | GRM155R71E333KA88# | | |
| | | 47000pF | ±10% | GRM155R71E473KA88# | | |
| | | | 0.1μF | ±10% | GRM155R71E104KE14# | |
| | | | ±20% | GRM155R71E104ME14# | | |
| | | R | 6800pF | ±10% | GRM155R11E682KA01# | |
| | | | 10000pF | ±10% | GRM155R11E103KA01# | |
| | | | 15000pF | ±10% | GRM155R11E153KA61# | |
| | | | 22000pF | ±10% | GRM155R11E223KA61# | |
| | | | 33000pF | ±10% | GRM155R11E333KA88# | |
| | | | 47000pF | ±10% | GRM155R11E473KA88# | |
| | | X6S | 68000pF | ±10% | GRM155C81E683KA12# | |
| | | | | 0.1μF | ±10% | GRM155C81E104KA12# |
| | | | ±20% | GRM155C81E104MA12# | | |
| | X5R | | 68000pF | ±10% | GRM155R61E683KA87# | |
| | | | | ±20% | GRM155R61E683MA87# | |
| | 0.1μF | | ±10% | GRM155R61E104KA87# | | |
| | | ±20% | GRM155R61E104MA87# | | | |
| | 1.0μF | ±10% | GRM155R61E105KA12# | Derating | | |
| | | ±20% | GRM155R61E105MA12# | Derating | | |
| | B | 4700pF | ±10% | GRM155B11E472KA01# | | |
| | | | ±10% | GRM155B11E682KA01# | | |
| | | | ±10% | GRM155B11E103KA01# | | |
| | | | ±20% | GRM155B11E103MA01# | | |
| | | | ±10% | GRM155B11E153KA61# | | |
| | | | ±20% | GRM155B11E153MA61# | | |
| | | 22000pF | ±10% | GRM155B11E223KA61# | | |
| | | | ±20% | GRM155B11E223MA61# | | |
| | | 33000pF | ±10% | GRM155B31E333KA87# | | |
| | | | ±20% | GRM155B31E333MA87# | | |
| | | 47000pF | ±10% | GRM155B31E473KA87# | | |
| | | | ±20% | GRM155B31E473MA87# | | |
| | | 68000pF | ±10% | GRM155B31E683KA87# | | |
| | | | ±20% | GRM155B31E683MA87# | | |
| | | 0.1μF | ±10% | GRM155B31E104KA87# | | |
| | | | ±20% | GRM155B31E104MA87# | | |
| | | 1.0μF | ±10% | GRM155B31E105KA12# | Derating | |
| | | | ±20% | GRM155B31E105MA12# | Derating | |
| | 16Vdc | X7R | 33000pF | ±10% | GRM155R71C333KA01# | |
| | | | | ±10% | GRM155R71C473KA01# | |
| | | | 68000pF | ±10% | GRM155R71C683KA88# | |
| | | | | 0.15μF | ±10% | GRM155R71C154KA12# |
| | | | 0.22μF | ±10% | GRM155R71C224KA12# | |
| | | | R | 33000pF | ±10% | GRM155R11C333KA01# |
| | | 47000pF | | ±10% | GRM155R11C473KA01# | |
| | | 68000pF | ±10% | GRM155R11C683KA88# | | |
| | | | X5R | 33000pF | ±10% | GRM155R61C333KA01# |
| | | 47000pF | ±10% | GRM155R61C473KA01# | | |
| | | 68000pF | ±10% | GRM155R61C683KA88# | | |

Part number # indicates the package specification code.

GRM Series High Dielectric Constant Type Part Number List

(→ ■ 1.0x0.5mm)

| T max. | Rated Voltage | TC Code | Cap. | Tol. | Part Number | | | |
|--------|---------------|---------------------------|---------------------------|---------------------------|---------------------------|---------------------------|---------------------------|--|
| 0.55mm | 16Vdc | X5R | 1.0µF | ±10% | GRM155R61C105KA12# | | | |
| | | | | ±20% | GRM155R61C105MA12# | | | |
| | | | B | 33000pF | ±10% | GRM155B11C333KA01# | | |
| | | | | 47000pF | ±10% | GRM155B11C473KA01# | | |
| | | | | 68000pF | ±10% | GRM155B31C683KA87# | | |
| | | 1.0µF | ±10% | GRM155B31C105KA12# | | | | |
| | | | ±20% | GRM155B31C105MA12# | | | | |
| | | | 10Vdc | X7R | 68000pF | ±10% | GRM155R71A683KA01# | |
| | | | | | | ±20% | GRM155R71A683MA01# | |
| | | | | R | 68000pF | ±10% | GRM155R11A683KA01# | |
| | ±20% | GRM155R11A683MA01# | | | | | | |
| | X6S | 1.0µF | | ±10% | GRM155C81A105KA12# | | | |
| | | | | ±20% | GRM155C81A105MA12# | | | |
| | X5R | 0.15µF | | ±10% | GRM155R61A154KE19# | | | |
| | | | | ±20% | GRM155R61A154ME19# | | | |
| | | 0.22µF | | ±10% | GRM155R61A224KE19# | | | |
| | | | | ±20% | GRM155R61A224ME19# | | | |
| | | 0.33µF | ±10% | GRM155R61A334KE15# | | | | |
| | | | ±20% | GRM155R61A334ME15# | | | | |
| | | 0.47µF | ±10% | GRM155R61A474KE15# | | | | |
| | | | ±20% | GRM155R61A474ME15# | | | | |
| | | 0.68µF | ±10% | GRM155R61A684KE15# | | | | |
| | | | ±20% | GRM155R61A684ME15# | | | | |
| | 2.2µF | ±10% | GRM155R61A225KE95# | Degrating | | | | |
| | | ±20% | GRM155R61A225ME95# | Degrating | | | | |
| | B | 0.15µF | ±10% | GRM155B31A154KE18# | | | | |
| | | | ±20% | GRM155B31A154ME18# | | | | |
| | | 0.22µF | ±10% | GRM155B31A224KE18# | | | | |
| | | | ±20% | GRM155B31A224ME18# | | | | |
| | | 0.33µF | ±10% | GRM155B31A334KE14# | | | | |
| | | | ±20% | GRM155B31A334ME14# | | | | |
| | | 0.47µF | ±10% | GRM155B31A474KE14# | | | | |
| | | | ±20% | GRM155B31A474ME14# | | | | |
| | | 0.68µF | ±10% | GRM155B31A684KE15# | | | | |
| | | | ±20% | GRM155B31A684ME15# | | | | |
| | 2.2µF | ±10% | GRM155B31A225KE95# | Degrating | | | | |
| | | ±20% | GRM155B31A225ME95# | Degrating | | | | |
| | 6.3Vdc | X7R | 1.0µF | ±10% | GRM155R70J105KA12# | Degrating | | |
| | | | | ±20% | GRM155R70J105MA12# | Degrating | | |
| | | | X6S | 0.15µF | ±10% | GRM155C80J154KE01# | | |
| | | | | | ±20% | GRM155C80J154ME01# | | |
| | | | | 0.22µF | ±10% | GRM155C80J224KE01# | | |
| | | ±20% | | | GRM155C80J224ME01# | | | |
| | | 0.33µF | | ±10% | GRM155C80J334KE01# | | | |
| | | | | ±20% | GRM155C80J334ME01# | | | |
| 0.47µF | | ±10% | | GRM155C80J474KE19# | | | | |
| | | ±20% | | GRM155C80J474ME19# | | | | |
| 2.2µF | | ±10% | | GRM155C80J225KE95# | Degrating | | | |
| | | ±20% | | GRM155C80J225ME95# | Degrating | | | |
| X5R | | 0.15µF | ±10% | GRM155R60J154KE01# | | | | |
| | | | ±20% | GRM155R60J154ME01# | | | | |
| | | 0.22µF | ±10% | GRM155R60J224KE01# | | | | |
| | | | ±20% | GRM155R60J224ME01# | | | | |
| | | 0.33µF | ±10% | GRM155R60J334KE01# | | | | |

| T max. | Rated Voltage | TC Code | Cap. | Tol. | Part Number | | |
|--------|---------------|---------|---------------------------|---------------------------|---------------------------|---------------------------|------------------|
| 0.55mm | 6.3Vdc | X5R | 0.33µF | ±20% | GRM155R60J334ME01# | | |
| | | | | ±10% | GRM155R60J474KE19# | | |
| | | | 0.47µF | ±10% | GRM155R60J474ME19# | | |
| | | | | ±20% | GRM155R60J474ME19# | | |
| | | | 0.68µF | ±10% | GRM155R60J684KE19# | | |
| | | | | ±20% | GRM155R60J684ME19# | | |
| | | | 2.2µF | ±10% | GRM155R60J225KE95# | | |
| | | | | ±20% | GRM155R60J225ME95# | | |
| | | | B | 0.15µF | ±10% | GRM155B10J154KE01# | |
| | | | | | ±20% | GRM155B10J154ME01# | |
| | | 0.22µF | | ±10% | GRM155B10J224KE01# | | |
| | | | | ±20% | GRM155B10J224ME01# | | |
| | | 0.33µF | | ±10% | GRM155B10J334KE01# | | |
| | | | ±20% | GRM155B10J334ME01# | | | |
| | | 4Vdc | X7R | 1.0µF | ±10% | GRM155R70G105KA12# | |
| | ±20% | | | | GRM155R70G105MA12# | | |
| | X6S | | | 0.15µF | ±10% | GRM155C80G154KE01# | |
| | | | | | ±20% | GRM155C80G154ME01# | |
| | 0.22µF | | | ±10% | GRM155C80G224KE01# | | |
| | | | ±20% | GRM155C80G224ME01# | | | |
| | X6T | | 2.2µF | ±10% | GRM155D80G225KE95# | | |
| | | | | ±20% | GRM155D80G225ME95# | | |
| | | | 0.33µF | ±10% | GRM155C80G334KE01# | | |
| | | | | ±20% | GRM155C80G334ME01# | | |
| | | 0.47µF | ±10% | GRM155C80G474KE01# | | | |
| | ±20% | | GRM155C80G474ME01# | | | | |
| | 0.6mm | 6.3Vdc | X5R | 4.7µF | ±20% | GRM155R60J475ME47# | Degrating |
| | | | B | 4.7µF | ±20% | GRM155B30J475ME47# | Degrating |
| | | 4Vdc | X5R | 4.7µF | ±20% | GRM155R60G475ME47# | |
| | | | B | 4.7µF | ±20% | GRM155B30G475ME47# | |
| | | 2.5Vdc | X6T | 4.7µF | ±20% | GRM155D80E475ME47# | Degrating |
| | 0.7mm | 4Vdc | X5R | 10µF | ±20% | GRM155R60G106ME44# | |
| | | 2.5Vdc | X5R | 10µF | ±20% | GRM155R60E106ME16# | |

■ 1.6x0.8mm

| T max. | Rated Voltage | TC Code | Cap. | Tol. | Part Number | | | |
|--------|---------------|---------|--------|-------|---------------------------|---------------------------|---------------------------|--|
| 0.5mm | 25Vdc | X5R | 1.0µF | ±10% | GRM185R61E105KA12# | Degrating | | |
| | | | | ±20% | GRM185R61E105MA12# | Degrating | | |
| | | | B | 1.0µF | ±10% | GRM185B31E105KA12# | Degrating | |
| | | ±20% | | | GRM185B31E105MA12# | Degrating | | |
| | | 16Vdc | X5R | 1.0µF | ±10% | GRM185R61C105KE44# | | |
| | | | | | ±20% | GRM185R61C105ME44# | | |
| | B | | | 1.0µF | ±10% | GRM185B31C105KE43# | | |
| | | | ±20% | | GRM185B31C105ME43# | | | |
| | 0.9mm | | 100Vdc | X7R | 220pF | ±10% | GRM188R72A221KA01# | |
| | | | | | 330pF | ±10% | GRM188R72A331KA01# | |
| | | 470pF | | | ±10% | GRM188R72A471KA01# | | |

Part number # indicates the package specification code.

GRM Series High Dielectric Constant Type Part Number List

(→ ■ 1.6x0.8mm)

| T max. | Rated Voltage | TC Code | Cap. | Tol. | Part Number |
|---------|---------------|--------------------|--------------------|--------------------|--------------------|
| 0.9mm | 100Vdc | X7R | 680pF | ±10% | GRM188R72A681KA01# |
| | | | 1000pF | ±10% | GRM188R72A102KA01# |
| | | | 1500pF | ±10% | GRM188R72A152KA01# |
| | | | 2200pF | ±10% | GRM188R72A222KA01# |
| | | | 3300pF | ±10% | GRM188R72A332KA01# |
| | | | 4700pF | ±10% | GRM188R72A472KA01# |
| | | | 6800pF | ±10% | GRM188R72A682KA01# |
| | | | 10000pF | ±10% | GRM188R72A103KA01# |
| | | | 15000pF | ±10% | GRM188R72A153KAC4# |
| | | | | ±20% | GRM188R72A153MAC4# |
| | | | 22000pF | ±10% | GRM188R72A223KAC4# |
| | | | | ±20% | GRM188R72A223MAC4# |
| | 0.1μF | ±10% | GRM188R72A104KA35# | | |
| | 50Vdc | X7R | 220pF | ±10% | GRM188R71H221KA01# |
| | | | 330pF | ±10% | GRM188R71H331KA01# |
| | | | 470pF | ±10% | GRM188R71H471KA01# |
| | | | 680pF | ±10% | GRM188R71H681KA01# |
| | | | 1000pF | ±10% | GRM188R71H102KA01# |
| | | | 1500pF | ±10% | GRM188R71H152KA01# |
| | | | 2200pF | ±10% | GRM188R71H222KA01# |
| | | | 3300pF | ±10% | GRM188R71H332KA01# |
| | | | 4700pF | ±10% | GRM188R71H472KA01# |
| | | | 6800pF | ±10% | GRM188R71H682KA01# |
| | | | 10000pF | ±10% | GRM188R71H103KA01# |
| | | | 15000pF | ±10% | GRM188R71H153KA01# |
| | | 22000pF | ±10% | GRM188R71H223KA01# | |
| | | 33000pF | ±10% | GRM188R71H333KA61# | |
| | | 47000pF | ±10% | GRM188R71H473KA61# | |
| | | 68000pF | ±10% | GRM188R71H683KA93# | |
| | | 0.1μF | ±10% | GRM188R71H104KA93# | |
| | | R | 220pF | ±10% | GRM188R11H221KA01# |
| | | | 330pF | ±10% | GRM188R11H331KA01# |
| | | | 470pF | ±10% | GRM188R11H471KA01# |
| 680pF | | | ±10% | GRM188R11H681KA01# | |
| 1000pF | | | ±10% | GRM188R11H102KA01# | |
| 1500pF | | | ±10% | GRM188R11H152KA01# | |
| 2200pF | | | ±10% | GRM188R11H222KA01# | |
| 3300pF | | | ±10% | GRM188R11H332KA01# | |
| 4700pF | | | ±10% | GRM188R11H472KA01# | |
| 6800pF | | | ±10% | GRM188R11H682KA01# | |
| 10000pF | ±10% | | GRM188R11H103KA01# | | |
| 15000pF | ±10% | | GRM188R11H153KA01# | | |
| 22000pF | ±10% | | GRM188R11H223KA01# | | |
| 33000pF | ±10% | | GRM188R11H333KA61# | | |
| 47000pF | ±10% | | GRM188R11H473KA61# | | |
| 68000pF | ±10% | GRM188R11H683KA93# | | | |
| 0.1μF | ±10% | GRM188R11H104KA93# | | | |
| X5R | 1000pF | ±10% | GRM188R61H102KA01# | | |
| | 2200pF | ±10% | GRM188R61H222KA01# | | |
| | 4700pF | ±10% | GRM188R61H472KA01# | | |
| | 10000pF | ±10% | GRM188R61H103KA01# | | |
| | 22000pF | ±10% | GRM188R61H223KA01# | | |
| | 0.22μF | ±10% | GRM188R61H224KAC4# | | |
| | 0.47μF | ±10% | GRM188R61H474KA12# | | |

| T max. | Rated Voltage | TC Code | Cap. | Tol. | Part Number | |
|---------|---------------|--------------------|--------------------|--------------------|--------------------|--------------------|
| 0.9mm | 50Vdc | X5R | 0.47μF | ±20% | GRM188R61H474MA12# | |
| | | | 1.0μF | ±10% | GRM188R61H105KAAL# | |
| | | | | ±20% | GRM188R61H105MAAL# | |
| | | | B | 220pF | ±10% | GRM188B11H221KA01# |
| | | | | | ±20% | GRM188B11H221MA01# |
| | | | | 330pF | ±10% | GRM188B11H331KA01# |
| | | ±20% | | | GRM188B11H331MA01# | |
| | | 470pF | | ±10% | GRM188B11H471KA01# | |
| | | | | ±20% | GRM188B11H471MA01# | |
| | | 680pF | ±10% | GRM188B11H681KA01# | | |
| | | | ±20% | GRM188B11H681MA01# | | |
| | | 1000pF | ±10% | GRM188B11H102KA01# | | |
| | ±20% | | GRM188B11H102MA01# | | | |
| | 1500pF | ±10% | GRM188B11H152KA01# | | | |
| | | ±20% | GRM188B11H152MA01# | | | |
| | 2200pF | ±10% | GRM188B11H222KA01# | | | |
| | | ±20% | GRM188B11H222MA01# | | | |
| | 3300pF | ±10% | GRM188B11H332KA01# | | | |
| | | ±20% | GRM188B11H332MA01# | | | |
| | 4700pF | ±10% | GRM188B11H472KA01# | | | |
| | | ±20% | GRM188B11H472MA01# | | | |
| | 6800pF | ±10% | GRM188B11H682KA01# | | | |
| | | ±20% | GRM188B11H682MA01# | | | |
| | 10000pF | ±10% | GRM188B11H103KA01# | | | |
| | | ±20% | GRM188B11H103MA01# | | | |
| | 15000pF | ±10% | GRM188B11H153KA01# | | | |
| | | ±20% | GRM188B11H153MA01# | | | |
| | 22000pF | ±10% | GRM188B11H223KA01# | | | |
| | | ±20% | GRM188B11H223MA01# | | | |
| | 33000pF | ±10% | GRM188B11H333KA61# | | | |
| | | ±20% | GRM188B11H333MA61# | | | |
| | 47000pF | ±10% | GRM188B11H473KA61# | | | |
| | | ±20% | GRM188B11H473MA61# | | | |
| 68000pF | ±10% | GRM188B31H683KA92# | | | | |
| | ±20% | GRM188B31H683MA92# | | | | |
| 0.1μF | ±10% | GRM188B31H104KA92# | | | | |
| | ±20% | GRM188B31H104MA92# | | | | |
| 0.15μF | ±10% | GRM188B31H154KAC4# | | | | |
| | ±20% | GRM188B31H154MAC4# | | | | |
| 0.22μF | ±10% | GRM188B31H224KAC4# | | | | |
| | ±20% | GRM188B31H224MAC4# | | | | |
| 1.0μF | ±10% | GRM188B31H105KAAL# | | | | |
| | ±20% | GRM188B31H105MAAL# | | | | |
| 25Vdc | X7R | 15000pF | ±10% | GRM188R71E153KA01# | | |
| | | 22000pF | ±10% | GRM188R71E223KA01# | | |
| | | | ±20% | GRM188R71E223MA01# | | |
| | | 33000pF | ±10% | GRM188R71E333KA01# | | |
| | | 47000pF | ±10% | GRM188R71E473KA01# | | |
| | 68000pF | ±10% | GRM188R71E683KA01# | | | |
| | B | 0.15μF | ±10% | GRM188R71E154KA01# | | |
| | | 0.22μF | ±10% | GRM188R71E224KA88# | | |
| | | 0.47μF | ±10% | GRM188R71E474KA12# | | |
| | | 1.0μF | ±10% | GRM188R71E105KA12# | | |
| ±20% | | | GRM188R71E105MA12# | | | |

Part number # indicates the package specification code.

For General Purpose GRM Series
 Capacitor Array GNM Series
 Low ESL LLI Series
 High-Q Type GJM Series
 High Frequency GQM Series
 Monolithic Microchip GMA Series
 For Bonding GMD Series
 Product Information

GRM Series High Dielectric Constant Type Part Number List

(→ ■ 1.6x0.8mm)

| T max. | Rated Voltage | TC Code | Cap. | Tol. | Part Number | T max. | Rated Voltage | TC Code | Cap. | Tol. | Part Number | | |
|--------|---------------|---------------------------|---------------------------|---------------------------|---------------------------|---------------------------|---------------------------|---------------------------|---------------------------|---------------------------|---------------------------|---------------------------|---------------------------|
| 0.9mm | 25Vdc | R | 15000pF | ±10% | GRM188R11E153KA01# | 0.9mm | 16Vdc | X7R | 1.0µF | ±20% | GRM188R71C105MA12# | | |
| | | | 22000pF | ±10% | GRM188R11E223KA01# | | | | ±20% | GRM188R71C105ME15# | | | |
| | | | | ±20% | GRM188R11E223MA01# | | | | X7S | 0.68µF | ±10% | GRM188C71C684KA12# | |
| | | | 33000pF | ±10% | GRM188R11E333KA01# | | | | | R | 0.15µF | ±10% | GRM188R11C154KA01# |
| | | | 47000pF | ±10% | GRM188R11E473KA01# | | | | | | 0.22µF | ±10% | GRM188R11C224KA01# |
| | | | 68000pF | ±10% | GRM188R11E683KA01# | | | 0.33µF | ±10% | | GRM188R11C334KA01# | | |
| | | | 0.15µF | ±10% | GRM188R11E154KA01# | | | 0.47µF | ±10% | | GRM188R11C474KA88# | | |
| | | | 0.22µF | ±10% | GRM188R11E224KA88# | | | X6S | 1.0µF | ±10% | GRM188C81C105KA12# | | |
| | | | | ±10% | GRM188R11E224KA88# | | | | ±20% | GRM188C81C105MA12# | | | |
| | | | | ±20% | GRM188C81E105KAAD# | | | | 2.2µF | ±10% | GRM188C81C225KA12# | | |
| | | | ±20% | GRM188C81E105MAAD# | ±20% | | | | | GRM188C81C225MA12# | | | |
| | | X6S | 1.0µF | ±10% | GRM188R61E104KA01# | | | X5R | | 0.22µF | ±10% | GRM188R61C224KA88# | |
| | | | | ±20% | GRM188R61E104KA01# | | | | 0.68µF | ±10% | GRM188R61C684KA75# | | |
| | | | 0.22µF | ±10% | GRM188R61E224KA88# | | | | ±20% | GRM188R61C684MA75# | | | |
| | | | | ±20% | GRM188R61E224KA88# | | | | 1.0µF | ±10% | GRM188R61C105KA93# | | |
| | | | 0.47µF | ±10% | GRM188R61E474KA12# | | | | ±20% | GRM188R61C105KA93# | | | |
| | | | | ±20% | GRM188R61E474MA12# | | | | 2.2µF | ±10% | GRM188R61C225KE15# | | |
| | | | 0.68µF | ±10% | GRM188R61E684KA75# | | | | 1.0µF | ±10% | GRM188R61C225KE15# | | |
| | | | | ±20% | GRM188R61E684MA75# | | | | | B | 0.15µF | ±10% | GRM188B11C154KA01# |
| | | | 1.0µF | ±10% | GRM188R61E105KA12# | | | | | | 0.22µF | ±10% | GRM188B11C224KA01# |
| | | | | ±20% | GRM188R61E105MA12# | | | | | | 0.33µF | ±10% | GRM188B11C334KA01# |
| | | 2.2µF | ±10% | GRM188R61E225KA12# | ±20% | | | GRM188B11C334MA01# | | | | | |
| | | | ±20% | GRM188R61E225MA12# | 0.68µF | | | ±10% | GRM188B31C684KA75# | | | | |
| | | B | 2200pF | ±10% | | | | GRM188B11E222KA01# | ±20% | GRM188B31C684MA75# | | | |
| | | | 3300pF | ±10% | | | | GRM188B11E332KA01# | 1.0µF | ±10% | GRM188B31C105KA92# | | |
| | | | 4700pF | ±10% | GRM188B11E472KA01# | | | ±20% | | GRM188B31C105MA92# | | | |
| | | | 6800pF | ±10% | GRM188B11E682KA01# | | | 2.2µF | | ±10% | GRM188B31C225KE14# | | |
| | | | 10000pF | ±10% | GRM188B11E103KA01# | | | 2.2µF | ±10% | GRM188B31C225KE14# | | | |
| | | | ±20% | GRM188B11E103MA01# | X7R | | | | 0.33µF | ±10% | GRM188R71A334KA61# | | |
| | | | 15000pF | ±10% | | | | | GRM188B11E153KA01# | ±20% | GRM188R71A334MA61# | | |
| | ±20% | | GRM188B11E153MA01# | 0.47µF | | ±10% | GRM188R71A474KA61# | | | | | | |
| | 22000pF | | ±10% | GRM188B11E223KA01# | | 0.68µF | ±10% | GRM188R71A684KA61# | | | | | |
| | ±20% | | GRM188B11E223MA01# | 2.2µF | ±10% | GRM188R71A684MA61# | | | | | | | |
| | 33000pF | ±10% | GRM188B11E333KA01# | | ±20% | GRM188R71A684MA61# | | | | | | | |
| | ±20% | GRM188B11E333MA01# | X7T | | 2.2µF | ±10% | GRM188D71A225KE15# | | | | | | |
| | 47000pF | ±10% | | GRM188B11E473KA01# | ±20% | GRM188D71A225ME34# | | | | | | | |
| | ±20% | GRM188B11E473MA01# | | X6S | 2.2µF | ±10% | GRM188C81A225KE34# | | | | | | |
| | 68000pF | ±10% | GRM188B11E683KA01# | | ±20% | GRM188C81A225ME34# | | | | | | | |
| | ±20% | GRM188B11E683MA01# | X5R | | 0.33µF | ±10% | GRM188R61A334KA61# | | | | | | |
| | 0.1µF | ±10% | | GRM188B11E104KA01# | ±20% | GRM188R61A334MA61# | | | | | | | |
| | ±20% | GRM188B11E104MA01# | | 0.68µF | ±10% | GRM188R61A684KA61# | | | | | | | |
| | 0.15µF | ±10% | | GRM188B11E154KA01# | ±20% | GRM188R61A684MA61# | | | | | | | |
| | 0.22µF | ±10% | GRM188B31E224KA87# | 2.2µF | ±10% | GRM188R61A225KE34# | | | | | | | |
| | 0.47µF | ±10% | GRM188B31E474KA75# | | ±20% | GRM188R61A225ME34# | | | | | | | |
| | ±20% | GRM188B31E474MA75# | B | | 0.33µF | ±10% | GRM188B11A334KA61# | | | | | | |
| | 0.68µF | ±10% | | GRM188B31E684KA75# | ±20% | GRM188B11A334MA61# | | | | | | | |
| | ±20% | GRM188B31E684MA75# | | 0.68µF | ±10% | GRM188B11A684KA61# | | | | | | | |
| | 1.0µF | ±10% | | GRM188B31E105KA75# | ±20% | GRM188B11A684MA61# | | | | | | | |
| | | ±20% | GRM188B31E105MA75# | 2.2µF | ±10% | GRM188B31A225KE33# | | | | | | | |
| | 2.2µF | ±10% | GRM188B31E225KA12# | | ±20% | GRM188B31A225ME33# | | | | | | | |
| | | ±20% | GRM188B31E225MA12# | | X7R | 1.0µF | ±10% | GRM188R70J105KA01# | | | | | |
| | 16Vdc | X7R | 0.15µF | ±10% | | GRM188R71C154KA01# | ±20% | GRM188R70J105MA01# | | | | | |
| | | | 0.22µF | ±10% | | GRM188R71C224KA01# | X7S | 2.2µF | ±10% | GRM188C70J225KE20# | | | |
| | | | 0.33µF | ±10% | | GRM188R71C334KA01# | | ±20% | GRM188C70J225ME20# | | | | |
| | | | 0.47µF | ±10% | | GRM188R71C474KA88# | | X6S | 2.2µF | ±10% | GRM188C80J225KE19# | | |
| | | | 1.0µF | ±10% | GRM188R71C105KA12# | ±20% | GRM188C80J225ME19# | | | | | | |
| | ±10% | GRM188R71C105KE15# | | | | | | | | | | | |

Part number # indicates the package specification code.

GRM Series High Dielectric Constant Type Part Number List

(→ ■ 1.6x0.8mm)

| T max. | Rated Voltage | TC Code | Cap. | Tol. | Part Number | | |
|--------|---------------|---------|-------|--------------------|--------------------|--------------------|--------------------|
| 0.9mm | 6.3Vdc | X6S | 4.7μF | ±10% | GRM188C80J475KE15# | Derating | |
| | | | | ±20% | GRM188C80J475ME15# | Derating | |
| | | X5R | 10μF | ±20% | GRM188R60J106ME47# | | |
| | | | | B | 10μF | ±20% | GRM188B30J106ME47# |
| | | 4Vdc | X6S | | | 4.7μF | ±10% |
| | | | | ±20% | GRM188C80G475ME19# | | |
| | X5R | | 10μF | ±20% | GRM188R60G106ME47# | | |
| | | | | B | 10μF | ±20% | GRM188B30G106ME46# |
| | X6S | | 10μF | | | ±20% | GRM188C80E106ME47# |
| | | | | | | | |
| | 0.95mm | 25Vdc | X5R | 4.7μF | ±10% | GRM188R61E475KE11# | |
| | | | | | X5R | 4.7μF | ±10% |
| B | | 4.7μF | ±10% | GRM188B31C475KAAJ# | | | Derating |
| | | | | | | | |
| 16Vdc | | X5R | 4.7μF | ±10% | GRM188R61C475MAAJ# | Derating | |
| | | | | | | | |
| 10Vdc | B | 10μF | ±20% | GRM188B31A106ME69# | Derating | | |
| | | | | | | | |
| 1mm | 35Vdc | X5R | 4.7μF | ±10% | GRM188R6YA475KE15# | | |
| | | | | ±20% | GRM188R6YA475ME15# | | |
| | | | | | | | |
| | 25Vdc | X5R | 4.7μF | ±10% | GRM188R61E475KE15# | | |
| | | | | ±20% | GRM188R61E475ME15# | | |
| | | | | | | | |
| 16Vdc | X6S | 10μF | ±20% | GRM188C81C106MA73# | | | |
| | | | | | | | |
| 10Vdc | X7T | 10μF | ±20% | GRM188D71A106MA73# | | | |
| | | | | | | | |
| 6.3Vdc | X7T | 10μF | ±20% | GRM188D70J106MA73# | | | |
| | | | X5R | 22μF | ±20% | GRM188R60J226MEA0# | Derating |
| | | | | | | | |
| 4Vdc | X6S | 22μF | ±20% | GRM188C80G226MEA0# | Derating | | |
| | | | X5R | 22μF | ±20% | GRM188R60G226MEA0# | |
| | | | | | | | |
| | | | | | | | |

■ 2.0x1.25mm

| T max. | Rated Voltage | TC Code | Cap. | Tol. | Part Number | | |
|--------|---------------|---------|---------|--------------------|--------------------|--|--|
| 0.7mm | 25Vdc | X5R | 1.0μF | ±10% | GRM216R61E105KA12# | | |
| | | | | | | | |
| | 16Vdc | X6S | 1.0μF | ±10% | GRM216C81C105KA12# | | |
| 0.95mm | 100Vdc | X7R | 6800pF | ±10% | GRM219R72A682KA01# | | |
| | | | | ±10% | GRM219R72A103KA01# | | |
| | | | | ±20% | GRM219R72A103MA01# | | |
| | | | 10000pF | ±10% | GRM219R71H103KA01# | | |
| | | | | ±20% | GRM219R71H103MA01# | | |
| | | | | | | | |
| | 50Vdc | X7R | 15000pF | ±10% | GRM219R71H153KA01# | | |
| | | | | ±20% | GRM219R71H153MA01# | | |
| | | | | | | | |
| | | | 33000pF | ±10% | GRM219R71H333KA01# | | |
| | | | | ±10% | GRM219R71H334KA88# | | |
| | | | | | | | |
| | | R | 33000pF | ±10% | GRM219R11H333KA01# | | |
| | | X5R | 1.0μF | ±10% | GRM219R61H105KA73# | | |
| | | | | ±20% | GRM219R61H105MA73# | | |
| | | | 2.2μF | ±10% | GRM219R61H225KE15# | | |
| ±20% | | | | GRM219R61H225ME15# | | | |
| B | | | 33000pF | ±10% | GRM219B11H333KA01# | | |
| | | | | | | | |
| | | | | | | | |

| T max. | Rated Voltage | TC Code | Cap. | Tol. | Part Number | | |
|--------|--------------------|-----------------|--------------------|--------------------|--------------------|--------------------|-----------------|
| 0.95mm | 50Vdc | B | 0.33μF | ±20% | GRM219B31H334MA87# | | |
| | | | | ±10% | GRM219B31H105KA73# | | |
| | | | 1.0μF | ±10% | GRM219B31H105MA73# | | |
| | | | | ±20% | GRM219B31H105MA73# | | |
| | | | 2.2μF | ±10% | GRM219B31H225KE15# | | |
| | | | | ±20% | GRM219B31H225ME15# | | |
| | 35Vdc | X6S | 2.2μF | ±10% | GRM219C8YA225KE15# | | |
| | | | | ±20% | GRM219C8YA225ME15# | | |
| | | | X5R | 4.7μF | ±10% | GRM219R6YA475KA73# | Derating |
| | | | | | ±20% | GRM219R6YA475MA73# | Derating |
| | | 25Vdc | X7R | 68000pF | ±10% | GRM219R71E683KA01# | |
| | | | | | ±10% | GRM219R71E104KA01# | |
| | ±20% | | | | GRM219R71E104MA01# | | |
| | | | | | | | |
| | 0.68μF | | | ±10% | GRM219R71E684KA88# | | |
| | | | | ±10% | GRM219R71E105KA88# | | |
| | R | 68000pF | ±10% | GRM219R11E683KA01# | | | |
| | X6S | 2.2μF | ±10% | GRM219C81E225KE15# | | | |
| ±20% | | | GRM219C81E225ME15# | | | | |
| X5R | 2.2μF | ±10% | GRM219R61E225KA12# | | | | |
| | | ±20% | GRM219R61E225MA12# | | | | |
| | 4.7μF | ±10% | GRM219R61E475KA73# | | | | |
| | | ±20% | GRM219R61E475MA73# | | | | |
| | 10μF | ±10% | GRM219R61E106KA12# | Derating | | | |
| | | ±20% | GRM219R61E106MA12# | Derating | | | |
| B | 0.47μF | ±10% | GRM219B31E474KA88# | | | | |
| | | ±10% | GRM219B31E684KA88# | | | | |
| | | ±10% | GRM219B31E105KA88# | | | | |
| | | ±10% | GRM219B31E225KA75# | | | | |
| | | ±20% | GRM219B31E225MA75# | | | | |
| | | ±10% | GRM219B31E106KA12# | Derating | | | |
| ±20% | GRM219B31E106MA12# | Derating | | | | | |
| 16Vdc | X7R | 0.33μF | ±10% | GRM219R71C334KA88# | | | |
| | | | ±10% | GRM219R71C684KA01# | | | |
| | | | ±10% | GRM219R71C225KE15# | | | |
| | | 2.2μF | ±20% | GRM219R71C225ME15# | | | |
| | | | | | | | |
| | | | | | | | |
| R | 0.68μF | ±10% | GRM219R11C684KA01# | | | | |
| X6S | 4.7μF | ±10% | GRM219C81C475KA73# | | | | |
| | | ±20% | GRM219C81C475MA73# | | | | |
| X5R | 4.7μF | ±10% | GRM219R61C475KE15# | | | | |
| | | ±10% | GRM219R61C106KA73# | | | | |
| | 10μF | ±10% | GRM219R61C106MA73# | | | | |
| | | ±20% | GRM219R61C106MA73# | | | | |
| | B | 0.68μF | ±10% | GRM219B11C684KA01# | | | |
| | | | ±10% | GRM219B31C475KE15# | | | |
| ±10% | GRM219B31C106KA73# | | | | | | |
| ±20% | GRM219B31C106MA73# | | | | | | |
| 10Vdc | X7R | 2.2μF | ±10% | GRM219R71A225KE15# | | | |
| | | | ±20% | GRM219R71A225ME15# | | | |
| | X7T | 4.7μF | ±10% | GRM219D71A475KE15# | Derating | | |
| | | | ±20% | GRM219D71A475ME15# | Derating | | |
| | X5R | 22μF | ±20% | GRM219R61A226MEA0# | Derating | | |
| | | | B | 22μF | ±20% | GRM219B31A226MEA0# | Derating |
| 6.3Vdc | X6S | 10μF | | | ±10% | GRM219C80J106KE39# | |
| | | | ±20% | GRM219C80J106ME39# | | | |
| | | | | | | | |
| | X5R | 22μF | ±20% | GRM219R60J226ME47# | Derating | | |
| | | | B | 22μF | ±20% | GRM219B30J226ME47# | Derating |
| | | | | | | | |

Part number # indicates the package specification code.

For General Purpose GRM Series
 Capacitor Array GNM Series
 Low ESL LLD Series
 High-Q Type GJM Series
 High Frequency GQM Series
 Monolithic Microchip GMA Series
 For Bonding GMD Series
 Product Information

GRM Series High Dielectric Constant Type Part Number List

(→ ■ 2.0x1.25mm)

| T max. | Rated Voltage | TC Code | Cap. | Tol. | Part Number | | | |
|--------|---------------|---------|--------------------|--------------------|--------------------|--------------------|--------------------|--|
| 0.95mm | 4Vdc | X6S | 10μF | ±10% | GRM219C80G106KE19# | | | |
| | | | | ±20% | GRM219C80G106ME19# | | | |
| | | X5R | 47μF | ±20% | GRM219R60G476ME44# | Derating | | |
| 1mm | 100Vdc | X7R | 0.22μF | ±10% | GRM21AR72A224KAC5# | | | |
| | | | 0.33μF | ±10% | GRM21AR72A334KAC5# | | | |
| | 50Vdc | X7R | 22000pF | ±10% | GRM219R71H223KA17# | | | |
| | | | | ±20% | GRM219R71H223MA17# | | | |
| 1.35mm | 100Vdc | X7R | 10000pF | ±10% | GRM21BR72A103KA01# | | | |
| | | | 15000pF | ±10% | GRM21BR72A153KA01# | | | |
| | | | 22000pF | ±10% | GRM21BR72A223KA01# | | | |
| | | | 33000pF | ±10% | GRM21BR72A333KA01# | | | |
| | | | 47000pF | ±10% | GRM21BR72A473KA01# | | | |
| | | | | ±20% | GRM21BR72A683KAC4# | | | |
| | | | | | ±20% | GRM21BR72A683MAC4# | | |
| | | | | | ±20% | GRM21BR72A104KAC4# | | |
| | | | 0.1μF | ±10% | GRM21BR72A104MAC4# | | | |
| | | | | ±20% | GRM21BR72A104MAC4# | | | |
| | | | 50Vdc | X7R | 47000pF | ±10% | GRM21BR71H473KA01# | |
| | | | | | 68000pF | ±10% | GRM21BR71H683KA01# | |
| | 0.1μF | ±10% | | | GRM21BR71H104KA01# | | | |
| | | ±20% | | | GRM21BR71H104MA01# | | | |
| | 0.15μF | ±10% | | | GRM21BR71H154KA01# | | | |
| | 0.22μF | ±10% | | | GRM21BR71H224KA01# | | | |
| | 0.47μF | ±10% | | GRM21BR71H474KA88# | | | | |
| | 1.0μF | ±10% | | GRM21BR71H105KA12# | | | | |
| | R | 47000pF | | ±10% | GRM21BR11H473KA01# | | | |
| | | 68000pF | | ±10% | GRM21BR11H683KA01# | | | |
| | | 0.1μF | | ±10% | GRM21BR11H104KA01# | | | |
| | ±20% | | | GRM21BR11H104MA01# | | | | |
| | X5R | 1.0μF | ±10% | GRM21BR61H105KA12# | | | | |
| | | | | | | | | |
| | B | 47000pF | ±10% | GRM21BB11H473KA01# | | | | |
| | | 68000pF | ±10% | GRM21BB11H683KA01# | | | | |
| | | 0.1μF | ±10% | GRM21BB11H104KA01# | | | | |
| | | | ±20% | GRM21BB11H104MA01# | | | | |
| | | 0.15μF | ±10% | GRM21BB31H154KA88# | | | | |
| | | | ±20% | GRM21BB31H154MA88# | | | | |
| 0.22μF | | ±10% | GRM21BB31H224KA88# | | | | | |
| | | ±20% | GRM21BB31H224MA88# | | | | | |
| 0.47μF | | ±10% | GRM21BB31H474KA87# | | | | | |
| | | ±20% | GRM21BB31H474MA87# | | | | | |
| 0.68μF | | ±10% | GRM21BB31H684KAC4# | | | | | |
| | | ±20% | GRM21BB31H684MAC4# | | | | | |
| 1.0μF | | ±10% | GRM21BB31H105KA12# | | | | | |
| | | ±20% | GRM21BB31H105MA12# | | | | | |
| 25Vdc | | X7R | 0.1μF | ±10% | GRM21BR71E104KA01# | | | |
| | | | 0.15μF | ±10% | GRM21BR71E154KA01# | | | |
| | | R | 0.1μF | ±10% | GRM21BR11E104KA01# | | | |
| | | | 0.15μF | ±10% | GRM21BR11E154KA01# | | | |
| | ±20% | | GRM21BR11E154MA01# | | | | | |
| | 0.68μF | ±10% | GRM21BR11E684KA88# | | | | | |
| | | | | | | | | |
| | X6S | 4.7μF | ±10% | GRM21BC81E475KA12# | | | | |
| | | ±20% | GRM21BC81E475MA12# | | | | | |
| | X5R | 2.2μF | ±10% | GRM21BR61E225KA12# | | | | |
| | | | ±20% | GRM21BR61E225MA12# | | | | |
| | | 4.7μF | ±10% | GRM21BR61E475KA12# | | | | |

| T max. | Rated Voltage | TC Code | Cap. | Tol. | Part Number | | |
|--------|---------------|--------------------|--------------------|--------------------|--------------------|--------------------|--|
| 1.35mm | 25Vdc | X5R | 4.7μF | ±20% | GRM21BR61E475MA12# | | |
| | | | B | 0.15μF | ±10% | GRM21BB11E154KA01# | |
| | | | | 0.22μF | ±10% | GRM21BB11E224KA01# | |
| | | | | 0.33μF | ±10% | GRM21BB11E334KA01# | |
| | | | 2.2μF | ±10% | GRM21BB31E225KA75# | | |
| | | | | ±20% | GRM21BB31E225MA75# | | |
| | | ±10% | | GRM21BB31E475KA75# | | | |
| | | 16Vdc | X7R | 2.2μF | ±10% | GRM21BR71C225KA12# | |
| | | | | ±20% | GRM21BR71C225MA12# | | |
| | | | X6S | 4.7μF | ±10% | GRM21BC81C475KA88# | |
| | | | | | | | |
| | | | X5R | 2.2μF | ±10% | GRM21BR61C225KA88# | |
| | 4.7μF | | | ±10% | GRM21BR61C475KA88# | | |
| | 10μF | ±10% | GRM21BR61C106KE15# | | | | |
| | | ±20% | GRM21BR61C106ME15# | | | | |
| | B | 2.2μF | ±10% | GRM21BB31C225KA87# | | | |
| | | 4.7μF | ±10% | GRM21BB31C475KA87# | | | |
| | | 10μF | ±10% | GRM21BB31C106KE15# | | | |
| | 10Vdc | X6S | 10μF | ±10% | GRM21BC81A106KE18# | | |
| | | | | ±20% | GRM21BC81A106ME18# | | |
| | | | | | | | |
| | 6.3Vdc | X6S | 10μF | ±10% | GRM21BC80J106KE19# | | |
| | | | | ±20% | GRM21BC80J106ME19# | | |
| | 1.4mm | 100Vdc | X7R | 0.47μF | ±10% | GRM21BR72A474KA73# | |
| X5R | | | | 2.2μF | ±10% | GRM21BR61H225KA73# | |
| | | | | ±20% | GRM21BR61H225MA73# | | |
| 4.7μF | | | ±10% | GRM21BR61H475KE51# | | | |
| | | | ±20% | GRM21BR61H475ME51# | | | |
| | | | | | | | |
| B | | 2.2μF | ±10% | GRM21BB31H225KA73# | | | |
| | | ±20% | GRM21BB31H225MA73# | | | | |
| | | 4.7μF | ±10% | GRM21BB31H475KE51# | | | |
| | | | ±20% | GRM21BB31H475ME51# | | | |
| | | | | | | | |
| | | 25Vdc | X7R | 1.0μF | ±10% | GRM21BR71E105KA99# | |
| 2.2μF | | | | ±10% | GRM21BR71E225KA73# | | |
| R | | | 1.0μF | ±10% | GRM21BR11E105KA99# | | |
| | | | | | | | |
| X5R | | | 10μF | ±10% | GRM21BR61E106KA73# | | |
| | | | ±20% | GRM21BR61E106MA73# | | | |
| B | | 1.0μF | ±10% | GRM21BB31E105KA98# | | | |
| | | 10μF | ±10% | GRM21BB31E106KA73# | | | |
| ±20% | | GRM21BB31E106MA73# | | | | | |
| 16Vdc | | X7R | 4.7μF | ±10% | GRM21BR71C475KA73# | | |
| | | | ±20% | GRM21BR71C475MA73# | | | |
| | | X6S | 10μF | ±10% | GRM21BC81C106KA73# | | |
| | | | ±20% | GRM21BC81C106MA73# | | | |
| | 10Vdc | X7R | 4.7μF | ±10% | GRM21BR71A475KA73# | | |
| | | | ±20% | GRM21BR71A475MA73# | | | |
| 10μF | ±10% | GRM21BR71A106KE51# | | | | | |
| | ±20% | GRM21BR71A106ME51# | | | | | |
| 6.3Vdc | X7R | 10μF | ±10% | GRM21BR70J106KE76# | | | |
| | | | ±20% | GRM21BR70J106ME76# | | | |
| | X6S | 22μF | ±20% | GRM21BC80J226ME51# | Derating | | |
| | | | | | | | |
| | X5R | 22μF | ±20% | GRM21BR60J226ME39# | Derating | | |
| | | | | | | | |
| B | 22μF | ±20% | GRM21BB30J226ME38# | | | | |
| | | | | | | | |

For General Purpose
GRM Series

Capacitor Array
GJM Series

Low ESL
LLC Series

High-Q Type
GJM Series

High Frequency
GQM Series

Monolithic Microchip
GMA Series

For Bonding
GMD Series

Product Information

Part number # indicates the package specification code.

GRM Series High Dielectric Constant Type Part Number List

(→ ■ 2.0×1.25mm)

| T max. | Rated Voltage | TC Code | Cap. | Tol. | Part Number | |
|--------|---------------|---------|------|------|--------------------|-----------|
| 1.4mm | 4Vdc | X7U | 22µF | ±20% | GRM21BE70G226ME51# | |
| | | X6S | 22µF | ±20% | GRM21BC80G226ME39# | |
| 1.45mm | 25Vdc | X5R | 22µF | ±20% | GRM21BR61E226ME44# | |
| | 6.3Vdc | X5R | 47µF | ±20% | GRM21BR60J476ME15# | Degrating |
| | | B | 47µF | ±20% | GRM21BB30J476ME15# | Degrating |
| | 4Vdc | X6S | 47µF | ±20% | GRM21BC80G476ME15# | Degrating |
| | | X5R | 47µF | ±20% | GRM21BR60G476ME15# | |
| | | B | 47µF | ±20% | GRM21BB30G476ME15# | |

■ 3.2×1.6mm

| T max. | Rated Voltage | TC Code | Cap. | Tol. | Part Number | | | |
|--------|---------------|---------|--------------------|--------------------|--------------------|--------------------|--------------------|--|
| 0.7mm | 25Vdc | X5R | 2.2µF | ±10% | GRM316R61E225KA12# | | | |
| | | B | 2.2µF | ±10% | GRM316B31E225KA75# | | | |
| 0.95mm | 16Vdc | X6S | 2.2µF | ±10% | GRM316C81C225KA12# | | | |
| | 100Vdc | X7R | 15000pF | ±10% | GRM319R72A153KA01# | | | |
| | | | 0.1µF | ±10% | GRM319R72A104KA01# | | | |
| | 50Vdc | X7R | 0.33µF | ±10% | GRM319R71H334KA01# | | | |
| | 35Vdc | X5R | 10µF | ±10% | GRM319R6YA106KA12# | Degrating | | |
| | | | ±20% | GRM319R6YA106MA12# | Degrating | | | |
| | 25Vdc | X7R | 0.33µF | ±10% | GRM319R71E334KA01# | | | |
| | | | R | 0.33µF | ±10% | GRM319R11E334KA01# | | |
| | | | B | 0.33µF | ±10% | GRM319B11E334KA01# | | |
| | 16Vdc | X6S | 4.7µF | ±10% | GRM319C81C475KA12# | | | |
| | | | X5R | 10µF | ±10% | GRM319R61C106KE15# | | |
| | | | | ±20% | GRM319R61C106ME15# | | | |
| B | 0.47µF | ±10% | GRM319B11C474KA01# | | | | | |
| | | 10µF | ±10% | GRM319B31C106KE15# | | | | |
| | | ±20% | GRM319B31C106ME15# | | | | | |
| 10Vdc | X5R | 22µF | ±20% | GRM319R61A226ME15# | | | | |
| | | B | 22µF | ±20% | GRM319B31A226ME15# | | | |
| 6.3Vdc | X6S | 22µF | ±20% | GRM319C80J226ME15# | | | | |
| | | X5R | 22µF | ±20% | GRM319R60J226ME15# | | | |
| | | B | 22µF | ±20% | GRM319B30J226ME15# | | | |
| | | | 22µF | ±20% | GRM319B30J226ME15# | | | |
| 1.25mm | 100Vdc | X7R | 22000pF | ±10% | GRM31MR72A223KA01# | | | |
| | | | 33000pF | ±10% | GRM31MR72A333KA01# | | | |
| | | | 47000pF | ±10% | GRM31MR72A473KA01# | | | |
| | | | 68000pF | ±10% | GRM31MR72A683KA01# | | | |
| | | | 0.15µF | ±10% | GRM31MR72A154KA01# | | | |
| | | | 0.22µF | ±10% | GRM31MR72A224KA01# | | | |
| | 50Vdc | X7R | 0.15µF | ±10% | GRM31MR71H154KA01# | | | |
| | | | 0.22µF | ±10% | GRM31MR71H224KA01# | | | |
| | | | 0.47µF | ±10% | GRM31MR71H474KA01# | | | |
| | | | 0.68µF | ±10% | GRM31MR71H684KA88# | | | |
| | | | 1.0µF | ±10% | GRM31MR71H105KA88# | | | |
| | | | R | 0.15µF | ±10% | GRM31MR11H154KA01# | | |
| | B | 0.22µF | ±10% | GRM31MR11H224KA01# | | | | |
| | | | 0.15µF | ±10% | GRM31MB11H154KA01# | | | |
| | | | 0.22µF | ±10% | GRM31MB11H224KA01# | | | |
| | 1.0µF | ±10% | GRM31MB31H105KA87# | | | | | |
| | | | 25Vdc | X5R | 10µF | ±20% | GRM31MR61E106MA12# | |
| | | | B | | 0.22µF | ±10% | GRM31MB11E224KA01# | |

| T max. | Rated Voltage | TC Code | Cap. | Tol. | Part Number | | |
|--------|---------------|--------------------|--------------------|--------------------|--------------------|--------------------|--|
| 1.25mm | 16Vdc | X6S | 10µF | ±10% | GRM31MC81C106KA12# | | |
| | | B | 0.68µF | ±10% | GRM31MB11C684KA01# | | |
| 1.3mm | 100Vdc | X7R | 0.47µF | ±10% | GRM31MR72A474KA35# | | |
| | | | ±20% | GRM31MR72A474MA35# | | | |
| | 0.68µF | ±10% | GRM31MR72A684KA35# | | | | |
| | | | B | 2.2µF | ±10% | GRM31MB31E225KA92# | |
| 25Vdc | B | 2.2µF | ±10% | GRM31MB31E225KA92# | | | |
| 1.8mm | 100Vdc | X7R | 1.0µF | ±10% | GRM31CR72A105KA01# | | |
| | | | 2.2µF | ±10% | GRM31CR71H225KA88# | | |
| | 4.7µF | ±10% | GRM31CR71H475KA12# | | | | |
| | | | X5R | 2.2µF | ±10% | GRM31CR61H225KA88# | |
| | B | 2.2µF | ±10% | GRM31CB31H225KA87# | | | |
| | | | ±20% | GRM31CB31H225MA87# | | | |
| | 4.7µF | ±10% | GRM31CB31H475KA12# | | | | |
| | | | ±20% | GRM31CB31H475MA12# | | | |
| | 25Vdc | X7R | 4.7µF | ±10% | GRM31CR71E475KA88# | | |
| | | | 10µF | ±10% | GRM31CR71E106KA12# | | |
| | ±20% | GRM31CR71E106MA12# | X6S | 10µF | ±10% | GRM31CC81E106KE15# | |
| | | | | ±20% | GRM31CC81E106MA12# | | |
| X5R | 10µF | ±10% | GRM31CR61E106KA12# | | | | |
| | | 22µF | ±20% | GRM31CR61E226ME15# | | | |
| B | 10µF | ±10% | GRM31CB31E106KA75# | | | | |
| | | 22µF | ±20% | GRM31CB31E226ME15# | | | |
| 16Vdc | X7R | 4.7µF | ±20% | GRM31CR71C475MA01# | | | |
| | | 10µF | ±10% | GRM31CR71C106KAC7# | | | |
| | ±20% | GRM31CR71C106MAC7# | | | | | |
| | R | 4.7µF | ±20% | GRM31CR11C475MA01# | | | |
| | X6S | 22µF | ±20% | GRM31CC81C226ME15# | | | |
| | | | X5R | 10µF | ±10% | GRM31CR61C106KA88# | |
| 22µF | ±20% | GRM31CR61C226ME15# | | | | | |
| | | B | 10µF | ±10% | GRM31CB31C106KA88# | | |
| 22µF | ±20% | GRM31CB31C226ME15# | | | | | |
| 10Vdc | X7R | 22µF | ±20% | GRM31CR71A226ME15# | | | |
| | | X6S | 22µF | ±20% | GRM31CC81A226ME19# | | |
| | X5R | 22µF | ±20% | GRM31CR61A226ME19# | | | |
| | | | 47µF | ±20% | GRM31CR61A476ME15# | | |
| B | 22µF | ±20% | GRM31CB31A226ME19# | | | | |
| | | 47µF | ±20% | GRM31CB31A476ME15# | | | |
| 6.3Vdc | X7R | 22µF | ±20% | GRM31CR70J226ME19# | | | |
| | | X7U | 47µF | ±20% | GRM31CE70J476ME15# | Degrating | |
| | X6S | 22µF | ±20% | GRM31CC80J226ME19# | | | |
| | | | 47µF | ±20% | GRM31CC80J476ME18# | | |
| | X5R | 47µF | ±20% | GRM31CR60J476ME19# | | | |
| | | | B | 47µF | ±20% | GRM31CB30J476ME18# | |
| 4Vdc | X7U | 47µF | ±20% | GRM31CE70G476ME15# | | | |
| | | X6S | 47µF | ±20% | GRM31CC80G476ME19# | | |
| 1.9mm | 100Vdc | X7R | 2.2µF | ±10% | GRM31CR72A225KA73# | | |
| | | | ±20% | GRM31CR72A225MA73# | | | |
| | 6.3Vdc | X6T | 100µF | ±20% | GRM31CD80J107ME39# | Degrating | |
| | | | X5R | 100µF | ±20% | GRM31CR60J107ME39# | |
| | 4Vdc | X7U | 100µF | ±20% | GRM31CE70G107ME39# | Degrating | |
| | | | X6T | 100µF | ±20% | GRM31CD80G107ME39# | |
| X5R | 100µF | ±20% | GRM31CR60G107ME39# | | | | |

Part number # indicates the package specification code.

For General Purpose GRM Series
 Capacitor Array GNM Series
 Low ESL LLI Series
 High-Q Type GJM Series
 High Frequency GQM Series
 Monolithic Microchip GMA Series
 For Bonding GMD Series
 Product Information

GRM Series High Dielectric Constant Type Part Number List

■ 3.2x2.5mm

| T max. | Rated Voltage | TC Code | Cap. | Tol. | Part Number | | |
|--------|---------------|---------|--------|--------------------|--------------------|--------------------|--|
| 1mm | 6.3Vdc | X5S | 150μF | ±20% | GRM32RC60J157ME15# | Derating | |
| | 4Vdc | X6T | 150μF | ±20% | GRM32RD80G157ME15# | Derating | |
| | | X5S | 150μF | ±20% | GRM32RC60G157ME15# | | |
| | 2.5Vdc | X6T | 150μF | ±20% | GRM32RD80E157ME15# | | |
| 1.5mm | 50Vdc | X7R | 0.68μF | ±10% | GRM32NR71H684KA01# | | |
| | | B | 0.68μF | ±10% | GRM32NB11H684KA01# | | |
| | 10Vdc | X6S | 22μF | ±20% | GRM32NC81A226ME19# | | |
| 1.8mm | 100Vdc | X7R | 0.68μF | ±10% | GRM32CR72A684KA01# | | |
| | | | 1.0μF | ±10% | GRM32CR72A105KA35# | | |
| 2.2mm | 25Vdc | X7R | 10μF | ±10% | GRM32DR71E106KA12# | | |
| | | X6S | 10μF | ±10% | GRM32DC81E106KA12# | | |
| 2.7mm | 100Vdc | X7R | 2.2μF | ±10% | GRM32ER72A225KA35# | | |
| | | | | ±20% | GRM32ER72A225MA35# | | |
| | | | 4.7μF | ±10% | GRM32ER71H475KA88# | | |
| | | X5R | 10μF | ±10% | GRM32ER61H106KA12# | | |
| | | | | ±20% | GRM32ER61H106MA12# | | |
| | | | B | 4.7μF | ±10% | GRM32EB31H475KA87# | |
| | 35Vdc | X7R | 10μF | ±10% | GRM32ER7YA106KA12# | | |
| | | | | ±10% | GRM32ER6YA106KA12# | | |
| | | | B | 10μF | ±10% | GRM32EB3YA106KA12# | |
| | 25Vdc | X7R | 22μF | ±20% | GRM32ER71E226ME15# | | |
| | | | | ±20% | GRM32EC81E226ME15# | | |
| | | | X5R | 22μF | ±20% | GRM32ER61E226ME15# | |
| | | | | | ±20% | GRM32EB31E226ME15# | |
| | 16Vdc | X7R | 22μF | ±20% | GRM32ER71C226MEA8# | | |
| | | | | ±20% | GRM32EC81C476ME15# | Derating | |
| | | | X5R | 47μF | ±20% | GRM32ER61C476ME15# | |
| | | ±20% | | | GRM32EB31C226ME16# | | |
| | | B | | 47μF | ±20% | GRM32EB31C476ME15# | |
| | | 10Vdc | X7R | 47μF | ±20% | GRM32ER71A476ME15# | |
| | ±20% | | | | GRM32EC81A476ME19# | | |
| | X5R | | | 47μF | ±20% | GRM32ER61A476ME20# | |
| | | | | | ±20% | GRM32EB31A476ME20# | |
| | 6.3Vdc | X7R | 47μF | ±20% | GRM32ER70J476ME20# | | |
| | | | | ±20% | GRM32EE70J107ME15# | Derating | |
| X6S | | | 47μF | ±20% | GRM32EC80J476ME64# | | |
| | | ±20% | | GRM32EC80J107ME20# | | | |
| X5R | | 100μF | ±20% | GRM32ER60J107ME20# | | | |
| | | | B | 100μF | ±20% | GRM32EB30J107ME16# | |
| 4Vdc | | X7U | 100μF | ±20% | GRM32EE70G107ME19# | | |
| | X6S | | | 100μF | ±20% | GRM32EC80G107ME20# | |

For General Purpose
GRM Series

Capacitor Array
GNM Series

Low ESL
LL□ Series

High-Q Type
GJM Series

High Frequency
GQM Series

Monolithic Microchip
GMA Series

For Bonding
GMD Series

Product Information

Chip Monolithic Ceramic Capacitors

Capacitor Array GNM Series

Ideal for reducing the mounting area and mounting costs.

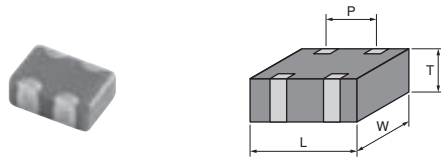

2 Elements

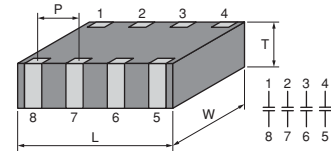
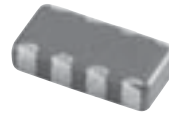

4 Elements

- 1 The number of parts can be reduced.
- 2 Also contributes to the low profile of the set.
- 3 Ideal for decoupling and smoothing.
- 4 Reduction of environmental impact substances is possible.
 (Accommodates 2 or 4 times the number of individual chips per reel.)

For General Purpose
GRM Series

Capacitor Array
GNM Series

Low ESL
LLQ Series

High-Q Type
GJM Series

High Frequency
GQM Series

Monolithic Microchip
GMA Series

For Bonding
GMD Series

Product Information

GNM Series High Dielectric Constant Type Part Number List

■ 2 Elements 0.9x0.6mm

| T max. | Rated Voltage | TC Code | Cap. | Tol. | Part Number |
|--------|---------------|---------|---------|--------------------|--------------------|
| 0.5mm | 16Vdc | X5R | 10000pF | ±20% | GNM0M2R61C103ME18# |
| | | | 22000pF | ±20% | GNM0M2R61C223ME18# |
| | | | 47000pF | ±20% | GNM0M2R61C473ME18# |
| | | | 0.1µF | ±20% | GNM0M2R61C104ME18# |
| | | B | 10000pF | ±20% | GNM0M2B31C103ME18# |
| | | | 22000pF | ±20% | GNM0M2B31C223ME18# |
| | | | 47000pF | ±20% | GNM0M2B31C473ME18# |
| | | | 0.1µF | ±20% | GNM0M2B31C104ME18# |
| | 10Vdc | X5R | 10000pF | ±20% | GNM0M2R61A103ME17# |
| | | | 22000pF | ±20% | GNM0M2R61A223ME17# |
| | | | 47000pF | ±20% | GNM0M2R61A473ME17# |
| | | | 0.1µF | ±20% | GNM0M2R61A104ME17# |
| | | B | 10000pF | ±20% | GNM0M2B31A103ME17# |
| | | | 22000pF | ±20% | GNM0M2B31A223ME17# |
| | | | 47000pF | ±20% | GNM0M2B31A473ME17# |
| | | | 0.1µF | ±20% | GNM0M2B31A104ME17# |
| 4Vdc | X5R | 1.0µF | ±20% | GNM0M2R60G105ME17# | |
| | B | 1.0µF | ±20% | GNM0M2B30G105ME17# | |

■ 2 Elements 1.37x1.0mm

| T max. | Rated Voltage | TC Code | Cap. | Tol. | Part Number |
|--------|---------------|---------|---------|--------------------|--------------------|
| 0.55mm | 16Vdc | X7R | 0.1µF | ±20% | GNM1M2R71C104MAA1# |
| | | R | 0.1µF | ±20% | GNM1M2R11C104MAA1# |
| | | X5R | 1.0µF | ±20% | GNM1M2R61C105MEA2# |
| | | B | 0.1µF | ±20% | GNM1M2B11C104MAA1# |
| | 10Vdc | X5R | 1.0µF | ±20% | GNM1M2R61A105MEA4# |
| 0.7mm | 50Vdc | X7R | 1000pF | ±20% | GNM1M2R71H102MA01# |
| | | R | 1000pF | ±20% | GNM1M2R11H102MA01# |
| | | X5R | 1000pF | ±20% | GNM1M2R61H102MA01# |
| | | B | 1000pF | ±20% | GNM1M2B11H102MA01# |
| | 25Vdc | X7R | 2200pF | ±20% | GNM1M2R71E222MA01# |
| | | | 4700pF | ±20% | GNM1M2R71E472MA01# |
| | | | 10000pF | ±20% | GNM1M2R71E103MA01# |
| | | R | 2200pF | ±20% | GNM1M2R11E222MA01# |
| | | | 4700pF | ±20% | GNM1M2R11E472MA01# |
| | | | 10000pF | ±20% | GNM1M2R11E103MA01# |
| | X5R | 2200pF | ±20% | GNM1M2R61E222MA01# | |
| | | 4700pF | ±20% | GNM1M2R61E472MA01# | |
| | | 10000pF | ±20% | GNM1M2R61E103MA01# | |
| | B | 2200pF | ±20% | GNM1M2B11E222MA01# | |
| | | 4700pF | ±20% | GNM1M2B11E472MA01# | |
| | | 10000pF | ±20% | GNM1M2B11E103MA01# | |
| | 16Vdc | X7R | 22000pF | ±20% | GNM1M2R71C223MA01# |
| | | | 47000pF | ±20% | GNM1M2R71C473MA01# |
| | | | 0.1µF | ±20% | GNM1M2R71C104MA01# |
| | | | R | 22000pF | ±20% |
| | | 47000pF | ±20% | GNM1M2R11C473MA01# | |
| | | 0.1µF | ±20% | GNM1M2R11C104MA01# | |
| X5R | | 22000pF | ±20% | GNM1M2R61C223MA01# | |

| T max. | Rated Voltage | TC Code | Cap. | Tol. | Part Number | | |
|--------|---------------|--------------------|---------|--------------------|--------------------|--------------------|--------------------|
| 0.7mm | 16Vdc | X5R | 47000pF | ±20% | GNM1M2R61C473MA01# | | |
| | | | B | 22000pF | ±20% | GNM1M2B11C223MA01# | |
| | | | 47000pF | ±20% | GNM1M2B11C473MA01# | | |
| | | 0.1µF | ±20% | GNM1M2B11C104MA01# | | | |
| | | 10Vdc | X7R | 22000pF | ±20% | GNM1M2R71A223MA01# | |
| | | | | 47000pF | ±20% | GNM1M2R71A473MA01# | |
| | R | | | 22000pF | ±20% | GNM1M2R11A223MA01# | |
| | 47000pF | | ±20% | GNM1M2R11A473MA01# | | | |
| | X5R | | 22000pF | ±20% | GNM1M2R61A223MA01# | | |
| | | | 47000pF | ±20% | GNM1M2R61A473MA01# | | |
| | | 0.1µF | ±20% | GNM1M2R61A104MA01# | | | |
| | B | 22000pF | ±20% | GNM1M2B11A223MA01# | | | |
| | | 47000pF | ±20% | GNM1M2B11A473MA01# | | | |
| | | 0.1µF | ±20% | GNM1M2B11A104MA01# | | | |
| | | 0.8mm | 16Vdc | X5R | 0.22µF | ±20% | GNM1M2R61C224ME18# |
| | | | | | 1.0µF | ±20% | GNM1M2R61C105ME18# |
| B | | | 1.0µF | ±20% | GNM1M2B31C105ME18# | | |
| | 10Vdc | | X5R | 1.0µF | ±20% | GNM1M2R61A105ME17# | |
| 2.2µF | ±20% | GNM1M2R61A225ME18# | | | | | |
| B | 0.22µF | ±20% | | GNM1M2B31A224ME17# | | | |
| | 0.47µF | ±20% | | GNM1M2B31A474ME17# | | | |
| 1.0µF | ±20% | GNM1M2B31A105ME17# | | | | | |
| 2.2µF | ±20% | GNM1M2B31A225ME18# | | | | | |
| 6.3Vdc | X5R | 2.2µF | ±20% | GNM1M2R60J225ME18# | | | |
| | | B | 2.2µF | ±20% | GNM1M2B30J225ME18# | | |

■ 4 Elements 2.0x1.25mm

| T max. | Rated Voltage | TC Code | Cap. | Tol. | Part Number | |
|---------|---------------|--------------------|--------------------|--------------------|--------------------|--------------------|
| 0.55mm | 16Vdc | X7R | 0.1µF | ±20% | GNM214R71C104MAA1# | |
| | | | R | 0.1µF | ±20% | GNM214R11C104MAA1# |
| | | | B | 0.1µF | ±20% | GNM214B11C104MAA1# |
| | | 10Vdc | X5R | 0.22µF | ±20% | GNM214R61A224MEA2# |
| | | | | 1.0µF | ±20% | GNM214R61A105MEA2# |
| | | | | B | 0.22µF | ±20% |
| | 1.0µF | ±20% | GNM214B31A105MEA2# | | | |
| | | 6.3Vdc | X5R | 0.22µF | ±20% | GNM214R60J224MEA2# |
| | | | | 1.0µF | ±20% | GNM214R60J105MEA2# |
| | B | | | 0.22µF | ±20% | GNM214B30J224MEA2# |
| | 1.0µF | | ±20% | GNM214B30J105MEA2# | | |
| | 0.7mm | | 50Vdc | X7R | 470pF | ±20% |
| 1000pF | | | | | ±20% | GNM214R71H102MA01# |
| R | | 1000pF | | ±20% | GNM214R11H102MA01# | |
| B | | 470pF | ±20% | GNM214B11H471MA01# | | |
| | | 1000pF | ±20% | GNM214B11H102MA01# | | |
| | | 25Vdc | X7R | 2200pF | ±20% | GNM214R71E222MA01# |
| 4700pF | ±20% | GNM214R71E472MA01# | | | | |
| 10000pF | ±20% | GNM214R71E103MA01# | | | | |
| R | 2200pF | ±20% | | GNM214R11E222MA01# | | |
| 4700pF | ±20% | GNM214R11E472MA01# | | | | |
| 10000pF | ±20% | GNM214R11E103MA01# | | | | |
| B | 2200pF | ±20% | GNM214B11E222MA01# | | | |
| | 4700pF | ±20% | GNM214B11E472MA01# | | | |
| | 10000pF | ±20% | GNM214B11E103MA01# | | | |

Part number # indicates the package specification code.

GNM Series High Dielectric Constant Type Part Number List

(→ ■ 4 Elements 2.0×1.25mm)

| T max. | Rated Voltage | TC Code | Cap. | Tol. | Part Number |
|--------|---------------|---------|---------|-------|---------------------------|
| 0.7mm | 25Vdc | B | 10000pF | ±20% | GNM214B11E103MA01# |
| 0.95mm | 16Vdc | X7R | 22000pF | ±20% | GNM214R71C223MA01# |
| | | | 47000pF | ±20% | GNM214R71C473MA01# |
| | | | 0.1μF | ±20% | GNM214R71C104MA01# |
| | | R | 22000pF | ±20% | GNM214R11C223MA01# |
| | | | 47000pF | ±20% | GNM214R11C473MA01# |
| | | | 0.1μF | ±20% | GNM214R11C104MA01# |
| | | B | 22000pF | ±20% | GNM214B11C223MA01# |
| | | | 47000pF | ±20% | GNM214B11C473MA01# |
| | | | 0.1μF | ±20% | GNM214B11C104MA01# |
| | 10Vdc | X5R | 1.0μF | ±20% | GNM214R61A105ME17# |
| | | | B | 1.0μF | ±20% |
| | 6.3Vdc | X5R | 1.0μF | ±20% | GNM214R60J105ME17# |
| B | | | 1.0μF | ±20% | GNM214B30J105ME17# |

For General Purpose GRM Series

Capacitor Array GNM Series

Low ESL LLQ Series

High-Q Type GJM Series

High Frequency GQM Series

Monolithic Microchip GMA Series

For Bonding GMD Series

Product Information

Part number # indicates the package specification code.

Chip Monolithic Ceramic Capacitors

Low ESL LLL/LLR/LLA/LLM Series

**Low
ESL**

LLL Series Ideal decoupling solution for equipment having advanced features.

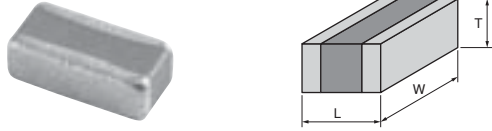

- 1 Ideal for IC decoupling of high-speed operating equipment, due to the low inductance value (ESL value).
- 2 LW reversed geometry type/multi-terminal type and a large lineup of capacitors are available according to performance requirements.

LLR Series Low ESL capacitor that suppresses the anti-resonance in circuits.

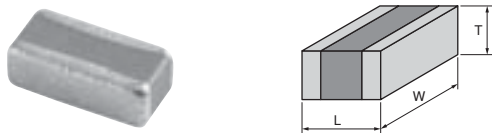

- 1 Reduces the anti-resonance generated in the high-frequency range.
- 2 An optimal ESR value can be selected from four types, according to the characteristics of the circuit.
- 3 The low ESL type, is also ideal as a decoupling component.

LLA Series Ideal decoupling solution for equipment having advanced features.

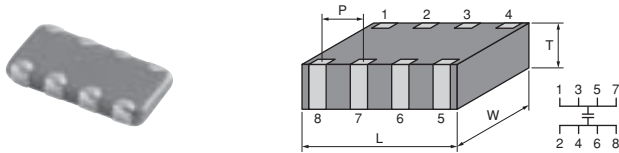

- 1 Ideal for IC decoupling of high-speed operating equipment, due to the low inductance value (ESL value).
- 2 LW reversed geometry type/multi-terminal type and a large lineup of capacitors are available according to performance requirements.

LLM Series Ideal decoupling solution for equipment having advanced features.

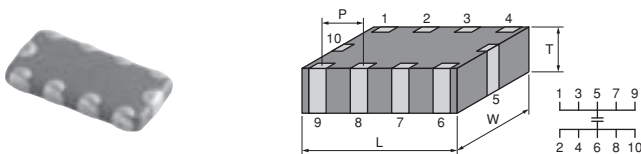

- 1 Ideal for IC decoupling of high-speed operating equipment, due to the low inductance value (ESL value).
- 2 LW reversed geometry type/multi-terminal type and a large lineup of capacitors are available according to performance requirements.

For General Purpose GRM Series
 Capacitor Array GNM Series
 Low ESL LLL Series
 High-Q Type GJM Series
 High Frequency GQM Series
 Monolithic Microchip GMA Series
 For Bonding GMD Series
 Product Information

LLL Series High Dielectric Constant Type Low ESL Part Number List

0.5×1.0mm

| T max. | Rated Voltage | TC Code | Cap. | Tol. | Part Number |
|--------|---------------|---------|--------|------|--------------------|
| 0.35mm | 6.3Vdc | X6S | 0.1μF | ±20% | LLL153C80J104ME01# |
| | | | 0.22μF | ±20% | LLL153C80J224ME14# |
| | 4Vdc | X7S | 0.47μF | ±20% | LLL153C70G474ME17# |

0.8×1.6mm

| T max. | Rated Voltage | TC Code | Cap. | Tol. | Part Number | | |
|--------|---------------|---------|--------------------|--------------------|--------------------|--------------------|--------------------|
| 0.5mm | 25Vdc | X7R | 10000pF | ±20% | LLL185R71E103MA11# | | |
| | | | 16Vdc | X7R | 22000pF | ±20% | LLL185R71C223MA11# |
| | | | 47000pF | | ±20% | LLL185R71C473MA11# | |
| | 10Vdc | X7R | 0.1μF | ±20% | LLL185R71A104MA11# | | |
| | 4Vdc | X7S | 0.22μF | ±20% | LLL185C70G224MA11# | | |
| 0.55mm | 4Vdc | X7S | 1.0μF | ±20% | LLL185C70G105ME01# | | |
| | | | 2.2μF | ±20% | LLL185C70G225ME01# | | |
| 0.6mm | 50Vdc | X7R | 2200pF | ±20% | LLL185R71H222MA01# | | |
| | | | 4700pF | ±20% | LLL185R71H472MA01# | | |
| | | | 10000pF | X7R | ±20% | LLL185R71E103MA01# | |
| | 22000pF | ±20% | LLL185R71E223MA01# | | | | |
| | 16Vdc | X7R | 47000pF | ±20% | LLL185R71C473MA01# | | |
| | 10Vdc | X7R | 0.1μF | ±20% | LLL185R71A104MA01# | | |
| | | | 0.22μF | ±20% | LLL185R71A224MA01# | | |
| 4Vdc | X7S | 0.47μF | ±20% | LLL185C70G474MA01# | | | |

1.25×2.0mm

| T max. | Rated Voltage | TC Code | Cap. | Tol. | Part Number |
|--------|---------------|---------|---------|------|--------------------|
| 0.5mm | 50Vdc | X7R | 10000pF | ±20% | LLL215R71H103MA11# |
| | | | 25Vdc | X7R | 22000pF |
| | 16Vdc | X7R | 47000pF | ±20% | LLL215R71C473MA11# |
| | | | 0.1μF | ±20% | LLL215R71C104MA11# |
| | 10Vdc | X7R | 0.22μF | ±20% | LLL215R71A224MA11# |
| | 6.3Vdc | X7R | 0.47μF | ±20% | LLL215R70J474MA11# |

| T max. | Rated Voltage | TC Code | Cap. | Tol. | Part Number |
|--------|---------------|---------|---------|--------------------|--------------------|
| 0.5mm | 4Vdc | X7S | 1.0μF | ±20% | LLL215C70G105MA11# |
| 0.7mm | 50Vdc | X7R | 10000pF | ±20% | LLL216R71H103MA01# |
| | | | 22000pF | ±20% | LLL216R71H223MA01# |
| | 25Vdc | X7R | 47000pF | ±20% | LLL216R71E473MA01# |
| | | | 0.1μF | ±20% | LLL216R71E104MA01# |
| 10Vdc | X7R | 0.22μF | ±20% | LLL216R71A224MA01# | |
| 0.95mm | 16Vdc | X7R | 0.22μF | ±20% | LLL219R71C224MA01# |
| | 10Vdc | X7R | 0.47μF | ±20% | LLL219R71A474MA01# |
| | | | 1.0μF | ±20% | LLL219R71A105MA01# |
| 4Vdc | X7S | 2.2μF | ±20% | LLL219C70G225MA01# | |

1.6×3.2mm

| T max. | Rated Voltage | TC Code | Cap. | Tol. | Part Number | | |
|--------|---------------|---------|---------|--------------------|--------------------|-------|--------------------|
| 0.5mm | 50Vdc | X7R | 10000pF | ±20% | LLL315R71H103MA11# | | |
| | | | 22000pF | ±20% | LLL315R71H223MA11# | | |
| | | | 25Vdc | X7R | 47000pF | ±20% | LLL315R71E473MA11# |
| | 16Vdc | X7R | 0.1μF | ±20% | LLL315R71E104MA11# | | |
| | | | 0.22μF | ±20% | LLL315R71C224MA11# | | |
| | | | 10Vdc | X7R | 0.47μF | ±20% | LLL315R71A474MA11# |
| 0.8mm | 50Vdc | X7R | 10000pF | ±20% | LLL317R71H103MA01# | | |
| | | | 22000pF | ±20% | LLL317R71H223MA01# | | |
| | | | 47000pF | ±20% | LLL317R71H473MA01# | | |
| | 25Vdc | X7R | 0.1μF | ±20% | LLL317R71E104MA01# | | |
| | 16Vdc | X7R | 0.22μF | ±20% | LLL317R71C224MA01# | | |
| | | | 0.47μF | ±20% | LLL317R71C474MA01# | | |
| | 10Vdc | X7R | 1.0μF | ±20% | LLL317R71A105MA01# | | |
| | | | 6.3Vdc | X7R | 2.2μF | ±20% | LLL317R70J225MA01# |
| | | | 1.25mm | 50Vdc | X7R | 0.1μF | ±20% |
| 25Vdc | X7R | 0.22μF | | | | ±20% | LLL31MR71E224MA01# |
| | | 0.47μF | | | | ±20% | LLL31MR71E474MA01# |
| 16Vdc | X7R | 1.0μF | | ±20% | LLL31MR71C105MA01# | | |
| 10Vdc | X7R | 2.2μF | | ±20% | LLL31MR71A225MA01# | | |
| 6.3Vdc | X7R | 4.7μF | | ±20% | LLL31MR70J475MA01# | | |
| | X5R | 10μF | ±20% | LLL31MR60J106ME01# | | | |

LLR Series High Dielectric Constant Type Low ESL Part Number List

0.8×1.6mm

| T max. | Rated Voltage | TC Code | Cap. | Tol. | ESR | Part Number |
|--------|---------------|---------|-------|------|--------|--------------------|
| 0.55mm | 4Vdc | X7S | 1.0μF | ±20% | 100mΩ | LLR185C70G105ME01# |
| | | | | ±20% | 220mΩ | LLR185C70G105ME03# |
| | | | | ±20% | 470mΩ | LLR185C70G105ME05# |
| | | | | ±20% | 1000mΩ | LLR185C70G105ME07# |

Part number # indicates the package specification code.

LLA Series High Dielectric Constant Type Low ESL Part Number List

■ 1.6×0.8mm

| T max. | Rated Voltage | TC Code | Cap. | Tol. | Part Number |
|--------|---------------|---------|--------|------|--------------------|
| 0.55mm | 4Vdc | X7S | 0.1μF | ±20% | LLA185C70G104MA01# |
| | | | 0.22μF | ±20% | LLA185C70G224MA01# |
| | | | 0.47μF | ±20% | LLA185C70G474MA01# |
| | | | 1.0μF | ±20% | LLA185C70G105ME01# |
| | | | 2.2μF | ±20% | LLA185C70G225ME16# |

■ 2.0×1.25mm

| T max. | Rated Voltage | TC Code | Cap. | Tol. | Part Number | |
|--------|---------------|---------|---------|---------|--------------------|--------------------|
| 0.55mm | 25Vdc | X7R | 10000pF | ±20% | LLA215R71E103MA14# | |
| | | | 22000pF | ±20% | LLA215R71E223MA14# | |
| | 16Vdc | X7R | 47000pF | ±20% | LLA215R71C473MA14# | |
| | | | 0.1μF | ±20% | LLA215R71C104MA14# | |
| | 10Vdc | X7R | 0.22μF | ±20% | LLA215R71A224MA14# | |
| | 6.3Vdc | X7R | 0.47μF | ±20% | LLA215R70J474MA14# | |
| | 4Vdc | X7S | 1.0μF | ±20% | LLA215C70G105MA14# | |
| | | | 2.2μF | ±20% | LLA215C70G225ME11# | |
| | | | 4.7μF | ±20% | LLA215C70G475ME19# | |
| | 0.95mm | 25Vdc | X7R | 10000pF | ±20% | LLA219R71E103MA01# |

| T max. | Rated Voltage | TC Code | Cap. | Tol. | Part Number |
|--------|---------------|---------|---------|------|--------------------|
| 0.95mm | 25Vdc | X7R | 22000pF | ±20% | LLA219R71E223MA01# |
| | | | 47000pF | ±20% | LLA219R71E473MA01# |
| | 16Vdc | X7R | 0.1μF | ±20% | LLA219R71C104MA01# |
| | | | 0.22μF | ±20% | LLA219R71C224MA01# |
| | 10Vdc | X7R | 0.47μF | ±20% | LLA219R71A474MA01# |
| | 6.3Vdc | X7R | 1.0μF | ±20% | LLA219R70J105MA01# |
| | 4Vdc | X7S | 2.2μF | ±20% | LLA219C70G225MA01# |
| | | | 4.7μF | ±20% | LLA219C70G475ME01# |

■ 3.2×1.6mm

| T max. | Rated Voltage | TC Code | Cap. | Tol. | Part Number |
|--------|---------------|---------|--------|------|--------------------|
| 0.55mm | 16Vdc | X7R | 0.22μF | ±20% | LLA315R71C224MA14# |
| | | | 0.47μF | ±20% | LLA315R71A474MA14# |
| | 6.3Vdc | X7R | 1.0μF | ±20% | LLA315R70J105MA14# |
| | | | 2.2μF | ±20% | LLA315R70J225MA14# |
| 0.95mm | 16Vdc | X7R | 0.47μF | ±20% | LLA319R71C474MA01# |
| | | | 10Vdc | X7R | 1.0μF |
| 1.25mm | 16Vdc | X7R | 1.0μF | ±20% | LLA31MR71C105MA01# |
| | | | 10Vdc | X7R | 2.2μF |

LLM Series High Dielectric Constant Type Low ESL Part Number List

■ 2.0×1.25mm

| T max. | Rated Voltage | TC Code | Cap. | Tol. | Part Number |
|--------|---------------|---------|---------|------|--------------------|
| 0.55mm | 25Vdc | X7R | 10000pF | ±20% | LLM215R71E103MA11# |
| | | | 22000pF | ±20% | LLM215R71E223MA11# |
| | 16Vdc | X7R | 47000pF | ±20% | LLM215R71C473MA11# |
| | | | 0.1μF | ±20% | LLM215R71C104MA11# |
| | 6.3Vdc | X7R | 0.22μF | ±20% | LLM215R70J224MA11# |
| | | | 0.47μF | ±20% | LLM215R70J474MA11# |
| | 4Vdc | X7S | 1.0μF | ±20% | LLM215C70G105MA11# |
| | | | 2.2μF | ±20% | LLM215C70G225ME11# |

■ 3.2×1.6mm

| T max. | Rated Voltage | TC Code | Cap. | Tol. | Part Number |
|--------|---------------|---------|--------|------|--------------------|
| 0.55mm | 16Vdc | X7R | 0.1μF | ±20% | LLM315R71C104MA11# |
| | | | 0.22μF | ±20% | LLM315R71C224MA11# |
| | 10Vdc | X7R | 0.47μF | ±20% | LLM315R71A474MA11# |
| | 6.3Vdc | X7R | 2.2μF | ±20% | LLM315R70J225MA11# |

For General Purpose GRM Series
 Capacitor Array GNM Series
 Low ESL LLM Series
 High-Q Type GJM Series
 High Frequency GQM Series
 Monolithic Microchip GMA Series
 For Bonding GMD Series
 Product Information

Chip Monolithic Ceramic Capacitors

High-Q Type GJM Series

HiQ

Contributes to improvements in the reduction of power consumption and processing yield by HiQ or low ESR.

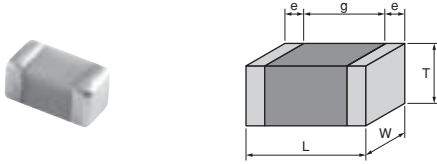

- 1 Ideal for high-frequency decoupling applications.
- 2 HiQ and low ESR in VHF, UHF and microwave frequency bands.
- 3 Compatible to tight tolerances.

For General Purpose
GRW Series

Capacitor Array
GJM Series

Low ESL
LLQ Series

High-Q Type
GJM Series

High Frequency
GQM Series

Monolithic Microchip
GMA Series

For Bonding
GMD Series

Product Information

GJM Series Temperature Compensating Type HiQ Part Number List

■ 0.4x0.2mm Ultra-compact

| T max. | Rated Voltage | TC Code | Cap. | Tol. | Part Number |
|---------|--------------------|--------------------|-------|---------|--------------------|
| 0.22mm | 16Vdc | C0G | 0.2pF | ±0.05pF | GJM0225C1CR20WB01# |
| | | | | ±0.1pF | GJM0225C1CR20BB01# |
| | | | 0.3pF | ±0.05pF | GJM0225C1CR30WB01# |
| | | | | ±0.1pF | GJM0225C1CR30BB01# |
| | | | 0.4pF | ±0.05pF | GJM0225C1CR40WB01# |
| | | | | ±0.1pF | GJM0225C1CR40BB01# |
| | | | 0.5pF | ±0.05pF | GJM0225C1CR50WB01# |
| | | | | ±0.1pF | GJM0225C1CR50BB01# |
| | | | 0.6pF | ±0.05pF | GJM0225C1CR60WB01# |
| | | | | ±0.1pF | GJM0225C1CR60BB01# |
| | | | 0.7pF | ±0.05pF | GJM0225C1CR70WB01# |
| | | | | ±0.1pF | GJM0225C1CR70BB01# |
| | | | 0.8pF | ±0.05pF | GJM0225C1CR80WB01# |
| | | | | ±0.1pF | GJM0225C1CR80BB01# |
| | | | 0.9pF | ±0.05pF | GJM0225C1CR90WB01# |
| | | | | ±0.1pF | GJM0225C1CR90BB01# |
| | | | 1.0pF | ±0.05pF | GJM0225C1C1R0WB01# |
| | | | | ±0.1pF | GJM0225C1C1R0BB01# |
| | | | | ±0.25pF | GJM0225C1C1R0CB01# |
| | | | 1.1pF | ±0.05pF | GJM0225C1C1R1WB01# |
| | | | | ±0.1pF | GJM0225C1C1R1BB01# |
| | | | | ±0.25pF | GJM0225C1C1R1CB01# |
| | | | 1.2pF | ±0.05pF | GJM0225C1C1R2WB01# |
| | | | | ±0.1pF | GJM0225C1C1R2BB01# |
| | | | | ±0.25pF | GJM0225C1C1R2CB01# |
| | | | 1.3pF | ±0.05pF | GJM0225C1C1R3WB01# |
| | | | | ±0.1pF | GJM0225C1C1R3BB01# |
| | | | | ±0.25pF | GJM0225C1C1R3CB01# |
| | | | 1.4pF | ±0.05pF | GJM0225C1C1R4WB01# |
| | | | | ±0.1pF | GJM0225C1C1R4BB01# |
| | | | | ±0.25pF | GJM0225C1C1R4CB01# |
| | | | 1.5pF | ±0.05pF | GJM0225C1C1R5WB01# |
| | | | | ±0.1pF | GJM0225C1C1R5BB01# |
| | | | | ±0.25pF | GJM0225C1C1R5CB01# |
| | | | 1.6pF | ±0.05pF | GJM0225C1C1R6WB01# |
| | | | | ±0.1pF | GJM0225C1C1R6BB01# |
| | | | | ±0.25pF | GJM0225C1C1R6CB01# |
| | | | 1.7pF | ±0.05pF | GJM0225C1C1R7WB01# |
| | | | | ±0.1pF | GJM0225C1C1R7BB01# |
| | | | | ±0.25pF | GJM0225C1C1R7CB01# |
| | | | 1.8pF | ±0.05pF | GJM0225C1C1R8WB01# |
| | | | | ±0.1pF | GJM0225C1C1R8BB01# |
| | | | | ±0.25pF | GJM0225C1C1R8CB01# |
| | | | 1.9pF | ±0.05pF | GJM0225C1C1R9WB01# |
| | | | | ±0.1pF | GJM0225C1C1R9BB01# |
| | | | | ±0.25pF | GJM0225C1C1R9CB01# |
| | | | 2.0pF | ±0.05pF | GJM0225C1C2R0WB01# |
| | | | | ±0.1pF | GJM0225C1C2R0BB01# |
| ±0.25pF | GJM0225C1C2R0CB01# | | | | |
| 2.1pF | ±0.05pF | GJM0225C1C2R1WB01# | | | |
| | ±0.1pF | GJM0225C1C2R1BB01# | | | |
| | ±0.25pF | GJM0225C1C2R1CB01# | | | |

| T max. | Rated Voltage | TC Code | Cap. | Tol. | Part Number |
|--------|---------------|--------------------|-------|---------|--------------------|
| 0.22mm | 16Vdc | C0G | 2.2pF | ±0.05pF | GJM0225C1C2R2WB01# |
| | | | | ±0.1pF | GJM0225C1C2R2BB01# |
| | | | | ±0.25pF | GJM0225C1C2R2CB01# |
| | | | 2.3pF | ±0.05pF | GJM0225C1C2R3WB01# |
| | | | | ±0.1pF | GJM0225C1C2R3BB01# |
| | | | | ±0.25pF | GJM0225C1C2R3CB01# |
| | | | 2.4pF | ±0.05pF | GJM0225C1C2R4WB01# |
| | | | | ±0.1pF | GJM0225C1C2R4BB01# |
| | | | | ±0.25pF | GJM0225C1C2R4CB01# |
| | | | 2.5pF | ±0.05pF | GJM0225C1C2R5WB01# |
| | | | | ±0.1pF | GJM0225C1C2R5BB01# |
| | | | | ±0.25pF | GJM0225C1C2R5CB01# |
| | | | 2.6pF | ±0.05pF | GJM0225C1C2R6WB01# |
| | | | | ±0.1pF | GJM0225C1C2R6BB01# |
| | | | | ±0.25pF | GJM0225C1C2R6CB01# |
| | | | 2.7pF | ±0.05pF | GJM0225C1C2R7WB01# |
| | | | | ±0.1pF | GJM0225C1C2R7BB01# |
| | | | | ±0.25pF | GJM0225C1C2R7CB01# |
| | | | 2.8pF | ±0.05pF | GJM0225C1C2R8WB01# |
| | | | | ±0.1pF | GJM0225C1C2R8BB01# |
| | | | | ±0.25pF | GJM0225C1C2R8CB01# |
| | | | 2.9pF | ±0.05pF | GJM0225C1C2R9WB01# |
| | | | | ±0.1pF | GJM0225C1C2R9BB01# |
| | | | | ±0.25pF | GJM0225C1C2R9CB01# |
| | | | 3.0pF | ±0.05pF | GJM0225C1C3R0WB01# |
| | | | | ±0.1pF | GJM0225C1C3R0BB01# |
| | | | | ±0.25pF | GJM0225C1C3R0CB01# |
| | | | 3.1pF | ±0.05pF | GJM0225C1C3R1WB01# |
| | | | | ±0.1pF | GJM0225C1C3R1BB01# |
| | | | | ±0.25pF | GJM0225C1C3R1CB01# |
| | | | 3.2pF | ±0.05pF | GJM0225C1C3R2WB01# |
| | | | | ±0.1pF | GJM0225C1C3R2BB01# |
| | | | | ±0.25pF | GJM0225C1C3R2CB01# |
| | | | 3.3pF | ±0.05pF | GJM0225C1C3R3WB01# |
| | | | | ±0.1pF | GJM0225C1C3R3BB01# |
| | | | | ±0.25pF | GJM0225C1C3R3CB01# |
| | | | 3.4pF | ±0.05pF | GJM0225C1C3R4WB01# |
| | | | | ±0.1pF | GJM0225C1C3R4BB01# |
| | | | | ±0.25pF | GJM0225C1C3R4CB01# |
| | | | 3.5pF | ±0.05pF | GJM0225C1C3R5WB01# |
| | | | | ±0.1pF | GJM0225C1C3R5BB01# |
| | | | | ±0.25pF | GJM0225C1C3R5CB01# |
| | | | 3.6pF | ±0.05pF | GJM0225C1C3R6WB01# |
| | | | | ±0.1pF | GJM0225C1C3R6BB01# |
| | | | | ±0.25pF | GJM0225C1C3R6CB01# |
| | | | 3.7pF | ±0.05pF | GJM0225C1C3R7WB01# |
| | | | | ±0.1pF | GJM0225C1C3R7BB01# |
| | | | | ±0.25pF | GJM0225C1C3R7CB01# |
| 3.8pF | ±0.05pF | GJM0225C1C3R8WB01# | | | |
| | ±0.1pF | GJM0225C1C3R8BB01# | | | |
| | ±0.25pF | GJM0225C1C3R8CB01# | | | |
| 3.9pF | ±0.05pF | GJM0225C1C3R9WB01# | | | |
| | ±0.1pF | GJM0225C1C3R9BB01# | | | |
| | ±0.25pF | GJM0225C1C3R9CB01# | | | |

For General Purpose GRM Series
 Capacitor Array GNM Series
 Low ESL LL Series
 High-Q Type GJM Series
 High Frequency GQM Series
 Monolithic Microchip GMA Series
 For Bonding GMD Series
 Product Information

Part number # indicates the package specification code.

GJM Series Temperature Compensating Type HiQ Part Number List

(→ ■ 0.4x0.2mm)

| T max. | Rated Voltage | TC Code | Cap. | Tol. | Part Number |
|--------|---------------|---------|-------|---------|---------------------------|
| 0.22mm | 16Vdc | C0G | 4.0pF | ±0.05pF | GJM0225C1C4R0WB01# |
| | | | | ±0.1pF | GJM0225C1C4R0BB01# |
| | | | | ±0.25pF | GJM0225C1C4R0CB01# |
| | | | 4.1pF | ±0.05pF | GJM0225C1C4R1WB01# |
| | | | | ±0.1pF | GJM0225C1C4R1BB01# |
| | | | | ±0.25pF | GJM0225C1C4R1CB01# |
| | | | 4.2pF | ±0.05pF | GJM0225C1C4R2WB01# |
| | | | | ±0.1pF | GJM0225C1C4R2BB01# |
| | | | | ±0.25pF | GJM0225C1C4R2CB01# |
| | | | 4.3pF | ±0.05pF | GJM0225C1C4R3WB01# |
| | | | | ±0.1pF | GJM0225C1C4R3BB01# |
| | | | | ±0.25pF | GJM0225C1C4R3CB01# |
| | | | 4.4pF | ±0.05pF | GJM0225C1C4R4WB01# |
| | | | | ±0.1pF | GJM0225C1C4R4BB01# |
| | | | | ±0.25pF | GJM0225C1C4R4CB01# |
| | | | 4.5pF | ±0.05pF | GJM0225C1C4R5WB01# |
| | | | | ±0.1pF | GJM0225C1C4R5BB01# |
| | | | | ±0.25pF | GJM0225C1C4R5CB01# |
| | | | 4.6pF | ±0.05pF | GJM0225C1C4R6WB01# |
| | | | | ±0.1pF | GJM0225C1C4R6BB01# |
| | | | | ±0.25pF | GJM0225C1C4R6CB01# |
| | | | 4.7pF | ±0.05pF | GJM0225C1C4R7WB01# |
| | | | | ±0.1pF | GJM0225C1C4R7BB01# |
| | | | | ±0.25pF | GJM0225C1C4R7CB01# |
| | | | 4.8pF | ±0.05pF | GJM0225C1C4R8WB01# |
| | | | | ±0.1pF | GJM0225C1C4R8BB01# |
| | | | | ±0.25pF | GJM0225C1C4R8CB01# |
| | | | 4.9pF | ±0.05pF | GJM0225C1C4R9WB01# |
| | | | | ±0.1pF | GJM0225C1C4R9BB01# |
| | | | | ±0.25pF | GJM0225C1C4R9CB01# |
| | | | 5.0pF | ±0.05pF | GJM0225C1C5R0WB01# |
| | | | | ±0.1pF | GJM0225C1C5R0BB01# |
| | | | | ±0.25pF | GJM0225C1C5R0CB01# |
| | | | 5.1pF | ±0.05pF | GJM0225C1C5R1WB01# |
| | | | | ±0.1pF | GJM0225C1C5R1BB01# |
| | | | | ±0.25pF | GJM0225C1C5R1CB01# |
| | | | | ±0.5pF | GJM0225C1C5R1DB01# |
| | | | 5.2pF | ±0.05pF | GJM0225C1C5R2WB01# |
| | | | | ±0.1pF | GJM0225C1C5R2BB01# |
| | | | | ±0.25pF | GJM0225C1C5R2CB01# |
| | | | | ±0.5pF | GJM0225C1C5R2DB01# |
| | | | 5.3pF | ±0.05pF | GJM0225C1C5R3WB01# |
| | | | | ±0.1pF | GJM0225C1C5R3BB01# |
| | | | | ±0.25pF | GJM0225C1C5R3CB01# |
| | | | | ±0.5pF | GJM0225C1C5R3DB01# |
| | | | 5.4pF | ±0.05pF | GJM0225C1C5R4WB01# |
| | | | | ±0.1pF | GJM0225C1C5R4BB01# |
| | | | | ±0.25pF | GJM0225C1C5R4CB01# |
| | | | | ±0.5pF | GJM0225C1C5R4DB01# |
| | | | 5.5pF | ±0.05pF | GJM0225C1C5R5WB01# |
| | | | | ±0.1pF | GJM0225C1C5R5BB01# |
| | | | | ±0.25pF | GJM0225C1C5R5CB01# |
| | | | | ±0.5pF | GJM0225C1C5R5DB01# |
| | | | 5.6pF | ±0.05pF | GJM0225C1C5R6WB01# |

| T max. | Rated Voltage | TC Code | Cap. | Tol. | Part Number |
|--------|---------------|---------|-------|---------|---------------------------|
| 0.22mm | 16Vdc | C0G | 5.6pF | ±0.1pF | GJM0225C1C5R6BB01# |
| | | | | ±0.25pF | GJM0225C1C5R6CB01# |
| | | | | ±0.5pF | GJM0225C1C5R6DB01# |
| | | | 5.7pF | ±0.05pF | GJM0225C1C5R7WB01# |
| | | | | ±0.1pF | GJM0225C1C5R7BB01# |
| | | | | ±0.25pF | GJM0225C1C5R7CB01# |
| | | | 5.8pF | ±0.05pF | GJM0225C1C5R8WB01# |
| | | | | ±0.1pF | GJM0225C1C5R8BB01# |
| | | | | ±0.25pF | GJM0225C1C5R8CB01# |
| | | | 5.9pF | ±0.05pF | GJM0225C1C5R9WB01# |
| | | | | ±0.1pF | GJM0225C1C5R9BB01# |
| | | | | ±0.25pF | GJM0225C1C5R9CB01# |
| | | | 6.0pF | ±0.05pF | GJM0225C1C6R0WB01# |
| | | | | ±0.1pF | GJM0225C1C6R0BB01# |
| | | | | ±0.25pF | GJM0225C1C6R0CB01# |
| | | | 6.1pF | ±0.05pF | GJM0225C1C6R1WB01# |
| | | | | ±0.1pF | GJM0225C1C6R1BB01# |
| | | | | ±0.25pF | GJM0225C1C6R1CB01# |
| | | | 6.2pF | ±0.05pF | GJM0225C1C6R2WB01# |
| | | | | ±0.1pF | GJM0225C1C6R2BB01# |
| | | | | ±0.25pF | GJM0225C1C6R2CB01# |
| | | | 6.3pF | ±0.05pF | GJM0225C1C6R3WB01# |
| | | | | ±0.1pF | GJM0225C1C6R3BB01# |
| | | | | ±0.25pF | GJM0225C1C6R3CB01# |
| | | | 6.4pF | ±0.05pF | GJM0225C1C6R4WB01# |
| | | | | ±0.1pF | GJM0225C1C6R4BB01# |
| | | | | ±0.25pF | GJM0225C1C6R4CB01# |
| | | | 6.5pF | ±0.05pF | GJM0225C1C6R5WB01# |
| | | | | ±0.1pF | GJM0225C1C6R5BB01# |
| | | | | ±0.25pF | GJM0225C1C6R5CB01# |
| | | | 6.6pF | ±0.05pF | GJM0225C1C6R6WB01# |
| | | | | ±0.1pF | GJM0225C1C6R6BB01# |
| | | | | ±0.25pF | GJM0225C1C6R6CB01# |
| | | | 6.7pF | ±0.05pF | GJM0225C1C6R7WB01# |
| | | | | ±0.1pF | GJM0225C1C6R7BB01# |
| | | | | ±0.25pF | GJM0225C1C6R7CB01# |
| | | | 6.8pF | ±0.05pF | GJM0225C1C6R8WB01# |
| | | | | ±0.1pF | GJM0225C1C6R8BB01# |
| | | | | ±0.25pF | GJM0225C1C6R8CB01# |
| | | | 6.9pF | ±0.05pF | GJM0225C1C6R9WB01# |
| | | | | ±0.1pF | GJM0225C1C6R9BB01# |
| | | | | ±0.25pF | GJM0225C1C6R9CB01# |

Part number # indicates the package specification code.

For General Purpose GRM Series
 Capacitor Array GNM Series
 Low ESL LLI Series
 High-Q Type GMI Series
 High Frequency GQM Series
 Monolithic Microchip GMA Series
 For Bonding GMD Series
 Product Information

GJM Series Temperature Compensating Type HiQ Part Number List

(→ ■ 0.4x0.2mm)

| T max. | Rated Voltage | TC Code | Cap. | Tol. | Part Number |
|--------|---------------|---------|---------|---------|---------------------------|
| 0.22mm | 16Vdc | C0G | 6.9pF | ±0.5pF | GJM0225C1C6R9DB01# |
| | | | | ±0.05pF | GJM0225C1C7R0WB01# |
| | | | 7.0pF | ±0.1pF | GJM0225C1C7R0BB01# |
| | | | | ±0.25pF | GJM0225C1C7R0CB01# |
| | | | | ±0.5pF | GJM0225C1C7R0DB01# |
| | | | | 7.1pF | ±0.05pF |
| | | | ±0.1pF | | GJM0225C1C7R1BB01# |
| | | | ±0.25pF | | GJM0225C1C7R1CB01# |
| | | | ±0.5pF | | GJM0225C1C7R1DB01# |
| | | | 7.2pF | ±0.05pF | GJM0225C1C7R2WB01# |
| | | | | ±0.1pF | GJM0225C1C7R2BB01# |
| | | | | ±0.25pF | GJM0225C1C7R2CB01# |
| | | | | ±0.5pF | GJM0225C1C7R2DB01# |
| | | | 7.3pF | ±0.05pF | GJM0225C1C7R3WB01# |
| | | | | ±0.1pF | GJM0225C1C7R3BB01# |
| | | | | ±0.25pF | GJM0225C1C7R3CB01# |
| | | | | ±0.5pF | GJM0225C1C7R3DB01# |
| | | | 7.4pF | ±0.05pF | GJM0225C1C7R4WB01# |
| | | | | ±0.1pF | GJM0225C1C7R4BB01# |
| | | | | ±0.25pF | GJM0225C1C7R4CB01# |
| | | | | ±0.5pF | GJM0225C1C7R4DB01# |
| | | | 7.5pF | ±0.05pF | GJM0225C1C7R5WB01# |
| | | | | ±0.1pF | GJM0225C1C7R5BB01# |
| | | | | ±0.25pF | GJM0225C1C7R5CB01# |
| | | | | ±0.5pF | GJM0225C1C7R5DB01# |
| | | | 7.6pF | ±0.05pF | GJM0225C1C7R6WB01# |
| | | | | ±0.1pF | GJM0225C1C7R6BB01# |
| | | | | ±0.25pF | GJM0225C1C7R6CB01# |
| | | | | ±0.5pF | GJM0225C1C7R6DB01# |
| | | | 7.7pF | ±0.05pF | GJM0225C1C7R7WB01# |
| | | | | ±0.1pF | GJM0225C1C7R7BB01# |
| | | | | ±0.25pF | GJM0225C1C7R7CB01# |
| | | | | ±0.5pF | GJM0225C1C7R7DB01# |
| | | | 7.8pF | ±0.05pF | GJM0225C1C7R8WB01# |
| | | | | ±0.1pF | GJM0225C1C7R8BB01# |
| | | | | ±0.25pF | GJM0225C1C7R8CB01# |
| | | | | ±0.5pF | GJM0225C1C7R8DB01# |
| | | | 7.9pF | ±0.05pF | GJM0225C1C7R9WB01# |
| | | | | ±0.1pF | GJM0225C1C7R9BB01# |
| | | | | ±0.25pF | GJM0225C1C7R9CB01# |
| | | | | ±0.5pF | GJM0225C1C7R9DB01# |
| | | | 8.0pF | ±0.05pF | GJM0225C1C8R0WB01# |
| | | | | ±0.1pF | GJM0225C1C8R0BB01# |
| | | | | ±0.25pF | GJM0225C1C8R0CB01# |
| | | | | ±0.5pF | GJM0225C1C8R0DB01# |
| | | | 8.1pF | ±0.05pF | GJM0225C1C8R1WB01# |
| | | | | ±0.1pF | GJM0225C1C8R1BB01# |
| | | | | ±0.25pF | GJM0225C1C8R1CB01# |
| | | | | ±0.5pF | GJM0225C1C8R1DB01# |
| | | | 8.2pF | ±0.05pF | GJM0225C1C8R2WB01# |
| | | | | ±0.1pF | GJM0225C1C8R2BB01# |
| | | | | ±0.25pF | GJM0225C1C8R2CB01# |
| | | | | ±0.5pF | GJM0225C1C8R2DB01# |
| | | | 8.3pF | ±0.05pF | GJM0225C1C8R3WB01# |

| T max. | Rated Voltage | TC Code | Cap. | Tol. | Part Number |
|--------|---------------|---------|-------|---------|---------------------------|
| 0.22mm | 16Vdc | C0G | 8.3pF | ±0.1pF | GJM0225C1C8R3BB01# |
| | | | | ±0.25pF | GJM0225C1C8R3CB01# |
| | | | | ±0.5pF | GJM0225C1C8R3DB01# |
| | | | 8.4pF | ±0.05pF | GJM0225C1C8R4WB01# |
| | | | | ±0.1pF | GJM0225C1C8R4BB01# |
| | | | | ±0.25pF | GJM0225C1C8R4CB01# |
| | | | 8.5pF | ±0.05pF | GJM0225C1C8R5WB01# |
| | | | | ±0.1pF | GJM0225C1C8R5BB01# |
| | | | | ±0.25pF | GJM0225C1C8R5CB01# |
| | | | 8.6pF | ±0.05pF | GJM0225C1C8R6WB01# |
| | | | | ±0.1pF | GJM0225C1C8R6BB01# |
| | | | | ±0.25pF | GJM0225C1C8R6CB01# |
| | | | 8.7pF | ±0.05pF | GJM0225C1C8R7WB01# |
| | | | | ±0.1pF | GJM0225C1C8R7BB01# |
| | | | | ±0.25pF | GJM0225C1C8R7CB01# |
| | | | 8.8pF | ±0.05pF | GJM0225C1C8R8WB01# |
| | | | | ±0.1pF | GJM0225C1C8R8BB01# |
| | | | | ±0.25pF | GJM0225C1C8R8CB01# |
| | | | 8.9pF | ±0.05pF | GJM0225C1C8R9WB01# |
| | | | | ±0.1pF | GJM0225C1C8R9BB01# |
| | | | | ±0.25pF | GJM0225C1C8R9CB01# |
| | | | 9.0pF | ±0.05pF | GJM0225C1C9R0WB01# |
| | | | | ±0.1pF | GJM0225C1C9R0BB01# |
| | | | | ±0.25pF | GJM0225C1C9R0CB01# |
| | | | 9.1pF | ±0.05pF | GJM0225C1C9R1WB01# |
| | | | | ±0.1pF | GJM0225C1C9R1BB01# |
| | | | | ±0.25pF | GJM0225C1C9R1CB01# |
| | | | 9.2pF | ±0.05pF | GJM0225C1C9R2WB01# |
| | | | | ±0.1pF | GJM0225C1C9R2BB01# |
| | | | | ±0.25pF | GJM0225C1C9R2CB01# |
| | | | 9.3pF | ±0.05pF | GJM0225C1C9R3WB01# |
| | | | | ±0.1pF | GJM0225C1C9R3BB01# |
| | | | | ±0.25pF | GJM0225C1C9R3CB01# |
| | | | 9.4pF | ±0.05pF | GJM0225C1C9R4WB01# |
| | | | | ±0.1pF | GJM0225C1C9R4BB01# |
| | | | | ±0.25pF | GJM0225C1C9R4CB01# |
| | | | 9.5pF | ±0.05pF | GJM0225C1C9R5WB01# |
| | | | | ±0.1pF | GJM0225C1C9R5BB01# |
| | | | | ±0.25pF | GJM0225C1C9R5CB01# |
| | | | 9.6pF | ±0.05pF | GJM0225C1C9R6WB01# |
| | | | | ±0.1pF | GJM0225C1C9R6BB01# |
| | | | | ±0.25pF | GJM0225C1C9R6CB01# |

For General Purpose GRM Series

Capacitor Array GNM Series

Low ESL LLM Series

High-Q Type GJM Series

High Frequency GQM Series

Monolithic Microchip GMA Series

For Bonding GMD Series

Product Information

Part number # indicates the package specification code.

GJM Series Temperature Compensating Type HiQ Part Number List

(→ ■ 0.4x0.2mm)

| T max. | Rated Voltage | TC Code | Cap. | Tol. | Part Number | |
|---------|--------------------|--------------------|---------|--------------------|--------------------|--------------------|
| 0.22mm | 16Vdc | C0G | 9.6pF | ±0.5pF | GJM0225C1C9R6DB01# | |
| | | | | ±0.05pF | GJM0225C1C9R7WB01# | |
| | | | | | ±0.1pF | GJM0225C1C9R7BB01# |
| | | | | | ±0.25pF | GJM0225C1C9R7CB01# |
| | | | | | ±0.5pF | GJM0225C1C9R7DB01# |
| | | | 9.8pF | ±0.05pF | GJM0225C1C9R8WB01# | |
| | | | | ±0.1pF | GJM0225C1C9R8BB01# | |
| | | | | ±0.25pF | GJM0225C1C9R8CB01# | |
| | | | | ±0.5pF | GJM0225C1C9R8DB01# | |
| | | | | 9.9pF | ±0.05pF | GJM0225C1C9R9WB01# |
| | | | | | ±0.1pF | GJM0225C1C9R9BB01# |
| | | | ±0.25pF | | GJM0225C1C9R9CB01# | |
| | | | ±0.5pF | | GJM0225C1C9R9DB01# | |
| | | | 10pF | ±2% | GJM0225C1C100GB01# | |
| | | | | ±5% | GJM0225C1C100JB01# | |
| | | | CK | 0.2pF | ±0.05pF | GJM0224C1CR20WB01# |
| | | | | | ±0.1pF | GJM0224C1CR20BB01# |
| | | | | 0.3pF | ±0.05pF | GJM0224C1CR30WB01# |
| | | | | | ±0.1pF | GJM0224C1CR30BB01# |
| | | | | 0.4pF | ±0.05pF | GJM0224C1CR40WB01# |
| | | | | | ±0.1pF | GJM0224C1CR40BB01# |
| | | | | 0.5pF | ±0.05pF | GJM0224C1CR50WB01# |
| | | | | | ±0.1pF | GJM0224C1CR50BB01# |
| | | | | 0.6pF | ±0.05pF | GJM0224C1CR60WB01# |
| | | | | | ±0.1pF | GJM0224C1CR60BB01# |
| | | 0.7pF | | ±0.05pF | GJM0224C1CR70WB01# | |
| | | | | ±0.1pF | GJM0224C1CR70BB01# | |
| | | 0.8pF | | ±0.05pF | GJM0224C1CR80WB01# | |
| | | | | ±0.1pF | GJM0224C1CR80BB01# | |
| | | 0.9pF | | ±0.05pF | GJM0224C1CR90WB01# | |
| | | | | ±0.1pF | GJM0224C1CR90BB01# | |
| | | 1.0pF | | ±0.05pF | GJM0224C1C1R0WB01# | |
| | | | | ±0.1pF | GJM0224C1C1R0BB01# | |
| | | | | ±0.25pF | GJM0224C1C1R0CB01# | |
| | | 1.1pF | | ±0.05pF | GJM0224C1C1R1WB01# | |
| | | | | ±0.1pF | GJM0224C1C1R1BB01# | |
| | | | | ±0.25pF | GJM0224C1C1R1CB01# | |
| | | 1.2pF | | ±0.05pF | GJM0224C1C1R2WB01# | |
| | | | | ±0.1pF | GJM0224C1C1R2BB01# | |
| | | | | ±0.25pF | GJM0224C1C1R2CB01# | |
| | | 1.3pF | ±0.05pF | GJM0224C1C1R3WB01# | | |
| | | | ±0.1pF | GJM0224C1C1R3BB01# | | |
| | | | ±0.25pF | GJM0224C1C1R3CB01# | | |
| | | 1.4pF | ±0.05pF | GJM0224C1C1R4WB01# | | |
| | | | ±0.1pF | GJM0224C1C1R4BB01# | | |
| | | | ±0.25pF | GJM0224C1C1R4CB01# | | |
| | | 1.5pF | ±0.05pF | GJM0224C1C1R5WB01# | | |
| | | | ±0.1pF | GJM0224C1C1R5BB01# | | |
| | | | ±0.25pF | GJM0224C1C1R5CB01# | | |
| | | 1.6pF | ±0.05pF | GJM0224C1C1R6WB01# | | |
| ±0.1pF | GJM0224C1C1R6BB01# | | | | | |
| ±0.25pF | GJM0224C1C1R6CB01# | | | | | |
| 1.7pF | ±0.05pF | GJM0224C1C1R7WB01# | | | | |
| | ±0.1pF | GJM0224C1C1R7BB01# | | | | |

| T max. | Rated Voltage | TC Code | Cap. | Tol. | Part Number | |
|---------|--------------------|--------------------|---------|--------------------|--------------------|--------------------|
| 0.22mm | 16Vdc | CK | 1.7pF | ±0.25pF | GJM0224C1C1R7CB01# | |
| | | | | ±0.05pF | GJM0224C1C1R8WB01# | |
| | | | | | ±0.1pF | GJM0224C1C1R8BB01# |
| | | | | | ±0.25pF | GJM0224C1C1R8CB01# |
| | | | | | 1.9pF | ±0.05pF |
| | | | ±0.1pF | GJM0224C1C1R9BB01# | | |
| | | | ±0.25pF | GJM0224C1C1R9CB01# | | |
| | | | 2.0pF | ±0.05pF | | GJM0224C1C2R0WB01# |
| | | | | ±0.1pF | | GJM0224C1C2R0BB01# |
| | | | | ±0.25pF | | GJM0224C1C2R0CB01# |
| | | | CJ | 2.1pF | ±0.05pF | GJM0223C1C2R1WB01# |
| | | | | | ±0.1pF | GJM0223C1C2R1BB01# |
| | | | | | ±0.25pF | GJM0223C1C2R1CB01# |
| | | | | 2.2pF | ±0.05pF | GJM0223C1C2R2WB01# |
| | | | | | ±0.1pF | GJM0223C1C2R2BB01# |
| | | | | | ±0.25pF | GJM0223C1C2R2CB01# |
| | | | | 2.3pF | ±0.05pF | GJM0223C1C2R3WB01# |
| | | | | | ±0.1pF | GJM0223C1C2R3BB01# |
| | | | | | ±0.25pF | GJM0223C1C2R3CB01# |
| | | | | 2.4pF | ±0.05pF | GJM0223C1C2R4WB01# |
| | | | | | ±0.1pF | GJM0223C1C2R4BB01# |
| | | | | | ±0.25pF | GJM0223C1C2R4CB01# |
| | | | | 2.5pF | ±0.05pF | GJM0223C1C2R5WB01# |
| | | | | | ±0.1pF | GJM0223C1C2R5BB01# |
| | | | | | ±0.25pF | GJM0223C1C2R5CB01# |
| | | 2.6pF | | ±0.05pF | GJM0223C1C2R6WB01# | |
| | | | | ±0.1pF | GJM0223C1C2R6BB01# | |
| | | | | ±0.25pF | GJM0223C1C2R6CB01# | |
| | | 2.7pF | | ±0.05pF | GJM0223C1C2R7WB01# | |
| | | | | ±0.1pF | GJM0223C1C2R7BB01# | |
| | | | | ±0.25pF | GJM0223C1C2R7CB01# | |
| | | 2.8pF | | ±0.05pF | GJM0223C1C2R8WB01# | |
| | | | | ±0.1pF | GJM0223C1C2R8BB01# | |
| | | | | ±0.25pF | GJM0223C1C2R8CB01# | |
| | | 2.9pF | | ±0.05pF | GJM0223C1C2R9WB01# | |
| | | | ±0.1pF | GJM0223C1C2R9BB01# | | |
| | | | ±0.25pF | GJM0223C1C2R9CB01# | | |
| | | 3.0pF | ±0.05pF | GJM0223C1C3R0WB01# | | |
| | | | ±0.1pF | GJM0223C1C3R0BB01# | | |
| | | | ±0.25pF | GJM0223C1C3R0CB01# | | |
| | | 3.1pF | ±0.05pF | GJM0223C1C3R1WB01# | | |
| | | | ±0.1pF | GJM0223C1C3R1BB01# | | |
| | | | ±0.25pF | GJM0223C1C3R1CB01# | | |
| | | 3.2pF | ±0.05pF | GJM0223C1C3R2WB01# | | |
| | | | ±0.1pF | GJM0223C1C3R2BB01# | | |
| | | | ±0.25pF | GJM0223C1C3R2CB01# | | |
| | | 3.3pF | ±0.05pF | GJM0223C1C3R3WB01# | | |
| | | | ±0.1pF | GJM0223C1C3R3BB01# | | |
| | | | ±0.25pF | GJM0223C1C3R3CB01# | | |
| | | 3.4pF | ±0.05pF | GJM0223C1C3R4WB01# | | |
| ±0.1pF | GJM0223C1C3R4BB01# | | | | | |
| ±0.25pF | GJM0223C1C3R4CB01# | | | | | |
| 3.5pF | ±0.05pF | GJM0223C1C3R5WB01# | | | | |
| | ±0.1pF | GJM0223C1C3R5BB01# | | | | |

Part number # indicates the package specification code.

For General Purpose GRM Series
 Capacitor Array GNM Series
 Low ESL LLD Series
 High-Q Type GMI Series
 High Frequency GQM Series
 Monolithic Microchip GMA Series
 For Bonding GMD Series
 Product Information

GJM Series Temperature Compensating Type HiQ Part Number List

(→ ■ 0.4x0.2mm)

| T max. | Rated Voltage | TC Code | Cap. | Tol. | Part Number | | |
|---------|--------------------|--------------------|-------|---------|--------------------|--------------------|--------------------|
| 0.22mm | 16Vdc | CJ | 3.5pF | ±0.25pF | GJM0223C1C3R5CB01# | | |
| | | | | ±0.05pF | GJM0223C1C3R6WB01# | | |
| | | | | ±0.1pF | GJM0223C1C3R6BB01# | | |
| | | | | ±0.25pF | GJM0223C1C3R6CB01# | | |
| | | | 3.7pF | ±0.05pF | GJM0223C1C3R7WB01# | | |
| | | | | ±0.1pF | GJM0223C1C3R7BB01# | | |
| | | | | ±0.25pF | GJM0223C1C3R7CB01# | | |
| | | | | 3.8pF | ±0.05pF | GJM0223C1C3R8WB01# | |
| | | | | | ±0.1pF | GJM0223C1C3R8BB01# | |
| | | | | | ±0.25pF | GJM0223C1C3R8CB01# | |
| | | | 3.9pF | ±0.05pF | GJM0223C1C3R9WB01# | | |
| | | | | ±0.1pF | GJM0223C1C3R9BB01# | | |
| | | | | ±0.25pF | GJM0223C1C3R9CB01# | | |
| | | | CH | 4.0pF | ±0.05pF | GJM0222C1C4R0WB01# | |
| | | | | | ±0.1pF | GJM0222C1C4R0BB01# | |
| | | | | | ±0.25pF | GJM0222C1C4R0CB01# | |
| | | | | | 4.1pF | ±0.05pF | GJM0222C1C4R1WB01# |
| | | | | | | ±0.1pF | GJM0222C1C4R1BB01# |
| | | | | | | ±0.25pF | GJM0222C1C4R1CB01# |
| | | | | | 4.2pF | ±0.05pF | GJM0222C1C4R2WB01# |
| | | | | | | ±0.1pF | GJM0222C1C4R2BB01# |
| | | | | | | ±0.25pF | GJM0222C1C4R2CB01# |
| | | | | | 4.3pF | ±0.05pF | GJM0222C1C4R3WB01# |
| | | | | | | ±0.1pF | GJM0222C1C4R3BB01# |
| | | ±0.25pF | | | | GJM0222C1C4R3CB01# | |
| | | 4.4pF | | | ±0.05pF | GJM0222C1C4R4WB01# | |
| | | | | | ±0.1pF | GJM0222C1C4R4BB01# | |
| | | | | | ±0.25pF | GJM0222C1C4R4CB01# | |
| | | 4.5pF | | | ±0.05pF | GJM0222C1C4R5WB01# | |
| | | | | | ±0.1pF | GJM0222C1C4R5BB01# | |
| | | | | | ±0.25pF | GJM0222C1C4R5CB01# | |
| | | 4.6pF | | | ±0.05pF | GJM0222C1C4R6WB01# | |
| | | | | | ±0.1pF | GJM0222C1C4R6BB01# | |
| | | | | | ±0.25pF | GJM0222C1C4R6CB01# | |
| | | 4.7pF | | | ±0.05pF | GJM0222C1C4R7WB01# | |
| | | | | | ±0.1pF | GJM0222C1C4R7BB01# | |
| | | | | | ±0.25pF | GJM0222C1C4R7CB01# | |
| | | 4.8pF | | ±0.05pF | GJM0222C1C4R8WB01# | | |
| | | | | ±0.1pF | GJM0222C1C4R8BB01# | | |
| | | | | ±0.25pF | GJM0222C1C4R8CB01# | | |
| | | 4.9pF | | ±0.05pF | GJM0222C1C4R9WB01# | | |
| | | | | ±0.1pF | GJM0222C1C4R9BB01# | | |
| | | | | ±0.25pF | GJM0222C1C4R9CB01# | | |
| | | 5.0pF | | ±0.05pF | GJM0222C1C5R0WB01# | | |
| | | | | ±0.1pF | GJM0222C1C5R0BB01# | | |
| | | | | ±0.25pF | GJM0222C1C5R0CB01# | | |
| | | 5.1pF | | ±0.05pF | GJM0222C1C5R1WB01# | | |
| | | | | ±0.1pF | GJM0222C1C5R1BB01# | | |
| ±0.25pF | GJM0222C1C5R1CB01# | | | | | | |
| ±0.5pF | GJM0222C1C5R1DB01# | | | | | | |
| 5.2pF | ±0.05pF | GJM0222C1C5R2WB01# | | | | | |
| | ±0.1pF | GJM0222C1C5R2BB01# | | | | | |
| | ±0.25pF | GJM0222C1C5R2CB01# | | | | | |
| | ±0.5pF | GJM0222C1C5R2DB01# | | | | | |

| T max. | Rated Voltage | TC Code | Cap. | Tol. | Part Number | |
|--------|---------------|---------|---------|---------|--------------------|--------------------|
| 0.22mm | 16Vdc | CH | 5.3pF | ±0.05pF | GJM0222C1C5R3WB01# | |
| | | | | ±0.1pF | GJM0222C1C5R3BB01# | |
| | | | | ±0.25pF | GJM0222C1C5R3CB01# | |
| | | | | ±0.5pF | GJM0222C1C5R3DB01# | |
| | | | 5.4pF | ±0.05pF | GJM0222C1C5R4WB01# | |
| | | | | ±0.1pF | GJM0222C1C5R4BB01# | |
| | | | | ±0.25pF | GJM0222C1C5R4CB01# | |
| | | | | ±0.5pF | GJM0222C1C5R4DB01# | |
| | | | | 5.5pF | ±0.05pF | GJM0222C1C5R5WB01# |
| | | | | | ±0.1pF | GJM0222C1C5R5BB01# |
| | | | ±0.25pF | | GJM0222C1C5R5CB01# | |
| | | | 5.6pF | ±0.05pF | GJM0222C1C5R6WB01# | |
| | | | | ±0.1pF | GJM0222C1C5R6BB01# | |
| | | | | ±0.25pF | GJM0222C1C5R6CB01# | |
| | | | 5.7pF | ±0.05pF | GJM0222C1C5R7WB01# | |
| | | | | ±0.1pF | GJM0222C1C5R7BB01# | |
| | | | | ±0.25pF | GJM0222C1C5R7CB01# | |
| | | | 5.8pF | ±0.05pF | GJM0222C1C5R8WB01# | |
| | | | | ±0.1pF | GJM0222C1C5R8BB01# | |
| | | | | ±0.25pF | GJM0222C1C5R8CB01# | |
| | | | 5.9pF | ±0.05pF | GJM0222C1C5R9WB01# | |
| | | | | ±0.1pF | GJM0222C1C5R9BB01# | |
| | | | | ±0.25pF | GJM0222C1C5R9CB01# | |
| | | | 6.0pF | ±0.05pF | GJM0222C1C6R0WB01# | |
| | | | | ±0.1pF | GJM0222C1C6R0BB01# | |
| | | | | ±0.25pF | GJM0222C1C6R0CB01# | |
| | | | 6.1pF | ±0.05pF | GJM0222C1C6R1WB01# | |
| | | | | ±0.1pF | GJM0222C1C6R1BB01# | |
| | | | | ±0.25pF | GJM0222C1C6R1CB01# | |
| | | | 6.2pF | ±0.05pF | GJM0222C1C6R2WB01# | |
| | | | | ±0.1pF | GJM0222C1C6R2BB01# | |
| | | | | ±0.25pF | GJM0222C1C6R2CB01# | |
| | | | 6.3pF | ±0.05pF | GJM0222C1C6R3WB01# | |
| | | | | ±0.1pF | GJM0222C1C6R3BB01# | |
| | | | | ±0.25pF | GJM0222C1C6R3CB01# | |
| | | | 6.4pF | ±0.05pF | GJM0222C1C6R4WB01# | |
| | | | | ±0.1pF | GJM0222C1C6R4BB01# | |
| | | | | ±0.25pF | GJM0222C1C6R4CB01# | |
| | | | 6.5pF | ±0.05pF | GJM0222C1C6R5WB01# | |
| | | | | ±0.1pF | GJM0222C1C6R5BB01# | |
| | | | | ±0.25pF | GJM0222C1C6R5CB01# | |
| | | | 6.6pF | ±0.05pF | GJM0222C1C6R6WB01# | |
| | | | | ±0.1pF | GJM0222C1C6R6BB01# | |

For General Purpose GRM Series
 Capacitor Array GNM Series
 Low ESL LLL Series
 High-Q Type GJM Series
 High Frequency GQM Series
 Monolithic Microchip GMA Series
 For Bonding GMD Series
 Product Information

Part number # indicates the package specification code.

GJM Series Temperature Compensating Type HiQ Part Number List

(→ ■ 0.4x0.2mm)

| T max. | Rated Voltage | TC Code | Cap. | Tol. | Part Number |
|--------|---------------|---------|-------|---------|---------------------------|
| 0.22mm | 16Vdc | CH | 6.6pF | ±0.25pF | GJM0222C1C6R6CB01# |
| | | | | ±0.5pF | GJM0222C1C6R6DB01# |
| | | | 6.7pF | ±0.05pF | GJM0222C1C6R7WB01# |
| | | | | ±0.1pF | GJM0222C1C6R7BB01# |
| | | | | ±0.25pF | GJM0222C1C6R7CB01# |
| | | | | ±0.5pF | GJM0222C1C6R7DB01# |
| | | | 6.8pF | ±0.05pF | GJM0222C1C6R8WB01# |
| | | | | ±0.1pF | GJM0222C1C6R8BB01# |
| | | | | ±0.25pF | GJM0222C1C6R8CB01# |
| | | | | ±0.5pF | GJM0222C1C6R8DB01# |
| | | | 6.9pF | ±0.05pF | GJM0222C1C6R9WB01# |
| | | | | ±0.1pF | GJM0222C1C6R9BB01# |
| | | | | ±0.25pF | GJM0222C1C6R9CB01# |
| | | | | ±0.5pF | GJM0222C1C6R9DB01# |
| | | | 7.0pF | ±0.05pF | GJM0222C1C7R0WB01# |
| | | | | ±0.1pF | GJM0222C1C7R0BB01# |
| | | | | ±0.25pF | GJM0222C1C7R0CB01# |
| | | | | ±0.5pF | GJM0222C1C7R0DB01# |
| | | | 7.1pF | ±0.05pF | GJM0222C1C7R1WB01# |
| | | | | ±0.1pF | GJM0222C1C7R1BB01# |
| | | | | ±0.25pF | GJM0222C1C7R1CB01# |
| | | | | ±0.5pF | GJM0222C1C7R1DB01# |
| | | | 7.2pF | ±0.05pF | GJM0222C1C7R2WB01# |
| | | | | ±0.1pF | GJM0222C1C7R2BB01# |
| | | | | ±0.25pF | GJM0222C1C7R2CB01# |
| | | | | ±0.5pF | GJM0222C1C7R2DB01# |
| | | | 7.3pF | ±0.05pF | GJM0222C1C7R3WB01# |
| | | | | ±0.1pF | GJM0222C1C7R3BB01# |
| | | | | ±0.25pF | GJM0222C1C7R3CB01# |
| | | | | ±0.5pF | GJM0222C1C7R3DB01# |
| | | | 7.4pF | ±0.05pF | GJM0222C1C7R4WB01# |
| | | | | ±0.1pF | GJM0222C1C7R4BB01# |
| | | | | ±0.25pF | GJM0222C1C7R4CB01# |
| | | | | ±0.5pF | GJM0222C1C7R4DB01# |
| | | | 7.5pF | ±0.05pF | GJM0222C1C7R5WB01# |
| | | | | ±0.1pF | GJM0222C1C7R5BB01# |
| | | | | ±0.25pF | GJM0222C1C7R5CB01# |
| | | | | ±0.5pF | GJM0222C1C7R5DB01# |
| | | | 7.6pF | ±0.05pF | GJM0222C1C7R6WB01# |
| | | | | ±0.1pF | GJM0222C1C7R6BB01# |
| | | | | ±0.25pF | GJM0222C1C7R6CB01# |
| | | | | ±0.5pF | GJM0222C1C7R6DB01# |
| | | | 7.7pF | ±0.05pF | GJM0222C1C7R7WB01# |
| | | | | ±0.1pF | GJM0222C1C7R7BB01# |
| | | | | ±0.25pF | GJM0222C1C7R7CB01# |
| | | | | ±0.5pF | GJM0222C1C7R7DB01# |
| | | | 7.8pF | ±0.05pF | GJM0222C1C7R8WB01# |
| | | | | ±0.1pF | GJM0222C1C7R8BB01# |
| | | | | ±0.25pF | GJM0222C1C7R8CB01# |
| | | | | ±0.5pF | GJM0222C1C7R8DB01# |
| | | | 7.9pF | ±0.05pF | GJM0222C1C7R9WB01# |
| | | | | ±0.1pF | GJM0222C1C7R9BB01# |
| | | | | ±0.25pF | GJM0222C1C7R9CB01# |
| | | | | ±0.5pF | GJM0222C1C7R9DB01# |

| T max. | Rated Voltage | TC Code | Cap. | Tol. | Part Number |
|--------|---------------|---------|-------|---------|---------------------------|
| 0.22mm | 16Vdc | CH | 8.0pF | ±0.05pF | GJM0222C1C8R0WB01# |
| | | | | ±0.1pF | GJM0222C1C8R0BB01# |
| | | | | ±0.25pF | GJM0222C1C8R0CB01# |
| | | | | ±0.5pF | GJM0222C1C8R0DB01# |
| | | | 8.1pF | ±0.05pF | GJM0222C1C8R1WB01# |
| | | | | ±0.1pF | GJM0222C1C8R1BB01# |
| | | | | ±0.25pF | GJM0222C1C8R1CB01# |
| | | | | ±0.5pF | GJM0222C1C8R1DB01# |
| | | | 8.2pF | ±0.05pF | GJM0222C1C8R2WB01# |
| | | | | ±0.1pF | GJM0222C1C8R2BB01# |
| | | | | ±0.25pF | GJM0222C1C8R2CB01# |
| | | | | ±0.5pF | GJM0222C1C8R2DB01# |
| | | | 8.3pF | ±0.05pF | GJM0222C1C8R3WB01# |
| | | | | ±0.1pF | GJM0222C1C8R3BB01# |
| | | | | ±0.25pF | GJM0222C1C8R3CB01# |
| | | | | ±0.5pF | GJM0222C1C8R3DB01# |
| | | | 8.4pF | ±0.05pF | GJM0222C1C8R4WB01# |
| | | | | ±0.1pF | GJM0222C1C8R4BB01# |
| | | | | ±0.25pF | GJM0222C1C8R4CB01# |
| | | | | ±0.5pF | GJM0222C1C8R4DB01# |
| | | | 8.5pF | ±0.05pF | GJM0222C1C8R5WB01# |
| | | | | ±0.1pF | GJM0222C1C8R5BB01# |
| | | | | ±0.25pF | GJM0222C1C8R5CB01# |
| | | | | ±0.5pF | GJM0222C1C8R5DB01# |
| | | | 8.6pF | ±0.05pF | GJM0222C1C8R6WB01# |
| | | | | ±0.1pF | GJM0222C1C8R6BB01# |
| | | | | ±0.25pF | GJM0222C1C8R6CB01# |
| | | | | ±0.5pF | GJM0222C1C8R6DB01# |
| | | | 8.7pF | ±0.05pF | GJM0222C1C8R7WB01# |
| | | | | ±0.1pF | GJM0222C1C8R7BB01# |
| | | | | ±0.25pF | GJM0222C1C8R7CB01# |
| | | | | ±0.5pF | GJM0222C1C8R7DB01# |
| | | | 8.8pF | ±0.05pF | GJM0222C1C8R8WB01# |
| | | | | ±0.1pF | GJM0222C1C8R8BB01# |
| | | | | ±0.25pF | GJM0222C1C8R8CB01# |
| | | | | ±0.5pF | GJM0222C1C8R8DB01# |
| | | | 8.9pF | ±0.05pF | GJM0222C1C8R9WB01# |
| | | | | ±0.1pF | GJM0222C1C8R9BB01# |
| | | | | ±0.25pF | GJM0222C1C8R9CB01# |
| | | | | ±0.5pF | GJM0222C1C8R9DB01# |
| | | | 9.0pF | ±0.05pF | GJM0222C1C9R0WB01# |
| | | | | ±0.1pF | GJM0222C1C9R0BB01# |
| | | | | ±0.25pF | GJM0222C1C9R0CB01# |
| | | | | ±0.5pF | GJM0222C1C9R0DB01# |
| | | | 9.1pF | ±0.05pF | GJM0222C1C9R1WB01# |
| | | | | ±0.1pF | GJM0222C1C9R1BB01# |
| | | | | ±0.25pF | GJM0222C1C9R1CB01# |
| | | | | ±0.5pF | GJM0222C1C9R1DB01# |
| | | | 9.2pF | ±0.05pF | GJM0222C1C9R2WB01# |
| | | | | ±0.1pF | GJM0222C1C9R2BB01# |
| | | | | ±0.25pF | GJM0222C1C9R2CB01# |
| | | | | ±0.5pF | GJM0222C1C9R2DB01# |
| | | | 9.3pF | ±0.05pF | GJM0222C1C9R3WB01# |
| | | | | ±0.1pF | GJM0222C1C9R3BB01# |

Part number # indicates the package specification code.

For General Purpose GRM Series
 Capacitor Array GNM Series
 Low ESL LLI Series
 High-Q Type GMI Series
 High Frequency GQM Series
 Monolithic Microchip GMA Series
 For Bonding GMD Series
 Product Information

GJM Series Temperature Compensating Type HiQ Part Number List

(→ ■ 0.4x0.2mm)

| T max. | Rated Voltage | TC Code | Cap. | Tol. | Part Number |
|--------|---------------|---------|-------|---------|--------------------|
| 0.22mm | 16Vdc | CH | 9.3pF | ±0.25pF | GJM0222C1C9R3CB01# |
| | | | | ±0.5pF | GJM0222C1C9R3DB01# |
| | | | 9.4pF | ±0.05pF | GJM0222C1C9R4WB01# |
| | | | | ±0.1pF | GJM0222C1C9R4BB01# |
| | | | | ±0.25pF | GJM0222C1C9R4CB01# |
| | | | | ±0.5pF | GJM0222C1C9R4DB01# |
| | | | 9.5pF | ±0.05pF | GJM0222C1C9R5WB01# |
| | | | | ±0.1pF | GJM0222C1C9R5BB01# |
| | | | | ±0.25pF | GJM0222C1C9R5CB01# |
| | | | | ±0.5pF | GJM0222C1C9R5DB01# |
| | | | 9.6pF | ±0.05pF | GJM0222C1C9R6WB01# |
| | | | | ±0.1pF | GJM0222C1C9R6BB01# |
| | | | | ±0.25pF | GJM0222C1C9R6CB01# |
| | | | | ±0.5pF | GJM0222C1C9R6DB01# |
| | | | 9.7pF | ±0.05pF | GJM0222C1C9R7WB01# |
| | | | | ±0.1pF | GJM0222C1C9R7BB01# |
| | | | | ±0.25pF | GJM0222C1C9R7CB01# |
| | | | | ±0.5pF | GJM0222C1C9R7DB01# |
| | | | 9.8pF | ±0.05pF | GJM0222C1C9R8WB01# |
| | | | | ±0.1pF | GJM0222C1C9R8BB01# |
| | | | | ±0.25pF | GJM0222C1C9R8CB01# |
| | | | | ±0.5pF | GJM0222C1C9R8DB01# |
| | | | 9.9pF | ±0.05pF | GJM0222C1C9R9WB01# |
| | | | | ±0.1pF | GJM0222C1C9R9BB01# |
| | | | | ±0.25pF | GJM0222C1C9R9CB01# |
| | | | | ±0.5pF | GJM0222C1C9R9DB01# |
| | | | 10pF | ±2% | GJM0222C1C100GB01# |
| | | | | ±5% | GJM0222C1C100JB01# |

| T max. | Rated Voltage | TC Code | Cap. | Tol. | Part Number |
|--------|---------------|---------|-------|---------|--------------------|
| 0.33mm | 25Vdc | C0G | 1.1pF | ±0.25pF | GJM0335C1E1R1CB01# |
| | | | | ±0.05pF | GJM0335C1E1R2WB01# |
| | | | 1.2pF | ±0.1pF | GJM0335C1E1R2BB01# |
| | | | | ±0.25pF | GJM0335C1E1R2CB01# |
| | | | | ±0.05pF | GJM0335C1E1R3WB01# |
| | | | 1.3pF | ±0.1pF | GJM0335C1E1R3BB01# |
| | | | | ±0.25pF | GJM0335C1E1R3CB01# |
| | | | | ±0.05pF | GJM0335C1E1R4WB01# |
| | | | 1.4pF | ±0.1pF | GJM0335C1E1R4BB01# |
| | | | | ±0.25pF | GJM0335C1E1R4CB01# |
| | | | | ±0.05pF | GJM0335C1E1R5WB01# |
| | | | 1.5pF | ±0.1pF | GJM0335C1E1R5BB01# |
| | | | | ±0.25pF | GJM0335C1E1R5CB01# |
| | | | | ±0.05pF | GJM0335C1E1R6WB01# |
| | | | 1.6pF | ±0.1pF | GJM0335C1E1R6BB01# |
| | | | | ±0.25pF | GJM0335C1E1R6CB01# |
| | | | | ±0.05pF | GJM0335C1E1R7WB01# |
| | | | 1.7pF | ±0.1pF | GJM0335C1E1R7BB01# |
| | | | | ±0.25pF | GJM0335C1E1R7CB01# |
| | | | | ±0.05pF | GJM0335C1E1R8WB01# |
| | | | 1.8pF | ±0.1pF | GJM0335C1E1R8BB01# |
| | | | | ±0.25pF | GJM0335C1E1R8CB01# |
| | | | | ±0.05pF | GJM0335C1E1R9WB01# |
| | | | 1.9pF | ±0.1pF | GJM0335C1E1R9BB01# |
| | | | | ±0.25pF | GJM0335C1E1R9CB01# |
| | | | | ±0.05pF | GJM0335C1E2R0WB01# |
| | | | 2.0pF | ±0.1pF | GJM0335C1E2R0BB01# |
| | | | | ±0.25pF | GJM0335C1E2R0CB01# |
| | | | | ±0.05pF | GJM0335C1E2R1WB01# |
| | | | 2.1pF | ±0.1pF | GJM0335C1E2R1BB01# |
| | | | | ±0.25pF | GJM0335C1E2R1CB01# |
| | | | | ±0.05pF | GJM0335C1E2R2WB01# |
| | | | 2.2pF | ±0.1pF | GJM0335C1E2R2BB01# |
| | | | | ±0.25pF | GJM0335C1E2R2CB01# |
| | | | | ±0.05pF | GJM0335C1E2R3WB01# |
| | | | 2.3pF | ±0.1pF | GJM0335C1E2R3BB01# |
| | | | | ±0.25pF | GJM0335C1E2R3CB01# |
| | | | | ±0.05pF | GJM0335C1E2R4WB01# |
| | | | 2.4pF | ±0.1pF | GJM0335C1E2R4BB01# |
| | | | | ±0.25pF | GJM0335C1E2R4CB01# |
| | | | | ±0.05pF | GJM0335C1E2R5WB01# |
| | | | 2.5pF | ±0.1pF | GJM0335C1E2R5BB01# |
| | | | | ±0.25pF | GJM0335C1E2R5CB01# |
| | | | | ±0.05pF | GJM0335C1E2R6WB01# |
| | | | 2.6pF | ±0.1pF | GJM0335C1E2R6BB01# |
| | | | | ±0.25pF | GJM0335C1E2R6CB01# |
| | | | | ±0.05pF | GJM0335C1E2R7WB01# |
| | | | 2.7pF | ±0.1pF | GJM0335C1E2R7BB01# |
| | | | | ±0.25pF | GJM0335C1E2R7CB01# |
| | | | | ±0.05pF | GJM0335C1E2R8WB01# |
| | | | 2.8pF | ±0.1pF | GJM0335C1E2R8BB01# |
| | | | | ±0.25pF | GJM0335C1E2R8CB01# |
| | | | | ±0.05pF | GJM0335C1E2R9WB01# |
| | | | 2.9pF | ±0.1pF | GJM0335C1E2R9BB01# |

■ 0.6x0.3mm Ultra-compact

| T max. | Rated Voltage | TC Code | Cap. | Tol. | Part Number |
|--------|---------------|---------|-------|---------|--------------------|
| 0.33mm | 25Vdc | C0G | 0.2pF | ±0.05pF | GJM0335C1ER20WB01# |
| | | | | ±0.1pF | GJM0335C1ER20BB01# |
| | | | 0.3pF | ±0.05pF | GJM0335C1ER30WB01# |
| | | | | ±0.1pF | GJM0335C1ER30BB01# |
| | | | 0.4pF | ±0.05pF | GJM0335C1ER40WB01# |
| | | | | ±0.1pF | GJM0335C1ER40BB01# |
| | | | 0.5pF | ±0.05pF | GJM0335C1ER50WB01# |
| | | | | ±0.1pF | GJM0335C1ER50BB01# |
| | | | 0.6pF | ±0.05pF | GJM0335C1ER60WB01# |
| | | | | ±0.1pF | GJM0335C1ER60BB01# |
| | | | 0.7pF | ±0.05pF | GJM0335C1ER70WB01# |
| | | | | ±0.1pF | GJM0335C1ER70BB01# |
| | | | 0.8pF | ±0.05pF | GJM0335C1ER80WB01# |
| | | | | ±0.1pF | GJM0335C1ER80BB01# |
| | | | 0.9pF | ±0.05pF | GJM0335C1ER90WB01# |
| | | | | ±0.1pF | GJM0335C1ER90BB01# |
| | | | 1.0pF | ±0.05pF | GJM0335C1E1R0WB01# |
| | | | | ±0.1pF | GJM0335C1E1R0BB01# |
| | | | | ±0.25pF | GJM0335C1E1R0CB01# |
| | | | 1.1pF | ±0.05pF | GJM0335C1E1R1WB01# |
| | | | | ±0.1pF | GJM0335C1E1R1BB01# |

For General Purpose GRM Series
 Capacitor Array GNM Series
 Low ESL LLL Series
 High-Q Type GJM Series
 High Frequency GQM Series
 Monolithic Microchip GMA Series
 For Bonding GMD Series
 Product Information

Part number # indicates the package specification code.

GJM Series Temperature Compensating Type HiQ Part Number List

(→ ■ 0.6x0.3mm)

| T max. | Rated Voltage | TC Code | Cap. | Tol. | Part Number |
|--------|---------------|---------|---------|---------|---------------------------|
| 0.33mm | 25Vdc | C0G | 2.9pF | ±0.25pF | GJM0335C1E2R9CB01# |
| | | | | ±0.05pF | GJM0335C1E3R0WB01# |
| | | | | | ±0.1pF |
| | | | ±0.25pF | | GJM0335C1E3R0CB01# |
| | | | 3.1pF | ±0.05pF | GJM0335C1E3R1WB01# |
| | | | | ±0.1pF | GJM0335C1E3R1BB01# |
| | | | | ±0.25pF | GJM0335C1E3R1CB01# |
| | | | 3.2pF | ±0.05pF | GJM0335C1E3R2WB01# |
| | | | | ±0.1pF | GJM0335C1E3R2BB01# |
| | | | | ±0.25pF | GJM0335C1E3R2CB01# |
| | | | 3.3pF | ±0.05pF | GJM0335C1E3R3WB01# |
| | | | | ±0.1pF | GJM0335C1E3R3BB01# |
| | | | | ±0.25pF | GJM0335C1E3R3CB01# |
| | | | 3.4pF | ±0.05pF | GJM0335C1E3R4WB01# |
| | | | | ±0.1pF | GJM0335C1E3R4BB01# |
| | | | | ±0.25pF | GJM0335C1E3R4CB01# |
| | | | 3.5pF | ±0.05pF | GJM0335C1E3R5WB01# |
| | | | | ±0.1pF | GJM0335C1E3R5BB01# |
| | | | | ±0.25pF | GJM0335C1E3R5CB01# |
| | | | 3.6pF | ±0.05pF | GJM0335C1E3R6WB01# |
| | | | | ±0.1pF | GJM0335C1E3R6BB01# |
| | | | | ±0.25pF | GJM0335C1E3R6CB01# |
| | | | 3.7pF | ±0.05pF | GJM0335C1E3R7WB01# |
| | | | | ±0.1pF | GJM0335C1E3R7BB01# |
| | | | | ±0.25pF | GJM0335C1E3R7CB01# |
| | | | 3.8pF | ±0.05pF | GJM0335C1E3R8WB01# |
| | | | | ±0.1pF | GJM0335C1E3R8BB01# |
| | | | | ±0.25pF | GJM0335C1E3R8CB01# |
| | | | 3.9pF | ±0.05pF | GJM0335C1E3R9WB01# |
| | | | | ±0.1pF | GJM0335C1E3R9BB01# |
| | | | | ±0.25pF | GJM0335C1E3R9CB01# |
| | | | 4.0pF | ±0.05pF | GJM0335C1E4R0WB01# |
| | | | | ±0.1pF | GJM0335C1E4R0BB01# |
| | | | | ±0.25pF | GJM0335C1E4R0CB01# |
| | | | 4.1pF | ±0.05pF | GJM0335C1E4R1WB01# |
| | | | | ±0.1pF | GJM0335C1E4R1BB01# |
| | | | | ±0.25pF | GJM0335C1E4R1CB01# |
| | | | 4.2pF | ±0.05pF | GJM0335C1E4R2WB01# |
| | | | | ±0.1pF | GJM0335C1E4R2BB01# |
| | | | | ±0.25pF | GJM0335C1E4R2CB01# |
| | | | 4.3pF | ±0.05pF | GJM0335C1E4R3WB01# |
| | | | | ±0.1pF | GJM0335C1E4R3BB01# |
| | | | | ±0.25pF | GJM0335C1E4R3CB01# |
| | | | 4.4pF | ±0.05pF | GJM0335C1E4R4WB01# |
| | | | | ±0.1pF | GJM0335C1E4R4BB01# |
| | | | | ±0.25pF | GJM0335C1E4R4CB01# |
| | | | 4.5pF | ±0.05pF | GJM0335C1E4R5WB01# |
| | | | | ±0.1pF | GJM0335C1E4R5BB01# |
| | | | | ±0.25pF | GJM0335C1E4R5CB01# |
| | | | 4.6pF | ±0.05pF | GJM0335C1E4R6WB01# |
| | | | | ±0.1pF | GJM0335C1E4R6BB01# |
| | | | | ±0.25pF | GJM0335C1E4R6CB01# |
| | | | 4.7pF | ±0.05pF | GJM0335C1E4R7WB01# |
| | | | | ±0.1pF | GJM0335C1E4R7BB01# |

| T max. | Rated Voltage | TC Code | Cap. | Tol. | Part Number |
|--------|---------------|---------|---------|---------|---------------------------|
| 0.33mm | 25Vdc | C0G | 4.7pF | ±0.25pF | GJM0335C1E4R7CB01# |
| | | | | ±0.05pF | GJM0335C1E4R8WB01# |
| | | | | | ±0.1pF |
| | | | ±0.25pF | | GJM0335C1E4R8CB01# |
| | | | 4.9pF | ±0.05pF | GJM0335C1E4R9WB01# |
| | | | | ±0.1pF | GJM0335C1E4R9BB01# |
| | | | | ±0.25pF | GJM0335C1E4R9CB01# |
| | | | 5.0pF | ±0.05pF | GJM0335C1E5R0WB01# |
| | | | | ±0.1pF | GJM0335C1E5R0BB01# |
| | | | | ±0.25pF | GJM0335C1E5R0CB01# |
| | | | 5.1pF | ±0.05pF | GJM0335C1E5R1WB01# |
| | | | | ±0.1pF | GJM0335C1E5R1BB01# |
| | | | | ±0.25pF | GJM0335C1E5R1CB01# |
| | | | 5.2pF | ±0.05pF | GJM0335C1E5R2WB01# |
| | | | | ±0.1pF | GJM0335C1E5R2BB01# |
| | | | | ±0.25pF | GJM0335C1E5R2CB01# |
| | | | 5.3pF | ±0.05pF | GJM0335C1E5R3WB01# |
| | | | | ±0.1pF | GJM0335C1E5R3BB01# |
| | | | | ±0.25pF | GJM0335C1E5R3CB01# |
| | | | 5.4pF | ±0.05pF | GJM0335C1E5R4WB01# |
| | | | | ±0.1pF | GJM0335C1E5R4BB01# |
| | | | | ±0.25pF | GJM0335C1E5R4CB01# |
| | | | 5.5pF | ±0.05pF | GJM0335C1E5R5WB01# |
| | | | | ±0.1pF | GJM0335C1E5R5BB01# |
| | | | | ±0.25pF | GJM0335C1E5R5CB01# |
| | | | 5.6pF | ±0.05pF | GJM0335C1E5R6WB01# |
| | | | | ±0.1pF | GJM0335C1E5R6BB01# |
| | | | | ±0.25pF | GJM0335C1E5R6CB01# |
| | | | 5.7pF | ±0.05pF | GJM0335C1E5R7WB01# |
| | | | | ±0.1pF | GJM0335C1E5R7BB01# |
| | | | | ±0.25pF | GJM0335C1E5R7CB01# |
| | | | 5.8pF | ±0.05pF | GJM0335C1E5R8WB01# |
| | | | | ±0.1pF | GJM0335C1E5R8BB01# |
| | | | | ±0.25pF | GJM0335C1E5R8CB01# |
| | | | 5.9pF | ±0.05pF | GJM0335C1E5R9WB01# |
| | | | | ±0.1pF | GJM0335C1E5R9BB01# |
| | | | | ±0.25pF | GJM0335C1E5R9CB01# |
| | | | 6.0pF | ±0.05pF | GJM0335C1E6R0WB01# |
| | | | | ±0.1pF | GJM0335C1E6R0BB01# |
| | | | | ±0.25pF | GJM0335C1E6R0CB01# |
| | | | 6.1pF | ±0.05pF | GJM0335C1E6R1WB01# |
| | | | | ±0.1pF | GJM0335C1E6R1BB01# |
| | | | | ±0.25pF | GJM0335C1E6R1CB01# |

Part number # indicates the package specification code.

For General Purpose GRM Series
 Capacitor Array GNM Series
 Low ESL LLQ Series
 High-Q Type GJM Series
 High Frequency GQM Series
 Monolithic Microchip GMA Series
 For Bonding GMD Series
 Product Information

GJM Series Temperature Compensating Type HiQ Part Number List

(→ ■ 0.6x0.3mm)

| T max. | Rated Voltage | TC Code | Cap. | Tol. | Part Number |
|--------|---------------|---------------------------|---------------------------|---------------------------|---------------------------|
| 0.33mm | 25Vdc | C0G | 6.2pF | ±0.05pF | GJM0335C1E6R2WB01# |
| | | | | ±0.1pF | GJM0335C1E6R2BB01# |
| | | | | ±0.25pF | GJM0335C1E6R2CB01# |
| | | | | ±0.5pF | GJM0335C1E6R2DB01# |
| | | | 6.3pF | ±0.05pF | GJM0335C1E6R3WB01# |
| | | | | ±0.1pF | GJM0335C1E6R3BB01# |
| | | | | ±0.25pF | GJM0335C1E6R3CB01# |
| | | | | ±0.5pF | GJM0335C1E6R3DB01# |
| | | | 6.4pF | ±0.05pF | GJM0335C1E6R4WB01# |
| | | | | ±0.1pF | GJM0335C1E6R4BB01# |
| | | | | ±0.25pF | GJM0335C1E6R4CB01# |
| | | | | ±0.5pF | GJM0335C1E6R4DB01# |
| | | | 6.5pF | ±0.05pF | GJM0335C1E6R5WB01# |
| | | | | ±0.1pF | GJM0335C1E6R5BB01# |
| | | | | ±0.25pF | GJM0335C1E6R5CB01# |
| | | | | ±0.5pF | GJM0335C1E6R5DB01# |
| | | | 6.6pF | ±0.05pF | GJM0335C1E6R6WB01# |
| | | | | ±0.1pF | GJM0335C1E6R6BB01# |
| | | | | ±0.25pF | GJM0335C1E6R6CB01# |
| | | | | ±0.5pF | GJM0335C1E6R6DB01# |
| | | | 6.7pF | ±0.05pF | GJM0335C1E6R7WB01# |
| | | | | ±0.1pF | GJM0335C1E6R7BB01# |
| | | | | ±0.25pF | GJM0335C1E6R7CB01# |
| | | | | ±0.5pF | GJM0335C1E6R7DB01# |
| | | 6.8pF | ±0.05pF | GJM0335C1E6R8WB01# | |
| | | | ±0.1pF | GJM0335C1E6R8BB01# | |
| | | | ±0.25pF | GJM0335C1E6R8CB01# | |
| | | | ±0.5pF | GJM0335C1E6R8DB01# | |
| | | C0H | 6.9pF | ±0.05pF | GJM0336C1E6R9WB01# |
| | | | | ±0.1pF | GJM0336C1E6R9BB01# |
| | | | | ±0.25pF | GJM0336C1E6R9CB01# |
| | | | | ±0.5pF | GJM0336C1E6R9DB01# |
| | | | 7.0pF | ±0.05pF | GJM0336C1E7R0WB01# |
| | | | | ±0.1pF | GJM0336C1E7R0BB01# |
| | | | | ±0.25pF | GJM0336C1E7R0CB01# |
| | | | | ±0.5pF | GJM0336C1E7R0DB01# |
| | | | 7.1pF | ±0.05pF | GJM0336C1E7R1WB01# |
| | | | | ±0.1pF | GJM0336C1E7R1BB01# |
| | | | | ±0.25pF | GJM0336C1E7R1CB01# |
| | | | | ±0.5pF | GJM0336C1E7R1DB01# |
| | | | 7.2pF | ±0.05pF | GJM0336C1E7R2WB01# |
| | | | | ±0.1pF | GJM0336C1E7R2BB01# |
| | | | | ±0.25pF | GJM0336C1E7R2CB01# |
| | | | | ±0.5pF | GJM0336C1E7R2DB01# |
| | | | 7.3pF | ±0.05pF | GJM0336C1E7R3WB01# |
| | | | | ±0.1pF | GJM0336C1E7R3BB01# |
| | | | | ±0.25pF | GJM0336C1E7R3CB01# |
| | | | | ±0.5pF | GJM0336C1E7R3DB01# |
| 7.4pF | ±0.05pF | | GJM0336C1E7R4WB01# | | |
| | ±0.1pF | | GJM0336C1E7R4BB01# | | |
| | ±0.25pF | | GJM0336C1E7R4CB01# | | |
| | ±0.5pF | | GJM0336C1E7R4DB01# | | |
| 7.5pF | ±0.05pF | GJM0336C1E7R5WB01# | | | |
| | ±0.1pF | GJM0336C1E7R5BB01# | | | |

| T max. | Rated Voltage | TC Code | Cap. | Tol. | Part Number |
|--------|---------------|---------|---------|---------------------------|---------------------------|
| 0.33mm | 25Vdc | C0H | 7.5pF | ±0.25pF | GJM0336C1E7R5CB01# |
| | | | | ±0.5pF | GJM0336C1E7R5DB01# |
| | | | 7.6pF | ±0.05pF | GJM0336C1E7R6WB01# |
| | | | | ±0.1pF | GJM0336C1E7R6BB01# |
| | | | | ±0.25pF | GJM0336C1E7R6CB01# |
| | | | 7.7pF | ±0.05pF | GJM0336C1E7R7WB01# |
| | | | | ±0.1pF | GJM0336C1E7R7BB01# |
| | | | | ±0.25pF | GJM0336C1E7R7CB01# |
| | | | 7.8pF | ±0.05pF | GJM0336C1E7R8WB01# |
| | | | | ±0.1pF | GJM0336C1E7R8BB01# |
| | | | | ±0.25pF | GJM0336C1E7R8CB01# |
| | | | 7.9pF | ±0.05pF | GJM0336C1E7R9WB01# |
| | | | | ±0.1pF | GJM0336C1E7R9BB01# |
| | | | | ±0.25pF | GJM0336C1E7R9CB01# |
| | | | 8.0pF | ±0.05pF | GJM0336C1E8R0WB01# |
| | | | | ±0.1pF | GJM0336C1E8R0BB01# |
| | | | | ±0.25pF | GJM0336C1E8R0CB01# |
| | | | 8.1pF | ±0.05pF | GJM0336C1E8R1WB01# |
| | | | | ±0.1pF | GJM0336C1E8R1BB01# |
| | | | | ±0.25pF | GJM0336C1E8R1CB01# |
| | | | 8.2pF | ±0.05pF | GJM0336C1E8R2WB01# |
| | | | | ±0.1pF | GJM0336C1E8R2BB01# |
| | | | | ±0.25pF | GJM0336C1E8R2CB01# |
| | | | 8.3pF | ±0.05pF | GJM0336C1E8R3WB01# |
| | | ±0.1pF | | GJM0336C1E8R3BB01# | |
| | | ±0.25pF | | GJM0336C1E8R3CB01# | |
| | | 8.4pF | ±0.05pF | GJM0336C1E8R4WB01# | |
| | | | ±0.1pF | GJM0336C1E8R4BB01# | |
| | | | ±0.25pF | GJM0336C1E8R4CB01# | |
| | | 8.5pF | ±0.05pF | GJM0336C1E8R5WB01# | |
| | | | ±0.1pF | GJM0336C1E8R5BB01# | |
| | | | ±0.25pF | GJM0336C1E8R5CB01# | |
| | | 8.6pF | ±0.05pF | GJM0336C1E8R6WB01# | |
| | | | ±0.1pF | GJM0336C1E8R6BB01# | |
| | | | ±0.25pF | GJM0336C1E8R6CB01# | |
| | | 8.7pF | ±0.05pF | GJM0336C1E8R7WB01# | |
| | | | ±0.1pF | GJM0336C1E8R7BB01# | |
| | | | ±0.25pF | GJM0336C1E8R7CB01# | |
| | | 8.8pF | ±0.05pF | GJM0336C1E8R8WB01# | |
| | | | ±0.1pF | GJM0336C1E8R8BB01# | |
| | | | ±0.25pF | GJM0336C1E8R8CB01# | |

Part number # indicates the package specification code.

GJM Series Temperature Compensating Type HiQ Part Number List

(→ ■ 0.6x0.3mm)

| T max. | Rated Voltage | TC Code | Cap. | Tol. | Part Number |
|--------|---------------|---------|-------|---------|---------------------------|
| 0.33mm | 25Vdc | C0H | 8.9pF | ±0.05pF | GJM0336C1E8R9WB01# |
| | | | | ±0.1pF | GJM0336C1E8R9BB01# |
| | | | | ±0.25pF | GJM0336C1E8R9CB01# |
| | | | | ±0.5pF | GJM0336C1E8R9DB01# |
| | | | 9.0pF | ±0.05pF | GJM0336C1E9R0WB01# |
| | | | | ±0.1pF | GJM0336C1E9R0BB01# |
| | | | | ±0.25pF | GJM0336C1E9R0CB01# |
| | | | | ±0.5pF | GJM0336C1E9R0DB01# |
| | | | 9.1pF | ±0.05pF | GJM0336C1E9R1WB01# |
| | | | | ±0.1pF | GJM0336C1E9R1BB01# |
| | | | | ±0.25pF | GJM0336C1E9R1CB01# |
| | | | | ±0.5pF | GJM0336C1E9R1DB01# |
| | | | 9.2pF | ±0.05pF | GJM0336C1E9R2WB01# |
| | | | | ±0.1pF | GJM0336C1E9R2BB01# |
| | | | | ±0.25pF | GJM0336C1E9R2CB01# |
| | | | | ±0.5pF | GJM0336C1E9R2DB01# |
| | | | 9.3pF | ±0.05pF | GJM0336C1E9R3WB01# |
| | | | | ±0.1pF | GJM0336C1E9R3BB01# |
| | | | | ±0.25pF | GJM0336C1E9R3CB01# |
| | | | | ±0.5pF | GJM0336C1E9R3DB01# |
| | | | 9.4pF | ±0.05pF | GJM0336C1E9R4WB01# |
| | | | | ±0.1pF | GJM0336C1E9R4BB01# |
| | | | | ±0.25pF | GJM0336C1E9R4CB01# |
| | | | | ±0.5pF | GJM0336C1E9R4DB01# |
| | | | 9.5pF | ±0.05pF | GJM0336C1E9R5WB01# |
| | | | | ±0.1pF | GJM0336C1E9R5BB01# |
| | | | | ±0.25pF | GJM0336C1E9R5CB01# |
| | | | | ±0.5pF | GJM0336C1E9R5DB01# |
| | | | 9.6pF | ±0.05pF | GJM0336C1E9R6WB01# |
| | | | | ±0.1pF | GJM0336C1E9R6BB01# |
| | | | | ±0.25pF | GJM0336C1E9R6CB01# |
| | | | | ±0.5pF | GJM0336C1E9R6DB01# |
| | | | 9.7pF | ±0.05pF | GJM0336C1E9R7WB01# |
| | | | | ±0.1pF | GJM0336C1E9R7BB01# |
| | | | | ±0.25pF | GJM0336C1E9R7CB01# |
| | | | | ±0.5pF | GJM0336C1E9R7DB01# |
| | | | 9.8pF | ±0.05pF | GJM0336C1E9R8WB01# |
| | | | | ±0.1pF | GJM0336C1E9R8BB01# |
| | | | | ±0.25pF | GJM0336C1E9R8CB01# |
| | | | | ±0.5pF | GJM0336C1E9R8DB01# |
| | | | 9.9pF | ±0.05pF | GJM0336C1E9R9WB01# |
| | | | | ±0.1pF | GJM0336C1E9R9BB01# |
| | | | | ±0.25pF | GJM0336C1E9R9CB01# |
| | | | | ±0.5pF | GJM0336C1E9R9DB01# |
| | | | 10pF | ±2% | GJM0336C1E100GB01# |
| | | | | ±5% | GJM0336C1E100JB01# |
| | | | 11pF | ±2% | GJM0336C1E110GB01# |
| | | | | ±5% | GJM0336C1E110JB01# |
| | | | 12pF | ±2% | GJM0336C1E120GB01# |
| | | | | ±5% | GJM0336C1E120JB01# |
| | | | 13pF | ±2% | GJM0336C1E130GB01# |
| | | | | ±5% | GJM0336C1E130JB01# |
| | | | 15pF | ±2% | GJM0336C1E150GB01# |
| | | | | ±5% | GJM0336C1E150JB01# |

| T max. | Rated Voltage | TC Code | Cap. | Tol. | Part Number | |
|---------|---------------------------|---------------------------|---------|---------------------------|---------------------------|---------------------------|
| 0.33mm | 25Vdc | C0H | 16pF | ±2% | GJM0336C1E160GB01# | |
| | | | | ±5% | GJM0336C1E160JB01# | |
| | | | 18pF | ±2% | GJM0336C1E180GB01# | |
| | | | | ±5% | GJM0336C1E180JB01# | |
| | | | 20pF | ±2% | GJM0336C1E200GB01# | |
| | | | | ±5% | GJM0336C1E200JB01# | |
| | | | CK | 0.2pF | ±0.05pF | GJM0334C1ER20WB01# |
| | | | | | ±0.1pF | GJM0334C1ER20BB01# |
| | | | | 0.3pF | ±0.05pF | GJM0334C1ER30WB01# |
| | | | | | ±0.1pF | GJM0334C1ER30BB01# |
| | | | | 0.4pF | ±0.05pF | GJM0334C1ER40WB01# |
| | | | | | ±0.1pF | GJM0334C1ER40BB01# |
| | | | | 0.5pF | ±0.05pF | GJM0334C1ER50WB01# |
| | | | | | ±0.1pF | GJM0334C1ER50BB01# |
| | | | | 0.6pF | ±0.05pF | GJM0334C1ER60WB01# |
| | | | | | ±0.1pF | GJM0334C1ER60BB01# |
| | | | | 0.7pF | ±0.05pF | GJM0334C1ER70WB01# |
| | | | | | ±0.1pF | GJM0334C1ER70BB01# |
| | | | | 0.8pF | ±0.05pF | GJM0334C1ER80WB01# |
| | | | | | ±0.1pF | GJM0334C1ER80BB01# |
| | | | | 0.9pF | ±0.05pF | GJM0334C1ER90WB01# |
| | | ±0.1pF | | | GJM0334C1ER90BB01# | |
| | | 1.0pF | | ±0.05pF | GJM0334C1E1R0WB01# | |
| | | | | ±0.1pF | GJM0334C1E1R0BB01# | |
| | | | | ±0.25pF | GJM0334C1E1R0CB01# | |
| | | 1.1pF | | ±0.05pF | GJM0334C1E1R1WB01# | |
| | | | | ±0.1pF | GJM0334C1E1R1BB01# | |
| | | | ±0.25pF | GJM0334C1E1R1CB01# | | |
| | | 1.2pF | ±0.05pF | GJM0334C1E1R2WB01# | | |
| | | | ±0.1pF | GJM0334C1E1R2BB01# | | |
| | | | ±0.25pF | GJM0334C1E1R2CB01# | | |
| | | 1.3pF | ±0.05pF | GJM0334C1E1R3WB01# | | |
| | | | ±0.1pF | GJM0334C1E1R3BB01# | | |
| | | | ±0.25pF | GJM0334C1E1R3CB01# | | |
| | | 1.4pF | ±0.05pF | GJM0334C1E1R4WB01# | | |
| | | | ±0.1pF | GJM0334C1E1R4BB01# | | |
| | | | ±0.25pF | GJM0334C1E1R4CB01# | | |
| | | 1.5pF | ±0.05pF | GJM0334C1E1R5WB01# | | |
| | | | ±0.1pF | GJM0334C1E1R5BB01# | | |
| | | | ±0.25pF | GJM0334C1E1R5CB01# | | |
| | | 1.6pF | ±0.05pF | GJM0334C1E1R6WB01# | | |
| | | | ±0.1pF | GJM0334C1E1R6BB01# | | |
| ±0.25pF | GJM0334C1E1R6CB01# | | | | | |
| 1.7pF | ±0.05pF | GJM0334C1E1R7WB01# | | | | |
| | ±0.1pF | GJM0334C1E1R7BB01# | | | | |
| | ±0.25pF | GJM0334C1E1R7CB01# | | | | |
| 1.8pF | ±0.05pF | GJM0334C1E1R8WB01# | | | | |
| | ±0.1pF | GJM0334C1E1R8BB01# | | | | |
| | ±0.25pF | GJM0334C1E1R8CB01# | | | | |
| 1.9pF | ±0.05pF | GJM0334C1E1R9WB01# | | | | |
| | ±0.1pF | GJM0334C1E1R9BB01# | | | | |
| | ±0.25pF | GJM0334C1E1R9CB01# | | | | |
| 2.0pF | ±0.05pF | GJM0334C1E2R0WB01# | | | | |
| | ±0.1pF | GJM0334C1E2R0BB01# | | | | |

Part number # indicates the package specification code.

For General Purpose GRM Series
 Capacitor Array GNM Series
 Low ESL LLD Series
 High-Q Type GJM Series
 High Frequency GQM Series
 Monolithic Microchip GMA Series
 For Bonding GMD Series
 Product Information

GJM Series Temperature Compensating Type HiQ Part Number List

(→ ■ 0.6x0.3mm)

| T max. | Rated Voltage | TC Code | Cap. | Tol. | Part Number |
|--------|--------------------|---------|---------|--------------------|--------------------|
| 0.33mm | 25Vdc | CK | 2.0pF | ±0.25pF | GJM0334C1E2R0CB01# |
| | | | | | |
| | | CJ | 2.1pF | ±0.05pF | GJM0333C1E2R1WB01# |
| | | | | ±0.1pF | GJM0333C1E2R1BB01# |
| | | | | ±0.25pF | GJM0333C1E2R1CB01# |
| | | | 2.2pF | ±0.05pF | GJM0333C1E2R2WB01# |
| | | | | ±0.1pF | GJM0333C1E2R2BB01# |
| | | | | ±0.25pF | GJM0333C1E2R2CB01# |
| | | | 2.3pF | ±0.05pF | GJM0333C1E2R3WB01# |
| | | | | ±0.1pF | GJM0333C1E2R3BB01# |
| | | | | ±0.25pF | GJM0333C1E2R3CB01# |
| | | | 2.4pF | ±0.05pF | GJM0333C1E2R4WB01# |
| | | | | ±0.1pF | GJM0333C1E2R4BB01# |
| | | | | ±0.25pF | GJM0333C1E2R4CB01# |
| | | | 2.5pF | ±0.05pF | GJM0333C1E2R5WB01# |
| | | | | ±0.1pF | GJM0333C1E2R5BB01# |
| | | | | ±0.25pF | GJM0333C1E2R5CB01# |
| | | | 2.6pF | ±0.05pF | GJM0333C1E2R6WB01# |
| | | | | ±0.1pF | GJM0333C1E2R6BB01# |
| | | | | ±0.25pF | GJM0333C1E2R6CB01# |
| | | | 2.7pF | ±0.05pF | GJM0333C1E2R7WB01# |
| | | | | ±0.1pF | GJM0333C1E2R7BB01# |
| | | | | ±0.25pF | GJM0333C1E2R7CB01# |
| | | | 2.8pF | ±0.05pF | GJM0333C1E2R8WB01# |
| | | | | ±0.1pF | GJM0333C1E2R8BB01# |
| | | | | ±0.25pF | GJM0333C1E2R8CB01# |
| | | | 2.9pF | ±0.05pF | GJM0333C1E2R9WB01# |
| | | | | ±0.1pF | GJM0333C1E2R9BB01# |
| | | | | ±0.25pF | GJM0333C1E2R9CB01# |
| | | | 3.0pF | ±0.05pF | GJM0333C1E3R0WB01# |
| | | | | ±0.1pF | GJM0333C1E3R0BB01# |
| | | | | ±0.25pF | GJM0333C1E3R0CB01# |
| | | | 3.1pF | ±0.05pF | GJM0333C1E3R1WB01# |
| | | | | ±0.1pF | GJM0333C1E3R1BB01# |
| | | | | ±0.25pF | GJM0333C1E3R1CB01# |
| | | | 3.2pF | ±0.05pF | GJM0333C1E3R2WB01# |
| | | | | ±0.1pF | GJM0333C1E3R2BB01# |
| | | | | ±0.25pF | GJM0333C1E3R2CB01# |
| | | | 3.3pF | ±0.05pF | GJM0333C1E3R3WB01# |
| | | | | ±0.1pF | GJM0333C1E3R3BB01# |
| | | | | ±0.25pF | GJM0333C1E3R3CB01# |
| | | | 3.4pF | ±0.05pF | GJM0333C1E3R4WB01# |
| | | | | ±0.1pF | GJM0333C1E3R4BB01# |
| | | | | ±0.25pF | GJM0333C1E3R4CB01# |
| | | | 3.5pF | ±0.05pF | GJM0333C1E3R5WB01# |
| | | | | ±0.1pF | GJM0333C1E3R5BB01# |
| | | | | ±0.25pF | GJM0333C1E3R5CB01# |
| | | | 3.6pF | ±0.05pF | GJM0333C1E3R6WB01# |
| | | | | ±0.1pF | GJM0333C1E3R6BB01# |
| | | | | ±0.25pF | GJM0333C1E3R6CB01# |
| | | 3.7pF | ±0.05pF | GJM0333C1E3R7WB01# | |
| | | | ±0.1pF | GJM0333C1E3R7BB01# | |
| | | | ±0.25pF | GJM0333C1E3R7CB01# | |
| | | 3.8pF | ±0.05pF | GJM0333C1E3R8WB01# | |
| ±0.1pF | GJM0333C1E3R8BB01# | | | | |

| T max. | Rated Voltage | TC Code | Cap. | Tol. | Part Number |
|--------|---------------|---------|---------|--------------------|--------------------|
| 0.33mm | 25Vdc | CJ | 3.8pF | ±0.25pF | GJM0333C1E3R8CB01# |
| | | | | | |
| | | CH | 3.9pF | ±0.05pF | GJM0333C1E3R9WB01# |
| | | | | ±0.1pF | GJM0333C1E3R9BB01# |
| | | | | ±0.25pF | GJM0333C1E3R9CB01# |
| | | | 4.0pF | ±0.05pF | GJM0332C1E4R0WB01# |
| | | | | ±0.1pF | GJM0332C1E4R0BB01# |
| | | | | ±0.25pF | GJM0332C1E4R0CB01# |
| | | | 4.1pF | ±0.05pF | GJM0332C1E4R1WB01# |
| | | | | ±0.1pF | GJM0332C1E4R1BB01# |
| | | | | ±0.25pF | GJM0332C1E4R1CB01# |
| | | | 4.2pF | ±0.05pF | GJM0332C1E4R2WB01# |
| | | | | ±0.1pF | GJM0332C1E4R2BB01# |
| | | | | ±0.25pF | GJM0332C1E4R2CB01# |
| | | | 4.3pF | ±0.05pF | GJM0332C1E4R3WB01# |
| | | | | ±0.1pF | GJM0332C1E4R3BB01# |
| | | | | ±0.25pF | GJM0332C1E4R3CB01# |
| | | | 4.4pF | ±0.05pF | GJM0332C1E4R4WB01# |
| | | | | ±0.1pF | GJM0332C1E4R4BB01# |
| | | | | ±0.25pF | GJM0332C1E4R4CB01# |
| | | | 4.5pF | ±0.05pF | GJM0332C1E4R5WB01# |
| | | | | ±0.1pF | GJM0332C1E4R5BB01# |
| | | | | ±0.25pF | GJM0332C1E4R5CB01# |
| | | | 4.6pF | ±0.05pF | GJM0332C1E4R6WB01# |
| | | | | ±0.1pF | GJM0332C1E4R6BB01# |
| | | | | ±0.25pF | GJM0332C1E4R6CB01# |
| | | | 4.7pF | ±0.05pF | GJM0332C1E4R7WB01# |
| | | | | ±0.1pF | GJM0332C1E4R7BB01# |
| | | | | ±0.25pF | GJM0332C1E4R7CB01# |
| | | | 4.8pF | ±0.05pF | GJM0332C1E4R8WB01# |
| | | | | ±0.1pF | GJM0332C1E4R8BB01# |
| | | | | ±0.25pF | GJM0332C1E4R8CB01# |
| | | | 4.9pF | ±0.05pF | GJM0332C1E4R9WB01# |
| | | | | ±0.1pF | GJM0332C1E4R9BB01# |
| | | | | ±0.25pF | GJM0332C1E4R9CB01# |
| | | | 5.0pF | ±0.05pF | GJM0332C1E5R0WB01# |
| | | | | ±0.1pF | GJM0332C1E5R0BB01# |
| | | | | ±0.25pF | GJM0332C1E5R0CB01# |
| | | | 5.1pF | ±0.05pF | GJM0332C1E5R1WB01# |
| | | | | ±0.1pF | GJM0332C1E5R1BB01# |
| | | | | ±0.25pF | GJM0332C1E5R1CB01# |
| | | | 5.2pF | ±0.05pF | GJM0332C1E5R2WB01# |
| | | | | ±0.1pF | GJM0332C1E5R2BB01# |
| | | | | ±0.25pF | GJM0332C1E5R2CB01# |
| | | | 5.3pF | ±0.05pF | GJM0332C1E5R3WB01# |
| | | | | ±0.1pF | GJM0332C1E5R3BB01# |
| | | | | ±0.25pF | GJM0332C1E5R3CB01# |
| | | | 5.4pF | ±0.05pF | GJM0332C1E5R4WB01# |
| | | | | ±0.1pF | GJM0332C1E5R4BB01# |
| | | | | ±0.25pF | GJM0332C1E5R4CB01# |
| | | 5.5pF | ±0.05pF | GJM0332C1E5R5WB01# | |
| | | | | | |

Part number # indicates the package specification code.

GJM Series Temperature Compensating Type HiQ Part Number List

(→ ■ 0.6x0.3mm)

| T max. | Rated Voltage | TC Code | Cap. | Tol. | Part Number |
|--------|---------------|---------|-------|---------|---------------------------|
| 0.33mm | 25Vdc | CH | 5.5pF | ±0.1pF | GJM0332C1E5R5BB01# |
| | | | | ±0.25pF | GJM0332C1E5R5CB01# |
| | | | | ±0.5pF | GJM0332C1E5R5DB01# |
| | | | 5.6pF | ±0.05pF | GJM0332C1E5R6WB01# |
| | | | | ±0.1pF | GJM0332C1E5R6BB01# |
| | | | | ±0.25pF | GJM0332C1E5R6CB01# |
| | | | 5.7pF | ±0.05pF | GJM0332C1E5R7WB01# |
| | | | | ±0.1pF | GJM0332C1E5R7BB01# |
| | | | | ±0.25pF | GJM0332C1E5R7CB01# |
| | | | 5.8pF | ±0.05pF | GJM0332C1E5R8WB01# |
| | | | | ±0.1pF | GJM0332C1E5R8BB01# |
| | | | | ±0.25pF | GJM0332C1E5R8CB01# |
| | | | 5.9pF | ±0.05pF | GJM0332C1E5R9WB01# |
| | | | | ±0.1pF | GJM0332C1E5R9BB01# |
| | | | | ±0.25pF | GJM0332C1E5R9CB01# |
| | | | 6.0pF | ±0.05pF | GJM0332C1E6R0WB01# |
| | | | | ±0.1pF | GJM0332C1E6R0BB01# |
| | | | | ±0.25pF | GJM0332C1E6R0CB01# |
| | | | 6.1pF | ±0.05pF | GJM0332C1E6R1WB01# |
| | | | | ±0.1pF | GJM0332C1E6R1BB01# |
| | | | | ±0.25pF | GJM0332C1E6R1CB01# |
| | | | 6.2pF | ±0.05pF | GJM0332C1E6R2WB01# |
| | | | | ±0.1pF | GJM0332C1E6R2BB01# |
| | | | | ±0.25pF | GJM0332C1E6R2CB01# |
| | | | 6.3pF | ±0.05pF | GJM0332C1E6R3WB01# |
| | | | | ±0.1pF | GJM0332C1E6R3BB01# |
| | | | | ±0.25pF | GJM0332C1E6R3CB01# |
| | | | 6.4pF | ±0.05pF | GJM0332C1E6R4WB01# |
| | | | | ±0.1pF | GJM0332C1E6R4BB01# |
| | | | | ±0.25pF | GJM0332C1E6R4CB01# |
| | | | 6.5pF | ±0.05pF | GJM0332C1E6R5WB01# |
| | | | | ±0.1pF | GJM0332C1E6R5BB01# |
| | | | | ±0.25pF | GJM0332C1E6R5CB01# |
| | | | 6.6pF | ±0.05pF | GJM0332C1E6R6WB01# |
| | | | | ±0.1pF | GJM0332C1E6R6BB01# |
| | | | | ±0.25pF | GJM0332C1E6R6CB01# |
| | | | 6.7pF | ±0.05pF | GJM0332C1E6R7WB01# |
| | | | | ±0.1pF | GJM0332C1E6R7BB01# |
| | | | | ±0.25pF | GJM0332C1E6R7CB01# |
| | | | 6.8pF | ±0.05pF | GJM0332C1E6R8WB01# |
| | | | | ±0.1pF | GJM0332C1E6R8BB01# |
| | | | | ±0.25pF | GJM0332C1E6R8CB01# |

| T max. | Rated Voltage | TC Code | Cap. | Tol. | Part Number |
|--------|---------------|---------|---------|---------|---------------------------|
| 0.33mm | 25Vdc | CH | 6.8pF | ±0.5pF | GJM0332C1E6R8DB01# |
| | | | | ±0.05pF | GJM0332C1E6R9WB01# |
| | | | | ±0.1pF | GJM0332C1E6R9BB01# |
| | | | 6.9pF | ±0.25pF | GJM0332C1E6R9CB01# |
| | | | | ±0.5pF | GJM0332C1E6R9DB01# |
| | | | | 7.0pF | ±0.05pF |
| | | | ±0.1pF | | GJM0332C1E7R0BB01# |
| | | | ±0.25pF | | GJM0332C1E7R0CB01# |
| | | | 7.1pF | ±0.05pF | GJM0332C1E7R1WB01# |
| | | | | ±0.1pF | GJM0332C1E7R1BB01# |
| | | | | ±0.25pF | GJM0332C1E7R1CB01# |
| | | | 7.2pF | ±0.05pF | GJM0332C1E7R2WB01# |
| | | | | ±0.1pF | GJM0332C1E7R2BB01# |
| | | | | ±0.25pF | GJM0332C1E7R2CB01# |
| | | | 7.3pF | ±0.05pF | GJM0332C1E7R3WB01# |
| | | | | ±0.1pF | GJM0332C1E7R3BB01# |
| | | | | ±0.25pF | GJM0332C1E7R3CB01# |
| | | | 7.4pF | ±0.05pF | GJM0332C1E7R4WB01# |
| | | | | ±0.1pF | GJM0332C1E7R4BB01# |
| | | | | ±0.25pF | GJM0332C1E7R4CB01# |
| | | | 7.5pF | ±0.05pF | GJM0332C1E7R5WB01# |
| | | | | ±0.1pF | GJM0332C1E7R5BB01# |
| | | | | ±0.25pF | GJM0332C1E7R5CB01# |
| | | | 7.6pF | ±0.05pF | GJM0332C1E7R6WB01# |
| | | | | ±0.1pF | GJM0332C1E7R6BB01# |
| | | | | ±0.25pF | GJM0332C1E7R6CB01# |
| | | | 7.7pF | ±0.05pF | GJM0332C1E7R7WB01# |
| | | | | ±0.1pF | GJM0332C1E7R7BB01# |
| | | | | ±0.25pF | GJM0332C1E7R7CB01# |
| | | | 7.8pF | ±0.05pF | GJM0332C1E7R8WB01# |
| | | | | ±0.1pF | GJM0332C1E7R8BB01# |
| | | | | ±0.25pF | GJM0332C1E7R8CB01# |
| | | | 7.9pF | ±0.05pF | GJM0332C1E7R9WB01# |
| | | | | ±0.1pF | GJM0332C1E7R9BB01# |
| | | | | ±0.25pF | GJM0332C1E7R9CB01# |
| | | | 8.0pF | ±0.05pF | GJM0332C1E8R0WB01# |
| | | | | ±0.1pF | GJM0332C1E8R0BB01# |
| | | | | ±0.25pF | GJM0332C1E8R0CB01# |
| | | | 8.1pF | ±0.05pF | GJM0332C1E8R1WB01# |
| | | | | ±0.1pF | GJM0332C1E8R1BB01# |
| | | | | ±0.25pF | GJM0332C1E8R1CB01# |
| | | | 8.2pF | ±0.05pF | GJM0332C1E8R2WB01# |

Part number # indicates the package specification code.

For General Purpose GRM Series
 Capacitor Array GNM Series
 Low ESL LLQ Series
 High-Q Type GMI Series
 High Frequency GQM Series
 Monolithic Microchip GMA Series
 For Bonding GMD Series
 Product Information

GJM Series Temperature Compensating Type HiQ Part Number List

(→ ■ 0.6x0.3mm)

| T max. | Rated Voltage | TC Code | Cap. | Tol. | Part Number |
|--------|---------------|---------|-------|---------|--------------------|
| 0.33mm | 25Vdc | CH | 8.2pF | ±0.1pF | GJM0332C1E8R2BB01# |
| | | | | ±0.25pF | GJM0332C1E8R2CB01# |
| | | | | ±0.5pF | GJM0332C1E8R2DB01# |
| | | | 8.3pF | ±0.05pF | GJM0332C1E8R3WB01# |
| | | | | ±0.1pF | GJM0332C1E8R3BB01# |
| | | | | ±0.25pF | GJM0332C1E8R3CB01# |
| | | | 8.4pF | ±0.05pF | GJM0332C1E8R4WB01# |
| | | | | ±0.1pF | GJM0332C1E8R4BB01# |
| | | | | ±0.25pF | GJM0332C1E8R4CB01# |
| | | | 8.5pF | ±0.05pF | GJM0332C1E8R5WB01# |
| | | | | ±0.1pF | GJM0332C1E8R5BB01# |
| | | | | ±0.25pF | GJM0332C1E8R5CB01# |
| | | | 8.6pF | ±0.05pF | GJM0332C1E8R6WB01# |
| | | | | ±0.1pF | GJM0332C1E8R6BB01# |
| | | | | ±0.25pF | GJM0332C1E8R6CB01# |
| | | | 8.7pF | ±0.05pF | GJM0332C1E8R7WB01# |
| | | | | ±0.1pF | GJM0332C1E8R7BB01# |
| | | | | ±0.25pF | GJM0332C1E8R7CB01# |
| | | | 8.8pF | ±0.05pF | GJM0332C1E8R8WB01# |
| | | | | ±0.1pF | GJM0332C1E8R8BB01# |
| | | | | ±0.25pF | GJM0332C1E8R8CB01# |
| | | | 8.9pF | ±0.05pF | GJM0332C1E8R9WB01# |
| | | | | ±0.1pF | GJM0332C1E8R9BB01# |
| | | | | ±0.25pF | GJM0332C1E8R9CB01# |
| | | | 9.0pF | ±0.05pF | GJM0332C1E9R0WB01# |
| | | | | ±0.1pF | GJM0332C1E9R0BB01# |
| | | | | ±0.25pF | GJM0332C1E9R0CB01# |
| | | | 9.1pF | ±0.05pF | GJM0332C1E9R1WB01# |
| | | | | ±0.1pF | GJM0332C1E9R1BB01# |
| | | | | ±0.25pF | GJM0332C1E9R1CB01# |
| | | | 9.2pF | ±0.05pF | GJM0332C1E9R2WB01# |
| | | | | ±0.1pF | GJM0332C1E9R2BB01# |
| | | | | ±0.25pF | GJM0332C1E9R2CB01# |
| | | | 9.3pF | ±0.05pF | GJM0332C1E9R3WB01# |
| | | | | ±0.1pF | GJM0332C1E9R3BB01# |
| | | | | ±0.25pF | GJM0332C1E9R3CB01# |
| | | | 9.4pF | ±0.05pF | GJM0332C1E9R4WB01# |
| | | | | ±0.1pF | GJM0332C1E9R4BB01# |
| | | | | ±0.25pF | GJM0332C1E9R4CB01# |
| | | | 9.5pF | ±0.05pF | GJM0332C1E9R5WB01# |
| | | | | ±0.1pF | GJM0332C1E9R5BB01# |
| | | | | ±0.25pF | GJM0332C1E9R5CB01# |

| T max. | Rated Voltage | TC Code | Cap. | Tol. | Part Number | | | |
|--------|---------------|--------------------|---------|---------|--------------------|--------------------|--------------------|--------------------|
| 0.33mm | 25Vdc | CH | 9.5pF | ±0.5pF | GJM0332C1E9R5DB01# | | | |
| | | | | ±0.05pF | GJM0332C1E9R6WB01# | | | |
| | | | | ±0.1pF | GJM0332C1E9R6BB01# | | | |
| | | | 9.6pF | ±0.25pF | GJM0332C1E9R6CB01# | | | |
| | | | | ±0.5pF | GJM0332C1E9R6DB01# | | | |
| | | | | 9.7pF | ±0.05pF | GJM0332C1E9R7WB01# | | |
| | | | ±0.1pF | | GJM0332C1E9R7BB01# | | | |
| | | | ±0.25pF | | GJM0332C1E9R7CB01# | | | |
| | | | 9.8pF | ±0.05pF | GJM0332C1E9R8WB01# | | | |
| | | | | ±0.1pF | GJM0332C1E9R8BB01# | | | |
| | | | | ±0.25pF | GJM0332C1E9R8CB01# | | | |
| | | | 9.9pF | ±0.05pF | GJM0332C1E9R9WB01# | | | |
| | | | | ±0.1pF | GJM0332C1E9R9BB01# | | | |
| | | | | ±0.25pF | GJM0332C1E9R9CB01# | | | |
| | | | 10pF | ±2% | GJM0332C1E100GB01# | | | |
| | | | | ±5% | GJM0332C1E100JB01# | | | |
| | | | | 11pF | ±2% | GJM0332C1E110GB01# | | |
| | | | ±5% | | GJM0332C1E110JB01# | | | |
| | | | 12pF | | ±2% | GJM0332C1E120GB01# | | |
| | | | | ±5% | GJM0332C1E120JB01# | | | |
| | | | | 13pF | ±2% | GJM0332C1E130GB01# | | |
| | | | ±5% | | GJM0332C1E130JB01# | | | |
| | | | 15pF | | ±2% | GJM0332C1E150GB01# | | |
| | | | | ±5% | GJM0332C1E150JB01# | | | |
| | | | | 16pF | ±2% | GJM0332C1E160GB01# | | |
| | | | ±5% | | GJM0332C1E160JB01# | | | |
| | | | 18pF | | ±2% | GJM0332C1E180GB01# | | |
| | | | | ±5% | GJM0332C1E180JB01# | | | |
| | | | | 20pF | ±2% | GJM0332C1E200GB01# | | |
| | | | ±5% | | GJM0332C1E200JB01# | | | |
| | | | 6.3Vdc | | C0G | 22pF | ±2% | GJM0335C0J220GB01# |
| | | | | ±5% | | | GJM0335C0J220JB01# | |
| | | | | 24pF | | ±2% | GJM0335C0J240GB01# | |
| | | | | | | ±5% | GJM0335C0J240JB01# | |
| | | | | 27pF | | ±2% | GJM0335C0J270GB01# | |
| | | | | | | ±5% | GJM0335C0J270JB01# | |
| | | | | 30pF | | ±2% | GJM0335C0J300GB01# | |
| | | | | | | ±5% | GJM0335C0J300JB01# | |
| | | | | 33pF | | ±2% | GJM0335C0J330GB01# | |
| | | | | | | ±5% | GJM0335C0J330JB01# | |
| | | | | CH | | 22pF | ±2% | GJM0332C0J220GB01# |
| | | | | | | | ±5% | GJM0332C0J220JB01# |
| 24pF | ±2% | GJM0332C0J240GB01# | | | | | | |
| | ±5% | GJM0332C0J240JB01# | | | | | | |
| 27pF | ±2% | GJM0332C0J270GB01# | | | | | | |
| | ±5% | GJM0332C0J270JB01# | | | | | | |
| 30pF | ±2% | GJM0332C0J300GB01# | | | | | | |
| | ±5% | GJM0332C0J300JB01# | | | | | | |

For General Purpose GRM Series

Capacitor Array GNM Series

Low ESL LL□ Series

High-Q Type GJM Series

High Frequency GQM Series

Monolithic Microchip GMA Series

For Bonding GMD Series

Product Information

Part number # indicates the package specification code.

GJM Series Temperature Compensating Type HiQ Part Number List

■ 1.0x0.5mm

| T max. | Rated Voltage | TC Code | Cap. | Tol. | Part Number |
|--------|---------------|--------------------|-------|---------|--------------------|
| 0.55mm | 50Vdc | C0G | 0.1pF | ±0.05pF | GJM1555C1HR10WB01# |
| | | | | ±0.1pF | GJM1555C1HR10BB01# |
| | | | 0.2pF | ±0.05pF | GJM1555C1HR20WB01# |
| | | | | ±0.1pF | GJM1555C1HR20BB01# |
| | | | 0.3pF | ±0.05pF | GJM1555C1HR30WB01# |
| | | | | ±0.1pF | GJM1555C1HR30BB01# |
| | | | 0.4pF | ±0.05pF | GJM1555C1HR40WB01# |
| | | | | ±0.1pF | GJM1555C1HR40BB01# |
| | | | 0.5pF | ±0.05pF | GJM1555C1HR50WB01# |
| | | | | ±0.1pF | GJM1555C1HR50BB01# |
| | | | 0.6pF | ±0.05pF | GJM1555C1HR60WB01# |
| | | | | ±0.1pF | GJM1555C1HR60BB01# |
| | | | 0.7pF | ±0.05pF | GJM1555C1HR70WB01# |
| | | | | ±0.1pF | GJM1555C1HR70BB01# |
| | | | 0.8pF | ±0.05pF | GJM1555C1HR80WB01# |
| | | | | ±0.1pF | GJM1555C1HR80BB01# |
| | | | 0.9pF | ±0.05pF | GJM1555C1HR90WB01# |
| | | | | ±0.1pF | GJM1555C1HR90BB01# |
| | | | 1.0pF | ±0.05pF | GJM1555C1H1R0WB01# |
| | | | | ±0.1pF | GJM1555C1H1R0BB01# |
| | | | | ±0.25pF | GJM1555C1H1R0CB01# |
| | | | 1.1pF | ±0.05pF | GJM1555C1H1R1WB01# |
| | | | | ±0.1pF | GJM1555C1H1R1BB01# |
| | | | | ±0.25pF | GJM1555C1H1R1CB01# |
| | | | 1.2pF | ±0.05pF | GJM1555C1H1R2WB01# |
| | | | | ±0.1pF | GJM1555C1H1R2BB01# |
| | | | | ±0.25pF | GJM1555C1H1R2CB01# |
| | | | 1.3pF | ±0.05pF | GJM1555C1H1R3WB01# |
| | | | | ±0.1pF | GJM1555C1H1R3BB01# |
| | | | | ±0.25pF | GJM1555C1H1R3CB01# |
| | | | 1.4pF | ±0.05pF | GJM1555C1H1R4WB01# |
| | | | | ±0.1pF | GJM1555C1H1R4BB01# |
| | | | | ±0.25pF | GJM1555C1H1R4CB01# |
| | | | 1.5pF | ±0.05pF | GJM1555C1H1R5WB01# |
| | | | | ±0.1pF | GJM1555C1H1R5BB01# |
| | | | | ±0.25pF | GJM1555C1H1R5CB01# |
| | | | 1.6pF | ±0.05pF | GJM1555C1H1R6WB01# |
| | | | | ±0.1pF | GJM1555C1H1R6BB01# |
| | | | | ±0.25pF | GJM1555C1H1R6CB01# |
| | | | 1.7pF | ±0.05pF | GJM1555C1H1R7WB01# |
| | | | | ±0.1pF | GJM1555C1H1R7BB01# |
| | | | | ±0.25pF | GJM1555C1H1R7CB01# |
| | | | 1.8pF | ±0.05pF | GJM1555C1H1R8WB01# |
| | | | | ±0.1pF | GJM1555C1H1R8BB01# |
| | | | | ±0.25pF | GJM1555C1H1R8CB01# |
| | | | 1.9pF | ±0.05pF | GJM1555C1H1R9WB01# |
| | | | | ±0.1pF | GJM1555C1H1R9BB01# |
| | | | | ±0.25pF | GJM1555C1H1R9CB01# |
| 2.0pF | ±0.05pF | GJM1555C1H2R0WB01# | | | |
| | ±0.1pF | GJM1555C1H2R0BB01# | | | |
| | ±0.25pF | GJM1555C1H2R0CB01# | | | |
| 2.1pF | ±0.05pF | GJM1555C1H2R1WB01# | | | |

| T max. | Rated Voltage | TC Code | Cap. | Tol. | Part Number |
|--------|---------------|---------|-------|---------|--------------------|
| 0.55mm | 50Vdc | C0G | 2.1pF | ±0.1pF | GJM1555C1H2R1BB01# |
| | | | | ±0.25pF | GJM1555C1H2R1CB01# |
| | | | 2.2pF | ±0.05pF | GJM1555C1H2R2WB01# |
| | | | | ±0.1pF | GJM1555C1H2R2BB01# |
| | | | 2.3pF | ±0.05pF | GJM1555C1H2R3WB01# |
| | | | | ±0.1pF | GJM1555C1H2R3BB01# |
| | | | 2.4pF | ±0.05pF | GJM1555C1H2R4WB01# |
| | | | | ±0.1pF | GJM1555C1H2R4BB01# |
| | | | 2.5pF | ±0.05pF | GJM1555C1H2R5WB01# |
| | | | | ±0.1pF | GJM1555C1H2R5BB01# |
| | | | 2.6pF | ±0.05pF | GJM1555C1H2R6WB01# |
| | | | | ±0.1pF | GJM1555C1H2R6BB01# |
| | | | 2.7pF | ±0.05pF | GJM1555C1H2R7WB01# |
| | | | | ±0.1pF | GJM1555C1H2R7BB01# |
| | | | 2.8pF | ±0.05pF | GJM1555C1H2R8WB01# |
| | | | | ±0.1pF | GJM1555C1H2R8BB01# |
| | | | 2.9pF | ±0.05pF | GJM1555C1H2R9WB01# |
| | | | | ±0.1pF | GJM1555C1H2R9BB01# |
| | | | 3.0pF | ±0.05pF | GJM1555C1H3R0WB01# |
| | | | | ±0.1pF | GJM1555C1H3R0BB01# |
| | | | 3.1pF | ±0.05pF | GJM1555C1H3R1WB01# |
| | | | | ±0.1pF | GJM1555C1H3R1BB01# |
| | | | 3.2pF | ±0.05pF | GJM1555C1H3R2WB01# |
| | | | | ±0.1pF | GJM1555C1H3R2BB01# |
| | | | 3.3pF | ±0.05pF | GJM1555C1H3R3WB01# |
| | | | | ±0.1pF | GJM1555C1H3R3BB01# |
| | | | 3.4pF | ±0.05pF | GJM1555C1H3R4WB01# |
| | | | | ±0.1pF | GJM1555C1H3R4BB01# |
| | | | 3.5pF | ±0.05pF | GJM1555C1H3R5WB01# |
| | | | | ±0.1pF | GJM1555C1H3R5BB01# |
| | | | 3.6pF | ±0.05pF | GJM1555C1H3R6WB01# |
| | | | | ±0.1pF | GJM1555C1H3R6BB01# |
| | | | 3.7pF | ±0.05pF | GJM1555C1H3R7WB01# |
| | | | | ±0.1pF | GJM1555C1H3R7BB01# |
| | | | 3.8pF | ±0.05pF | GJM1555C1H3R8WB01# |
| | | | | ±0.1pF | GJM1555C1H3R8BB01# |
| | | | 3.9pF | ±0.05pF | GJM1555C1H3R9WB01# |

Part number # indicates the package specification code.

For General Purpose GRM Series
 Capacitor Array GNM Series
 Low ESL LL Series
 High-Q Type GJM Series
 High Frequency GQM Series
 Monolithic Microchip GMA Series
 For Bonding GMD Series
 Product Information

GJM Series Temperature Compensating Type HiQ Part Number List

(→ ■ 1.0x0.5mm)

| T max. | Rated Voltage | TC Code | Cap. | Tol. | Part Number |
|--------|---------------|---------|-------|---------|--------------------|
| 0.55mm | 50Vdc | C0G | 3.9pF | ±0.1pF | GJM1555C1H3R9BB01# |
| | | | | ±0.25pF | GJM1555C1H3R9CB01# |
| | | | 4.0pF | ±0.05pF | GJM1555C1H4R0WB01# |
| | | | | ±0.1pF | GJM1555C1H4R0BB01# |
| | | | | ±0.25pF | GJM1555C1H4R0CB01# |
| | | | | ±0.05pF | GJM1555C1H4R1WB01# |
| | | | 4.1pF | ±0.1pF | GJM1555C1H4R1BB01# |
| | | | | ±0.25pF | GJM1555C1H4R1CB01# |
| | | | | ±0.05pF | GJM1555C1H4R2WB01# |
| | | | 4.2pF | ±0.1pF | GJM1555C1H4R2BB01# |
| | | | | ±0.25pF | GJM1555C1H4R2CB01# |
| | | | | ±0.05pF | GJM1555C1H4R3WB01# |
| | | | 4.3pF | ±0.1pF | GJM1555C1H4R3BB01# |
| | | | | ±0.25pF | GJM1555C1H4R3CB01# |
| | | | | ±0.05pF | GJM1555C1H4R4WB01# |
| | | | 4.4pF | ±0.1pF | GJM1555C1H4R4BB01# |
| | | | | ±0.25pF | GJM1555C1H4R4CB01# |
| | | | | ±0.05pF | GJM1555C1H4R5WB01# |
| | | | 4.5pF | ±0.1pF | GJM1555C1H4R5BB01# |
| | | | | ±0.25pF | GJM1555C1H4R5CB01# |
| | | | | ±0.05pF | GJM1555C1H4R6WB01# |
| | | | 4.6pF | ±0.1pF | GJM1555C1H4R6BB01# |
| | | | | ±0.25pF | GJM1555C1H4R6CB01# |
| | | | | ±0.05pF | GJM1555C1H4R7WB01# |
| | | | 4.7pF | ±0.1pF | GJM1555C1H4R7BB01# |
| | | | | ±0.25pF | GJM1555C1H4R7CB01# |
| | | | | ±0.05pF | GJM1555C1H4R8WB01# |
| | | | 4.8pF | ±0.1pF | GJM1555C1H4R8BB01# |
| | | | | ±0.25pF | GJM1555C1H4R8CB01# |
| | | | | ±0.05pF | GJM1555C1H4R9WB01# |
| | | | 4.9pF | ±0.1pF | GJM1555C1H4R9BB01# |
| | | | | ±0.25pF | GJM1555C1H4R9CB01# |
| | | | | ±0.05pF | GJM1555C1H5R0WB01# |
| | | | 5.0pF | ±0.1pF | GJM1555C1H5R0BB01# |
| | | | | ±0.25pF | GJM1555C1H5R0CB01# |
| | | | | ±0.05pF | GJM1555C1H5R1WB01# |
| | | | 5.1pF | ±0.1pF | GJM1555C1H5R1BB01# |
| | | | | ±0.25pF | GJM1555C1H5R1CB01# |
| | | | | ±0.5pF | GJM1555C1H5R1DB01# |
| | | | | ±0.05pF | GJM1555C1H5R2WB01# |
| | | | 5.2pF | ±0.1pF | GJM1555C1H5R2BB01# |
| | | | | ±0.25pF | GJM1555C1H5R2CB01# |
| | | | | ±0.5pF | GJM1555C1H5R2DB01# |
| | | | | ±0.05pF | GJM1555C1H5R3WB01# |
| | | | 5.3pF | ±0.1pF | GJM1555C1H5R3BB01# |
| | | | | ±0.25pF | GJM1555C1H5R3CB01# |
| | | | | ±0.5pF | GJM1555C1H5R3DB01# |
| | | | | ±0.05pF | GJM1555C1H5R4WB01# |
| | | | 5.4pF | ±0.1pF | GJM1555C1H5R4BB01# |
| | | | | ±0.25pF | GJM1555C1H5R4CB01# |
| | | | | ±0.5pF | GJM1555C1H5R4DB01# |
| | | | | ±0.05pF | GJM1555C1H5R5WB01# |
| | | | 5.5pF | ±0.1pF | GJM1555C1H5R5BB01# |
| | | | | ±0.25pF | GJM1555C1H5R5CB01# |

| T max. | Rated Voltage | TC Code | Cap. | Tol. | Part Number |
|--------|---------------|---------|-------|---------|--------------------|
| 0.55mm | 50Vdc | C0G | 5.5pF | ±0.5pF | GJM1555C1H5R5DB01# |
| | | | | ±0.05pF | GJM1555C1H5R6WB01# |
| | | | 5.6pF | ±0.1pF | GJM1555C1H5R6BB01# |
| | | | | ±0.25pF | GJM1555C1H5R6CB01# |
| | | | | ±0.5pF | GJM1555C1H5R6DB01# |
| | | | | ±0.05pF | GJM1555C1H5R7WB01# |
| | | | 5.7pF | ±0.1pF | GJM1555C1H5R7BB01# |
| | | | | ±0.25pF | GJM1555C1H5R7CB01# |
| | | | | ±0.5pF | GJM1555C1H5R7DB01# |
| | | | | ±0.05pF | GJM1555C1H5R8WB01# |
| | | | 5.8pF | ±0.1pF | GJM1555C1H5R8BB01# |
| | | | | ±0.25pF | GJM1555C1H5R8CB01# |
| | | | | ±0.5pF | GJM1555C1H5R8DB01# |
| | | | | ±0.05pF | GJM1555C1H5R9WB01# |
| | | | 5.9pF | ±0.1pF | GJM1555C1H5R9BB01# |
| | | | | ±0.25pF | GJM1555C1H5R9CB01# |
| | | | | ±0.5pF | GJM1555C1H5R9DB01# |
| | | | | ±0.05pF | GJM1555C1H6R0WB01# |
| | | | 6.0pF | ±0.1pF | GJM1555C1H6R0BB01# |
| | | | | ±0.25pF | GJM1555C1H6R0CB01# |
| | | | | ±0.5pF | GJM1555C1H6R0DB01# |
| | | | | ±0.05pF | GJM1555C1H6R1WB01# |
| | | | 6.1pF | ±0.1pF | GJM1555C1H6R1BB01# |
| | | | | ±0.25pF | GJM1555C1H6R1CB01# |
| | | | | ±0.5pF | GJM1555C1H6R1DB01# |
| | | | | ±0.05pF | GJM1555C1H6R2WB01# |
| | | | 6.2pF | ±0.1pF | GJM1555C1H6R2BB01# |
| | | | | ±0.25pF | GJM1555C1H6R2CB01# |
| | | | | ±0.5pF | GJM1555C1H6R2DB01# |
| | | | | ±0.05pF | GJM1555C1H6R3WB01# |
| | | | 6.3pF | ±0.1pF | GJM1555C1H6R3BB01# |
| | | | | ±0.25pF | GJM1555C1H6R3CB01# |
| | | | | ±0.5pF | GJM1555C1H6R3DB01# |
| | | | | ±0.05pF | GJM1555C1H6R4WB01# |
| | | | 6.4pF | ±0.1pF | GJM1555C1H6R4BB01# |
| | | | | ±0.25pF | GJM1555C1H6R4CB01# |
| | | | | ±0.5pF | GJM1555C1H6R4DB01# |
| | | | | ±0.05pF | GJM1555C1H6R5WB01# |
| | | | 6.5pF | ±0.1pF | GJM1555C1H6R5BB01# |
| | | | | ±0.25pF | GJM1555C1H6R5CB01# |
| | | | | ±0.5pF | GJM1555C1H6R5DB01# |
| | | | | ±0.05pF | GJM1555C1H6R6WB01# |
| | | | 6.6pF | ±0.1pF | GJM1555C1H6R6BB01# |
| | | | | ±0.25pF | GJM1555C1H6R6CB01# |
| | | | | ±0.5pF | GJM1555C1H6R6DB01# |
| | | | | ±0.05pF | GJM1555C1H6R7WB01# |
| | | | 6.7pF | ±0.1pF | GJM1555C1H6R7BB01# |
| | | | | ±0.25pF | GJM1555C1H6R7CB01# |
| | | | | ±0.5pF | GJM1555C1H6R7DB01# |
| | | | | ±0.05pF | GJM1555C1H6R8WB01# |
| | | | 6.8pF | ±0.1pF | GJM1555C1H6R8BB01# |
| | | | | ±0.25pF | GJM1555C1H6R8CB01# |
| | | | | ±0.5pF | GJM1555C1H6R8DB01# |
| | | | | ±0.05pF | GJM1555C1H6R9WB01# |

Part number # indicates the package specification code.

GJM Series Temperature Compensating Type HiQ Part Number List

(→ ■ 1.0x0.5mm)

| T max. | Rated Voltage | TC Code | Cap. | Tol. | Part Number |
|--------|---------------|---------|-------|---------|--------------------|
| 0.55mm | 50Vdc | C0G | 6.9pF | ±0.1pF | GJM1555C1H6R9BB01# |
| | | | | ±0.25pF | GJM1555C1H6R9CB01# |
| | | | | ±0.5pF | GJM1555C1H6R9DB01# |
| | | | 7.0pF | ±0.05pF | GJM1555C1H7R0WB01# |
| | | | | ±0.1pF | GJM1555C1H7R0BB01# |
| | | | | ±0.25pF | GJM1555C1H7R0CB01# |
| | | | 7.1pF | ±0.05pF | GJM1555C1H7R1WB01# |
| | | | | ±0.1pF | GJM1555C1H7R1BB01# |
| | | | | ±0.25pF | GJM1555C1H7R1CB01# |
| | | | 7.2pF | ±0.05pF | GJM1555C1H7R2WB01# |
| | | | | ±0.1pF | GJM1555C1H7R2BB01# |
| | | | | ±0.25pF | GJM1555C1H7R2CB01# |
| | | | 7.3pF | ±0.05pF | GJM1555C1H7R3WB01# |
| | | | | ±0.1pF | GJM1555C1H7R3BB01# |
| | | | | ±0.25pF | GJM1555C1H7R3CB01# |
| | | | 7.4pF | ±0.05pF | GJM1555C1H7R4WB01# |
| | | | | ±0.1pF | GJM1555C1H7R4BB01# |
| | | | | ±0.25pF | GJM1555C1H7R4CB01# |
| | | | 7.5pF | ±0.05pF | GJM1555C1H7R5WB01# |
| | | | | ±0.1pF | GJM1555C1H7R5BB01# |
| | | | | ±0.25pF | GJM1555C1H7R5CB01# |
| | | | 7.6pF | ±0.05pF | GJM1555C1H7R6WB01# |
| | | | | ±0.1pF | GJM1555C1H7R6BB01# |
| | | | | ±0.25pF | GJM1555C1H7R6CB01# |
| | | | 7.7pF | ±0.05pF | GJM1555C1H7R7WB01# |
| | | | | ±0.1pF | GJM1555C1H7R7BB01# |
| | | | | ±0.25pF | GJM1555C1H7R7CB01# |
| | | | 7.8pF | ±0.05pF | GJM1555C1H7R8WB01# |
| | | | | ±0.1pF | GJM1555C1H7R8BB01# |
| | | | | ±0.25pF | GJM1555C1H7R8CB01# |
| | | | 7.9pF | ±0.05pF | GJM1555C1H7R9WB01# |
| | | | | ±0.1pF | GJM1555C1H7R9BB01# |
| | | | | ±0.25pF | GJM1555C1H7R9CB01# |
| | | | 8.0pF | ±0.05pF | GJM1555C1H8R0WB01# |
| | | | | ±0.1pF | GJM1555C1H8R0BB01# |
| | | | | ±0.25pF | GJM1555C1H8R0CB01# |
| | | | 8.1pF | ±0.05pF | GJM1555C1H8R1WB01# |
| | | | | ±0.1pF | GJM1555C1H8R1BB01# |
| | | | | ±0.25pF | GJM1555C1H8R1CB01# |
| | | | 8.2pF | ±0.05pF | GJM1555C1H8R2WB01# |
| | | | | ±0.1pF | GJM1555C1H8R2BB01# |
| | | | | ±0.25pF | GJM1555C1H8R2CB01# |

| T max. | Rated Voltage | TC Code | Cap. | Tol. | Part Number |
|--------|---------------|---------|---------|---------|--------------------|
| 0.55mm | 50Vdc | C0G | 8.2pF | ±0.5pF | GJM1555C1H8R2DB01# |
| | | | | ±0.05pF | GJM1555C1H8R3WB01# |
| | | | | ±0.1pF | GJM1555C1H8R3BB01# |
| | | | 8.3pF | ±0.25pF | GJM1555C1H8R3CB01# |
| | | | | ±0.5pF | GJM1555C1H8R3DB01# |
| | | | | 8.4pF | ±0.05pF |
| | | | ±0.1pF | | GJM1555C1H8R4BB01# |
| | | | ±0.25pF | | GJM1555C1H8R4CB01# |
| | | | 8.5pF | ±0.05pF | GJM1555C1H8R5WB01# |
| | | | | ±0.1pF | GJM1555C1H8R5BB01# |
| | | | | ±0.25pF | GJM1555C1H8R5CB01# |
| | | | 8.6pF | ±0.05pF | GJM1555C1H8R6WB01# |
| | | | | ±0.1pF | GJM1555C1H8R6BB01# |
| | | | | ±0.25pF | GJM1555C1H8R6CB01# |
| | | | 8.7pF | ±0.05pF | GJM1555C1H8R7WB01# |
| | | | | ±0.1pF | GJM1555C1H8R7BB01# |
| | | | | ±0.25pF | GJM1555C1H8R7CB01# |
| | | | 8.8pF | ±0.05pF | GJM1555C1H8R8WB01# |
| | | | | ±0.1pF | GJM1555C1H8R8BB01# |
| | | | | ±0.25pF | GJM1555C1H8R8CB01# |
| | | | 8.9pF | ±0.05pF | GJM1555C1H8R9WB01# |
| | | | | ±0.1pF | GJM1555C1H8R9BB01# |
| | | | | ±0.25pF | GJM1555C1H8R9CB01# |
| | | | 9.0pF | ±0.05pF | GJM1555C1H9R0WB01# |
| | | | | ±0.1pF | GJM1555C1H9R0BB01# |
| | | | | ±0.25pF | GJM1555C1H9R0CB01# |
| | | | 9.1pF | ±0.05pF | GJM1555C1H9R1WB01# |
| | | | | ±0.1pF | GJM1555C1H9R1BB01# |
| | | | | ±0.25pF | GJM1555C1H9R1CB01# |
| | | | 9.2pF | ±0.05pF | GJM1555C1H9R2WB01# |
| | | | | ±0.1pF | GJM1555C1H9R2BB01# |
| | | | | ±0.25pF | GJM1555C1H9R2CB01# |
| | | | 9.3pF | ±0.05pF | GJM1555C1H9R3WB01# |
| | | | | ±0.1pF | GJM1555C1H9R3BB01# |
| | | | | ±0.25pF | GJM1555C1H9R3CB01# |
| | | | 9.4pF | ±0.05pF | GJM1555C1H9R4WB01# |
| | | | | ±0.1pF | GJM1555C1H9R4BB01# |
| | | | | ±0.25pF | GJM1555C1H9R4CB01# |
| | | | 9.5pF | ±0.05pF | GJM1555C1H9R5WB01# |
| | | | | ±0.1pF | GJM1555C1H9R5BB01# |
| | | | | ±0.25pF | GJM1555C1H9R5CB01# |
| | | | 9.6pF | ±0.05pF | GJM1555C1H9R6WB01# |

Part number # indicates the package specification code.

For General Purpose GRM Series
 Capacitor Array GNM Series
 Low ESL LL Series
 High-Q Type GJM Series
 High Frequency GQM Series
 Monolithic Microchip GMA Series
 For Bonding GMD Series
 Product Information

GJM Series Temperature Compensating Type HiQ Part Number List

(→ ■ 1.0x0.5mm)

| T max. | Rated Voltage | TC Code | Cap. | Tol. | Part Number |
|--------|---------------|---------|-------|---------|--------------------|
| 0.55mm | 50Vdc | C0G | 9.6pF | ±0.1pF | GJM1555C1H9R6BB01# |
| | | | | ±0.25pF | GJM1555C1H9R6CB01# |
| | | | | ±0.5pF | GJM1555C1H9R6DB01# |
| | | | 9.7pF | ±0.05pF | GJM1555C1H9R7WB01# |
| | | | | ±0.1pF | GJM1555C1H9R7BB01# |
| | | | | ±0.25pF | GJM1555C1H9R7CB01# |
| | | | 9.8pF | ±0.05pF | GJM1555C1H9R8WB01# |
| | | | | ±0.1pF | GJM1555C1H9R8BB01# |
| | | | | ±0.25pF | GJM1555C1H9R8CB01# |
| | | | 9.9pF | ±0.05pF | GJM1555C1H9R9WB01# |
| | | | | ±0.1pF | GJM1555C1H9R9BB01# |
| | | | | ±0.25pF | GJM1555C1H9R9CB01# |
| | | | 10pF | ±0.05pF | GJM1555C1H9R9DB01# |
| | | | | ±0.1pF | GJM1555C1H100GB01# |
| | | | | ±0.25pF | GJM1555C1H100JB01# |
| | | | 11pF | ±2% | GJM1555C1H110GB01# |
| | | | | ±5% | GJM1555C1H110JB01# |
| | | | 12pF | ±2% | GJM1555C1H120GB01# |
| | | | | ±5% | GJM1555C1H120JB01# |
| | | | 13pF | ±2% | GJM1555C1H130GB01# |
| | | | | ±5% | GJM1555C1H130JB01# |
| | | | 15pF | ±2% | GJM1555C1H150GB01# |
| | | | | ±5% | GJM1555C1H150JB01# |
| | | | 16pF | ±2% | GJM1555C1H160GB01# |
| | | | | ±5% | GJM1555C1H160JB01# |
| | | | 18pF | ±2% | GJM1555C1H180GB01# |
| | | | | ±5% | GJM1555C1H180JB01# |
| | | | 20pF | ±2% | GJM1555C1H200GB01# |
| | | | | ±5% | GJM1555C1H200JB01# |
| | | | 22pF | ±1% | GJM1555C1H220FB01# |
| | | | | ±2% | GJM1555C1H220GB01# |
| | | | | ±5% | GJM1555C1H220JB01# |
| | | | 24pF | ±1% | GJM1555C1H240FB01# |
| | | | | ±2% | GJM1555C1H240GB01# |
| | | | | ±5% | GJM1555C1H240JB01# |
| | | | 27pF | ±1% | GJM1555C1H270FB01# |
| | | | | ±2% | GJM1555C1H270GB01# |
| | | | | ±5% | GJM1555C1H270JB01# |
| | | | 30pF | ±1% | GJM1555C1H300FB01# |
| | | | | ±2% | GJM1555C1H300GB01# |
| | | | | ±5% | GJM1555C1H300JB01# |
| | | | 33pF | ±1% | GJM1555C1H330FB01# |
| | | | | ±2% | GJM1555C1H330GB01# |
| | | | | ±5% | GJM1555C1H330JB01# |
| | | | 36pF | ±1% | GJM1555C1H360FB01# |
| | | | | ±2% | GJM1555C1H360GB01# |
| | | | | ±5% | GJM1555C1H360JB01# |
| | | | 39pF | ±1% | GJM1555C1H390FB01# |
| | | | | ±2% | GJM1555C1H390GB01# |
| | | | | ±5% | GJM1555C1H390JB01# |
| | | | 43pF | ±1% | GJM1555C1H430FB01# |
| | | | | ±2% | GJM1555C1H430GB01# |

| T max. | Rated Voltage | TC Code | Cap. | Tol. | Part Number | |
|---------|--------------------|--------------------|---------|--------------------|--------------------|--------------------|
| 0.55mm | 50Vdc | C0G | 43pF | ±5% | GJM1555C1H430JB01# | |
| | | | | ±1% | GJM1555C1H470FB01# | |
| | | | | ±2% | GJM1555C1H470GB01# | |
| | | | 47pF | ±5% | GJM1555C1H470JB01# | |
| | | | | 0.1pF | ±0.05pF | GJM1554C1HR10WB01# |
| | | | | | ±0.1pF | GJM1554C1HR10BB01# |
| | | | 0.2pF | ±0.05pF | GJM1554C1HR20WB01# | |
| | | | | ±0.1pF | GJM1554C1HR20BB01# | |
| | | | 0.3pF | ±0.05pF | GJM1554C1HR30WB01# | |
| | | | | ±0.1pF | GJM1554C1HR30BB01# | |
| | | | 0.4pF | ±0.05pF | GJM1554C1HR40WB01# | |
| | | | | ±0.1pF | GJM1554C1HR40BB01# | |
| | | 0.5pF | ±0.05pF | GJM1554C1HR50WB01# | | |
| | | | ±0.1pF | GJM1554C1HR50BB01# | | |
| | | 0.6pF | ±0.05pF | GJM1554C1HR60WB01# | | |
| | | | ±0.1pF | GJM1554C1HR60BB01# | | |
| | | 0.7pF | ±0.05pF | GJM1554C1HR70WB01# | | |
| | | | ±0.1pF | GJM1554C1HR70BB01# | | |
| | | 0.8pF | ±0.05pF | GJM1554C1HR80WB01# | | |
| | | | ±0.1pF | GJM1554C1HR80BB01# | | |
| | | 0.9pF | ±0.05pF | GJM1554C1HR90WB01# | | |
| | | | ±0.1pF | GJM1554C1HR90BB01# | | |
| | | 1.0pF | ±0.05pF | GJM1554C1H1R0WB01# | | |
| | | | ±0.1pF | GJM1554C1H1R0BB01# | | |
| | | | ±0.25pF | GJM1554C1H1R0CB01# | | |
| | | 1.1pF | ±0.05pF | GJM1554C1H1R1WB01# | | |
| | | | ±0.1pF | GJM1554C1H1R1BB01# | | |
| | | | ±0.25pF | GJM1554C1H1R1CB01# | | |
| | | 1.2pF | ±0.05pF | GJM1554C1H1R2WB01# | | |
| | | | ±0.1pF | GJM1554C1H1R2BB01# | | |
| | | | ±0.25pF | GJM1554C1H1R2CB01# | | |
| | | 1.3pF | ±0.05pF | GJM1554C1H1R3WB01# | | |
| | | | ±0.1pF | GJM1554C1H1R3BB01# | | |
| | | | ±0.25pF | GJM1554C1H1R3CB01# | | |
| | | 1.4pF | ±0.05pF | GJM1554C1H1R4WB01# | | |
| | | | ±0.1pF | GJM1554C1H1R4BB01# | | |
| | | | ±0.25pF | GJM1554C1H1R4CB01# | | |
| | | 1.5pF | ±0.05pF | GJM1554C1H1R5WB01# | | |
| | | | ±0.1pF | GJM1554C1H1R5BB01# | | |
| | | | ±0.25pF | GJM1554C1H1R5CB01# | | |
| | | 1.6pF | ±0.05pF | GJM1554C1H1R6WB01# | | |
| | | | ±0.1pF | GJM1554C1H1R6BB01# | | |
| ±0.25pF | GJM1554C1H1R6CB01# | | | | | |
| 1.7pF | ±0.05pF | GJM1554C1H1R7WB01# | | | | |
| | ±0.1pF | GJM1554C1H1R7BB01# | | | | |
| | ±0.25pF | GJM1554C1H1R7CB01# | | | | |
| 1.8pF | ±0.05pF | GJM1554C1H1R8WB01# | | | | |
| | ±0.1pF | GJM1554C1H1R8BB01# | | | | |
| | ±0.25pF | GJM1554C1H1R8CB01# | | | | |
| 1.9pF | ±0.05pF | GJM1554C1H1R9WB01# | | | | |
| | ±0.1pF | GJM1554C1H1R9BB01# | | | | |
| | ±0.25pF | GJM1554C1H1R9CB01# | | | | |
| 2.0pF | ±0.05pF | GJM1554C1H2R0WB01# | | | | |
| | ±0.1pF | GJM1554C1H2R0BB01# | | | | |

For General Purpose GRM Series

Capacitor Array GNM Series

Low ESL LL□ Series

High-Q Type GJM Series

High Frequency GQM Series

Monolithic Microchip GMA Series

For Bonding GMD Series

Product Information

Part number # indicates the package specification code.

GJM Series Temperature Compensating Type HiQ Part Number List

(→ ■ 1.0x0.5mm)

| T max. | Rated Voltage | TC Code | Cap. | Tol. | Part Number |
|--------|---------------|---------|---------|---------------------------|---------------------------|
| 0.55mm | 50Vdc | CK | 2.0pF | ±0.25pF | GJM1554C1H2R0CB01# |
| | | | | ±0.05pF | GJM1553C1H2R1WB01# |
| | | CJ | 2.1pF | ±0.05pF | GJM1553C1H2R1WB01# |
| | | | | ±0.1pF | GJM1553C1H2R1BB01# |
| | | | | ±0.25pF | GJM1553C1H2R1CB01# |
| | | 2.2pF | ±0.05pF | GJM1553C1H2R2WB01# | |
| | | | ±0.1pF | GJM1553C1H2R2BB01# | |
| | | | ±0.25pF | GJM1553C1H2R2CB01# | |
| | | 2.3pF | ±0.05pF | GJM1553C1H2R3WB01# | |
| | | | ±0.1pF | GJM1553C1H2R3BB01# | |
| | | | ±0.25pF | GJM1553C1H2R3CB01# | |
| | | 2.4pF | ±0.05pF | GJM1553C1H2R4WB01# | |
| | | | ±0.1pF | GJM1553C1H2R4BB01# | |
| | | | ±0.25pF | GJM1553C1H2R4CB01# | |
| | | 2.5pF | ±0.05pF | GJM1553C1H2R5WB01# | |
| | | | ±0.1pF | GJM1553C1H2R5BB01# | |
| | | | ±0.25pF | GJM1553C1H2R5CB01# | |
| | | 2.6pF | ±0.05pF | GJM1553C1H2R6WB01# | |
| | | | ±0.1pF | GJM1553C1H2R6BB01# | |
| | | | ±0.25pF | GJM1553C1H2R6CB01# | |
| | | 2.7pF | ±0.05pF | GJM1553C1H2R7WB01# | |
| | | | ±0.1pF | GJM1553C1H2R7BB01# | |
| | | | ±0.25pF | GJM1553C1H2R7CB01# | |
| | | 2.8pF | ±0.05pF | GJM1553C1H2R8WB01# | |
| | | | ±0.1pF | GJM1553C1H2R8BB01# | |
| | | | ±0.25pF | GJM1553C1H2R8CB01# | |
| | | 2.9pF | ±0.05pF | GJM1553C1H2R9WB01# | |
| | | | ±0.1pF | GJM1553C1H2R9BB01# | |
| | | | ±0.25pF | GJM1553C1H2R9CB01# | |
| | | 3.0pF | ±0.05pF | GJM1553C1H3R0WB01# | |
| | | | ±0.1pF | GJM1553C1H3R0BB01# | |
| | | | ±0.25pF | GJM1553C1H3R0CB01# | |
| | | 3.1pF | ±0.05pF | GJM1553C1H3R1WB01# | |
| | | | ±0.1pF | GJM1553C1H3R1BB01# | |
| | | | ±0.25pF | GJM1553C1H3R1CB01# | |
| | | 3.2pF | ±0.05pF | GJM1553C1H3R2WB01# | |
| | | | ±0.1pF | GJM1553C1H3R2BB01# | |
| | | | ±0.25pF | GJM1553C1H3R2CB01# | |
| | | 3.3pF | ±0.05pF | GJM1553C1H3R3WB01# | |
| | | | ±0.1pF | GJM1553C1H3R3BB01# | |
| | | | ±0.25pF | GJM1553C1H3R3CB01# | |
| | | 3.4pF | ±0.05pF | GJM1553C1H3R4WB01# | |
| | | | ±0.1pF | GJM1553C1H3R4BB01# | |
| | | | ±0.25pF | GJM1553C1H3R4CB01# | |
| | | 3.5pF | ±0.05pF | GJM1553C1H3R5WB01# | |
| | | | ±0.1pF | GJM1553C1H3R5BB01# | |
| | | | ±0.25pF | GJM1553C1H3R5CB01# | |
| | | 3.6pF | ±0.05pF | GJM1553C1H3R6WB01# | |
| | | | ±0.1pF | GJM1553C1H3R6BB01# | |
| | | | ±0.25pF | GJM1553C1H3R6CB01# | |
| | | 3.7pF | ±0.05pF | GJM1553C1H3R7WB01# | |
| | | | ±0.1pF | GJM1553C1H3R7BB01# | |
| | | | ±0.25pF | GJM1553C1H3R7CB01# | |
| | | 3.8pF | ±0.05pF | GJM1553C1H3R8WB01# | |
| | | | ±0.1pF | GJM1553C1H3R8BB01# | |

| T max. | Rated Voltage | TC Code | Cap. | Tol. | Part Number |
|--------|---------------|---------|---------|---------------------------|---------------------------|
| 0.55mm | 50Vdc | CJ | 3.8pF | ±0.25pF | GJM1553C1H3R8CB01# |
| | | | | ±0.05pF | GJM1553C1H3R9WB01# |
| | | 3.9pF | ±0.05pF | GJM1553C1H3R9WB01# | |
| | | | ±0.1pF | GJM1553C1H3R9BB01# | |
| | | | ±0.25pF | GJM1553C1H3R9CB01# | |
| | | CH | 4.0pF | ±0.05pF | GJM1552C1H4R0WB01# |
| | | | | ±0.1pF | GJM1552C1H4R0BB01# |
| | | | | ±0.25pF | GJM1552C1H4R0CB01# |
| | | 4.1pF | ±0.05pF | GJM1552C1H4R1WB01# | |
| | | | ±0.1pF | GJM1552C1H4R1BB01# | |
| | | | ±0.25pF | GJM1552C1H4R1CB01# | |
| | | 4.2pF | ±0.05pF | GJM1552C1H4R2WB01# | |
| | | | ±0.1pF | GJM1552C1H4R2BB01# | |
| | | | ±0.25pF | GJM1552C1H4R2CB01# | |
| | | 4.3pF | ±0.05pF | GJM1552C1H4R3WB01# | |
| | | | ±0.1pF | GJM1552C1H4R3BB01# | |
| | | | ±0.25pF | GJM1552C1H4R3CB01# | |
| | | 4.4pF | ±0.05pF | GJM1552C1H4R4WB01# | |
| | | | ±0.1pF | GJM1552C1H4R4BB01# | |
| | | | ±0.25pF | GJM1552C1H4R4CB01# | |
| | | 4.5pF | ±0.05pF | GJM1552C1H4R5WB01# | |
| | | | ±0.1pF | GJM1552C1H4R5BB01# | |
| | | | ±0.25pF | GJM1552C1H4R5CB01# | |
| | | 4.6pF | ±0.05pF | GJM1552C1H4R6WB01# | |
| | | | ±0.1pF | GJM1552C1H4R6BB01# | |
| | | | ±0.25pF | GJM1552C1H4R6CB01# | |
| | | 4.7pF | ±0.05pF | GJM1552C1H4R7WB01# | |
| | | | ±0.1pF | GJM1552C1H4R7BB01# | |
| | | | ±0.25pF | GJM1552C1H4R7CB01# | |
| | | 4.8pF | ±0.05pF | GJM1552C1H4R8WB01# | |
| | | | ±0.1pF | GJM1552C1H4R8BB01# | |
| | | | ±0.25pF | GJM1552C1H4R8CB01# | |
| | | 4.9pF | ±0.05pF | GJM1552C1H4R9WB01# | |
| | | | ±0.1pF | GJM1552C1H4R9BB01# | |
| | | | ±0.25pF | GJM1552C1H4R9CB01# | |
| | | 5.0pF | ±0.05pF | GJM1552C1H5R0WB01# | |
| | | | ±0.1pF | GJM1552C1H5R0BB01# | |
| | | | ±0.25pF | GJM1552C1H5R0CB01# | |
| | | 5.1pF | ±0.05pF | GJM1552C1H5R1WB01# | |
| | | | ±0.1pF | GJM1552C1H5R1BB01# | |
| | | | ±0.25pF | GJM1552C1H5R1CB01# | |
| | | 5.2pF | ±0.05pF | GJM1552C1H5R2WB01# | |
| | | | ±0.1pF | GJM1552C1H5R2BB01# | |
| | | | ±0.25pF | GJM1552C1H5R2CB01# | |
| | | 5.3pF | ±0.05pF | GJM1552C1H5R3WB01# | |
| | | | ±0.1pF | GJM1552C1H5R3BB01# | |
| | | | ±0.25pF | GJM1552C1H5R3CB01# | |
| | | 5.4pF | ±0.05pF | GJM1552C1H5R4WB01# | |
| | | | ±0.1pF | GJM1552C1H5R4BB01# | |
| | | | ±0.25pF | GJM1552C1H5R4CB01# | |
| | | 5.5pF | ±0.05pF | GJM1552C1H5R5WB01# | |
| | | | ±0.1pF | GJM1552C1H5R5WB01# | |

Part number # indicates the package specification code.

For General Purpose GRM Series
 Capacitor Array GNM Series
 Low ESL LL Series
 High-Q Type GJM Series
 High Frequency GQM Series
 Monolithic Microchip GMA Series
 For Bonding GMD Series
 Product Information

GJM Series Temperature Compensating Type HiQ Part Number List

(→ ■ 1.0x0.5mm)

| T max. | Rated Voltage | TC Code | Cap. | Tol. | Part Number |
|--------|---------------|---------|-------|---------|--------------------|
| 0.55mm | 50Vdc | CH | 5.5pF | ±0.1pF | GJM1552C1H5R5BB01# |
| | | | | ±0.25pF | GJM1552C1H5R5CB01# |
| | | | | ±0.5pF | GJM1552C1H5R5DB01# |
| | | | 5.6pF | ±0.05pF | GJM1552C1H5R6WB01# |
| | | | | ±0.1pF | GJM1552C1H5R6BB01# |
| | | | | ±0.25pF | GJM1552C1H5R6CB01# |
| | | | 5.7pF | ±0.05pF | GJM1552C1H5R7WB01# |
| | | | | ±0.1pF | GJM1552C1H5R7BB01# |
| | | | | ±0.25pF | GJM1552C1H5R7CB01# |
| | | | 5.8pF | ±0.05pF | GJM1552C1H5R8WB01# |
| | | | | ±0.1pF | GJM1552C1H5R8BB01# |
| | | | | ±0.25pF | GJM1552C1H5R8CB01# |
| | | | 5.9pF | ±0.05pF | GJM1552C1H5R9WB01# |
| | | | | ±0.1pF | GJM1552C1H5R9BB01# |
| | | | | ±0.25pF | GJM1552C1H5R9CB01# |
| | | | 6.0pF | ±0.05pF | GJM1552C1H6R0WB01# |
| | | | | ±0.1pF | GJM1552C1H6R0BB01# |
| | | | | ±0.25pF | GJM1552C1H6R0CB01# |
| | | | 6.1pF | ±0.05pF | GJM1552C1H6R1WB01# |
| | | | | ±0.1pF | GJM1552C1H6R1BB01# |
| | | | | ±0.25pF | GJM1552C1H6R1CB01# |
| | | | 6.2pF | ±0.05pF | GJM1552C1H6R2WB01# |
| | | | | ±0.1pF | GJM1552C1H6R2BB01# |
| | | | | ±0.25pF | GJM1552C1H6R2CB01# |
| | | | 6.3pF | ±0.05pF | GJM1552C1H6R3WB01# |
| | | | | ±0.1pF | GJM1552C1H6R3BB01# |
| | | | | ±0.25pF | GJM1552C1H6R3CB01# |
| | | | 6.4pF | ±0.05pF | GJM1552C1H6R4WB01# |
| | | | | ±0.1pF | GJM1552C1H6R4BB01# |
| | | | | ±0.25pF | GJM1552C1H6R4CB01# |
| | | | 6.5pF | ±0.05pF | GJM1552C1H6R5WB01# |
| | | | | ±0.1pF | GJM1552C1H6R5BB01# |
| | | | | ±0.25pF | GJM1552C1H6R5CB01# |
| | | | 6.6pF | ±0.05pF | GJM1552C1H6R6WB01# |
| | | | | ±0.1pF | GJM1552C1H6R6BB01# |
| | | | | ±0.25pF | GJM1552C1H6R6CB01# |
| | | | 6.7pF | ±0.05pF | GJM1552C1H6R7WB01# |
| | | | | ±0.1pF | GJM1552C1H6R7BB01# |
| | | | | ±0.25pF | GJM1552C1H6R7CB01# |
| | | | 6.8pF | ±0.05pF | GJM1552C1H6R8WB01# |
| | | | | ±0.1pF | GJM1552C1H6R8BB01# |
| | | | | ±0.25pF | GJM1552C1H6R8CB01# |

| T max. | Rated Voltage | TC Code | Cap. | Tol. | Part Number |
|--------|---------------|---------|---------|---------|--------------------|
| 0.55mm | 50Vdc | CH | 6.8pF | ±0.5pF | GJM1552C1H6R8DB01# |
| | | | | ±0.05pF | GJM1552C1H6R9WB01# |
| | | | | ±0.1pF | GJM1552C1H6R9BB01# |
| | | | 6.9pF | ±0.25pF | GJM1552C1H6R9CB01# |
| | | | | ±0.5pF | GJM1552C1H6R9DB01# |
| | | | | 7.0pF | ±0.05pF |
| | | | ±0.1pF | | GJM1552C1H7R0BB01# |
| | | | ±0.25pF | | GJM1552C1H7R0CB01# |
| | | | 7.1pF | ±0.05pF | GJM1552C1H7R1WB01# |
| | | | | ±0.1pF | GJM1552C1H7R1BB01# |
| | | | | ±0.25pF | GJM1552C1H7R1CB01# |
| | | | 7.2pF | ±0.05pF | GJM1552C1H7R2WB01# |
| | | | | ±0.1pF | GJM1552C1H7R2BB01# |
| | | | | ±0.25pF | GJM1552C1H7R2CB01# |
| | | | 7.3pF | ±0.05pF | GJM1552C1H7R3WB01# |
| | | | | ±0.1pF | GJM1552C1H7R3BB01# |
| | | | | ±0.25pF | GJM1552C1H7R3CB01# |
| | | | 7.4pF | ±0.05pF | GJM1552C1H7R4WB01# |
| | | | | ±0.1pF | GJM1552C1H7R4BB01# |
| | | | | ±0.25pF | GJM1552C1H7R4CB01# |
| | | | 7.5pF | ±0.05pF | GJM1552C1H7R5WB01# |
| | | | | ±0.1pF | GJM1552C1H7R5BB01# |
| | | | | ±0.25pF | GJM1552C1H7R5CB01# |
| | | | 7.6pF | ±0.05pF | GJM1552C1H7R6WB01# |
| | | | | ±0.1pF | GJM1552C1H7R6BB01# |
| | | | | ±0.25pF | GJM1552C1H7R6CB01# |
| | | | 7.7pF | ±0.05pF | GJM1552C1H7R7WB01# |
| | | | | ±0.1pF | GJM1552C1H7R7BB01# |
| | | | | ±0.25pF | GJM1552C1H7R7CB01# |
| | | | 7.8pF | ±0.05pF | GJM1552C1H7R8WB01# |
| | | | | ±0.1pF | GJM1552C1H7R8BB01# |
| | | | | ±0.25pF | GJM1552C1H7R8CB01# |
| | | | 7.9pF | ±0.05pF | GJM1552C1H7R9WB01# |
| | | | | ±0.1pF | GJM1552C1H7R9BB01# |
| | | | | ±0.25pF | GJM1552C1H7R9CB01# |
| | | | 8.0pF | ±0.05pF | GJM1552C1H8R0WB01# |
| | | | | ±0.1pF | GJM1552C1H8R0BB01# |
| | | | | ±0.25pF | GJM1552C1H8R0CB01# |
| | | | 8.1pF | ±0.05pF | GJM1552C1H8R1WB01# |
| | | | | ±0.1pF | GJM1552C1H8R1BB01# |
| | | | | ±0.25pF | GJM1552C1H8R1CB01# |
| | | | 8.2pF | ±0.05pF | GJM1552C1H8R2WB01# |
| | | | | ±0.1pF | GJM1552C1H8R2BB01# |
| | | | | ±0.25pF | GJM1552C1H8R2CB01# |

Part number # indicates the package specification code.

GJM Series Temperature Compensating Type HiQ Part Number List

(→ ■ 1.0x0.5mm)

| T max. | Rated Voltage | TC Code | Cap. | Tol. | Part Number |
|--------|---------------|---------|-------|---------|---------------------------|
| 0.55mm | 50Vdc | CH | 8.2pF | ±0.1pF | GJM1552C1H8R2BB01# |
| | | | | ±0.25pF | GJM1552C1H8R2CB01# |
| | | | | ±0.5pF | GJM1552C1H8R2DB01# |
| | | | 8.3pF | ±0.05pF | GJM1552C1H8R3WB01# |
| | | | | ±0.1pF | GJM1552C1H8R3BB01# |
| | | | | ±0.25pF | GJM1552C1H8R3CB01# |
| | | | 8.4pF | ±0.05pF | GJM1552C1H8R4WB01# |
| | | | | ±0.1pF | GJM1552C1H8R4BB01# |
| | | | | ±0.25pF | GJM1552C1H8R4CB01# |
| | | | 8.5pF | ±0.05pF | GJM1552C1H8R5WB01# |
| | | | | ±0.1pF | GJM1552C1H8R5BB01# |
| | | | | ±0.25pF | GJM1552C1H8R5CB01# |
| | | | 8.6pF | ±0.05pF | GJM1552C1H8R6WB01# |
| | | | | ±0.1pF | GJM1552C1H8R6BB01# |
| | | | | ±0.25pF | GJM1552C1H8R6CB01# |
| | | | 8.7pF | ±0.05pF | GJM1552C1H8R7WB01# |
| | | | | ±0.1pF | GJM1552C1H8R7BB01# |
| | | | | ±0.25pF | GJM1552C1H8R7CB01# |
| | | | 8.8pF | ±0.05pF | GJM1552C1H8R8WB01# |
| | | | | ±0.1pF | GJM1552C1H8R8BB01# |
| | | | | ±0.25pF | GJM1552C1H8R8CB01# |
| | | | 8.9pF | ±0.05pF | GJM1552C1H8R9WB01# |
| | | | | ±0.1pF | GJM1552C1H8R9BB01# |
| | | | | ±0.25pF | GJM1552C1H8R9CB01# |
| | | | 9.0pF | ±0.05pF | GJM1552C1H9R0WB01# |
| | | | | ±0.1pF | GJM1552C1H9R0BB01# |
| | | | | ±0.25pF | GJM1552C1H9R0CB01# |
| | | | 9.1pF | ±0.05pF | GJM1552C1H9R1WB01# |
| | | | | ±0.1pF | GJM1552C1H9R1BB01# |
| | | | | ±0.25pF | GJM1552C1H9R1CB01# |
| | | | 9.2pF | ±0.05pF | GJM1552C1H9R2WB01# |
| | | | | ±0.1pF | GJM1552C1H9R2BB01# |
| | | | | ±0.25pF | GJM1552C1H9R2CB01# |
| | | | 9.3pF | ±0.05pF | GJM1552C1H9R3WB01# |
| | | | | ±0.1pF | GJM1552C1H9R3BB01# |
| | | | | ±0.25pF | GJM1552C1H9R3CB01# |
| | | | 9.4pF | ±0.05pF | GJM1552C1H9R4WB01# |
| | | | | ±0.1pF | GJM1552C1H9R4BB01# |
| | | | | ±0.25pF | GJM1552C1H9R4CB01# |
| | | | 9.5pF | ±0.05pF | GJM1552C1H9R5WB01# |
| | | | | ±0.1pF | GJM1552C1H9R5BB01# |
| | | | | ±0.25pF | GJM1552C1H9R5CB01# |

| T max. | Rated Voltage | TC Code | Cap. | Tol. | Part Number |
|--------|---------------|---------------------------|---------|---------|---------------------------|
| 0.55mm | 50Vdc | CH | 9.5pF | ±0.5pF | GJM1552C1H9R5DB01# |
| | | | | ±0.05pF | GJM1552C1H9R6WB01# |
| | | | | ±0.1pF | GJM1552C1H9R6BB01# |
| | | | 9.6pF | ±0.25pF | GJM1552C1H9R6CB01# |
| | | | | ±0.5pF | GJM1552C1H9R6DB01# |
| | | | | 9.7pF | ±0.05pF |
| | | | ±0.1pF | | GJM1552C1H9R7BB01# |
| | | | ±0.25pF | | GJM1552C1H9R7CB01# |
| | | | 9.8pF | ±0.05pF | GJM1552C1H9R8WB01# |
| | | | | ±0.1pF | GJM1552C1H9R8BB01# |
| | | | | ±0.25pF | GJM1552C1H9R8CB01# |
| | | | 9.9pF | ±0.05pF | GJM1552C1H9R9WB01# |
| | | | | ±0.1pF | GJM1552C1H9R9BB01# |
| | | | | ±0.25pF | GJM1552C1H9R9CB01# |
| | | | 10pF | ±2% | GJM1552C1H100GB01# |
| | | | | ±5% | GJM1552C1H100JB01# |
| | | | 11pF | ±2% | GJM1552C1H110GB01# |
| | | | | ±5% | GJM1552C1H110JB01# |
| | | | 12pF | ±2% | GJM1552C1H120GB01# |
| | | | | ±5% | GJM1552C1H120JB01# |
| | | | 13pF | ±2% | GJM1552C1H130GB01# |
| | | | | ±5% | GJM1552C1H130JB01# |
| | | | 15pF | ±2% | GJM1552C1H150GB01# |
| | | | | ±5% | GJM1552C1H150JB01# |
| | | | 16pF | ±2% | GJM1552C1H160GB01# |
| | | | | ±5% | GJM1552C1H160JB01# |
| | | | 18pF | ±2% | GJM1552C1H180GB01# |
| | | | | ±5% | GJM1552C1H180JB01# |
| | | | 20pF | ±2% | GJM1552C1H200GB01# |
| | | | | ±5% | GJM1552C1H200JB01# |
| | | | 22pF | ±1% | GJM1552C1H220FB01# |
| | | | | ±2% | GJM1552C1H220GB01# |
| | | | | ±5% | GJM1552C1H220JB01# |
| | | | 24pF | ±1% | GJM1552C1H240FB01# |
| | | | | ±2% | GJM1552C1H240GB01# |
| | | | | ±5% | GJM1552C1H240JB01# |
| | | | 27pF | ±1% | GJM1552C1H270FB01# |
| | | | | ±2% | GJM1552C1H270GB01# |
| | | | | ±5% | GJM1552C1H270JB01# |
| | | | 30pF | ±1% | GJM1552C1H300FB01# |
| | | | | ±2% | GJM1552C1H300GB01# |
| | | | | ±5% | GJM1552C1H300JB01# |
| | | | 33pF | ±1% | GJM1552C1H330FB01# |
| | | | | ±2% | GJM1552C1H330GB01# |
| | | | | ±5% | GJM1552C1H330JB01# |
| 36pF | ±1% | GJM1552C1H360FB01# | | | |
| | ±2% | GJM1552C1H360GB01# | | | |
| | ±5% | GJM1552C1H360JB01# | | | |
| 39pF | ±1% | GJM1552C1H390FB01# | | | |
| | ±2% | GJM1552C1H390GB01# | | | |
| | ±5% | GJM1552C1H390JB01# | | | |

Part number # indicates the package specification code.

For General Purpose GRM Series
 Capacitor Array GNM Series
 Low ESL LL Series
 High-Q Type GJM Series
 High Frequency GQM Series
 Monolithic Microchip GMA Series
 For Bonding GMD Series
 Product Information

GJM Series Temperature Compensating Type HiQ Part Number List

(→ ■ 1.0x0.5mm)

| T max. | Rated Voltage | TC Code | Cap. | Tol. | Part Number | |
|--------|---------------|---------|------|------|---------------------------|--|
| 0.55mm | 50Vdc | CH | 43pF | ±1% | GJM1552C1H430FB01# | |
| | | | | ±2% | GJM1552C1H430GB01# | |
| | | | | ±5% | GJM1552C1H430JB01# | |
| | | | 47pF | ±1% | GJM1552C1H470FB01# | |
| | | | | ±2% | GJM1552C1H470GB01# | |
| | | | | ±5% | GJM1552C1H470JB01# | |

For General Purpose
GRM Series

Capacitor Array
GNM Series

Low ESL
LLQ Series

High-Q Type
GJM Series

High Frequency
GQM Series

Monolithic Microchip
GMA Series

For Bonding
GMD Series

Product Information

Part number # indicates the package specification code.

Chip Monolithic Ceramic Capacitors

High Frequency GQM Series

HiQ

Capacitor for high frequency suitable for PA designs.

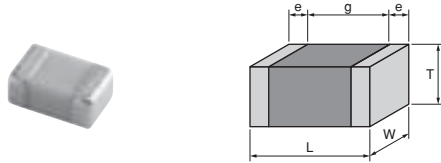

- 1 HiQ and low ESR in UHF and microwave frequency bands.
- 2 Highly conductive copper was adopted for the internal electrodes.
- 3 Product compatible to tight tolerances.
- 4 Achieved high withstand voltages.
- 5 Ideal for improving the characteristics and reducing power consumption in RF equipment.

For General Purpose
GRW Series

Capacitor Array
GNM Series

Low ESL
LLQ Series

High-Q Type
GJM Series

High Frequency
GQM Series

Monolithic Microchip
GMA Series

For Bonding
GMD Series

Product Information

GQM Series Temperature Compensating Type HiQ Part Number List

■ 1.6×0.8mm

| T max. | Rated Voltage | TC Code | Cap. | Tol. | Part Number |
|--------|---------------|--------------------|--------|---------|--------------------|
| 0.8mm | 250Vdc | C0G | 0.1pF | ±0.1pF | GQM1875C2ER10BB12# |
| | | | | ±0.25pF | GQM1875C2ER10CB12# |
| | | | 0.2pF | ±0.1pF | GQM1875C2ER20BB12# |
| | | | | ±0.25pF | GQM1875C2ER20CB12# |
| | | | 0.3pF | ±0.1pF | GQM1875C2ER30BB12# |
| | | | | ±0.25pF | GQM1875C2ER30CB12# |
| | | | 0.4pF | ±0.1pF | GQM1875C2ER40BB12# |
| | | | | ±0.25pF | GQM1875C2ER40CB12# |
| | | | 0.5pF | ±0.1pF | GQM1875C2ER50BB12# |
| | | | | ±0.25pF | GQM1875C2ER50CB12# |
| | | | 0.75pF | ±0.1pF | GQM1875C2ER75BB12# |
| | | | | ±0.25pF | GQM1875C2ER75CB12# |
| | | | 1.0pF | ±0.1pF | GQM1875C2E1R0BB12# |
| | | | | ±0.25pF | GQM1875C2E1R0CB12# |
| | | | 1.1pF | ±0.1pF | GQM1875C2E1R1BB12# |
| | | | | ±0.25pF | GQM1875C2E1R1CB12# |
| | | | 1.2pF | ±0.1pF | GQM1875C2E1R2BB12# |
| | | | | ±0.25pF | GQM1875C2E1R2CB12# |
| | | | 1.3pF | ±0.1pF | GQM1875C2E1R3BB12# |
| | | | | ±0.25pF | GQM1875C2E1R3CB12# |
| | | | 1.5pF | ±0.1pF | GQM1875C2E1R5BB12# |
| | | | | ±0.25pF | GQM1875C2E1R5CB12# |
| | | | 1.6pF | ±0.1pF | GQM1875C2E1R6BB12# |
| | | | | ±0.25pF | GQM1875C2E1R6CB12# |
| | | | 1.8pF | ±0.1pF | GQM1875C2E1R8BB12# |
| | | | | ±0.25pF | GQM1875C2E1R8CB12# |
| | | | 2.0pF | ±0.1pF | GQM1875C2E2R0BB12# |
| | | | | ±0.25pF | GQM1875C2E2R0CB12# |
| | | | 2.2pF | ±0.1pF | GQM1875C2E2R2BB12# |
| | | | | ±0.25pF | GQM1875C2E2R2CB12# |
| | | | 2.4pF | ±0.1pF | GQM1875C2E2R4BB12# |
| | | | | ±0.25pF | GQM1875C2E2R4CB12# |
| | | | 2.7pF | ±0.1pF | GQM1875C2E2R7BB12# |
| | | | | ±0.25pF | GQM1875C2E2R7CB12# |
| | | | 3.0pF | ±0.1pF | GQM1875C2E3R0BB12# |
| | | | | ±0.25pF | GQM1875C2E3R0CB12# |
| | | | 3.3pF | ±0.1pF | GQM1875C2E3R3BB12# |
| | | | | ±0.25pF | GQM1875C2E3R3CB12# |
| | | | 3.6pF | ±0.1pF | GQM1875C2E3R6BB12# |
| | | | | ±0.25pF | GQM1875C2E3R6CB12# |
| | | | 3.9pF | ±0.1pF | GQM1875C2E3R9BB12# |
| | | | | ±0.25pF | GQM1875C2E3R9CB12# |
| | | | 4.0pF | ±0.1pF | GQM1875C2E4R0BB12# |
| | | | | ±0.25pF | GQM1875C2E4R0CB12# |
| | | | 4.3pF | ±0.1pF | GQM1875C2E4R3BB12# |
| | | | | ±0.25pF | GQM1875C2E4R3CB12# |
| | | | 4.7pF | ±0.1pF | GQM1875C2E4R7BB12# |
| | | | | ±0.25pF | GQM1875C2E4R7CB12# |
| 5.0pF | ±0.1pF | GQM1875C2E5R0BB12# | | | |
| | ±0.25pF | GQM1875C2E5R0CB12# | | | |
| 5.1pF | ±0.25pF | GQM1875C2E5R1CB12# | | | |
| | ±0.5pF | GQM1875C2E5R1DB12# | | | |
| 5.6pF | ±0.25pF | GQM1875C2E5R6CB12# | | | |
| | ±0.5pF | GQM1875C2E5R6DB12# | | | |

| T max. | Rated Voltage | TC Code | Cap. | Tol. | Part Number |
|--------|---------------|--------------------|-------|---------|--------------------|
| 0.8mm | 250Vdc | C0G | 6.0pF | ±0.25pF | GQM1875C2E6R0CB12# |
| | | | | ±0.5pF | GQM1875C2E6R0DB12# |
| | | | 6.2pF | ±0.25pF | GQM1875C2E6R2CB12# |
| | | | | ±0.5pF | GQM1875C2E6R2DB12# |
| | | | 6.8pF | ±0.25pF | GQM1875C2E6R8CB12# |
| | | | | ±0.5pF | GQM1875C2E6R8DB12# |
| | | | 7.0pF | ±0.25pF | GQM1875C2E7R0CB12# |
| | | | | ±0.5pF | GQM1875C2E7R0DB12# |
| | | | 7.5pF | ±0.25pF | GQM1875C2E7R5CB12# |
| | | | | ±0.5pF | GQM1875C2E7R5DB12# |
| | | | 8.0pF | ±0.25pF | GQM1875C2E8R0CB12# |
| | | | | ±0.5pF | GQM1875C2E8R0DB12# |
| | | | 8.2pF | ±0.25pF | GQM1875C2E8R2CB12# |
| | | | | ±0.5pF | GQM1875C2E8R2DB12# |
| | | | 9.0pF | ±0.25pF | GQM1875C2E9R0CB12# |
| | | | | ±0.5pF | GQM1875C2E9R0DB12# |
| | | | 9.1pF | ±0.25pF | GQM1875C2E9R1CB12# |
| | | | | ±0.5pF | GQM1875C2E9R1DB12# |
| | | | 10pF | ±2% | GQM1875C2E100GB12# |
| | | | | ±5% | GQM1875C2E100JB12# |
| | | | 11pF | ±2% | GQM1875C2E110GB12# |
| | | | | ±5% | GQM1875C2E110JB12# |
| | | | 12pF | ±2% | GQM1875C2E120GB12# |
| | | | | ±5% | GQM1875C2E120JB12# |
| | | | 13pF | ±2% | GQM1875C2E130GB12# |
| | | | | ±5% | GQM1875C2E130JB12# |
| | | | 15pF | ±2% | GQM1875C2E150GB12# |
| | | | | ±5% | GQM1875C2E150JB12# |
| | | | 16pF | ±2% | GQM1875C2E160GB12# |
| | | | | ±5% | GQM1875C2E160JB12# |
| | | | 18pF | ±2% | GQM1875C2E180GB12# |
| | | | | ±5% | GQM1875C2E180JB12# |
| | | | 20pF | ±2% | GQM1875C2E200GB12# |
| | | | | ±5% | GQM1875C2E200JB12# |
| | | | 22pF | ±2% | GQM1875C2E220GB12# |
| | | | | ±5% | GQM1875C2E220JB12# |
| | | | 24pF | ±2% | GQM1875C2E240GB12# |
| | | | | ±5% | GQM1875C2E240JB12# |
| | | | 27pF | ±2% | GQM1875C2E270GB12# |
| | | | | ±5% | GQM1875C2E270JB12# |
| | | | 30pF | ±2% | GQM1875C2E300GB12# |
| | | | | ±5% | GQM1875C2E300JB12# |
| | | | 33pF | ±2% | GQM1875C2E330GB12# |
| | | | | ±5% | GQM1875C2E330JB12# |
| | | | 36pF | ±2% | GQM1875C2E360GB12# |
| | | | | ±5% | GQM1875C2E360JB12# |
| | | | 39pF | ±2% | GQM1875C2E390GB12# |
| | | | | ±5% | GQM1875C2E390JB12# |
| 43pF | ±2% | GQM1875C2E430GB12# | | | |
| | ±5% | GQM1875C2E430JB12# | | | |
| 47pF | ±2% | GQM1875C2E470GB12# | | | |
| | ±5% | GQM1875C2E470JB12# | | | |
| 0.9mm | 100Vdc | C0G | 0.5pF | ±0.1pF | GQM1885C2AR50BB01# |
| | | | | ±0.25pF | GQM1885C2AR50CB01# |

Part number # indicates the package specification code.

For General Purpose GRM Series

Capacitor Array GNM Series

Low ESL LL□ Series

High-Q Type GJM Series

High Frequency GQM Series

Monolithic Microchip GMA Series

For Bonding GMD Series

Product Information

GQM Series Temperature Compensating Type HiQ Part Number List

(→ ■ 1.6x0.8mm)

| T max. | Rated Voltage | TC Code | Cap. | Tol. | Part Number | | |
|--------|---------------|---------|--------|---------|--------------------|--------------------|--------------------|
| 0.9mm | 100Vdc | C0G | 0.75pF | ±0.1pF | GQM1885C2AR75BB01# | | |
| | | | | ±0.25pF | GQM1885C2AR75CB01# | | |
| | | | 1.0pF | ±0.1pF | GQM1885C2A1R0BB01# | | |
| | | | | ±0.25pF | GQM1885C2A1R0CB01# | | |
| | | | 1.1pF | ±0.1pF | GQM1885C2A1R1BB01# | | |
| | | | | ±0.25pF | GQM1885C2A1R1CB01# | | |
| | | | 1.2pF | ±0.1pF | GQM1885C2A1R2BB01# | | |
| | | | | ±0.25pF | GQM1885C2A1R2CB01# | | |
| | | | 1.3pF | ±0.1pF | GQM1885C2A1R3BB01# | | |
| | | | | ±0.25pF | GQM1885C2A1R3CB01# | | |
| | | | 1.5pF | ±0.1pF | GQM1885C2A1R5BB01# | | |
| | | | | ±0.25pF | GQM1885C2A1R5CB01# | | |
| | | | 1.6pF | ±0.1pF | GQM1885C2A1R6BB01# | | |
| | | | | ±0.25pF | GQM1885C2A1R6CB01# | | |
| | | | 1.8pF | ±0.1pF | GQM1885C2A1R8BB01# | | |
| | | | | ±0.25pF | GQM1885C2A1R8CB01# | | |
| | | | 2.0pF | ±0.1pF | GQM1885C2A2R0BB01# | | |
| | | | | ±0.25pF | GQM1885C2A2R0CB01# | | |
| | | | 2.2pF | ±0.1pF | GQM1885C2A2R2BB01# | | |
| | | | | ±0.25pF | GQM1885C2A2R2CB01# | | |
| | | | 2.4pF | ±0.1pF | GQM1885C2A2R4BB01# | | |
| | | | | ±0.25pF | GQM1885C2A2R4CB01# | | |
| | | | 2.7pF | ±0.1pF | GQM1885C2A2R7BB01# | | |
| | | | | ±0.25pF | GQM1885C2A2R7CB01# | | |
| | | | 3.0pF | ±0.1pF | GQM1885C2A3R0BB01# | | |
| | | | | ±0.25pF | GQM1885C2A3R0CB01# | | |
| | | | 3.3pF | ±0.1pF | GQM1885C2A3R3BB01# | | |
| | | | | ±0.25pF | GQM1885C2A3R3CB01# | | |
| | | | 3.6pF | ±0.1pF | GQM1885C2A3R6BB01# | | |
| | | | | ±0.25pF | GQM1885C2A3R6CB01# | | |
| | | | 3.9pF | ±0.1pF | GQM1885C2A3R9BB01# | | |
| | | | | ±0.25pF | GQM1885C2A3R9CB01# | | |
| | | | 4.0pF | ±0.1pF | GQM1885C2A4R0BB01# | | |
| | | | | ±0.25pF | GQM1885C2A4R0CB01# | | |
| | | | 4.3pF | ±0.1pF | GQM1885C2A4R3BB01# | | |
| | | | | ±0.25pF | GQM1885C2A4R3CB01# | | |
| | | | 4.7pF | ±0.1pF | GQM1885C2A4R7BB01# | | |
| | | | | ±0.25pF | GQM1885C2A4R7CB01# | | |
| | | | 5.0pF | ±0.1pF | GQM1885C2A5R0BB01# | | |
| | | | | ±0.25pF | GQM1885C2A5R0CB01# | | |
| | | | 5.1pF | ±0.25pF | GQM1885C2A5R1CB01# | | |
| | | | | ±0.5pF | GQM1885C2A5R1DB01# | | |
| | | | 5.6pF | ±0.25pF | GQM1885C2A5R6CB01# | | |
| | | | | ±0.5pF | GQM1885C2A5R6DB01# | | |
| | | | 6.0pF | ±0.25pF | GQM1885C2A6R0CB01# | | |
| | | | | ±0.5pF | GQM1885C2A6R0DB01# | | |
| | | | 6.2pF | ±0.25pF | GQM1885C2A6R2CB01# | | |
| | | | | ±0.5pF | GQM1885C2A6R2DB01# | | |
| | | | 6.8pF | ±0.25pF | GQM1885C2A6R8CB01# | | |
| | | | | ±0.5pF | GQM1885C2A6R8DB01# | | |
| | | | CK | 0.5pF | ±0.1pF | GQM1884C2AR50BB01# | |
| | | | | | ±0.25pF | GQM1884C2AR50CB01# | |
| | | | | | 0.75pF | ±0.1pF | GQM1884C2AR75BB01# |
| | | | | | | ±0.25pF | GQM1884C2AR75CB01# |

| T max. | Rated Voltage | TC Code | Cap. | Tol. | Part Number | |
|--------|---------------|---------|---------|--------------------|--------------------|--------------------|
| 0.9mm | 100Vdc | CK | 1.0pF | ±0.1pF | GQM1884C2A1R0BB01# | |
| | | | | ±0.25pF | GQM1884C2A1R0CB01# | |
| | | | 1.1pF | ±0.1pF | GQM1884C2A1R1BB01# | |
| | | | | ±0.25pF | GQM1884C2A1R1CB01# | |
| | | | 1.2pF | ±0.1pF | GQM1884C2A1R2BB01# | |
| | | | | ±0.25pF | GQM1884C2A1R2CB01# | |
| | | | 1.3pF | ±0.1pF | GQM1884C2A1R3BB01# | |
| | | | | ±0.25pF | GQM1884C2A1R3CB01# | |
| | | | 1.5pF | ±0.1pF | GQM1884C2A1R5BB01# | |
| | | | | ±0.25pF | GQM1884C2A1R5CB01# | |
| | | | 1.6pF | ±0.1pF | GQM1884C2A1R6BB01# | |
| | | | | ±0.25pF | GQM1884C2A1R6CB01# | |
| | | | 1.8pF | ±0.1pF | GQM1884C2A1R8BB01# | |
| | | | | ±0.25pF | GQM1884C2A1R8CB01# | |
| | | | 2.0pF | ±0.1pF | GQM1884C2A2R0BB01# | |
| | | | | ±0.25pF | GQM1884C2A2R0CB01# | |
| | | | CJ | 2.2pF | ±0.1pF | GQM1883C2A2R2BB01# |
| | | | | | ±0.25pF | GQM1883C2A2R2CB01# |
| | | | 2.4pF | ±0.1pF | GQM1883C2A2R4BB01# | |
| | | | | ±0.25pF | GQM1883C2A2R4CB01# | |
| | | | 2.7pF | ±0.1pF | GQM1883C2A2R7BB01# | |
| | | | | ±0.25pF | GQM1883C2A2R7CB01# | |
| | | | 3.0pF | ±0.1pF | GQM1883C2A3R0BB01# | |
| | | | | ±0.25pF | GQM1883C2A3R0CB01# | |
| | | | 3.3pF | ±0.1pF | GQM1883C2A3R3BB01# | |
| | | | | ±0.25pF | GQM1883C2A3R3CB01# | |
| | | | 3.6pF | ±0.1pF | GQM1883C2A3R6BB01# | |
| | | | | ±0.25pF | GQM1883C2A3R6CB01# | |
| | | | 3.9pF | ±0.1pF | GQM1883C2A3R9BB01# | |
| | | | | ±0.25pF | GQM1883C2A3R9CB01# | |
| | | | CH | 4.0pF | ±0.1pF | GQM1882C2A4R0BB01# |
| | | | | | ±0.25pF | GQM1882C2A4R0CB01# |
| | | | 4.3pF | ±0.1pF | GQM1882C2A4R3BB01# | |
| | | | | ±0.25pF | GQM1882C2A4R3CB01# | |
| | | | 4.7pF | ±0.1pF | GQM1882C2A4R7BB01# | |
| | | | | ±0.25pF | GQM1882C2A4R7CB01# | |
| | | 5.0pF | ±0.1pF | GQM1882C2A5R0BB01# | | |
| | | | ±0.25pF | GQM1882C2A5R0CB01# | | |
| | | 5.1pF | ±0.25pF | GQM1882C2A5R1CB01# | | |
| | | | ±0.5pF | GQM1882C2A5R1DB01# | | |
| | | 5.6pF | ±0.25pF | GQM1882C2A5R6CB01# | | |
| | | | ±0.5pF | GQM1882C2A5R6DB01# | | |
| | | 6.0pF | ±0.25pF | GQM1882C2A6R0CB01# | | |
| | | | ±0.5pF | GQM1882C2A6R0DB01# | | |
| | | 6.2pF | ±0.25pF | GQM1882C2A6R2CB01# | | |
| | | | ±0.5pF | GQM1882C2A6R2DB01# | | |
| | | 6.8pF | ±0.25pF | GQM1882C2A6R8CB01# | | |
| | | | ±0.5pF | GQM1882C2A6R8DB01# | | |
| | | 50Vdc | C0G | 7.0pF | ±0.25pF | GQM1885C1H7R0CB01# |
| | | | | | ±0.5pF | GQM1885C1H7R0DB01# |
| | | | | 7.5pF | ±0.25pF | GQM1885C1H7R5CB01# |
| | | | | | ±0.5pF | GQM1885C1H7R5DB01# |
| | | 8.0pF | ±0.25pF | GQM1885C1H8R0CB01# | | |
| | | | ±0.5pF | GQM1885C1H8R0DB01# | | |

Part number # indicates the package specification code.

For General Purpose GRM Series

Capacitor Array GNM Series

Low ESL LL Series

High-Q Type GJM Series

High Frequency GQM Series

Monolithic Microchip GMA Series

For Bonding GMD Series

Product Information

GQM Series Temperature Compensating Type HiQ Part Number List

(→ ■ 1.6x0.8mm)

| T max. | Rated Voltage | TC Code | Cap. | Tol. | Part Number |
|--------|---------------|---------|-------|---------|--------------------|
| 0.9mm | 50Vdc | C0G | 8.2pF | ±0.25pF | GQM1885C1H8R2CB01# |
| | | | | ±0.5pF | GQM1885C1H8R2DB01# |
| | | | 9.0pF | ±0.25pF | GQM1885C1H9R0CB01# |
| | | | | ±0.5pF | GQM1885C1H9R0DB01# |
| | | | 9.1pF | ±0.25pF | GQM1885C1H9R1CB01# |
| | | | | ±0.5pF | GQM1885C1H9R1DB01# |
| | | | 10pF | ±2% | GQM1885C1H100GB01# |
| | | | | ±5% | GQM1885C1H100JB01# |
| | | | 11pF | ±2% | GQM1885C1H110GB01# |
| | | | | ±5% | GQM1885C1H110JB01# |
| | | | 12pF | ±2% | GQM1885C1H120GB01# |
| | | | | ±5% | GQM1885C1H120JB01# |
| | | | 13pF | ±2% | GQM1885C1H130GB01# |
| | | | | ±5% | GQM1885C1H130JB01# |
| | | | 15pF | ±2% | GQM1885C1H150GB01# |
| | | | | ±5% | GQM1885C1H150JB01# |
| | | | 16pF | ±2% | GQM1885C1H160GB01# |
| | | | | ±5% | GQM1885C1H160JB01# |
| | | | 18pF | ±2% | GQM1885C1H180GB01# |
| | | | | ±5% | GQM1885C1H180JB01# |
| | | | 20pF | ±2% | GQM1885C1H200GB01# |
| | | | | ±5% | GQM1885C1H200JB01# |
| | | | 22pF | ±2% | GQM1885C1H220GB01# |
| | | | | ±5% | GQM1885C1H220JB01# |
| | | | 24pF | ±2% | GQM1885C1H240GB01# |
| | | | | ±5% | GQM1885C1H240JB01# |
| | | | 27pF | ±2% | GQM1885C1H270GB01# |
| | | | | ±5% | GQM1885C1H270JB01# |
| | | | 30pF | ±2% | GQM1885C1H300GB01# |
| | | | | ±5% | GQM1885C1H300JB01# |
| | | | 33pF | ±2% | GQM1885C1H330GB01# |
| | | | | ±5% | GQM1885C1H330JB01# |
| | | | 36pF | ±2% | GQM1885C1H360GB01# |
| | | | | ±5% | GQM1885C1H360JB01# |
| | | | 39pF | ±2% | GQM1885C1H390GB01# |
| | | | | ±5% | GQM1885C1H390JB01# |
| | | | 43pF | ±2% | GQM1885C1H430GB01# |
| | | | | ±5% | GQM1885C1H430JB01# |
| | | | 47pF | ±2% | GQM1885C1H470GB01# |
| | | | | ±5% | GQM1885C1H470JB01# |
| | | | 51pF | ±2% | GQM1885C1H510GB01# |
| | | | | ±5% | GQM1885C1H510JB01# |
| | | | 56pF | ±2% | GQM1885C1H560GB01# |
| | | | | ±5% | GQM1885C1H560JB01# |
| | | | 62pF | ±2% | GQM1885C1H620GB01# |
| | | | | ±5% | GQM1885C1H620JB01# |
| | | | 68pF | ±2% | GQM1885C1H680GB01# |
| | | | | ±5% | GQM1885C1H680JB01# |
| | | | 75pF | ±2% | GQM1885C1H750GB01# |
| | | | | ±5% | GQM1885C1H750JB01# |
| | | | 82pF | ±2% | GQM1885C1H820GB01# |
| | | | | ±5% | GQM1885C1H820JB01# |
| | | | 91pF | ±2% | GQM1885C1H910GB01# |
| | | | | ±5% | GQM1885C1H910JB01# |

| T max. | Rated Voltage | TC Code | Cap. | Tol. | Part Number |
|--------|---------------|--------------------|---------|--------------------|--------------------|
| 0.9mm | 50Vdc | C0G | 100pF | ±2% | GQM1885C1H101GB01# |
| | | | | ±5% | GQM1885C1H101JB01# |
| | | CH | 7.0pF | ±0.25pF | GQM1882C1H7R0CB01# |
| | | | | ±0.5pF | GQM1882C1H7R0DB01# |
| | | 7.5pF | ±0.25pF | GQM1882C1H7R5CB01# | |
| | | | ±0.5pF | GQM1882C1H7R5DB01# | |
| | | 8.0pF | ±0.25pF | GQM1882C1H8R0CB01# | |
| | | | ±0.5pF | GQM1882C1H8R0DB01# | |
| | | 8.2pF | ±0.25pF | GQM1882C1H8R2CB01# | |
| | | | ±0.5pF | GQM1882C1H8R2DB01# | |
| | | 9.0pF | ±0.25pF | GQM1882C1H9R0CB01# | |
| | | | ±0.5pF | GQM1882C1H9R0DB01# | |
| | | 9.1pF | ±0.25pF | GQM1882C1H9R1CB01# | |
| | | | ±0.5pF | GQM1882C1H9R1DB01# | |
| | | 10pF | ±2% | GQM1882C1H100GB01# | |
| | | | ±5% | GQM1882C1H100JB01# | |
| | | 11pF | ±2% | GQM1882C1H110GB01# | |
| | | | ±5% | GQM1882C1H110JB01# | |
| | | 12pF | ±2% | GQM1882C1H120GB01# | |
| | | | ±5% | GQM1882C1H120JB01# | |
| | | 13pF | ±2% | GQM1882C1H130GB01# | |
| | | | ±5% | GQM1882C1H130JB01# | |
| | | 15pF | ±2% | GQM1882C1H150GB01# | |
| | | | ±5% | GQM1882C1H150JB01# | |
| | | 16pF | ±2% | GQM1882C1H160GB01# | |
| | | | ±5% | GQM1882C1H160JB01# | |
| | | 18pF | ±2% | GQM1882C1H180GB01# | |
| | | | ±5% | GQM1882C1H180JB01# | |
| | | 20pF | ±2% | GQM1882C1H200GB01# | |
| | | | ±5% | GQM1882C1H200JB01# | |
| | | 22pF | ±2% | GQM1882C1H220GB01# | |
| | | | ±5% | GQM1882C1H220JB01# | |
| | | 24pF | ±2% | GQM1882C1H240GB01# | |
| | | | ±5% | GQM1882C1H240JB01# | |
| | | 27pF | ±2% | GQM1882C1H270GB01# | |
| | | | ±5% | GQM1882C1H270JB01# | |
| | | 30pF | ±2% | GQM1882C1H300GB01# | |
| | | | ±5% | GQM1882C1H300JB01# | |
| | | 33pF | ±2% | GQM1882C1H330GB01# | |
| | | | ±5% | GQM1882C1H330JB01# | |
| | | 36pF | ±2% | GQM1882C1H360GB01# | |
| | | | ±5% | GQM1882C1H360JB01# | |
| 39pF | ±2% | GQM1882C1H390GB01# | | | |
| | ±5% | GQM1882C1H390JB01# | | | |
| 43pF | ±2% | GQM1882C1H430GB01# | | | |
| | ±5% | GQM1882C1H430JB01# | | | |
| 47pF | ±2% | GQM1882C1H470GB01# | | | |
| | ±5% | GQM1882C1H470JB01# | | | |
| 51pF | ±2% | GQM1882C1H510GB01# | | | |
| | ±5% | GQM1882C1H510JB01# | | | |
| 56pF | ±2% | GQM1882C1H560GB01# | | | |
| | ±5% | GQM1882C1H560JB01# | | | |
| 62pF | ±2% | GQM1882C1H620GB01# | | | |
| | ±5% | GQM1882C1H620JB01# | | | |
| 68pF | ±2% | GQM1882C1H680GB01# | | | |
| | ±5% | GQM1882C1H680JB01# | | | |
| 75pF | ±2% | GQM1882C1H750GB01# | | | |
| | ±5% | GQM1882C1H750JB01# | | | |
| 82pF | ±2% | GQM1882C1H820GB01# | | | |
| | ±5% | GQM1882C1H820JB01# | | | |

For General Purpose GRM Series

Capacitor Array GNM Series

Low ESL LLQ Series

High-Q Type GJM Series

High Frequency GQM Series

Monolithic Microchip GMA Series

For Bonding GMD Series

Product Information

Part number # indicates the package specification code.

GQM Series Temperature Compensating Type HiQ Part Number List

(→ ■ 1.6x0.8mm)

| T max. | Rated Voltage | TC Code | Cap. | Tol. | Part Number |
|--------|---------------|---------|-------|------|--------------------|
| 0.9mm | 50Vdc | CH | 68pF | ±2% | GQM1882C1H680GB01# |
| | | | | ±5% | GQM1882C1H680JB01# |
| | | | 75pF | ±2% | GQM1882C1H750GB01# |
| | | | | ±5% | GQM1882C1H750JB01# |
| | | | 82pF | ±2% | GQM1882C1H820GB01# |
| | | | | ±5% | GQM1882C1H820JB01# |
| | | | 91pF | ±2% | GQM1882C1H910GB01# |
| | | | | ±5% | GQM1882C1H910JB01# |
| | | | 100pF | ±2% | GQM1882C1H101GB01# |
| | | | | ±5% | GQM1882C1H101JB01# |

| T max. | Rated Voltage | TC Code | Cap. | Tol. | Part Number | | | |
|--------|---------------|--------------------|-------|---------|--------------------|--------|---------|--------------------|
| 0.95mm | 100Vdc | C0G | 4.7pF | ±0.25pF | GQM2195C2A4R7CB01# | | | |
| | | | | ±0.1pF | GQM2195C2A5R0BB01# | | | |
| | | | 5.0pF | ±0.25pF | GQM2195C2A5R0CB01# | | | |
| | | | | ±0.1pF | GQM2195C2A5R1CB01# | | | |
| | | | 5.1pF | ±0.25pF | GQM2195C2A5R1CB01# | | | |
| | | | | ±0.5pF | GQM2195C2A5R1DB01# | | | |
| | | | 5.6pF | ±0.25pF | GQM2195C2A5R6CB01# | | | |
| | | | | ±0.5pF | GQM2195C2A5R6DB01# | | | |
| | | | 6.0pF | ±0.25pF | GQM2195C2A6R0CB01# | | | |
| | | | | ±0.5pF | GQM2195C2A6R0DB01# | | | |
| | | | 6.2pF | ±0.25pF | GQM2195C2A6R2CB01# | | | |
| | | | | ±0.5pF | GQM2195C2A6R2DB01# | | | |
| | | | 6.8pF | ±0.25pF | GQM2195C2A6R8CB01# | | | |
| | | | | ±0.5pF | GQM2195C2A6R8DB01# | | | |
| | | | 7.0pF | ±0.25pF | GQM2195C2A7R0CB01# | | | |
| | | | | ±0.5pF | GQM2195C2A7R0DB01# | | | |
| | | | 7.5pF | ±0.25pF | GQM2195C2A7R5CB01# | | | |
| | | | | ±0.5pF | GQM2195C2A7R5DB01# | | | |
| | | | 8.0pF | ±0.25pF | GQM2195C2A8R0CB01# | | | |
| | | | | ±0.5pF | GQM2195C2A8R0DB01# | | | |
| | | | 8.2pF | ±0.25pF | GQM2195C2A8R2CB01# | | | |
| | | | | ±0.5pF | GQM2195C2A8R2DB01# | | | |
| | | | 9.0pF | ±0.25pF | GQM2195C2A9R0CB01# | | | |
| | | | | ±0.5pF | GQM2195C2A9R0DB01# | | | |
| | | | 9.1pF | ±0.25pF | GQM2195C2A9R1CB01# | | | |
| | | | | ±0.5pF | GQM2195C2A9R1DB01# | | | |
| | | | 10pF | ±2% | GQM2195C2A100GB01# | | | |
| | | | | ±5% | GQM2195C2A100JB01# | | | |
| | | | 11pF | ±2% | GQM2195C2A110GB01# | | | |
| | | | | ±5% | GQM2195C2A110JB01# | | | |
| | | | 12pF | ±2% | GQM2195C2A120GB01# | | | |
| | | | | ±5% | GQM2195C2A120JB01# | | | |
| | | | 13pF | ±2% | GQM2195C2A130GB01# | | | |
| | | | | ±5% | GQM2195C2A130JB01# | | | |
| | | | 15pF | ±2% | GQM2195C2A150GB01# | | | |
| | | | | ±5% | GQM2195C2A150JB01# | | | |
| | | | 16pF | ±2% | GQM2195C2A160GB01# | | | |
| | | | | ±5% | GQM2195C2A160JB01# | | | |
| | | | 18pF | ±2% | GQM2195C2A180GB01# | | | |
| | | | | ±5% | GQM2195C2A180JB01# | | | |
| | | | CK | | | 0.5pF | ±0.1pF | GQM2194C2AR50BB01# |
| | | | | | | | ±0.25pF | GQM2194C2AR50CB01# |
| | | | | | | 0.75pF | ±0.1pF | GQM2194C2AR75BB01# |
| | | | | | | | ±0.25pF | GQM2194C2AR75CB01# |
| | | | | | | 1.0pF | ±0.1pF | GQM2194C2A1R0BB01# |
| | | | | | | | ±0.25pF | GQM2194C2A1R0CB01# |
| | | | | | | 1.1pF | ±0.1pF | GQM2194C2A1R1BB01# |
| | | | | | | | ±0.25pF | GQM2194C2A1R1CB01# |
| 1.2pF | ±0.1pF | GQM2194C2A1R2BB01# | | | | | | |
| | ±0.25pF | GQM2194C2A1R2CB01# | | | | | | |
| 1.3pF | ±0.1pF | GQM2194C2A1R3BB01# | | | | | | |
| | ±0.25pF | GQM2194C2A1R3CB01# | | | | | | |
| 1.5pF | ±0.1pF | GQM2194C2A1R5BB01# | | | | | | |
| | ±0.25pF | GQM2194C2A1R5CB01# | | | | | | |
| 1.6pF | ±0.1pF | GQM2194C2A1R6BB01# | | | | | | |
| | ±0.25pF | GQM2194C2A1R6CB01# | | | | | | |
| 1.8pF | ±0.1pF | GQM2194C2A1R8BB01# | | | | | | |
| | ±0.25pF | GQM2194C2A1R8CB01# | | | | | | |
| 2.0pF | ±0.1pF | GQM2194C2A2R0BB01# | | | | | | |
| | ±0.25pF | GQM2194C2A2R0CB01# | | | | | | |
| 2.2pF | ±0.1pF | GQM2194C2A2R2BB01# | | | | | | |
| | ±0.25pF | GQM2194C2A2R2CB01# | | | | | | |
| 2.4pF | ±0.1pF | GQM2194C2A2R4BB01# | | | | | | |
| | ±0.25pF | GQM2194C2A2R4CB01# | | | | | | |
| 2.7pF | ±0.1pF | GQM2194C2A2R7BB01# | | | | | | |
| | ±0.25pF | GQM2194C2A2R7CB01# | | | | | | |
| 3.0pF | ±0.1pF | GQM2194C2A3R0BB01# | | | | | | |
| | ±0.25pF | GQM2194C2A3R0CB01# | | | | | | |
| 3.3pF | ±0.1pF | GQM2194C2A3R3BB01# | | | | | | |
| | ±0.25pF | GQM2194C2A3R3CB01# | | | | | | |
| 3.6pF | ±0.1pF | GQM2194C2A3R6BB01# | | | | | | |
| | ±0.25pF | GQM2194C2A3R6CB01# | | | | | | |
| 3.9pF | ±0.1pF | GQM2194C2A3R9BB01# | | | | | | |
| | ±0.25pF | GQM2194C2A3R9CB01# | | | | | | |
| 4.0pF | ±0.1pF | GQM2194C2A4R0BB01# | | | | | | |
| | ±0.25pF | GQM2194C2A4R0CB01# | | | | | | |
| 4.3pF | ±0.1pF | GQM2194C2A4R3BB01# | | | | | | |
| | ±0.25pF | GQM2194C2A4R3CB01# | | | | | | |
| 4.7pF | ±0.1pF | GQM2194C2A4R7BB01# | | | | | | |

■ 2.0x1.25mm

| T max. | Rated Voltage | TC Code | Cap. | Tol. | Part Number |
|--------|---------------|---------|--------|---------|--------------------|
| 0.95mm | 100Vdc | C0G | 0.5pF | ±0.1pF | GQM2195C2AR50BB01# |
| | | | | ±0.25pF | GQM2195C2AR50CB01# |
| | | | 0.75pF | ±0.1pF | GQM2195C2AR75BB01# |
| | | | | ±0.25pF | GQM2195C2AR75CB01# |
| | | | 1.0pF | ±0.1pF | GQM2195C2A1R0BB01# |
| | | | | ±0.25pF | GQM2195C2A1R0CB01# |
| | | | 1.1pF | ±0.1pF | GQM2195C2A1R1BB01# |
| | | | | ±0.25pF | GQM2195C2A1R1CB01# |
| | | | 1.2pF | ±0.1pF | GQM2195C2A1R2BB01# |
| | | | | ±0.25pF | GQM2195C2A1R2CB01# |
| | | | 1.3pF | ±0.1pF | GQM2195C2A1R3BB01# |
| | | | | ±0.25pF | GQM2195C2A1R3CB01# |
| | | | 1.5pF | ±0.1pF | GQM2195C2A1R5BB01# |
| | | | | ±0.25pF | GQM2195C2A1R5CB01# |
| | | | 1.6pF | ±0.1pF | GQM2195C2A1R6BB01# |
| | | | | ±0.25pF | GQM2195C2A1R6CB01# |
| | | | 1.8pF | ±0.1pF | GQM2195C2A1R8BB01# |
| | | | | ±0.25pF | GQM2195C2A1R8CB01# |
| | | | 2.0pF | ±0.1pF | GQM2195C2A2R0BB01# |
| | | | | ±0.25pF | GQM2195C2A2R0CB01# |
| | | | 2.2pF | ±0.1pF | GQM2195C2A2R2BB01# |
| | | | | ±0.25pF | GQM2195C2A2R2CB01# |
| | | | 2.4pF | ±0.1pF | GQM2195C2A2R4BB01# |
| | | | | ±0.25pF | GQM2195C2A2R4CB01# |
| | | | 2.7pF | ±0.1pF | GQM2195C2A2R7BB01# |
| | | | | ±0.25pF | GQM2195C2A2R7CB01# |
| | | | 3.0pF | ±0.1pF | GQM2195C2A3R0BB01# |
| | | | | ±0.25pF | GQM2195C2A3R0CB01# |
| | | | 3.3pF | ±0.1pF | GQM2195C2A3R3BB01# |
| | | | | ±0.25pF | GQM2195C2A3R3CB01# |
| | | | 3.6pF | ±0.1pF | GQM2195C2A3R6BB01# |
| | | | | ±0.25pF | GQM2195C2A3R6CB01# |
| | | | 3.9pF | ±0.1pF | GQM2195C2A3R9BB01# |
| | | | | ±0.25pF | GQM2195C2A3R9CB01# |
| | | | 4.0pF | ±0.1pF | GQM2195C2A4R0BB01# |
| | | | | ±0.25pF | GQM2195C2A4R0CB01# |
| | | | 4.3pF | ±0.1pF | GQM2195C2A4R3BB01# |
| | | | | ±0.25pF | GQM2195C2A4R3CB01# |
| | | | 4.7pF | ±0.1pF | GQM2195C2A4R7BB01# |

Part number # indicates the package specification code.

For General Purpose GRM Series
 Capacitor Array GNM Series
 Low ESL LLD Series
 High-Q Type GJM Series
 High Frequency GQM Series
 Monolithic Microchip GMA Series
 For Bonding GMD Series
 Product Information

GQM Series Temperature Compensating Type HiQ Part Number List

(→ ■ 2.0x1.25mm)

| T max. | Rated Voltage | TC Code | Cap. | Tol. | Part Number | |
|--------|---------------|---------|---------|--------------------|--------------------|--------------------|
| 0.95mm | 100Vdc | CK | 1.6pF | ±0.25pF | GQM2194C2A1R6CB01# | |
| | | | | ±0.1pF | GQM2194C2A1R8BB01# | |
| | | | 1.8pF | ±0.25pF | GQM2194C2A1R8CB01# | |
| | | | | ±0.1pF | GQM2194C2A2R0BB01# | |
| | | | 2.0pF | ±0.25pF | GQM2194C2A2R0CB01# | |
| | | | | CJ | 2.2pF | ±0.1pF |
| | | | ±0.25pF | | | GQM2193C2A2R2CB01# |
| | | | 2.4pF | | ±0.1pF | GQM2193C2A2R4BB01# |
| | | | | | ±0.25pF | GQM2193C2A2R4CB01# |
| | | | 2.7pF | ±0.1pF | GQM2193C2A2R7BB01# | |
| | | ±0.25pF | | GQM2193C2A2R7CB01# | | |
| | | 3.0pF | ±0.1pF | GQM2193C2A3R0BB01# | | |
| | | | ±0.25pF | GQM2193C2A3R0CB01# | | |
| | | 3.3pF | ±0.1pF | GQM2193C2A3R3BB01# | | |
| | | | ±0.25pF | GQM2193C2A3R3CB01# | | |
| | | 3.6pF | ±0.1pF | GQM2193C2A3R6BB01# | | |
| | | | ±0.25pF | GQM2193C2A3R6CB01# | | |
| | | 3.9pF | ±0.1pF | GQM2193C2A3R9BB01# | | |
| | | | ±0.25pF | GQM2193C2A3R9CB01# | | |
| | | CH | 4.0pF | ±0.1pF | GQM2192C2A4R0BB01# | |
| | | | | ±0.25pF | GQM2192C2A4R0CB01# | |
| | | | 4.3pF | ±0.1pF | GQM2192C2A4R3BB01# | |
| | | | | ±0.25pF | GQM2192C2A4R3CB01# | |
| | | | 4.7pF | ±0.1pF | GQM2192C2A4R7BB01# | |
| | | | | ±0.25pF | GQM2192C2A4R7CB01# | |
| | | | 5.0pF | ±0.1pF | GQM2192C2A5R0BB01# | |
| | | | | ±0.25pF | GQM2192C2A5R0CB01# | |
| | | | 5.1pF | ±0.25pF | GQM2192C2A5R1CB01# | |
| | | | | ±0.5pF | GQM2192C2A5R1DB01# | |
| | | | 5.6pF | ±0.25pF | GQM2192C2A5R6CB01# | |
| | | | | ±0.5pF | GQM2192C2A5R6DB01# | |
| | | | 6.0pF | ±0.25pF | GQM2192C2A6R0CB01# | |
| | | | | ±0.5pF | GQM2192C2A6R0DB01# | |
| | | | 6.2pF | ±0.25pF | GQM2192C2A6R2CB01# | |
| | | | | ±0.5pF | GQM2192C2A6R2DB01# | |
| | | | 6.8pF | ±0.25pF | GQM2192C2A6R8CB01# | |
| | | | | ±0.5pF | GQM2192C2A6R8DB01# | |
| | | | 7.0pF | ±0.25pF | GQM2192C2A7R0CB01# | |
| | | | | ±0.5pF | GQM2192C2A7R0DB01# | |
| | | | 7.5pF | ±0.25pF | GQM2192C2A7R5CB01# | |
| | | | | ±0.5pF | GQM2192C2A7R5DB01# | |
| | | | 8.0pF | ±0.25pF | GQM2192C2A8R0CB01# | |
| | | | | ±0.5pF | GQM2192C2A8R0DB01# | |
| | | | 8.2pF | ±0.25pF | GQM2192C2A8R2CB01# | |
| | | | | ±0.5pF | GQM2192C2A8R2DB01# | |
| | | | 9.0pF | ±0.25pF | GQM2192C2A9R0CB01# | |
| | | | | ±0.5pF | GQM2192C2A9R0DB01# | |
| | | | 9.1pF | ±0.25pF | GQM2192C2A9R1CB01# | |
| | | | | ±0.5pF | GQM2192C2A9R1DB01# | |
| | | 10pF | ±2% | GQM2192C2A100GB01# | | |
| | | | ±5% | GQM2192C2A100JB01# | | |
| | | 11pF | ±2% | GQM2192C2A110GB01# | | |
| | | | ±5% | GQM2192C2A110JB01# | | |
| | | 12pF | ±2% | GQM2192C2A120GB01# | | |

| T max. | Rated Voltage | TC Code | Cap. | Tol. | Part Number | | |
|--------|--------------------|--------------------|--------------------|--------------------|--------------------|--------------------|--------------------|
| 0.95mm | 100Vdc | CH | 12pF | ±5% | GQM2192C2A120JB01# | | |
| | | | | ±2% | GQM2192C2A130GB01# | | |
| | | | 13pF | ±5% | GQM2192C2A130JB01# | | |
| | | | | ±2% | GQM2192C2A150GB01# | | |
| | | | 15pF | ±5% | GQM2192C2A150JB01# | | |
| | | | | ±2% | GQM2192C2A160GB01# | | |
| | | | 16pF | ±5% | GQM2192C2A160JB01# | | |
| | | | | ±2% | GQM2192C2A180GB01# | | |
| | | | 18pF | ±5% | GQM2192C2A180JB01# | | |
| | | | | 50Vdc | C0G | 20pF | ±2% |
| | | | ±5% | | | | GQM2195C1H200JB01# |
| | | | 22pF | | | ±2% | GQM2195C1H220GB01# |
| | | | | | | ±5% | GQM2195C1H220JB01# |
| | | | 24pF | | | ±2% | GQM2195C1H240GB01# |
| | | | | | | ±5% | GQM2195C1H240JB01# |
| | | | 27pF | | | ±2% | GQM2195C1H270GB01# |
| | | | | | | ±5% | GQM2195C1H270JB01# |
| | | | 30pF | | | ±2% | GQM2195C1H300GB01# |
| | | ±5% | | | | GQM2195C1H300JB01# | |
| | | 33pF | ±2% | | | GQM2195C1H330GB01# | |
| | | | ±5% | | | GQM2195C1H330JB01# | |
| | | 36pF | ±2% | GQM2195C1H360GB01# | | | |
| | | | ±5% | GQM2195C1H360JB01# | | | |
| | | 39pF | ±2% | GQM2195C1H390GB01# | | | |
| | | | ±5% | GQM2195C1H390JB01# | | | |
| | | 43pF | ±2% | GQM2195C1H430GB01# | | | |
| | | | ±5% | GQM2195C1H430JB01# | | | |
| | | 47pF | ±2% | GQM2195C1H470GB01# | | | |
| | | | ±5% | GQM2195C1H470JB01# | | | |
| | | 51pF | ±2% | GQM2195C1H510GB01# | | | |
| ±5% | GQM2195C1H510JB01# | | | | | | |
| 56pF | ±2% | GQM2195C1H560GB01# | | | | | |
| | ±5% | GQM2195C1H560JB01# | | | | | |
| 62pF | ±2% | GQM2195C1H620GB01# | | | | | |
| | ±5% | GQM2195C1H620JB01# | | | | | |
| 68pF | ±2% | GQM2195C1H680GB01# | | | | | |
| | ±5% | GQM2195C1H680JB01# | | | | | |
| 75pF | ±2% | GQM2195C1H750GB01# | | | | | |
| | ±5% | GQM2195C1H750JB01# | | | | | |
| 82pF | ±2% | GQM2195C1H820GB01# | | | | | |
| | ±5% | GQM2195C1H820JB01# | | | | | |
| 91pF | ±2% | GQM2195C1H910GB01# | | | | | |
| | ±5% | GQM2195C1H910JB01# | | | | | |
| 100pF | ±2% | GQM2195C1H101GB01# | | | | | |
| | ±5% | GQM2195C1H101JB01# | | | | | |
| CH | 20pF | ±2% | GQM2192C1H200GB01# | | | | |
| | | ±5% | GQM2192C1H200JB01# | | | | |
| | 22pF | ±2% | GQM2192C1H220GB01# | | | | |
| | | ±5% | GQM2192C1H220JB01# | | | | |
| | 24pF | ±2% | GQM2192C1H240GB01# | | | | |
| | | ±5% | GQM2192C1H240JB01# | | | | |
| 27pF | ±2% | GQM2192C1H270GB01# | | | | | |
| | ±5% | GQM2192C1H270JB01# | | | | | |
| 30pF | ±2% | GQM2192C1H300GB01# | | | | | |

For General Purpose GRM Series

Capacitor Array GNM Series

Low ESL LLL Series

High-Q Type GJM Series

High Frequency GQM Series

Monolithic Microchip GMA Series

For Bonding GMD Series

Product Information

Part number # indicates the package specification code.

GQM Series Temperature Compensating Type HiQ Part Number List

(→ ■ 2.0x1.25mm)

| T max. | Rated Voltage | TC Code | Cap. | Tol. | Part Number | | | |
|---------|--------------------|--------------------|-------|--------|--------------------|--------------------|---------|--------------------|
| 0.95mm | 50Vdc | CH | 30pF | ±5% | GQM2192C1H300JB01# | | | |
| | | | | ±2% | GQM2192C1H330GB01# | | | |
| | | | 33pF | ±5% | GQM2192C1H330JB01# | | | |
| | | | | 36pF | ±2% | GQM2192C1H360GB01# | | |
| | | | ±5% | | GQM2192C1H360JB01# | | | |
| | | | 39pF | ±2% | GQM2192C1H390GB01# | | | |
| | | | | ±5% | GQM2192C1H390JB01# | | | |
| | | | 43pF | ±2% | GQM2192C1H430GB01# | | | |
| | | | | ±5% | GQM2192C1H430JB01# | | | |
| | | | 47pF | ±2% | GQM2192C1H470GB01# | | | |
| | | | | ±5% | GQM2192C1H470JB01# | | | |
| | | | 51pF | ±2% | GQM2192C1H510GB01# | | | |
| | | | | ±5% | GQM2192C1H510JB01# | | | |
| | | | 56pF | ±2% | GQM2192C1H560GB01# | | | |
| | | | | ±5% | GQM2192C1H560JB01# | | | |
| | | | 62pF | ±2% | GQM2192C1H620GB01# | | | |
| | | | | ±5% | GQM2192C1H620JB01# | | | |
| | | | 68pF | ±2% | GQM2192C1H680GB01# | | | |
| | | | | ±5% | GQM2192C1H680JB01# | | | |
| | | | 75pF | ±2% | GQM2192C1H750GB01# | | | |
| | | | | ±5% | GQM2192C1H750JB01# | | | |
| | | | 82pF | ±2% | GQM2192C1H820GB01# | | | |
| | | | | ±5% | GQM2192C1H820JB01# | | | |
| | | | 91pF | ±2% | GQM2192C1H910GB01# | | | |
| | | | | ±5% | GQM2192C1H910JB01# | | | |
| | | | 100pF | ±2% | GQM2192C1H101GB01# | | | |
| | | | | ±5% | GQM2192C1H101JB01# | | | |
| | | | 1mm | 250Vdc | C0G | 0.5pF | ±0.1pF | GQM2195C2ER50BB12# |
| | | | | | | | ±0.25pF | GQM2195C2ER50CB12# |
| | | | | | | 0.75pF | ±0.1pF | GQM2195C2ER75BB12# |
| ±0.25pF | GQM2195C2ER75CB12# | | | | | | | |
| 1.0pF | ±0.1pF | GQM2195C2E1R0BB12# | | | | | | |
| | ±0.25pF | GQM2195C2E1R0CB12# | | | | | | |
| 1.1pF | ±0.1pF | GQM2195C2E1R1BB12# | | | | | | |
| | ±0.25pF | GQM2195C2E1R1CB12# | | | | | | |
| 1.2pF | ±0.1pF | GQM2195C2E1R2BB12# | | | | | | |
| | ±0.25pF | GQM2195C2E1R2CB12# | | | | | | |
| 1.3pF | ±0.1pF | GQM2195C2E1R3BB12# | | | | | | |
| | ±0.25pF | GQM2195C2E1R3CB12# | | | | | | |
| 1.5pF | ±0.1pF | GQM2195C2E1R5BB12# | | | | | | |
| | ±0.25pF | GQM2195C2E1R5CB12# | | | | | | |
| 1.6pF | ±0.1pF | GQM2195C2E1R6BB12# | | | | | | |
| | ±0.25pF | GQM2195C2E1R6CB12# | | | | | | |
| 1.8pF | ±0.1pF | GQM2195C2E1R8BB12# | | | | | | |
| | ±0.25pF | GQM2195C2E1R8CB12# | | | | | | |
| 2.0pF | ±0.1pF | GQM2195C2E2R0BB12# | | | | | | |
| | ±0.25pF | GQM2195C2E2R0CB12# | | | | | | |
| 2.2pF | ±0.1pF | GQM2195C2E2R2BB12# | | | | | | |
| | ±0.25pF | GQM2195C2E2R2CB12# | | | | | | |
| 2.4pF | ±0.1pF | GQM2195C2E2R4BB12# | | | | | | |
| | ±0.25pF | GQM2195C2E2R4CB12# | | | | | | |
| 2.7pF | ±0.1pF | GQM2195C2E2R7BB12# | | | | | | |
| | ±0.25pF | GQM2195C2E2R7CB12# | | | | | | |
| 3.0pF | ±0.1pF | GQM2195C2E3R0BB12# | | | | | | |

| T max. | Rated Voltage | TC Code | Cap. | Tol. | Part Number |
|--------|--------------------|--------------------|---------|---------|--------------------|
| 1mm | 250Vdc | C0G | 3.0pF | ±0.25pF | GQM2195C2E3R0CB12# |
| | | | | ±0.1pF | GQM2195C2E3R3BB12# |
| | | | 3.3pF | ±0.25pF | GQM2195C2E3R3CB12# |
| | | | | 3.6pF | ±0.1pF |
| | | | ±0.25pF | | GQM2195C2E3R6CB12# |
| | | | 3.9pF | ±0.1pF | GQM2195C2E3R9BB12# |
| | | | | ±0.25pF | GQM2195C2E3R9CB12# |
| | | | 4.0pF | ±0.1pF | GQM2195C2E4R0BB12# |
| | | | | ±0.25pF | GQM2195C2E4R0CB12# |
| | | | 4.3pF | ±0.1pF | GQM2195C2E4R3BB12# |
| | | | | ±0.25pF | GQM2195C2E4R3CB12# |
| | | | 4.7pF | ±0.1pF | GQM2195C2E4R7BB12# |
| | | | | ±0.25pF | GQM2195C2E4R7CB12# |
| | | | 5.0pF | ±0.1pF | GQM2195C2E5R0BB12# |
| | | | | ±0.25pF | GQM2195C2E5R0CB12# |
| | | | 5.1pF | ±0.25pF | GQM2195C2E5R1CB12# |
| | | | | ±0.5pF | GQM2195C2E5R1DB12# |
| | | | 5.6pF | ±0.25pF | GQM2195C2E5R6CB12# |
| | | | | ±0.5pF | GQM2195C2E5R6DB12# |
| | | | 6.0pF | ±0.25pF | GQM2195C2E6R0CB12# |
| | | | | ±0.5pF | GQM2195C2E6R0DB12# |
| | | | 6.2pF | ±0.25pF | GQM2195C2E6R2CB12# |
| | | | | ±0.5pF | GQM2195C2E6R2DB12# |
| | | | 6.8pF | ±0.25pF | GQM2195C2E6R8CB12# |
| | | | | ±0.5pF | GQM2195C2E6R8DB12# |
| | | | 7.0pF | ±0.25pF | GQM2195C2E7R0CB12# |
| | | | | ±0.5pF | GQM2195C2E7R0DB12# |
| | | | 7.5pF | ±0.25pF | GQM2195C2E7R5CB12# |
| | | | | ±0.5pF | GQM2195C2E7R5DB12# |
| | | | 8.0pF | ±0.25pF | GQM2195C2E8R0CB12# |
| ±0.5pF | GQM2195C2E8R0DB12# | | | | |
| 8.2pF | ±0.25pF | GQM2195C2E8R2CB12# | | | |
| | ±0.5pF | GQM2195C2E8R2DB12# | | | |
| 9.0pF | ±0.25pF | GQM2195C2E9R0CB12# | | | |
| | ±0.5pF | GQM2195C2E9R0DB12# | | | |
| 9.1pF | ±0.25pF | GQM2195C2E9R1CB12# | | | |
| | ±0.5pF | GQM2195C2E9R1DB12# | | | |
| 10pF | ±2% | GQM2195C2E100GB12# | | | |
| | ±5% | GQM2195C2E100JB12# | | | |
| 11pF | ±2% | GQM2195C2E110GB12# | | | |
| | ±5% | GQM2195C2E110JB12# | | | |
| 12pF | ±2% | GQM2195C2E120GB12# | | | |
| | ±5% | GQM2195C2E120JB12# | | | |
| 13pF | ±2% | GQM2195C2E130GB12# | | | |
| | ±5% | GQM2195C2E130JB12# | | | |
| 15pF | ±2% | GQM2195C2E150GB12# | | | |
| | ±5% | GQM2195C2E150JB12# | | | |
| 16pF | ±2% | GQM2195C2E160GB12# | | | |
| | ±5% | GQM2195C2E160JB12# | | | |
| 18pF | ±2% | GQM2195C2E180GB12# | | | |
| | ±5% | GQM2195C2E180JB12# | | | |
| 20pF | ±2% | GQM2195C2E200GB12# | | | |
| | ±5% | GQM2195C2E200JB12# | | | |
| 22pF | ±2% | GQM2195C2E220GB12# | | | |

Part number # indicates the package specification code.

For General Purpose GRM Series

Capacitor Array GNM Series

Low ESL LLI Series

High-Q Type GJM Series

High Frequency GQM Series

Monolithic Microchip GMA Series

For Bonding GMD Series

Product Information

GQM Series Temperature Compensating Type HiQ Part Number List

(→ ■ 2.0x1.25mm)

| T max. | Rated Voltage | TC Code | Cap. | Tol. | Part Number |
|--------|---------------|--------------------|------|------|--------------------|
| 1mm | 250Vdc | C0G | 22pF | ±5% | GQM2195C2E220JB12# |
| | | | | ±2% | GQM2195C2E240GB12# |
| | | | 24pF | ±5% | GQM2195C2E240JB12# |
| | | | | ±2% | GQM2195C2E270GB12# |
| | | | 27pF | ±5% | GQM2195C2E270JB12# |
| | | | | ±2% | GQM2195C2E300GB12# |
| | | | 30pF | ±5% | GQM2195C2E300JB12# |
| | | | | ±2% | GQM2195C2E330GB12# |
| | | | 33pF | ±5% | GQM2195C2E330JB12# |
| | | | | ±2% | GQM2195C2E360GB12# |
| | | | 36pF | ±5% | GQM2195C2E360JB12# |
| | | | | ±2% | GQM2195C2E390GB12# |
| | | | 39pF | ±5% | GQM2195C2E390JB12# |
| | | | | ±2% | GQM2195C2E430GB12# |
| | | | 43pF | ±5% | GQM2195C2E430JB12# |
| | | | | ±2% | GQM2195C2E470GB12# |
| | | | 47pF | ±5% | GQM2195C2E470JB12# |
| | | | | ±2% | GQM2195C2E510GB12# |
| | | | 51pF | ±5% | GQM2195C2E510JB12# |
| | | | | ±2% | GQM2195C2E560GB12# |
| | | | 56pF | ±5% | GQM2195C2E560JB12# |
| | | | | ±2% | GQM2195C2E620GB12# |
| | | | 62pF | ±5% | GQM2195C2E620JB12# |
| | | | | ±2% | GQM2195C2E680GB12# |
| | | | 68pF | ±5% | GQM2195C2E680JB12# |
| | | | | ±2% | GQM2195C2E750GB12# |
| | | | 75pF | ±5% | GQM2195C2E750JB12# |
| | | | | ±2% | GQM2195C2E820GB12# |
| | | | 82pF | ±5% | GQM2195C2E820JB12# |
| | | | | ±2% | GQM2195C2E910GB12# |
| 91pF | ±5% | GQM2195C2E910JB12# | | | |
| | ±2% | GQM2195C2E101GB12# | | | |
| 100pF | ±5% | GQM2195C2E101JB12# | | | |

| T max. | Rated Voltage | TC Code | Cap. | Tol. | Part Number |
|--------|---------------|--------------------|-------|---------|--------------------|
| 1.35mm | 500Vdc | C0G | 1.8pF | ±0.1pF | GQM22M5C2H1R8BB01# |
| | | | | ±0.25pF | GQM22M5C2H1R8CB01# |
| | | | 2.0pF | ±0.1pF | GQM22M5C2H2R0BB01# |
| | | | | ±0.25pF | GQM22M5C2H2R0CB01# |
| | | | 2.2pF | ±0.1pF | GQM22M5C2H2R2BB01# |
| | | | | ±0.25pF | GQM22M5C2H2R2CB01# |
| | | | 2.4pF | ±0.1pF | GQM22M5C2H2R4BB01# |
| | | | | ±0.25pF | GQM22M5C2H2R4CB01# |
| | | | 2.7pF | ±0.1pF | GQM22M5C2H2R7BB01# |
| | | | | ±0.25pF | GQM22M5C2H2R7CB01# |
| | | | 3.0pF | ±0.1pF | GQM22M5C2H3R0BB01# |
| | | | | ±0.25pF | GQM22M5C2H3R0CB01# |
| | | | 3.3pF | ±0.1pF | GQM22M5C2H3R3BB01# |
| | | | | ±0.25pF | GQM22M5C2H3R3CB01# |
| | | | 3.6pF | ±0.1pF | GQM22M5C2H3R6BB01# |
| | | | | ±0.25pF | GQM22M5C2H3R6CB01# |
| | | | 3.9pF | ±0.1pF | GQM22M5C2H3R9BB01# |
| | | | | ±0.25pF | GQM22M5C2H3R9CB01# |
| | | | 4.0pF | ±0.1pF | GQM22M5C2H4R0BB01# |
| | | | | ±0.25pF | GQM22M5C2H4R0CB01# |
| | | | 4.3pF | ±0.1pF | GQM22M5C2H4R3BB01# |
| | | | | ±0.25pF | GQM22M5C2H4R3CB01# |
| | | | 4.7pF | ±0.1pF | GQM22M5C2H4R7BB01# |
| | | | | ±0.25pF | GQM22M5C2H4R7CB01# |
| | | | 5.0pF | ±0.1pF | GQM22M5C2H5R0BB01# |
| | | | | ±0.25pF | GQM22M5C2H5R0CB01# |
| | | | 5.1pF | ±0.25pF | GQM22M5C2H5R1CB01# |
| | | | | ±0.5pF | GQM22M5C2H5R1DB01# |
| | | | 5.6pF | ±0.25pF | GQM22M5C2H5R6CB01# |
| | | | | ±0.5pF | GQM22M5C2H5R6DB01# |
| | | | 6.0pF | ±0.25pF | GQM22M5C2H6R0CB01# |
| | | | | ±0.5pF | GQM22M5C2H6R0DB01# |
| | | | 6.2pF | ±0.25pF | GQM22M5C2H6R2CB01# |
| | | | | ±0.5pF | GQM22M5C2H6R2DB01# |
| | | | 6.8pF | ±0.25pF | GQM22M5C2H6R8CB01# |
| | | | | ±0.5pF | GQM22M5C2H6R8DB01# |
| | | | 7.0pF | ±0.25pF | GQM22M5C2H7R0CB01# |
| | | | | ±0.5pF | GQM22M5C2H7R0DB01# |
| | | | 7.5pF | ±0.25pF | GQM22M5C2H7R5CB01# |
| | | | | ±0.5pF | GQM22M5C2H7R5DB01# |
| | | | 8.0pF | ±0.25pF | GQM22M5C2H8R0CB01# |
| | | | | ±0.5pF | GQM22M5C2H8R0DB01# |
| 8.2pF | ±0.25pF | GQM22M5C2H8R2CB01# | | | |
| | ±0.5pF | GQM22M5C2H8R2DB01# | | | |
| 9.0pF | ±0.25pF | GQM22M5C2H9R0CB01# | | | |
| | ±0.5pF | GQM22M5C2H9R0DB01# | | | |
| 9.1pF | ±0.25pF | GQM22M5C2H9R1CB01# | | | |
| | ±0.5pF | GQM22M5C2H9R1DB01# | | | |
| 10pF | ±2% | GQM22M5C2H100GB01# | | | |
| | ±5% | GQM22M5C2H100JB01# | | | |
| 11pF | ±2% | GQM22M5C2H110GB01# | | | |
| | ±5% | GQM22M5C2H110JB01# | | | |
| 12pF | ±2% | GQM22M5C2H120GB01# | | | |
| | ±5% | GQM22M5C2H120JB01# | | | |

■ 2.8x2.8mm

| T max. | Rated Voltage | TC Code | Cap. | Tol. | Part Number |
|--------|---------------|---------|--------|---------|--------------------|
| 1.35mm | 500Vdc | C0G | 0.5pF | ±0.1pF | GQM22M5C2HR50BB01# |
| | | | | ±0.25pF | GQM22M5C2HR50CB01# |
| | | | 0.75pF | ±0.1pF | GQM22M5C2HR75BB01# |
| | | | | ±0.25pF | GQM22M5C2HR75CB01# |
| | | | 1.0pF | ±0.1pF | GQM22M5C2H1R0BB01# |
| | | | | ±0.25pF | GQM22M5C2H1R0CB01# |
| | | | 1.1pF | ±0.1pF | GQM22M5C2H1R1BB01# |
| | | | | ±0.25pF | GQM22M5C2H1R1CB01# |
| | | | 1.2pF | ±0.1pF | GQM22M5C2H1R2BB01# |
| | | | | ±0.25pF | GQM22M5C2H1R2CB01# |
| | | | 1.3pF | ±0.1pF | GQM22M5C2H1R3BB01# |
| | | | | ±0.25pF | GQM22M5C2H1R3CB01# |
| | | | 1.5pF | ±0.1pF | GQM22M5C2H1R5BB01# |
| | | | | ±0.25pF | GQM22M5C2H1R5CB01# |
| | | | 1.6pF | ±0.1pF | GQM22M5C2H1R6BB01# |
| | | | | ±0.25pF | GQM22M5C2H1R6CB01# |

For General Purpose
GRM Series

Capacitor Array
GNM Series

Low ESL
LL□ Series

High-Q Type
GJM Series

High Frequency
GQM Series

Monolithic Microchip
GMA Series

For Bonding
GMD Series

Product Information

Part number # indicates the package specification code.

GQM Series Temperature Compensating Type HiQ Part Number List

(→ ■ 2.8x2.8mm)

| T max. | Rated Voltage | TC Code | Cap. | Tol. | Part Number | |
|--------|---------------|--------------------|------|------|--------------------|--|
| 1.35mm | 500Vdc | C0G | 13pF | ±2% | GQM22M5C2H130GB01# | |
| | | | | ±5% | GQM22M5C2H130JB01# | |
| | | | 15pF | ±2% | GQM22M5C2H150GB01# | |
| | | | | ±5% | GQM22M5C2H150JB01# | |
| | | | 16pF | ±2% | GQM22M5C2H160GB01# | |
| | | | | ±5% | GQM22M5C2H160JB01# | |
| | | | 18pF | ±2% | GQM22M5C2H180GB01# | |
| | | | | ±5% | GQM22M5C2H180JB01# | |
| | | | 20pF | ±2% | GQM22M5C2H200GB01# | |
| | | | | ±5% | GQM22M5C2H200JB01# | |
| | | | 22pF | ±2% | GQM22M5C2H220GB01# | |
| | | | | ±5% | GQM22M5C2H220JB01# | |
| | | | 24pF | ±2% | GQM22M5C2H240GB01# | |
| | | | | ±5% | GQM22M5C2H240JB01# | |
| | | | 27pF | ±2% | GQM22M5C2H270GB01# | |
| | | | | ±5% | GQM22M5C2H270JB01# | |
| | | | 30pF | ±2% | GQM22M5C2H300GB01# | |
| | | | | ±5% | GQM22M5C2H300JB01# | |
| | | | 33pF | ±2% | GQM22M5C2H330GB01# | |
| | | | | ±5% | GQM22M5C2H330JB01# | |
| | | | 36pF | ±2% | GQM22M5C2H360GB01# | |
| | | | | ±5% | GQM22M5C2H360JB01# | |
| | | | 39pF | ±2% | GQM22M5C2H390GB01# | |
| | | | | ±5% | GQM22M5C2H390JB01# | |
| | | | 43pF | ±2% | GQM22M5C2H430GB01# | |
| | | | | ±5% | GQM22M5C2H430JB01# | |
| | | | 47pF | ±2% | GQM22M5C2H470GB01# | |
| | | | | ±5% | GQM22M5C2H470JB01# | |
| | | | 51pF | ±2% | GQM22M5C2H510GB01# | |
| | | | | ±5% | GQM22M5C2H510JB01# | |
| | | | 56pF | ±2% | GQM22M5C2H560GB01# | |
| | | | | ±5% | GQM22M5C2H560JB01# | |
| | | | 62pF | ±2% | GQM22M5C2H620GB01# | |
| | | | | ±5% | GQM22M5C2H620JB01# | |
| | | | 68pF | ±2% | GQM22M5C2H680GB01# | |
| | | | | ±5% | GQM22M5C2H680JB01# | |
| | | | 75pF | ±2% | GQM22M5C2H750GB01# | |
| | | | | ±5% | GQM22M5C2H750JB01# | |
| | | | 82pF | ±2% | GQM22M5C2H820GB01# | |
| | | | | ±5% | GQM22M5C2H820JB01# | |
| | | | 91pF | ±2% | GQM22M5C2H910GB01# | |
| | | | | ±5% | GQM22M5C2H910JB01# | |
| 100pF | ±2% | GQM22M5C2H101GB01# | | | | |
| | ±5% | GQM22M5C2H101JB01# | | | | |

For General Purpose GRM Series

Capacitor Array GNM Series

Low ESL LLD Series

High-Q Type GJM Series

High Frequency GQM Series

Monolithic Microchip GMA Series

For Bonding GMD Series

Product Information

Part number # indicates the package specification code.

Chip Monolithic Ceramic Capacitors

Monolithic Microchip GMA Series

Capacitor for wire bonding. Can also be mounted directly to a frame!!

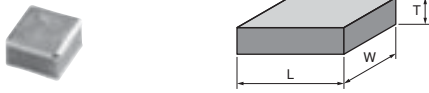

- 1 Excellent high frequency characteristics.
- 2 Ideal for bypass applications.
- 3 High density mounting is possible.

For General Purpose
GRM Series

Capacitor Array
GNM Series

Low ESL
LLQ Series

High-Q Type
GJM Series

High Frequency
GQM Series

Monolithic Microchip
GMA Series

For Bonding
GMD Series

Product Information

GMA Series High Dielectric Constant Type Part Number List

■ 0.38x0.38mm Ultra-compact

| T max. | Rated Voltage | TC Code | Cap. | Tol. | Part Number |
|--------|---------------|---------|---------|------|---------------------------|
| 0.35mm | 10Vdc | X7R | 10000pF | ±20% | GMA0D3R71A103MA01# |
| | | R | 10000pF | ±20% | GMA0D3R11A103MA01# |

■ 0.5x0.5mm Ultra-compact

| T max. | Rated Voltage | TC Code | Cap. | Tol. | Part Number | |
|--------|---------------|---------|---------|---------------------------|---------------------------|---------------------------|
| 0.4mm | 100Vdc | X7R | 100pF | ±20% | GMA05XR72A101MA01# | |
| | | | 150pF | ±20% | GMA05XR72A151MA01# | |
| | | | 220pF | ±20% | GMA05XR72A221MA01# | |
| | | | 330pF | ±20% | GMA05XR72A331MA01# | |
| | | | 470pF | ±20% | GMA05XR72A471MA01# | |
| | | | 680pF | ±20% | GMA05XR72A681MA01# | |
| | | | 1000pF | ±20% | GMA05XR72A102MA01# | |
| | | | 25Vdc | X7R | 1500pF | ±20% |
| | | 2200pF | ±20% | | GMA05XR71E222MA11# | |
| | | 3300pF | ±20% | | GMA05XR71E332MA11# | |
| | | 4700pF | ±20% | | GMA05XR71E472MA11# | |
| | | B | 1500pF | | ±20% | GMA05XB31E152MA11# |
| | | | 2200pF | | ±20% | GMA05XB31E222MA11# |
| | | | 3300pF | ±20% | GMA05XB31E332MA11# | |
| | 4700pF | | ±20% | GMA05XB31E472MA11# | | |
| | 10Vdc | X7R | 6800pF | ±20% | GMA05XR71A682MA01# | |
| | | | 10000pF | ±20% | GMA05XR71A103MA01# | |
| | | | 15000pF | ±20% | GMA05XR71A153MA01# | |
| | | | 22000pF | ±20% | GMA05XR71A223MA01# | |
| | | | R | 6800pF | ±20% | GMA05XR11A682MA01# |
| | | | | 10000pF | ±20% | GMA05XR11A103MA01# |
| | | 15000pF | | ±20% | GMA05XR11A153MA01# | |
| | | 22000pF | | ±20% | GMA05XR11A223MA01# | |
| | | B | 6800pF | ±20% | GMA05XB11A682MA01# | |
| | | | 10000pF | ±20% | GMA05XB11A103MA01# | |
| | | | 15000pF | ±20% | GMA05XB11A153MA01# | |
| | | | 22000pF | ±20% | GMA05XB11A223MA01# | |
| | | 6.3Vdc | X5R | 0.1μF | ±20% | GMA05XR60J104ME12# |
| | | | B | 0.1μF | ±20% | GMA05XB30J104ME12# |

■ 0.8x0.8mm

| T max. | Rated Voltage | TC Code | Cap. | Tol. | Part Number |
|--------|---------------|---------|---------------------------|---------------------------|---------------------------|
| 0.6mm | 100Vdc | X7R | 1500pF | ±20% | GMA085R72A152MA01# |
| | | | 2200pF | ±20% | GMA085R72A222MA01# |
| | | | 3300pF | ±20% | GMA085R72A332MA01# |
| | | | 4700pF | ±20% | GMA085R72A472MA01# |
| | | | 6800pF | ±20% | GMA085R72A682MA01# |
| | | | 25Vdc | X7R | 10000pF |
| | 15000pF | ±20% | GMA085R71E153MA11# | | |
| | 22000pF | ±20% | GMA085R71E223MA11# | | |
| | B | 10000pF | ±20% | | GMA085B31E103MA11# |
| | | 15000pF | ±20% | GMA085B31E153MA11# | |
| | | 22000pF | ±20% | GMA085B31E223MA11# | |

| T max. | Rated Voltage | TC Code | Cap. | Tol. | Part Number | |
|--------|---------------|---------|---------|---------------------------|---------------------------|---------------------------|
| 0.6mm | 10Vdc | X7R | 33000pF | ±20% | GMA085R71A333MA01# | |
| | | | 47000pF | ±20% | GMA085R71A473MA01# | |
| | | | 68000pF | ±20% | GMA085R71A683MA01# | |
| | | | 0.1μF | ±20% | GMA085R71A104MA01# | |
| | | R | 33000pF | ±20% | GMA085R11A333MA01# | |
| | | | 47000pF | ±20% | GMA085R11A473MA01# | |
| | | | 68000pF | ±20% | GMA085R11A683MA01# | |
| | | | 0.1μF | ±20% | GMA085R11A104MA01# | |
| | | | B | 33000pF | ±20% | GMA085B11A333MA01# |
| | | | | 47000pF | ±20% | GMA085B11A473MA01# |
| | 68000pF | ±20% | | GMA085B11A683MA01# | | |
| | 0.1μF | ±20% | | GMA085B11A104MA01# | | |
| | 6.3Vdc | X5R | 0.47μF | ±20% | GMA085R60J474ME12# | |
| | | | B | 0.47μF | ±20% | GMA085B30J474ME12# |

Part number # indicates the package specification code.

For General Purpose GRM Series

Capacitor Array GNM Series

Low ESL LLD Series

High-Q Type GJM Series

High Frequency GQM Series

Monolithic Microchip GMA Series

For Bonding GMD Series

Product Information

Chip Monolithic Ceramic Capacitors

For Bonding GMD Series

Capacitor for wire bonding. Compatible up to 0.6x0.3mm size!!

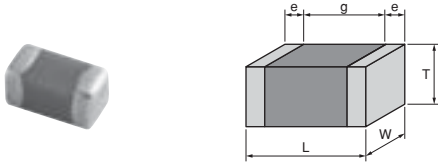

- 1 Compact product sizes of 0.6x0.3x0.3mm, 1.0x0.5x0.5mm
- 2 Can be mounted by wire bonding and AuSn soldering.
- 3 Ideal for mounting in optical communication related devices and IC packages.

For General Purpose
GRM Series

Capacitor Array
GNM Series

Low ESL
LLQ Series

High-Q Type
GJM Series

High Frequency
GQM Series

Monolithic Microchip
GMA Series

For Bonding
GMD Series

Product Information

GMD Series High Dielectric Constant Type Part Number List

0.6x0.3mm Ultra-compact

| T max. | Rated Voltage | TC Code | Cap. | Tol. | Part Number | |
|--------|---------------|---------|--------|--------|--------------------|--------------------|
| 0.33mm | 25Vdc | X7R | 100pF | ±10% | GMD033R71E101KA01# | |
| | | | 120pF | ±10% | GMD033R71E121KA01# | |
| | | | 150pF | ±10% | GMD033R71E151KA01# | |
| | | | 180pF | ±10% | GMD033R71E181KA01# | |
| | | | 220pF | ±10% | GMD033R71E221KA01# | |
| | | | 270pF | ±10% | GMD033R71E271KA01# | |
| | | | 330pF | ±10% | GMD033R71E331KA01# | |
| | | | 390pF | ±10% | GMD033R71E391KA01# | |
| | | | 470pF | ±10% | GMD033R71E471KA01# | |
| | | | 560pF | ±10% | GMD033R71E561KA01# | |
| | | | 680pF | ±10% | GMD033R71E681KA01# | |
| | | | 820pF | ±10% | GMD033R71E821KA01# | |
| | | | 1000pF | ±10% | GMD033R71E102KA01# | |
| | | | 1200pF | ±10% | GMD033R71E122KA01# | |
| | | | 1500pF | ±10% | GMD033R71E152KA01# | |
| | | | R | 100pF | ±10% | GMD033R11E101KA01# |
| | | | | 120pF | ±10% | GMD033R11E121KA01# |
| | | | | 150pF | ±10% | GMD033R11E151KA01# |
| | | | | 180pF | ±10% | GMD033R11E181KA01# |
| | | | | 220pF | ±10% | GMD033R11E221KA01# |
| | | | | 270pF | ±10% | GMD033R11E271KA01# |
| | | | | 330pF | ±10% | GMD033R11E331KA01# |
| | | | | 390pF | ±10% | GMD033R11E391KA01# |
| | | | | 470pF | ±10% | GMD033R11E471KA01# |
| | | | | 560pF | ±10% | GMD033R11E561KA01# |
| | | | | 680pF | ±10% | GMD033R11E681KA01# |
| | | | | 820pF | ±10% | GMD033R11E821KA01# |
| | | 1000pF | | ±10% | GMD033R11E102KA01# | |
| | | 1200pF | | ±10% | GMD033R11E122KA01# | |
| | | 1500pF | | ±10% | GMD033R11E152KA01# | |
| | | B | | 100pF | ±10% | GMD033B11E101KA01# |
| | | | | 120pF | ±10% | GMD033B11E121KA01# |
| | | | | 150pF | ±10% | GMD033B11E151KA01# |
| | | | | 180pF | ±10% | GMD033B11E181KA01# |
| | | | | 220pF | ±10% | GMD033B11E221KA01# |
| | | | | 270pF | ±10% | GMD033B11E271KA01# |
| | | | | 330pF | ±10% | GMD033B11E331KA01# |
| | | | | 390pF | ±10% | GMD033B11E391KA01# |
| | | | | 470pF | ±10% | GMD033B11E471KA01# |
| | | | | 560pF | ±10% | GMD033B11E561KA01# |
| | | | | 680pF | ±10% | GMD033B11E681KA01# |
| | | | | 820pF | ±10% | GMD033B11E821KA01# |
| | | | 1000pF | ±10% | GMD033B11E102KA01# | |
| | | | 1200pF | ±10% | GMD033B11E122KA01# | |
| | | | 1500pF | ±10% | GMD033B11E152KA01# | |
| | | 16Vdc | X7R | 1800pF | ±10% | GMD033R71C182KA11# |
| | | | | 2200pF | ±10% | GMD033R71C222KA11# |
| | | | | 2700pF | ±10% | GMD033R71C272KA11# |
| | | | | 3300pF | ±10% | GMD033R71C332KA11# |
| | | | | R | 1800pF | ±10% |
| | | | 2200pF | ±10% | GMD033R11C222KA11# | |
| | | | 2700pF | ±10% | GMD033R11C272KA11# | |

| T max. | Rated Voltage | TC Code | Cap. | Tol. | Part Number | |
|---------|---------------|---------|--------------------|--------------------|--------------------|--------------------|
| 0.33mm | 16Vdc | R | 3300pF | ±10% | GMD033R11C332KA11# | |
| | | | B | 1800pF | ±10% | GMD033B31C182KA11# |
| | | | 2200pF | ±10% | GMD033B31C222KA11# | |
| | | | 2700pF | ±10% | GMD033B31C272KA11# | |
| | | 3300pF | ±10% | GMD033B31C332KA11# | | |
| | | 10Vdc | X7R | 3900pF | ±10% | GMD033R71A392KA01# |
| | | | | 4700pF | ±10% | GMD033R71A472KA01# |
| | | | | 5600pF | ±10% | GMD033R71A562KA01# |
| | | | | 6800pF | ±10% | GMD033R71A682KA01# |
| | | | | 8200pF | ±10% | GMD033R71A822KA01# |
| | | | | 10000pF | ±10% | GMD033R71A103KA01# |
| | | | | R | 3900pF | ±10% |
| | 4700pF | | | | ±10% | GMD033R11A472KA01# |
| | 5600pF | | | | ±10% | GMD033R11A562KA01# |
| | 6800pF | | | | ±10% | GMD033R11A682KA01# |
| | 8200pF | | ±10% | | GMD033R11A822KA01# | |
| | B | | 3900pF | ±10% | GMD033B11A392KA01# | |
| | | | 4700pF | ±10% | GMD033B11A472KA01# | |
| | | | 5600pF | ±10% | GMD033B11A562KA01# | |
| | | | 6800pF | ±10% | GMD033B11A682KA01# | |
| | | 8200pF | ±10% | GMD033B11A822KA01# | | |
| | 6.3Vdc | X5R | 56000pF | ±10% | GMD033R60J563KE11# | |
| | | | 68000pF | ±10% | GMD033R60J683KE11# | |
| | | | 82000pF | ±10% | GMD033R60J823KE11# | |
| | | | 0.1μF | ±10% | GMD033R60J104KE11# | |
| | | | B | 56000pF | ±10% | GMD033B30J563KE11# |
| | | | 68000pF | ±10% | GMD033B30J683KE11# | |
| 82000pF | | ±10% | GMD033B30J823KE11# | | | |
| 0.1μF | | ±10% | GMD033B30J104KE11# | | | |

1.0x0.5mm

| T max. | Rated Voltage | TC Code | Cap. | Tol. | Part Number |
|--------|---------------|---------|--------|------|--------------------|
| 0.55mm | 50Vdc | X7R | 220pF | ±10% | GMD155R71H221KA01# |
| | | | 270pF | ±10% | GMD155R71H271KA01# |
| | | | 330pF | ±10% | GMD155R71H331KA01# |
| | | | 390pF | ±10% | GMD155R71H391KA01# |
| | | | 470pF | ±10% | GMD155R71H471KA01# |
| | | | 560pF | ±10% | GMD155R71H561KA01# |
| | | | 680pF | ±10% | GMD155R71H681KA01# |
| | | | 820pF | ±10% | GMD155R71H821KA01# |
| | | | 1000pF | ±10% | GMD155R71H102KA01# |
| | | | 1200pF | ±10% | GMD155R71H122KA01# |
| | | | 1500pF | ±10% | GMD155R71H152KA01# |
| | | | 1800pF | ±10% | GMD155R71H182KA01# |
| | | | 2200pF | ±10% | GMD155R71H222KA01# |
| | | | 2700pF | ±10% | GMD155R71H272KA01# |
| | | | 3300pF | ±10% | GMD155R71H332KA01# |
| | | R | 3900pF | ±10% | GMD155R71H392KA01# |
| | | | 4700pF | ±10% | GMD155R71H472KA01# |
| | | | 220pF | ±10% | GMD155R11H221KA01# |

Part number # indicates the package specification code.

For General Purpose GRM Series
 Capacitor Array GNM Series
 Low ESL LL Series
 High-Q Type GJM Series
 High Frequency GQM Series
 Monolithic Microchip GMA Series
 For Bonding GMD Series
 Product Information

GMD Series High Dielectric Constant Type Part Number List

(→ ■ 1.0x0.5mm)

| T max. | Rated Voltage | TC Code | Cap. | Tol. | Part Number | | |
|---------|---------------|---------|---------------------------|---------------------------|---------------------------|---------------------------|--|
| 0.55mm | 50Vdc | R | 270pF | ±10% | GMD155R11H271KA01# | | |
| | | | 330pF | ±10% | GMD155R11H331KA01# | | |
| | | | 390pF | ±10% | GMD155R11H391KA01# | | |
| | | | 470pF | ±10% | GMD155R11H471KA01# | | |
| | | | 560pF | ±10% | GMD155R11H561KA01# | | |
| | | | 680pF | ±10% | GMD155R11H681KA01# | | |
| | | | 820pF | ±10% | GMD155R11H821KA01# | | |
| | | | 1000pF | ±10% | GMD155R11H102KA01# | | |
| | | | 1200pF | ±10% | GMD155R11H122KA01# | | |
| | | | 1500pF | ±10% | GMD155R11H152KA01# | | |
| | | | 1800pF | ±10% | GMD155R11H182KA01# | | |
| | | | 2200pF | ±10% | GMD155R11H222KA01# | | |
| | | | 2700pF | ±10% | GMD155R11H272KA01# | | |
| | | | 3300pF | ±10% | GMD155R11H332KA01# | | |
| | | | 3900pF | ±10% | GMD155R11H392KA01# | | |
| | | | 4700pF | ±10% | GMD155R11H472KA01# | | |
| | | | B | 220pF | ±10% | GMD155B11H221KA01# | |
| | | | | 270pF | ±10% | GMD155B11H271KA01# | |
| | | | | 330pF | ±10% | GMD155B11H331KA01# | |
| | | | | 390pF | ±10% | GMD155B11H391KA01# | |
| | | | | 470pF | ±10% | GMD155B11H471KA01# | |
| | | 560pF | | ±10% | GMD155B11H561KA01# | | |
| | | 680pF | | ±10% | GMD155B11H681KA01# | | |
| | | 820pF | | ±10% | GMD155B11H821KA01# | | |
| | | 1000pF | | ±10% | GMD155B11H102KA01# | | |
| | | 1200pF | | ±10% | GMD155B11H122KA01# | | |
| | | 1500pF | | ±10% | GMD155B11H152KA01# | | |
| | | 1800pF | | ±10% | GMD155B11H182KA01# | | |
| | | 2200pF | | ±10% | GMD155B11H222KA01# | | |
| | | 2700pF | | ±10% | GMD155B11H272KA01# | | |
| | | 3300pF | | ±10% | GMD155B11H332KA01# | | |
| | | 3900pF | | ±10% | GMD155B11H392KA01# | | |
| | | 4700pF | | ±10% | GMD155B11H472KA01# | | |
| | | X7R | | 5600pF | ±10% | GMD155R71E562KA01# | |
| | | | | 6800pF | ±10% | GMD155R71E682KA01# | |
| | | | | 8200pF | ±10% | GMD155R71E822KA01# | |
| | | | | 10000pF | ±10% | GMD155R71E103KA01# | |
| | | | | 12000pF | ±10% | GMD155R71E123KA01# | |
| | | | | 15000pF | ±10% | GMD155R71E153KA01# | |
| | | | | 18000pF | ±10% | GMD155R71E183KA01# | |
| | | | | 22000pF | ±10% | GMD155R71E223KA01# | |
| | | | | 27000pF | ±10% | GMD155R71E273KA11# | |
| | | | 33000pF | ±10% | GMD155R71E333KA11# | | |
| | | | 39000pF | ±10% | GMD155R71E393KA11# | | |
| | | | 47000pF | ±10% | GMD155R71E473KA11# | | |
| | | | R | 5600pF | ±10% | GMD155R11E562KA01# | |
| | | | | 6800pF | ±10% | GMD155R11E682KA01# | |
| 8200pF | ±10% | | | GMD155R11E822KA01# | | | |
| 10000pF | ±10% | | | GMD155R11E103KA01# | | | |
| 12000pF | ±10% | | | GMD155R11E123KA01# | | | |
| 15000pF | ±10% | | | GMD155R11E153KA01# | | | |
| 18000pF | ±10% | | | GMD155R11E183KA01# | | | |
| 22000pF | ±10% | | | GMD155R11E223KA01# | | | |
| 27000pF | ±10% | | | GMD155R11E273KA11# | | | |
| 25Vdc | X7R | 0.1μF | | ±10% | GMD155R71C104KA11# | | |
| | | 0.15μF | | ±10% | GMD155R61A154KE12# | | |
| | | 0.18μF | | ±10% | GMD155R61A184KE12# | | |
| | | 0.22μF | | ±10% | GMD155R61A224KE12# | | |
| | | 0.27μF | | ±10% | GMD155R61A274KE11# | | |
| | | 0.33μF | | ±10% | GMD155R61A334KE11# | | |
| | | 0.39μF | | ±10% | GMD155R61A394KE11# | | |
| | | 0.47μF | ±10% | GMD155R61A474KE11# | | | |
| | | B | 0.12μF | ±10% | GMD155B31A124KE12# | | |
| | | | 0.15μF | ±10% | GMD155B31A154KE12# | | |
| 0.18μF | ±10% | | GMD155B31A184KE12# | | | | |
| 0.22μF | ±10% | | GMD155B31A224KE12# | | | | |
| 0.27μF | ±10% | | GMD155B31A274KE11# | | | | |
| 0.33μF | ±10% | | GMD155B31A334KE11# | | | | |
| 0.39μF | ±10% | | GMD155B31A394KE11# | | | | |
| 0.47μF | ±10% | | GMD155B31A474KE11# | | | | |
| R | 0.12μF | | ±10% | GMD155R61A124KE12# | | | |
| | 0.15μF | | ±10% | GMD155R61A154KE12# | | | |
| | 0.18μF | ±10% | GMD155R61A184KE12# | | | | |
| | 0.22μF | ±10% | GMD155R61A224KE12# | | | | |
| | 0.27μF | ±10% | GMD155R61A274KE11# | | | | |
| | 0.33μF | ±10% | GMD155R61A334KE11# | | | | |
| | 0.39μF | ±10% | GMD155R61A394KE11# | | | | |
| | 0.47μF | ±10% | GMD155R61A474KE11# | | | | |
| | 16Vdc | X7R | 56000pF | ±10% | GMD155R71C563KA11# | | |
| | | | 68000pF | ±10% | GMD155R71C683KA11# | | |
| 82000pF | | | ±10% | GMD155R71C823KA11# | | | |
| 0.1μF | | | ±10% | GMD155R71C104KA11# | | | |
| 0.15μF | | | ±10% | GMD155R61A154KE12# | | | |
| R | | 56000pF | ±10% | GMD155R11C563KA11# | | | |
| | | 68000pF | ±10% | GMD155R11C683KA11# | | | |
| | | 82000pF | ±10% | GMD155R11C823KA11# | | | |
| | | 0.1μF | ±10% | GMD155R11C104KA11# | | | |
| | | 0.15μF | ±10% | GMD155R61A154KE12# | | | |
| B | 56000pF | ±10% | GMD155B31C563KA11# | | | | |
| | 68000pF | ±10% | GMD155B31C683KA11# | | | | |
| | 82000pF | ±10% | GMD155B31C823KA11# | | | | |
| | 0.1μF | ±10% | GMD155B31C104KA11# | | | | |
| | 0.15μF | ±10% | GMD155R61A154KE12# | | | | |
| 10Vdc | X5R | 0.12μF | ±10% | GMD155R61A124KE12# | | | |
| | | 0.15μF | ±10% | GMD155R61A154KE12# | | | |
| | | 0.18μF | ±10% | GMD155R61A184KE12# | | | |
| | | 0.22μF | ±10% | GMD155R61A224KE12# | | | |
| | | 0.27μF | ±10% | GMD155R61A274KE11# | | | |
| | B | 0.33μF | ±10% | GMD155R61A334KE11# | | | |
| | | 0.39μF | ±10% | GMD155R61A394KE11# | | | |
| | | 0.47μF | ±10% | GMD155R61A474KE11# | | | |
| | | 0.12μF | ±10% | GMD155B31A124KE12# | | | |
| | | 0.15μF | ±10% | GMD155B31A154KE12# | | | |

For General Purpose GRM Series
 Capacitor Array GNM Series
 Low ESL LL□ Series
 High-Q Type GJM Series
 High Frequency GQM Series
 Monolithic Microchip GMA Series
 For Bonding GMD Series
 Product Information

Part number # indicates the package specification code.

For General

⚠Caution/Notice

⚠Caution

Notice

- Storage and Operation Conditions 119
- Rating 119
 - 1. Temperature Dependent Characteristics 119
 - 2. Measurement of Capacitance 120
 - 3. Applied Voltage 120
 - 4. Applied Voltage and Self-heating Temperature 120
 - 5. DC Voltage and AC Voltage Characteristic 121
 - 6. Capacitance Aging 121
 - 7. Vibration and Shock 122
- Soldering and Mounting 122
 - 1. Mounting Position 122
 - 2. Information before Mounting 123
 - 3. Maintenance of the Mounting (pick and place) Machine 123
 - 4-1. Reflow Soldering 124
 - 4-2. Flow Soldering 125
 - 4-3. Correction with a Soldering Iron 126
 - 4-4. Leaded Component Insertion 126
 - 5. Washing 126
 - 6. Electrical Test on Printed Circuit Board 127
 - 7. Printed Circuit Board Cropping 127
- Others 128
 - 1. Under Operation of Equipment 128
 - 2. Others 128

- Rating 129
 - 1. Operating Temperature 129
 - 2. Atmosphere Surroundings 129
 - 3. Piezo-electric Phenomenon 129
- Soldering and Mounting 129
 - 1. PCB Design 129
 - 1. Notice for Pattern Forms 129
 - 2. Land Dimensions 130
 - 2. Adhesive Application 131
 - 3. Adhesive Curing 132
 - 4. Flux Application 132
 - 5. Flow Soldering 132
 - 6. Washing 132
 - 7. Coating 133
 - 8. Die Bonding/Wire Bonding (GMA or GMD Series) 133
- Others 133
 - 1. Transportation 133

For General Purpose GRM Series

Capacitor Array GNM Series

Low ESL LLI Series

High-Q Type GJM Series

High Frequency GQM Series

Monolithic Microchip GMA Series

For Bonding GMD Series

Product Information
 ⚠Caution/Notice



■ Storage and Operation Conditions

1. The performance of chip monolithic ceramic capacitors may be affected by the storage conditions.

1-1. Store capacitors in the following conditions:

Temperature of +5°C to +40°C and a Relative Humidity of 20% to 70%.

(1) Sunlight, dust, rapid temperature changes, corrosive gas atmosphere or high temperature and humidity conditions during storage may affect solderability and packaging performance. Please use product within six months of receipt.

(2) Please confirm solderability before using after six months. Store the capacitors without opening the original bag. Even if the storage period is short, do not exceed the specified atmospheric conditions.

1-2. Corrosive gas can react with the termination (external) electrodes or lead wires of capacitors, and result in poor solderability. Do not store the capacitors in an atmosphere consisting of corrosive gas (e.g., hydrogen sulfide, sulfur dioxide, chlorine, ammonia gas, etc.).

1-3. Due to moisture condensation caused by rapid humidity changes, or the photochemical change caused by direct sunlight on the terminal electrodes and/or the resin/epoxy coatings, the solderability and electrical performance may deteriorate. Do not store capacitors under direct sunlight or in high humidity conditions.

■ Rating

1. Temperature Dependent Characteristics

1. The electrical characteristics of the capacitor can change with temperature.

1-1. For capacitors having larger temperature dependency, the capacitance may change with temperature changes.

The following actions are recommended in order to ensure suitable capacitance values.

(1) Select a suitable capacitance for the operating temperature range.

(2) The capacitance may change within the rated temperature.

When you use a high dielectric constant type capacitor in a circuit that needs a tight (narrow) capacitance tolerance (e.g., a time-constant circuit), please carefully consider the characteristics of these capacitors, such as their aging, voltage, and temperature characteristics. In addition, check capacitors using your actual appliances at the intended environment and operating conditions.

Typical Temperature Characteristics R6(X5R)

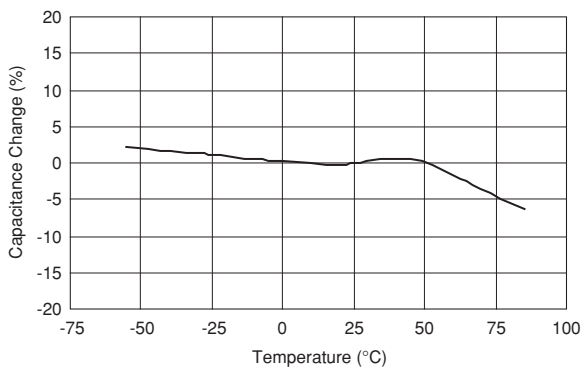

Typical Temperature Characteristics R7(X7R)

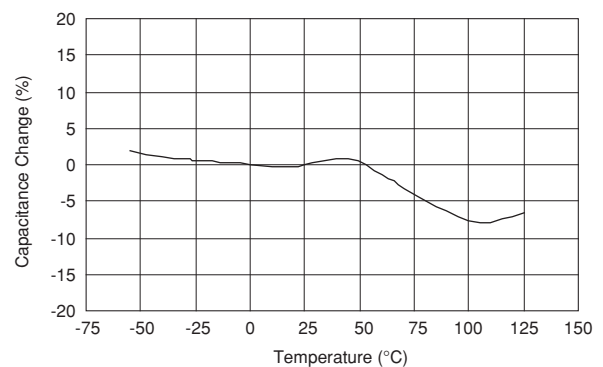

Typical Temperature Characteristics F5(Y5V)

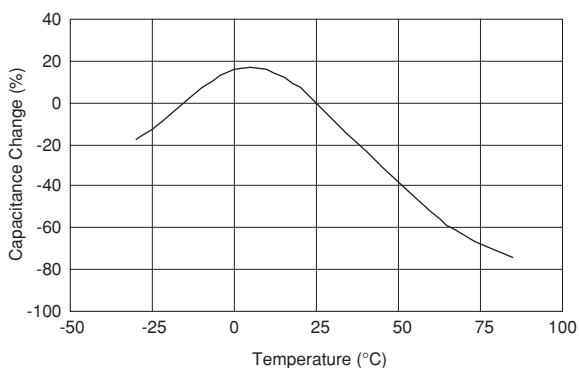

For General Purpose
GRM Series

Capacitor Array
GNM Series

Low ESL
LL□ Series

High-Q Type
GJM Series

High Frequency
GQM Series

Monolithic Microchip
GMA Series

For Bonding
GMD Series

Product Information
⚠Caution

⚠Caution

↳ Continued from the preceding page.

2. Measurement of Capacitance

1. Measure capacitance with the voltage and the frequency specified in the product specifications.

- 1-1. The output voltage of the measuring equipment may decrease occasionally when capacitance is high. Please confirm whether a prescribed measured voltage is impressed to the capacitor.

- 1-2. The capacitance values of high dielectric constant type capacitors change depending on the AC voltage applied. Please consider the AC voltage characteristics when selecting a capacitor to be used in an AC circuit.

3. Applied Voltage

1. Do not apply a voltage to the capacitor that exceeds the rated voltage as called out in the specifications.

- 1-1. Applied voltage between the terminals of a capacitor shall be less than or equal to the rated voltage.
 - (1) When AC voltage is superimposed on DC voltage, the zero-to-peak voltage shall not exceed the rated DC voltage. When AC voltage or pulse voltage is applied, the peak-to-peak voltage shall not exceed the rated DC voltage.
 - (2) Abnormal voltages (surge voltage, static electricity, pulse voltage, etc.) shall not exceed the rated DC voltage.

Typical Voltage Applied to the DC Capacitor

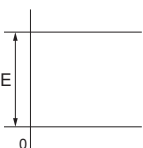
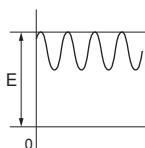
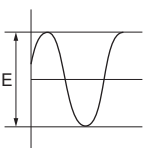
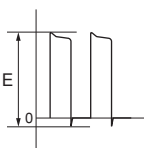
| DC Voltage | DC Voltage+AC | AC Voltage | Pulse Voltage |
|---|---|--|---|
|  |  |  |  |

(E: Maximum possible applied voltage.)

1-2. Influence of overvoltage

Overvoltage that is applied to the capacitor may result in an electrical short circuit caused by the breakdown of the internal dielectric layers. The time duration until breakdown depends on the applied voltage and the ambient temperature.

4. Applied Voltage and Self-heating Temperature

1. When the capacitor is used in a high-frequency voltage, pulse voltage, application, be sure to take into account self-heating may be caused by resistant factors of the capacitor.

- 1-1. The load should be contained to the level such that when measuring at atmospheric temperature of 25°C, the product's self-heating remains below 20°C and surface temperature of the capacitor in the actual circuit remains within the maximum operating temperature.

Continued on the following page. ↗

For General Purpose GRM Series
 Capacitor Array GNM Series
 Low ESL LLQ Series
 High-Q Type GJM Series
 High Frequency GQM Series
 Monolithic Microchip GMA Series
 For Bonding GMD Series
 Product Information ⚠Caution



↳ Continued from the preceding page.

5. DC Voltage and AC Voltage Characteristics

1. The capacitance value of a high dielectric constant type capacitor changes depending on the DC voltage applied. Please consider the DC voltage characteristics when a capacitor is selected for use in a DC circuit.

1-1. The capacitance of ceramic capacitors may change sharply depending on the applied voltage (see figure).

Please confirm the following in order to secure the capacitance.

- (1) Determine whether the capacitance change caused by the applied voltage is within the allowed range.
- (2) In the DC voltage characteristics, the rate of capacitance change becomes larger as voltage increases, even if the applied voltage is below the rated voltage. When a high dielectric constant type capacitor is in a circuit that needs a tight (narrow) capacitance tolerance (e.g., a time-constant circuit), please carefully consider the characteristics of these capacitors, such as their aging, voltage, and temperature characteristics. In addition, check capacitors using your actual appliances at the intended environment and operating conditions.

2. The capacitance values of high dielectric constant type capacitors change depending on the AC voltage applied. Please consider the AC voltage characteristics when selecting a capacitor to be used in an AC circuit.

[DC Voltage Characteristics]

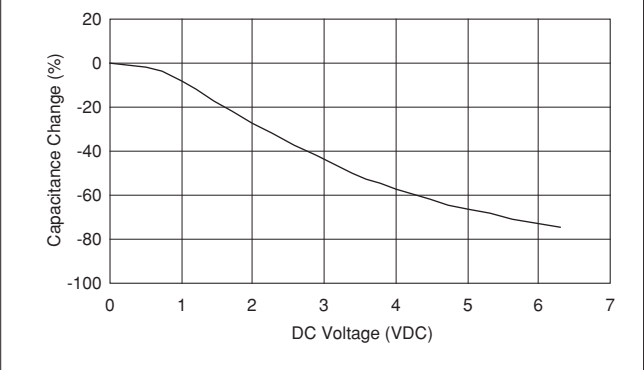

[AC Voltage Characteristics]

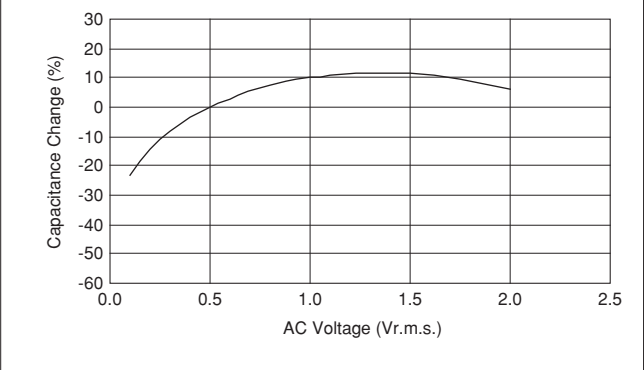

6. Capacitance Aging

1. The high dielectric constant type capacitors have the characteristic in which the capacitance value decreases with the passage of time.

When you use a high dielectric constant type capacitors in a circuit that needs a tight (narrow) capacitance tolerance (e.g., a time-constant circuit), please carefully consider the characteristics of these capacitors, such as their aging, voltage, and temperature characteristics. In addition, check capacitors using your actual appliances at the intended environment and operating conditions.

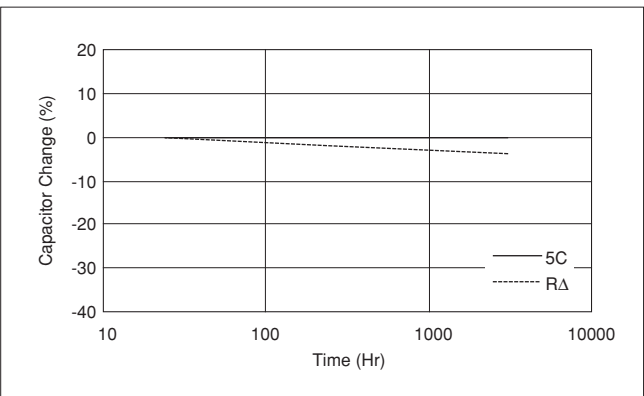

Continued on the following page. ↗

For General Purpose
GRM Series

Capacitor Array
GJM Series

Low ESL
LLQ Series

High-Q Type
GJM Series

High Frequency
GQM Series

Monolithic Microchip
GMA Series

For Bonding
GMD Series

Product Information
⚠Caution

⚠Caution

☐ Continued from the preceding page.

7. Vibration and Shock

1. Please confirm the kind of vibration and/or shock, its condition, and any generation of resonance.
 Please mount the capacitor so as not to generate resonance, and do not allow any impact on the terminals.
2. Mechanical shock due to being dropped may cause damage or a crack in the dielectric material of the capacitor.
 Do not use a dropped capacitor because the quality and reliability may be deteriorated.
3. When printed circuit boards are piled up or handled, the corner of another printed circuit board should not be allowed to hit the capacitor, in order to avoid a crack or other damage to the capacitor.

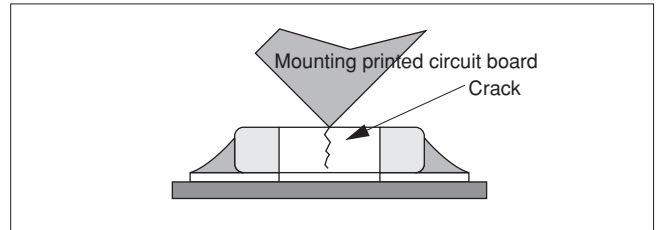
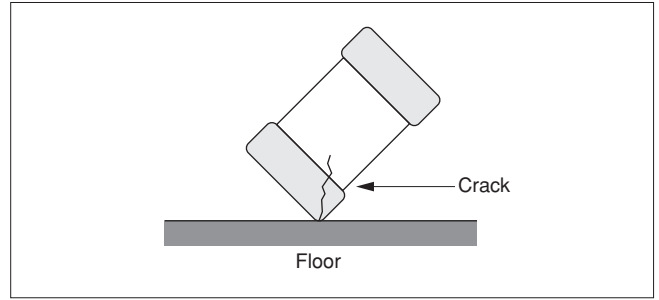

■ Soldering and Mounting

1. Mounting Position

1. Confirm the best mounting position and direction that minimizes the stress imposed on the capacitor during flexing or bending the printed circuit board.
 - 1-1. Choose a mounting position that minimizes the stress imposed on the chip during flexing or bending of the board.

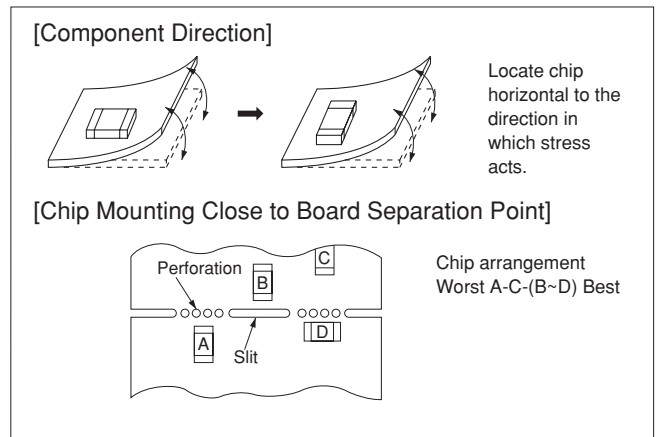

Continued on the following page. ☐

For General Purpose GRM Series
 Capacitor Array GNM Series
 Low ESL LLQ Series
 High-Q Type GJM Series
 High Frequency GQM Series
 Monolithic Microchip GMA Series
 For Bonding GMD Series
 Product Information ⚠Caution

⚠Caution

☐ Continued from the preceding page.

2. Information before Mounting

1. Do not reuse capacitors that were removed from the equipment.
2. Confirm capacitance characteristics under actual applied voltage.
3. Confirm the mechanical stress under actual process and equipment use.
4. Confirm the rated capacitance, rated voltage and other electrical characteristics before assembly.
5. Prior to use, confirm the solderability of capacitors that were in long-term storage.
6. Prior to measuring capacitance, carry out a heat treatment for capacitors that were in long-term storage.
7. The use of Sn-Zn based solder will deteriorate the reliability of the MLCC.

Please contact our sales representative or product engineers on the use of Sn-Zn based solder in advance.

3. Maintenance of the Mounting (pick and place) Machine

1. Make sure that the following excessive forces are not applied to the capacitors.
 - 1-1. In mounting the capacitors on the printed circuit board, any bending force against them shall be kept to a minimum to prevent them from any bending damage or cracking. Please take into account the following precautions and recommendations for use in your process.
 - (1) Adjust the lowest position of the pickup nozzle so as not to bend the printed circuit board.
 - (2) Adjust the nozzle pressure within a static load of 1N to 3N during mounting.
2. Dirt particles and dust accumulated between the suction nozzle and the cylinder inner wall prevent the nozzle from moving smoothly. This imposes greater force upon the chip during mounting, causing cracked chips. Also, the locating claw, when worn out, imposes uneven forces on the chip when positioning, causing cracked chips. The suction nozzle and the locating claw must be maintained, checked and replaced periodically.

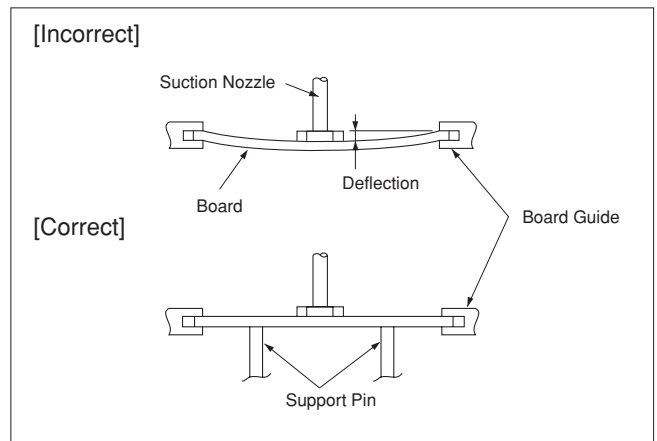

Continued on the following page. ↗

For General Purpose
GRM Series

Capacitor Array
GNM Series

Low ESL
LLC Series

High-Q Type
GJM Series

High Frequency
GQM Series

Monolithic Microchip
GMA Series

For Bonding
GMD Series

Product Information
⚠Caution

⚠Caution

☐ Continued from the preceding page.

4-1. Reflow Soldering

1. When sudden heat is applied to the components, the mechanical strength of the components will decrease because a sudden temperature change causes deformation inside the components. In order to prevent mechanical damage to the components, preheating is required for both the components and the PCB board. Preheating conditions are shown in table 1. It is required to keep the temperature differential between the solder and the component's surface (ΔT) as small as possible.
2. Solderability of tin plating termination chips might be deteriorated when a low temperature soldering profile where the peak solder temperature is below the melting point of tin is used. Please confirm the solderability of tin plated termination chips before use.
3. When components are immersed in solvent after mounting, be sure to maintain the temperature difference (ΔT) between the component and the solvent within the range shown in the table 1.

Table 1

| Part Number | Temperature Differential |
|--|-----------------------------------|
| GRM02/03/15/18/21/31 GJM02/03/15 LLL15/18/21/31 LLR18 GQM18/21 | $\Delta T \leq 190^\circ\text{C}$ |
| GRM32/43/55 LLA18/21/31 LLM21/31 GNM GQM22 | $\Delta T \leq 130^\circ\text{C}$ |

Recommended Conditions

| | Pb-Sn Solder | | Lead Free Solder |
|------------------|-----------------|--------------|-----------------------|
| | Infrared Reflow | Vapor Reflow | |
| Peak Temperature | 230 to 250°C | 230 to 240°C | 240 to 260°C |
| Atmosphere | Air | Air | Air or N ₂ |

Pb-Sn Solder: Sn-37Pb
 Lead Free Solder: Sn-3.0Ag-0.5Cu

4. Optimum Solder Amount for Reflow Soldering

- 4-1. Overly thick application of solder paste results in a excessive solder fillet height. This makes the chip more susceptible to mechanical and thermal stress on the board and may cause the chips to crack.
- 4-2. Too little solder paste results in a lack of adhesive strength on the outer electrode, which may result in chips breaking loose from the PCB.
- 4-3. Make sure the solder has been applied smoothly to the end surface to a height of 0.2mm* min.

Inverting the PCB

Make sure not to impose any abnormal mechanical shocks to the PCB.

[Standard Conditions for Reflow Soldering]

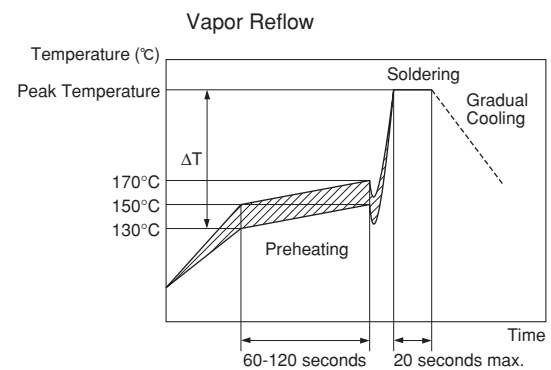
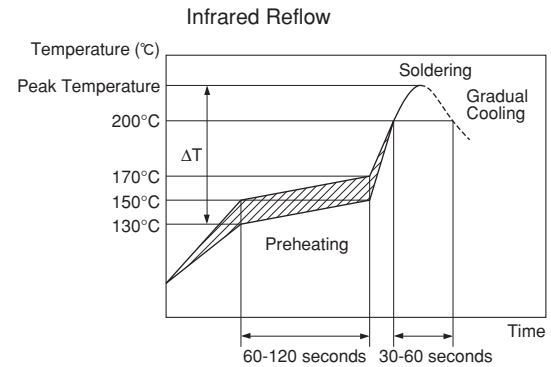

[Allowable Reflow Soldering Temperature and Time]

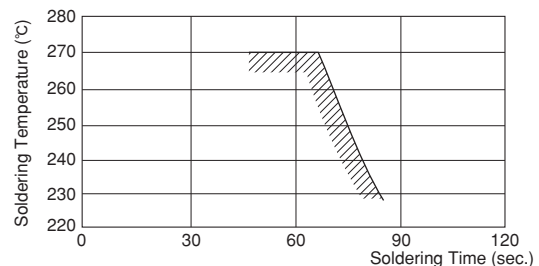

In the case of repeated soldering, the accumulated soldering time must be within the range shown above.

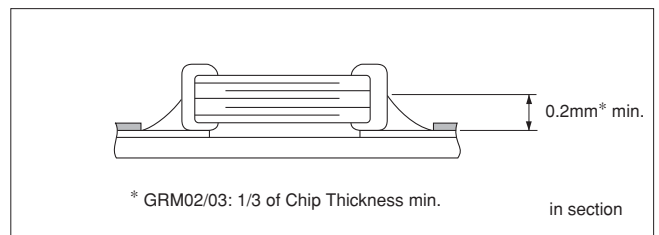

For General Purpose GRM Series
 Capacitor Array GNM Series
 Low ESL LLL Series
 High-Q Type GJM Series
 High Frequency GQM Series
 Monolithic Microchip GMA Series
 For Bonding GMD Series
 Product Information ⚠Caution

⚠Caution

☞ Continued from the preceding page.

4-2. Flow Soldering

1. When sudden heat is applied to the components, the mechanical strength of the components will decrease because a sudden temperature change causes deformation inside the components. In order to prevent mechanical damage in the components, preheating should be required for both of the components and the PCB board.
 Preheating conditions are shown in table 2. It is required to keep the temperature differential between the solder and the component's surface (ΔT) as small as possible.
2. Excessively long soldering time or high soldering temperature can result in leaching of the outer electrodes, causing poor adhesion or a reduction in capacitance value due to loss of contact between electrodes and end termination.
3. When components are immersed in solvent after mounting, be sure to maintain the temperature difference (ΔT) between the component and solvent within the range shown in the table 2.
4. Do not apply flow soldering to chips not listed in table 2.

Table 2

| Part Number | Temperature Differential |
|-------------|-------------------------------------|
| GRM18/21/31 | $\Delta T \leq 150^{\circ}\text{C}$ |
| LLL21/31 | |
| GQM18/21 | |

Recommended Conditions

| | Pb-Sn Solder | Lead Free Solder |
|-----------------------------|--------------|------------------|
| Preheating Peak Temperature | 90 to 110°C | 100 to 120°C |
| Soldering Peak Temperature | 240 to 250°C | 250 to 260°C |
| Atmosphere | Air | N ₂ |

Pb-Sn Solder: Sn-37Pb

Lead Free Solder: Sn-3.0Ag-0.5Cu

5. Optimum Solder Amount for Flow Soldering

- 5-1. The top of the solder fillet should be lower than the thickness of components. If the solder amount is excessive, the risk of cracking is higher during board bending or any other stressful condition.

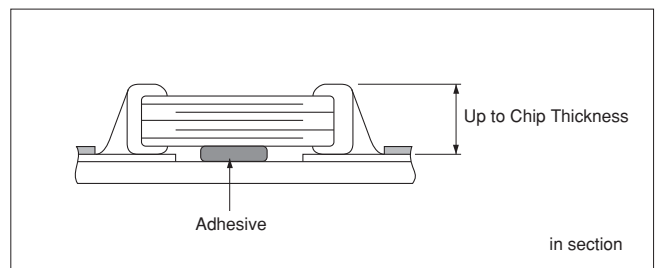
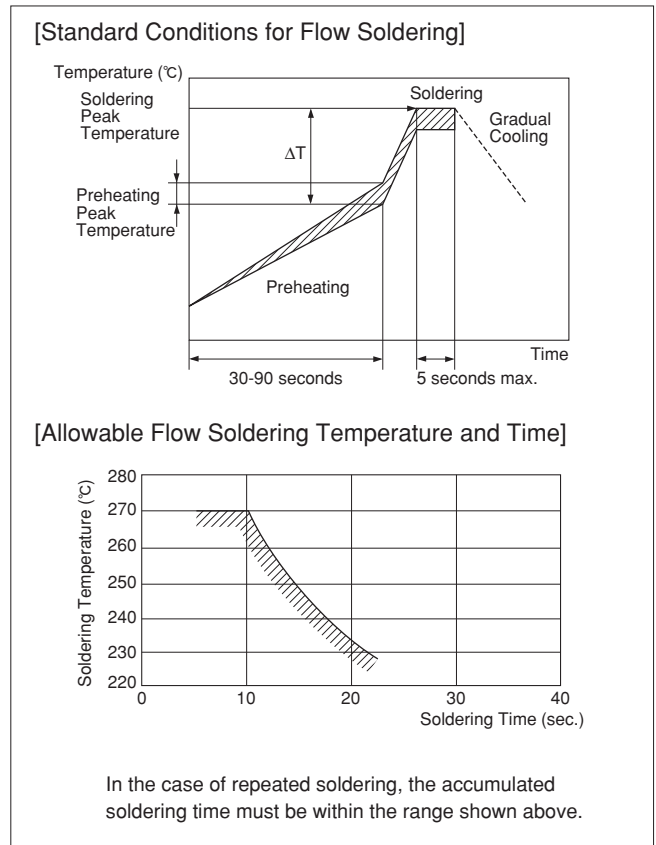

Continued on the following page. ☞

For General Purpose
GRM Series

Capacitor Array
GJM Series

Low ESL
LLC Series

High-Q Type
GJM Series

High Frequency
GQM Series

Monolithic Microchip
GMA Series

For Bonding
GMD Series

Product Information
⚠Caution

⚠Caution

☐ Continued from the preceding page.

4-3. Correction with a Soldering Iron

1. When sudden heat is applied to the components when using a soldering iron, the mechanical strength of the components will decrease because the extreme temperature change can cause deformations inside the components. In order to prevent mechanical damage to the components, preheating is required for both the components and the PCB board. Preheating conditions (The "Temperature of the Soldering Iron Tip", "Preheating Temperature," "Temperature Differential" between the iron tip and the components and the PCB), should be within the conditions of table 3. It is required to keep the temperature differential between the soldering iron and the component surfaces (ΔT) as small as possible.
2. After soldering, do not allow the component/PCB to cool down rapidly.
3. The operating time for the re-working should be as short as possible. When re-working time is too long, it may cause solder leaching, in turn causing a reduction in the adhesive strength of the terminations.
4. Optimum solder amount when re-working with a soldering iron
 - 4-1. For sizes smaller than 0603, (GRM03/15/18, GJM03/15, GQM18), the top of the solder fillet should be lower than $\frac{2}{3}$ of the thickness of the component or 0.5mm whichever is smaller. For 0805 and larger sizes, (GRM21/31/32/43/55, GQM21/22), the top of the solder fillet should be lower than $\frac{2}{3}$ of the thickness of the component. If the solder amount is excessive, the risk of cracking is higher during board bending or under any other stressful condition.
 - 4-2. A soldering iron with a tip of $\phi 3\text{mm}$ or smaller should be used. It is also necessary to keep the soldering iron from touching the components during the re-work.
 - 4-3. Solder wire with $\phi 0.5\text{mm}$ or smaller is required for soldering.

4-4. Leaded Component Insertion

1. If the PCB is flexed when leaded components (such as transformers and ICs) are being mounted, chips may crack and solder joints may break.
 Before mounting leaded components, support the PCB using backup pins or special jigs to prevent warping.

5. Washing

Excessive ultrasonic oscillation during cleaning can cause the PCBs to resonate, resulting in cracked chips or broken solder joints. Take note not to vibrate PCBs.

Table 3

| Part Number | Temperature of Soldering Iron Tip | Preheating Temperature | Temperature Differential (ΔT) | Atmosphere |
|---|-----------------------------------|------------------------|---|------------|
| GRM03/15/18/21/31 GJM03/15 GQM18/21 | 350°C max. | 150°C min. | $\Delta T \leq 190^\circ\text{C}$ | Air |
| GRM32/43/55 GQM22 | 280°C max. | 150°C min. | $\Delta T \leq 130^\circ\text{C}$ | Air |

*Applicable for both Pb-Sn and Lead Free Solder.
 Pb-Sn Solder: Sn-37Pb
 Lead Free Solder: Sn-3.0Ag-0.5Cu

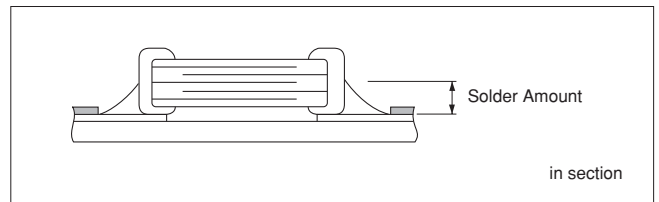

Continued on the following page. ☐

For General Purpose GRM Series
 Capacitor Array GNM Series
 Low ESL LL Series
 High-Q Type GJM Series
 High Frequency GQM Series
 Monolithic Microchip GMA Series
 For Bonding GMD Series
 Product Information ⚠Caution

⚠Caution

☐ Continued from the preceding page.

6. Electrical Test on Printed Circuit Board

1. Confirm position of the support pin or specific jig, when inspecting the electrical performance of a capacitor after mounting on the printed circuit board.

1-1. Avoid bending the printed circuit board by the pressure of a test pin, etc.

The thrusting force of the test probe can flex the PCB, resulting in cracked chips or open solder joints. Provide support pins on the back side of the PCB to prevent warping or flexing.

1-2. Avoid vibration of the board by shock when a test pin contacts a printed circuit board.

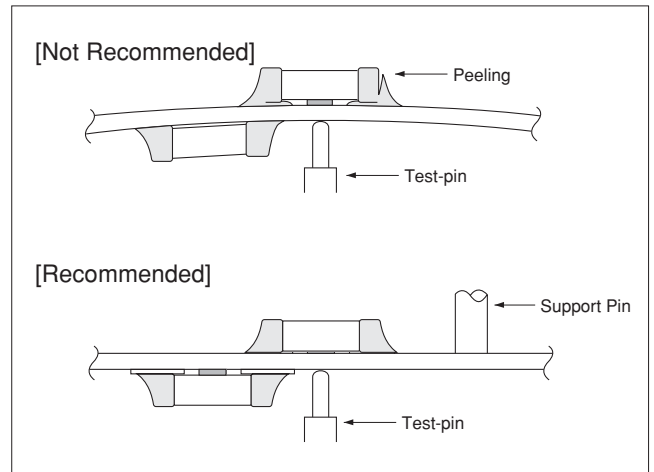

7. Printed Circuit Board Cropping

1. After mounting a capacitor on a printed circuit board, do not apply any stress to the capacitor that is caused by bending or twisting the board.

1-1. In cropping the board, the stress as shown at right may cause the capacitor to crack.

Try not to apply this type of stress to a capacitor.

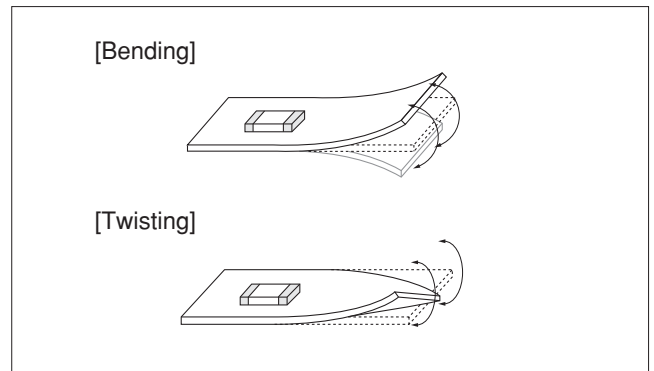

2. Ascertain of the cropping method for the printed circuit board in advance.

2-1. Printed circuit board cropping shall be carried out by using a jig or an apparatus to prevent the mechanical stress that can occur to the board.

(1) Example of a suitable jig

Recommended example: the board should be pushed as close to the cropping jig as possible and from the back side of board in order to minimize the compressive stress applied to the capacitor.

Not recommended example: when the board is pushed at a point far from the cropping jig and from the front side of board as below, the capacitor may form a crack caused by the tensile stress applied to capacitor.

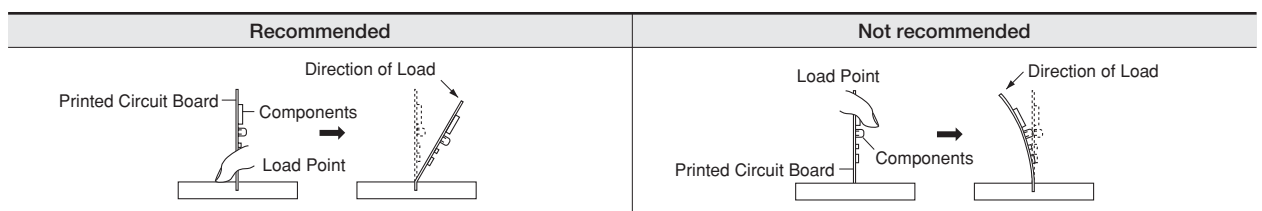
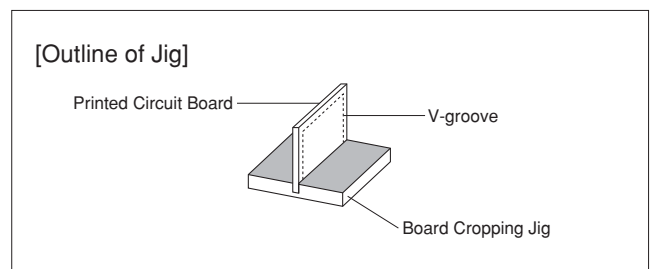

Continued on the following page. ☐

For General Purpose
GRM Series

Capacitor Array
GNM Series

Low ESL
LL□ Series

High-Q Type
GJM Series

High Frequency
GQM Series

Monolithic Microchip
GMA Series

For Bonding
GMD Series

Product Information
⚠Caution

⚠Caution

Continued from the preceding page.

(2) Example of a suitable machine

An outline of a printed circuit board cropping machine is shown as follows. Along the lines with the V-grooves on the printed circuit board, the top and bottom blades are aligned to one another when cropping the board.

The misalignment of the position between top and bottom blades may cause the capacitor to crack.

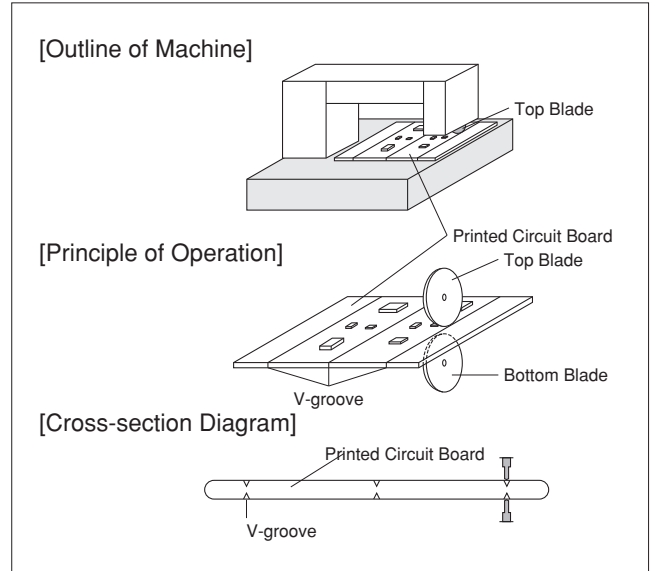

| Recommended | Not Recommended | | |
|--------------------------------------|--------------------------------------|--------------------------------------|--------------------------------------|
| | Top-bottom Misalignment | Left-right Misalignment | Front-rear Misalignment |
| <p>Top Blade</p> <p>Bottom Blade</p> | <p>Top Blade</p> <p>Bottom Blade</p> | <p>Top Blade</p> <p>Bottom Blade</p> | <p>Top Blade</p> <p>Bottom Blade</p> |

■ Others

1. Under Operation of Equipment

- 1-1. Do not touch a capacitor directly with bare hands during operation in order to avoid the danger of an electric shock.
- 1-2. Do not allow the terminals of a capacitor to come in contact with any conductive objects (short-circuit). Do not expose a capacitor to a conductive liquid, including any acid or alkali solutions.
- 1-3. Confirm the environment in which the equipment will operate is under the specified conditions. Do not use the equipment under the following environments.
 - (1) Being spattered with water or oil.
 - (2) Being exposed to direct sunlight.
 - (3) Being exposed to Ozone, ultraviolet rays or radiation.
 - (4) Being exposed to toxic gas (e.g., hydrogen sulfide, sulfur dioxide, chlorine, ammonia gas, etc.)
 - (5) Any vibrations or mechanical shocks exceeding the specified limits.
 - (6) Moisture condensing environments.
- 1-4. Use damp proof countermeasures if using under any conditions that can cause condensation.

2. Others

- 2-1. In an Emergency
 - (1) If the equipment should generate smoke, fire or smell, immediately turn off or unplug the equipment.

If the equipment is not turned off or unplugged, the hazards may be worsened by supplying continuous power.

- (2) In this type of situation, do not allow face and hands to come in contact with the capacitor or burns may be caused by the capacitor's high temperature.

2-2. Disposal of Waste

When capacitors are disposed, they must be burned or buried by an industrial waste vendor with the appropriate licenses.

2-3. Circuit Design

GRM, GCM, GMA/D, LLL/A/M, GQM, GJM, GNM Series capacitors in this catalog are not safety certified products.

2-4. Remarks

Failure to follow the cautions may result, worst case, in a short circuit and smoking when the product is used.

The above notices are for standard applications and conditions. Contact us when the products are used in special mounting conditions.

Select optimum conditions for operation as they determine the reliability of the product after assembly. The data herein are given in typical values, not guaranteed ratings.

For General Purpose GRM Series
 Capacitor Array GNM Series
 Low ESL LLL Series
 High-Q Type GJM Series
 High Frequency GQM Series
 Monolithic Microchip GMA Series
 For Bonding GMD Series
 Product Information ⚠Caution

Notice

Rating

1. Operating Temperature

1. The operating temperature limit depends on the capacitor.

1-1. Do not apply temperatures exceeding the upper operating temperature.

It is necessary to select a capacitor with a suitable rated temperature that will cover the operating temperature range.

It is also necessary to consider the temperature distribution in equipment and the seasonal temperature variable factor.

1-2. Consider the self-heating factor of the capacitor.

The surface temperature of the capacitor shall be the upper operating temperature or less when including the self-heating factors.

2. Atmosphere Surroundings (gaseous and liquid)

1. Restriction on the operating environment of capacitors.

1-1. Capacitors, when used in the above, unsuitable,

operating environments may deteriorate due to the corrosion of the terminations and the penetration of moisture into the capacitor.

1-2. The same phenomenon as the above may occur when the electrodes or terminals of the capacitor are subject to moisture condensation.

1-3. The deterioration of characteristics and insulation resistance due to the oxidization or corrosion of terminal electrodes may result in breakdown when the capacitor is exposed to corrosive or volatile gases or solvents for long periods of time.

3. Piezo-electric Phenomenon

1. When using high dielectric constant type capacitors in AC or pulse circuits, the capacitor itself vibrates at specific frequencies and noise may be generated. Moreover, when the mechanical vibration or shock is added to the capacitor, noise may occur.

Soldering and Mounting

1. PCB Design

1. Notice for Pattern Forms



1-1. Unlike leaded components, chip components are susceptible to flexing stresses since they are mounted directly on the substrate.

They are also more sensitive to mechanical and thermal stresses than leaded components.

Excess solder fillet height can multiply these stresses and cause chip cracking. When designing substrates, take land patterns and dimensions into consideration to eliminate the possibility of excess solder fillet height.

1-2. There is a possibility of chip crack caused by PCB expansion/contraction with heat. Because stress for chip is different depend on PCB material and structure. Especially metal PCB such as alumina has a greater risk of chip crack because of large difference of thermal expansion coefficient. In case of chip below 0402 size, there is also the same possibility of crack with a single-layered glass epoxy board.

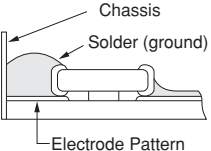
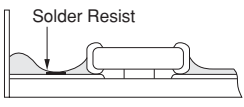
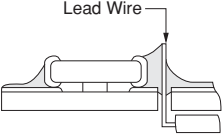
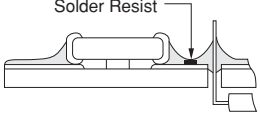
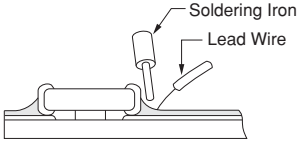
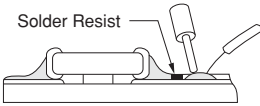
Pattern Forms

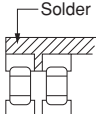
| | Prohibited | Correct |
|---|---|---|
| Placing Close to Chassis |  |  |
| Placing of Chip Components and Leaded Components |  |  |
| Placing of Leaded Components after Chip Component |  |  |
| Lateral Mounting |  |  |

Continued on the following page. ↗

For General Purpose
GRM Series

Capacitor Array
GNM Series

Low ESL
LL□ Series

High-Q Type
GJM Series

High Frequency
GQM Series

Monolithic Microchip
GMA Series

For Bonding
GMD Series

Product Information
Notice

Notice

☐ Continued from the preceding page.

2. Land Dimensions

2-1. A chip capacitor can be cracked due to the stress of PCB bending, etc. if the land area is larger than needed and has an excess amount of solder. Please refer to the land dimensions in table 1 for flow soldering, table 2 for reflow soldering, table 3 for GNM & LLA, and table 4 for LLM. Please confirm the suitable land dimension by evaluating the actual SET / PCB.

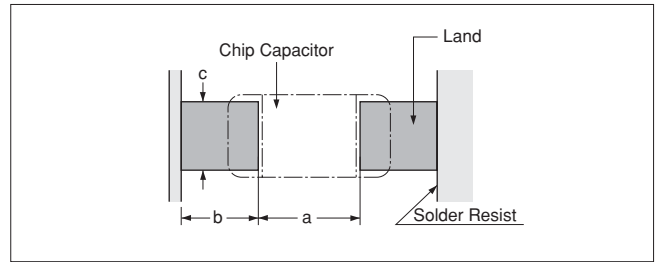

Table 1 Flow Soldering Method

| Part Number | Dimensions | Chip (L×W) | a | b | c |
|----------------|------------|------------|------------|------------|------------|
| GRM18 GQM18 | | 1.6×0.8 | 0.6 to 1.0 | 0.8 to 0.9 | 0.6 to 0.8 |
| GRM21 GQM21 | | 2.0×1.25 | 1.0 to 1.2 | 0.9 to 1.0 | 0.8 to 1.1 |
| GRM31 LLL21 | | 3.2×1.6 | 2.2 to 2.6 | 1.0 to 1.1 | 1.0 to 1.4 |
| LLL31 | | 1.25×2.0 | 0.4 to 0.7 | 0.5 to 0.7 | 1.4 to 1.8 |
| | | 1.6×3.2 | 0.6 to 1.0 | 0.8 to 0.9 | 2.6 to 2.8 |

(in mm)

Table 2 Reflow Soldering Method

| Part Number | Dimensions | Chip (L×W) | a | b | c |
|----------------|------------|------------------------|-------------|--------------|-------------|
| GRM02 GJM02 | | 0.4×0.2 | 0.16 to 0.2 | 0.12 to 0.18 | 0.2 to 0.23 |
| GRM03 GJM03 | | 0.6×0.3 | 0.2 to 0.3 | 0.2 to 0.35 | 0.2 to 0.4 |
| GRM15 GJM15 | | 1.0×0.5 (within ±0.10) | 0.3 to 0.5 | 0.35 to 0.45 | 0.4 to 0.6 |
| | | 1.0×0.5 (±0.15/±0.20) | 0.4 to 0.6 | 0.40 to 0.50 | 0.5 to 0.7 |
| GRM18 GQM18 | | 1.6×0.8 (within ±0.10) | 0.6 to 0.8 | 0.6 to 0.7 | 0.6 to 0.8 |
| | | 1.6×0.8 (±0.15/±0.20) | 0.7 to 0.9 | 0.7 to 0.8 | 0.8 to 1.0 |
| GQM21 | | 2.0×1.25 | 1.0 to 1.2 | 0.6 to 0.7 | 0.8 to 1.1 |
| GRM21 | | 2.0×1.25 (within ±1.0) | 1.2 | 0.6 | 1.25 |
| | | 2.0×1.25 (±0.15) | 1.2 | 0.6 to 0.8 | 1.2 to 1.4 |
| | | 2.0×1.25 (±0.20) | 1.0 to 1.4 | 0.6 to 0.8 | 1.2 to 1.4 |
| GRM31 | | 3.2×1.6 (within ±0.20) | 1.8 to 2.0 | 0.9 to 1.2 | 1.5 to 1.7 |
| | | 3.2×1.6 (±0.30) | 1.9 to 2.1 | 1.0 to 1.3 | 1.7 to 1.9 |
| GRM32 | | 3.2×2.5 | 2.0 to 2.4 | 1.0 to 1.2 | 1.8 to 2.3 |
| GRM43 | | 4.5×3.2 | 3.0 to 3.5 | 1.2 to 1.4 | 2.3 to 3.0 |
| GRM55 | | 5.7×5.0 | 4.0 to 4.6 | 1.4 to 1.6 | 3.5 to 4.8 |
| LLL15 | | 0.5×1.0 | 0.15 to 0.2 | 0.2 to 0.25 | 0.7 to 1.0 |
| LLL18 LLR18 | | 0.8×1.6 | 0.2 to 0.3 | 0.3 to 0.4 | 1.4 to 1.6 |
| | | 1.25×2.0 | 0.4 to 0.6 | 0.4 to 0.5 | 1.4 to 1.8 |
| LLL31 | | 1.6×3.2 | 0.6 to 0.8 | 0.6 to 0.7 | 2.6 to 2.8 |
| GQM22 | | 2.8×2.8 | 2.2 to 2.5 | 0.8 to 1.0 | 1.9 to 2.3 |

(in mm)

Continued on the following page. ☐

For General Purpose GRM Series
 Capacitor Array GNM Series
 Low ESL LLL Series
 High-Q Type GJM Series
 High Frequency GQM Series
 Monolithic Microchip GMA Series
 For Bonding GMD Series
 Product Information Notice

Notice

Continued from the preceding page.

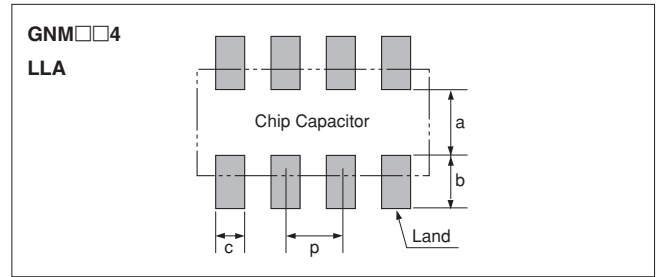
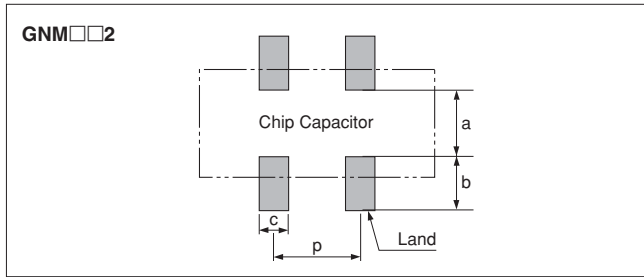

Table 3 GNM, LLA Series for Reflow Soldering Land Dimensions

| Part Number | Dimensions (mm) | | | | | |
|-------------|-----------------|------|---------------|---------------|--------------|------|
| | L | W | a | b | c | p |
| GNM0M2 | 0.9 | 0.6 | 0.12 to 0.20* | 0.35 to 0.40* | 0.3 | 0.45 |
| GNM1M2 | 1.37 | 1.0 | 0.4 to 0.5 | 0.35 to 0.45 | 0.3 to 0.35 | 0.64 |
| GNM212 | 2.0 | 1.25 | 0.6 to 0.7 | 0.5 to 0.7 | 0.4 to 0.5 | 1.0 |
| GNM214 | 2.0 | 1.25 | 0.6 to 0.7 | 0.5 to 0.7 | 0.25 to 0.35 | 0.5 |
| GNM314 | 3.2 | 1.6 | 0.8 to 1.0 | 0.7 to 0.9 | 0.3 to 0.4 | 0.8 |
| LLA18 | 1.6 | 0.8 | 0.3 to 0.4 | 0.25 to 0.35 | 0.15 to 0.25 | 0.4 |
| LLA21 | 2.0 | 1.25 | 0.5 to 0.7 | 0.35 to 0.6 | 0.2 to 0.3 | 0.5 |
| LLA31 | 3.2 | 1.6 | 0.7 to 0.9 | 0.4 to 0.7 | 0.3 to 0.4 | 0.8 |

* $0.82 \leq a+2b \leq 1.00$

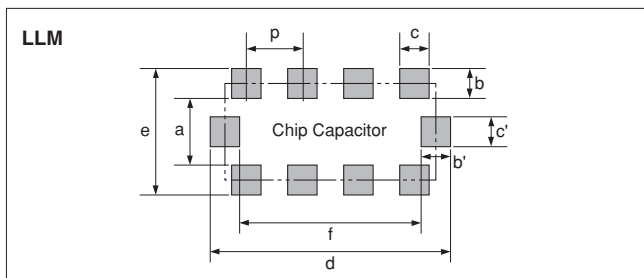

Table 4 LLM Series for Reflow Soldering Land Dimensions

| Part Number | Dimensions (mm) | | | | | | |
|-------------|-----------------|--------------|-------|------------|------------|------------|-----|
| | a | b, b' | c, c' | d | e | f | p |
| LLM21 | 0.6 to 0.8 | (0.3 to 0.5) | 0.3 | 2.0 to 2.6 | 1.3 to 1.8 | 1.4 to 1.6 | 0.5 |
| LLM31 | 1.0 | (0.3 to 0.5) | 0.4 | 3.2 to 3.6 | 1.6 to 2.0 | 2.6 | 0.8 |

$b=(c-e)/2, b'=(d-f)/2$

2. Adhesive Application

- Thin or insufficient adhesive can cause the chips to loosen or become disconnected during flow soldering. The amount of adhesive must be more than dimension c, shown in the drawing at right, to obtain the correct bonding strength. The chip's electrode thickness and land thickness must also be taken into consideration.
- Low viscosity adhesive can cause chips to slip after mounting. The adhesive must have a viscosity of 5000Pa · s (500ps) min. (at 25°C).
- Adhesive Coverage

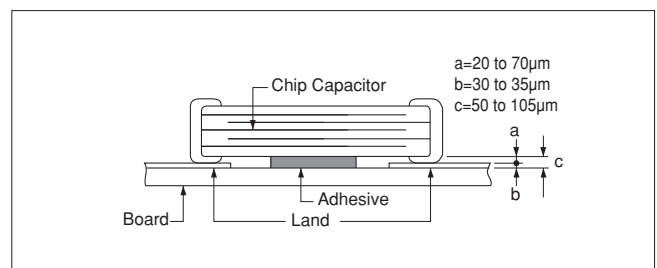

| Part Number | Adhesive Coverage* |
|---------------------|--------------------|
| GRM18, GQM18 | 0.05mg min. |
| GRM21, LLL21, GQM21 | 0.1mg min. |
| GRM31, LLL31 | 0.15mg min. |

*Nominal Value

Continued on the following page. ↗

For General Purpose GRM Series

Capacitor Array GNM Series

Low ESL LLL Series

High-Q Type GJM Series

High Frequency GQM Series

Monolithic Microchip GMA Series

For Bonding GMD Series

Product Information Notice

Notice

☞ Continued from the preceding page.

3. Adhesive Curing

1. Insufficient curing of the adhesive can cause chips to disconnect during flow soldering and deterioration in the insulation resistance between the outer electrodes due to moisture absorption.

Control curing temperature and time in order to prevent insufficient hardening.

4. Flux Application

1. An excessive amount of flux generates a large quantity of flux gas, which can cause a deterioration of solderability, so apply flux thinly and evenly throughout. (A foaming system is generally used for flow soldering.)
2. Flux containing too high a percentage of halide may cause corrosion of the outer electrodes unless there is sufficient cleaning. Use flux with a halide content of 0.2% max.

5. Flow Soldering

- Set temperature and time to ensure that leaching of the outer electrode does not exceed 25% of the chip end area as a single chip (full length of the edge A-B-C-D shown at right) and 25% of the length A-B shown as mounted on substrate.

3. Do not use strong acidic flux.

4. Do not use water-soluble *flux.

(*Water-soluble flux can be defined as non-rosin type flux including wash-type flux and non-wash-type flux.)

[As a Single Chip]

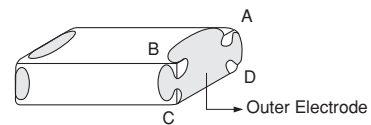

[As Mounted on Substrate]

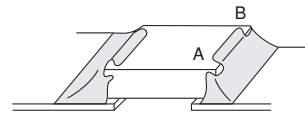

6. Washing

1. Please evaluate a capacitor using actual cleaning equipment and conditions to confirm the quality and select the applicable solvent.
2. Unsuitable cleaning solvent may leave residual flux or other foreign substances, causing deterioration of electrical characteristics and the reliability of the capacitors.

3. Select the proper cleaning conditions.

3-1. Improper cleaning conditions (excessive or insufficient) may result in the deterioration of the performance of the capacitors.

Continued on the following page. ☞

Notice

☐ Continued from the preceding page.

7. Coating

1. A crack may be caused in the capacitor due to the stress of the thermal contraction of the resin during curing process.

The stress is affected by the amount of resin and curing contraction.

Select a resin with low curing contraction.

The difference in the thermal expansion coefficient between a coating resin or a molding resin and the capacitor may cause the destruction and deterioration of the capacitor such as a crack or peeling, and lead to the deterioration of insulation resistance or dielectric breakdown.

Select a resin for which the thermal expansion coefficient is as close to that of the capacitor as possible.
A silicone resin can be used as an under-coating to buffer against the stress.

2. Select a resin that is less hygroscopic.
Using hygroscopic resins under high humidity conditions may cause the deterioration of the insulation resistance of a capacitor.

An epoxy resin can be used as a less hygroscopic resin.

8. Die Bonding/Wire Bonding (GMA or GMD Series)

1. Die Bonding of Capacitors

• Use the following materials for the Brazing alloys:

Au-Sn (80/20) 300 to 320 °C in N₂ atmosphere

• Mounting

(1) Control the temperature of the substrate so it matches the temperature of the brazing alloy.

(2) Place the brazing alloy on the substrate and place the capacitor on the alloy. Hold the capacitor and gently apply the load. Be sure to complete the operation within 1 minute.

2. Wire Bonding

• Wire

Gold wire: 25 micro m (0.001 inch) diameter

• Bonding

(1) Thermo compression, ultrasonic ball bonding.

(2) Required stage temperature: 150 to 200 °C

(3) Required wedge or capillary weight: 0.2N to 0.5N

(4) Bond the capacitor and base substrate or other devices with gold wire.

■ Others

1. Transportation

1. The performance of a capacitor may be affected by the conditions during transportation.

1-1. The capacitors shall be protected against excessive temperature, humidity and mechanical force during transportation.

(1) Climatic condition

• low air temperature: -40°C

• change of temperature air/air: -25°C/+25°C

• low air pressure: 30 kPa

• change of air pressure: 6 kPa/min.

(2) Mechanical condition

Transportation shall be done in such a way that the boxes are not deformed and forces are not directly passed on to the inner packaging.

1-2. Do not apply excessive vibration, shock, and pressure to the capacitor.

(1) When excessive mechanical shock or pressure is applied to a capacitor, chipping or cracking may occur in the ceramic body of the capacitor.

(2) When the sharp edge of an air driver, a soldering iron, tweezers, a chassis, etc. impacts strongly on the surface of the capacitor, the capacitor may crack and short-circuit.

1-3. Do not use a capacitor to which excessive shock was applied by dropping, etc.

A capacitor dropped accidentally during processing may be damaged.

For General Purpose
GRM Series

Capacitor Array
GNM Series

Low ESL
LL□ Series

High-Q Type
GJM Series

High Frequency
GQM Series

Monolithic Microchip
GMA Series

For Bonding
GMD Series

Product Information
Notice

MEMO

Contents

Chip Monolithic Ceramic Capacitors (Medium Voltage)

For General Purpose

GRM (250Vdc min.)/GRJ/GR3 Series

| | |
|--------------------------------------|------|
| Temperature Compensating Type | |
| GRM Series (250Vdc min.) | p136 |
| High Dielectric Constant Type | |
| GRM Series (250Vdc min.) | p143 |
| Soft Termination Type GRJ Series | p148 |
| Large Capacitance and High Allowable | |
| Ripple Current GR3 Series | p153 |

Only for Applications

| | |
|-------------------------------------|------|
| For LCD Backlight Inverter Circuit | |
| GRM/DC3.15kV Series | p158 |
| For Information Devices GR4 Series | p161 |
| For Camera Flash Circuit GR7 Series | p165 |

AC250V Type (Which Meet Japanese Law)

| | |
|------------|------|
| GA2 Series | p169 |
|------------|------|

Safety Standard Certified GA3 Series

| | |
|-------------------------------------|------|
| UL, IEC60384-14 Class X1/Y2 Type GC | p173 |
| IEC60384-14 Class Y2, X1/Y2 Type GF | p174 |
| IEC60384-14 Class Y3 Type GD | p176 |
| IEC60384-14 Class X2 Type GB | p177 |

| | |
|----------------------------------|------|
| Reference Data (Typical Example) | p182 |
|----------------------------------|------|

| | |
|---------|------|
| Package | p185 |
|---------|------|

| | |
|-----------------|------|
| ⚠Caution/Notice | p188 |
|-----------------|------|

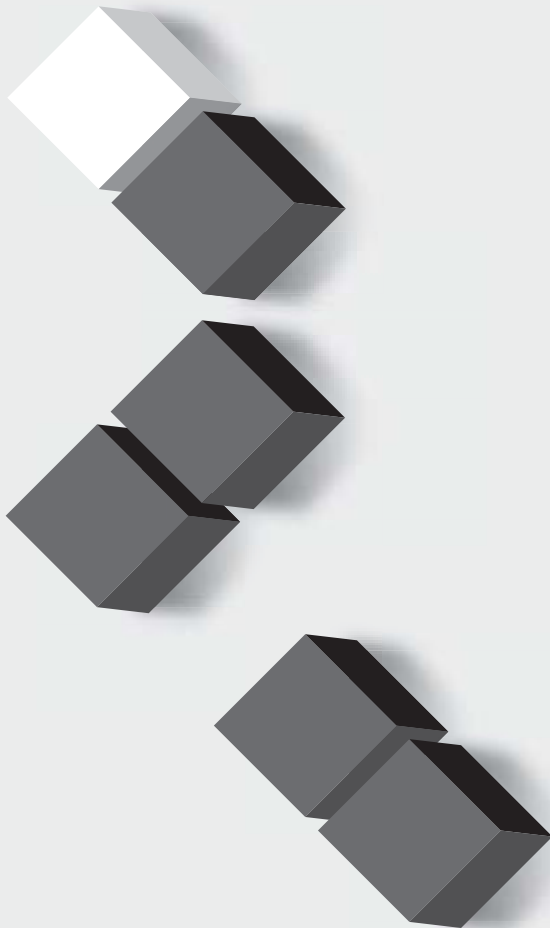

For General Purpose
 GRM/GRJ/GR3 Series

Only for Applications

AC250V Type
 GA2 Series

Safety Standard
 Certified GA3 Series

Product Information

Chip Monolithic Ceramic Capacitors (Medium Voltage)

Temperature Compensating Type GRM Series (250Vdc min.)

■ Features

1. Low-loss and suitable for high frequency circuits
2. Murata's original internal electrode structure provides high flash-over voltage.
3. A new monolithic structure for small, surface-mountable devices capable of operating at high voltage levels
4. Sn-plated external electrodes provides good solderability.
5. Use the GRM21/31 type with flow or reflow soldering, and other types with reflow soldering only.

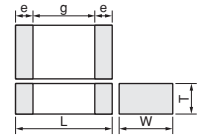

| Part Number | Dimensions (mm) | | | | |
|-------------|-----------------|-----------|-----------------|--------|--------|
| | L | W | T | e min. | g min. |
| GRM21A | 2.0 ±0.2 | 1.25 ±0.2 | 1.0 +0.0, -0.3 | 0.3 | 1.5* |
| GRM21B | | | 1.25 ±0.2 | | |
| GRM31A | 3.2 ±0.2 | 1.6 ±0.2 | 1.0 +0.0, -0.3 | | |
| GRM31B | | | 1.25 +0.0, -0.3 | | |
| GRM31C | | | 1.6 ±0.2 | | |
| GRM32A | 3.2 ±0.2 | 2.5 ±0.2 | 1.0 +0.0, -0.3 | | |
| GRM32B | | | 1.25 +0.0, -0.3 | | |
| GRM32Q | | | 1.5 +0.0, -0.3 | | |
| GRM32D | | | 2.0 +0.0, -0.3 | | |
| GRM42A | 4.5 ±0.3 | 2.0 ±0.2 | 1.0 +0.0, -0.3 | | |
| GRM43Q | 4.5 ±0.4 | 3.2 ±0.3 | 1.5 +0.0, -0.3 | 2.2 | |
| GRM43D | 5.7 ±0.4 | 5.0 ±0.4 | 2.0 +0.0, -0.3 | 3.2 | |
| GRM55Q | | | 1.5 +0.0, -0.3 | | |
| GRM55D | | | 2.0 +0.0, -0.3 | | |

* GRM31A7U3D, GRM32A7U3D, GRM32B7U3D: 1.8mm min.

■ Applications

Ideal for use on high frequency pulse circuits such as snubber circuits for switching power supplies, DC-DC converters, ballasts (inverter fluorescent lamps), etc.

Do not use these products in any Automotive Power train or Safety equipment including Battery chargers for Electric Vehicles and Plug-in Hybrids. Only Murata products clearly stipulated as "for Automotive use" can be used for automobile applications such as Power train and Safety equipment.

C0G Characteristics

| Part Number | Rated Voltage | TC Code (Standard) | Capacitance | Length L (mm) | Width W (mm) | Thickness T max. (mm) | Electrode g min. | Electrode e |
|--------------------|---------------|--------------------|-------------|---------------|--------------|-----------------------|------------------|-------------|
| GRM21A5C2E100JW01D | 250Vdc | C0G (EIA) | 10pF±5% | 2 | 1.25 | 1 | 0.7mm | 0.3mm min. |
| GRM21A5C2E120JW01D | 250Vdc | C0G (EIA) | 12pF±5% | 2 | 1.25 | 1 | 0.7mm | 0.3mm min. |
| GRM21A5C2E150JW01D | 250Vdc | C0G (EIA) | 15pF±5% | 2 | 1.25 | 1 | 0.7mm | 0.3mm min. |
| GRM21A5C2E180JW01D | 250Vdc | C0G (EIA) | 18pF±5% | 2 | 1.25 | 1 | 0.7mm | 0.3mm min. |
| GRM21A5C2E220JW01D | 250Vdc | C0G (EIA) | 22pF±5% | 2 | 1.25 | 1 | 0.7mm | 0.3mm min. |
| GRM21A5C2E270JW01D | 250Vdc | C0G (EIA) | 27pF±5% | 2 | 1.25 | 1 | 0.7mm | 0.3mm min. |
| GRM21A5C2E330JW01D | 250Vdc | C0G (EIA) | 33pF±5% | 2 | 1.25 | 1 | 0.7mm | 0.3mm min. |
| GRM21A5C2E390JW01D | 250Vdc | C0G (EIA) | 39pF±5% | 2 | 1.25 | 1 | 0.7mm | 0.3mm min. |
| GRM21A5C2E470JW01D | 250Vdc | C0G (EIA) | 47pF±5% | 2 | 1.25 | 1 | 0.7mm | 0.3mm min. |
| GRM21A5C2E560JW01D | 250Vdc | C0G (EIA) | 56pF±5% | 2 | 1.25 | 1 | 0.7mm | 0.3mm min. |
| GRM21A5C2E680JW01D | 250Vdc | C0G (EIA) | 68pF±5% | 2 | 1.25 | 1 | 0.7mm | 0.3mm min. |
| GRM21A5C2E820JW01D | 250Vdc | C0G (EIA) | 82pF±5% | 2 | 1.25 | 1 | 0.7mm | 0.3mm min. |
| GRM21A5C2E101JW01D | 250Vdc | C0G (EIA) | 100pF±5% | 2 | 1.25 | 1 | 0.7mm | 0.3mm min. |
| GRM21A5C2E121JW01D | 250Vdc | C0G (EIA) | 120pF±5% | 2 | 1.25 | 1 | 0.7mm | 0.3mm min. |
| GRM21A5C2E151JW01D | 250Vdc | C0G (EIA) | 150pF±5% | 2 | 1.25 | 1 | 0.7mm | 0.3mm min. |
| GRM21A5C2E181JW01D | 250Vdc | C0G (EIA) | 180pF±5% | 2 | 1.25 | 1 | 0.7mm | 0.3mm min. |
| GRM21A5C2E221JW01D | 250Vdc | C0G (EIA) | 220pF±5% | 2 | 1.25 | 1 | 0.7mm | 0.3mm min. |
| GRM21A5C2E271JW01D | 250Vdc | C0G (EIA) | 270pF±5% | 2 | 1.25 | 1 | 0.7mm | 0.3mm min. |
| GRM21A5C2E331JW01D | 250Vdc | C0G (EIA) | 330pF±5% | 2 | 1.25 | 1 | 0.7mm | 0.3mm min. |
| GRM31A5C2J100JW01D | 630Vdc | C0G (EIA) | 10pF±5% | 3.2 | 1.6 | 1 | 1.5mm | 0.3mm min. |
| GRM31A5C2J120JW01D | 630Vdc | C0G (EIA) | 12pF±5% | 3.2 | 1.6 | 1 | 1.5mm | 0.3mm min. |
| GRM31A5C2J150JW01D | 630Vdc | C0G (EIA) | 15pF±5% | 3.2 | 1.6 | 1 | 1.5mm | 0.3mm min. |
| GRM31A5C2J180JW01D | 630Vdc | C0G (EIA) | 18pF±5% | 3.2 | 1.6 | 1 | 1.5mm | 0.3mm min. |

Continued on the following page. ↗

Continued from the preceding page.

| Part Number | Rated Voltage | TC Code (Standard) | Capacitance | Length L (mm) | Width W (mm) | Thickness T max. (mm) | Electrode g min. | Electrode e |
|--------------------|---------------|--------------------|-------------|---------------|--------------|-----------------------|------------------|-------------|
| GRM31A5C2J220JW01D | 630Vdc | C0G (EIA) | 22pF±5% | 3.2 | 1.6 | 1 | 1.5mm | 0.3mm min. |
| GRM31A5C2J270JW01D | 630Vdc | C0G (EIA) | 27pF±5% | 3.2 | 1.6 | 1 | 1.5mm | 0.3mm min. |
| GRM31A5C2J330JW01D | 630Vdc | C0G (EIA) | 33pF±5% | 3.2 | 1.6 | 1 | 1.5mm | 0.3mm min. |
| GRM31A5C2J390JW01D | 630Vdc | C0G (EIA) | 39pF±5% | 3.2 | 1.6 | 1 | 1.5mm | 0.3mm min. |
| GRM31A5C2J470JW01D | 630Vdc | C0G (EIA) | 47pF±5% | 3.2 | 1.6 | 1 | 1.5mm | 0.3mm min. |
| GRM31A5C2J560JW01D | 630Vdc | C0G (EIA) | 56pF±5% | 3.2 | 1.6 | 1 | 1.5mm | 0.3mm min. |
| GRM31A5C2J680JW01D | 630Vdc | C0G (EIA) | 68pF±5% | 3.2 | 1.6 | 1 | 1.5mm | 0.3mm min. |
| GRM31A5C2J820JW01D | 630Vdc | C0G (EIA) | 82pF±5% | 3.2 | 1.6 | 1 | 1.5mm | 0.3mm min. |
| GRM31A5C2J101JW01D | 630Vdc | C0G (EIA) | 100pF±5% | 3.2 | 1.6 | 1 | 1.5mm | 0.3mm min. |
| GRM31A5C2J121JW01D | 630Vdc | C0G (EIA) | 120pF±5% | 3.2 | 1.6 | 1 | 1.5mm | 0.3mm min. |
| GRM31A5C2J151JW01D | 630Vdc | C0G (EIA) | 150pF±5% | 3.2 | 1.6 | 1 | 1.5mm | 0.3mm min. |
| GRM31A5C2J181JW01D | 630Vdc | C0G (EIA) | 180pF±5% | 3.2 | 1.6 | 1 | 1.5mm | 0.3mm min. |
| GRM31A5C2J221JW01D | 630Vdc | C0G (EIA) | 220pF±5% | 3.2 | 1.6 | 1 | 1.5mm | 0.3mm min. |
| GRM31A5C2J271JW01D | 630Vdc | C0G (EIA) | 270pF±5% | 3.2 | 1.6 | 1 | 1.5mm | 0.3mm min. |
| GRM31A5C2J331JW01D | 630Vdc | C0G (EIA) | 330pF±5% | 3.2 | 1.6 | 1 | 1.5mm | 0.3mm min. |
| GRM31A5C2J391JW01D | 630Vdc | C0G (EIA) | 390pF±5% | 3.2 | 1.6 | 1 | 1.5mm | 0.3mm min. |
| GRM31A5C2J471JW01D | 630Vdc | C0G (EIA) | 470pF±5% | 3.2 | 1.6 | 1 | 1.5mm | 0.3mm min. |
| GRM31A5C2J561JW01D | 630Vdc | C0G (EIA) | 560pF±5% | 3.2 | 1.6 | 1 | 1.5mm | 0.3mm min. |
| GRM31B5C2J681JW01L | 630Vdc | C0G (EIA) | 680pF±5% | 3.2 | 1.6 | 1.25 | 1.5mm | 0.3mm min. |
| GRM31B5C2J821JW01L | 630Vdc | C0G (EIA) | 820pF±5% | 3.2 | 1.6 | 1.25 | 1.5mm | 0.3mm min. |
| GRM31B5C2J102JW01L | 630Vdc | C0G (EIA) | 1000pF±5% | 3.2 | 1.6 | 1.25 | 1.5mm | 0.3mm min. |
| GRM31A5C3A100JW01D | 1000Vdc | C0G (EIA) | 10pF±5% | 3.2 | 1.6 | 1 | 1.5mm | 0.3mm min. |
| GRM31A5C3A120JW01D | 1000Vdc | C0G (EIA) | 12pF±5% | 3.2 | 1.6 | 1 | 1.5mm | 0.3mm min. |
| GRM31A5C3A150JW01D | 1000Vdc | C0G (EIA) | 15pF±5% | 3.2 | 1.6 | 1 | 1.5mm | 0.3mm min. |
| GRM31A5C3A180JW01D | 1000Vdc | C0G (EIA) | 18pF±5% | 3.2 | 1.6 | 1 | 1.5mm | 0.3mm min. |
| GRM31A5C3A220JW01D | 1000Vdc | C0G (EIA) | 22pF±5% | 3.2 | 1.6 | 1 | 1.5mm | 0.3mm min. |
| GRM31A5C3A270JW01D | 1000Vdc | C0G (EIA) | 27pF±5% | 3.2 | 1.6 | 1 | 1.5mm | 0.3mm min. |
| GRM31A5C3A330JW01D | 1000Vdc | C0G (EIA) | 33pF±5% | 3.2 | 1.6 | 1 | 1.5mm | 0.3mm min. |
| GRM31A5C3A390JW01D | 1000Vdc | C0G (EIA) | 39pF±5% | 3.2 | 1.6 | 1 | 1.5mm | 0.3mm min. |
| GRM31A5C3A470JW01D | 1000Vdc | C0G (EIA) | 47pF±5% | 3.2 | 1.6 | 1 | 1.5mm | 0.3mm min. |
| GRM31A5C3A560JW01D | 1000Vdc | C0G (EIA) | 56pF±5% | 3.2 | 1.6 | 1 | 1.5mm | 0.3mm min. |
| GRM31A5C3A680JW01D | 1000Vdc | C0G (EIA) | 68pF±5% | 3.2 | 1.6 | 1 | 1.5mm | 0.3mm min. |
| GRM31A5C3A820JW01D | 1000Vdc | C0G (EIA) | 82pF±5% | 3.2 | 1.6 | 1 | 1.5mm | 0.3mm min. |
| GRM31A5C3A101JW01D | 1000Vdc | C0G (EIA) | 100pF±5% | 3.2 | 1.6 | 1 | 1.5mm | 0.3mm min. |
| GRM31A5C3A121JW01D | 1000Vdc | C0G (EIA) | 120pF±5% | 3.2 | 1.6 | 1 | 1.5mm | 0.3mm min. |
| GRM31A5C3A151JW01D | 1000Vdc | C0G (EIA) | 150pF±5% | 3.2 | 1.6 | 1 | 1.5mm | 0.3mm min. |
| GRM31A5C3A181JW01D | 1000Vdc | C0G (EIA) | 180pF±5% | 3.2 | 1.6 | 1 | 1.5mm | 0.3mm min. |
| GRM31A5C3A221JW01D | 1000Vdc | C0G (EIA) | 220pF±5% | 3.2 | 1.6 | 1 | 1.5mm | 0.3mm min. |

U2J Characteristics

| Part Number | Rated Voltage | TC Code (Standard) | Capacitance | Length L (mm) | Width W (mm) | Thickness T max. (mm) | Electrode g min. | Electrode e |
|--------------------|---------------|--------------------|-------------|---------------|--------------|-----------------------|------------------|-------------|
| GRM21A7U2E101JW31D | 250Vdc | U2J (EIA) | 100pF±5% | 2 | 1.25 | 1 | 0.7mm | 0.3mm min. |
| GRM21A7U2E121JW31D | 250Vdc | U2J (EIA) | 120pF±5% | 2 | 1.25 | 1 | 0.7mm | 0.3mm min. |
| GRM21A7U2E151JW31D | 250Vdc | U2J (EIA) | 150pF±5% | 2 | 1.25 | 1 | 0.7mm | 0.3mm min. |
| GRM21A7U2E181JW31D | 250Vdc | U2J (EIA) | 180pF±5% | 2 | 1.25 | 1 | 0.7mm | 0.3mm min. |
| GRM21A7U2E221JW31D | 250Vdc | U2J (EIA) | 220pF±5% | 2 | 1.25 | 1 | 0.7mm | 0.3mm min. |
| GRM21A7U2E271JW31D | 250Vdc | U2J (EIA) | 270pF±5% | 2 | 1.25 | 1 | 0.7mm | 0.3mm min. |
| GRM21A7U2E331JW31D | 250Vdc | U2J (EIA) | 330pF±5% | 2 | 1.25 | 1 | 0.7mm | 0.3mm min. |
| GRM21A7U2E391JW31D | 250Vdc | U2J (EIA) | 390pF±5% | 2 | 1.25 | 1 | 0.7mm | 0.3mm min. |
| GRM21A7U2E471JW31D | 250Vdc | U2J (EIA) | 470pF±5% | 2 | 1.25 | 1 | 0.7mm | 0.3mm min. |
| GRM21A7U2E561JW31D | 250Vdc | U2J (EIA) | 560pF±5% | 2 | 1.25 | 1 | 0.7mm | 0.3mm min. |
| GRM21A7U2E681JW31D | 250Vdc | U2J (EIA) | 680pF±5% | 2 | 1.25 | 1 | 0.7mm | 0.3mm min. |
| GRM21A7U2E821JW31D | 250Vdc | U2J (EIA) | 820pF±5% | 2 | 1.25 | 1 | 0.7mm | 0.3mm min. |
| GRM21A7U2E102JW31D | 250Vdc | U2J (EIA) | 1000pF±5% | 2 | 1.25 | 1 | 0.7mm | 0.3mm min. |

Continued on the following page. ↗

Continued from the preceding page.

| Part Number | Rated Voltage | TC Code (Standard) | Capacitance | Length L (mm) | Width W (mm) | Thickness T max. (mm) | Electrode g min. | Electrode e |
|--------------------|---------------|--------------------|-------------|---------------|--------------|-----------------------|------------------|-------------|
| GRM21A7U2E122JW31D | 250Vdc | U2J (EIA) | 1200pF±5% | 2 | 1.25 | 1 | 0.7mm | 0.3mm min. |
| GRM21A7U2E152JW31D | 250Vdc | U2J (EIA) | 1500pF±5% | 2 | 1.25 | 1 | 0.7mm | 0.3mm min. |
| GRM21A7U2E182JW31D | 250Vdc | U2J (EIA) | 1800pF±5% | 2 | 1.25 | 1 | 0.7mm | 0.3mm min. |
| GRM21A7U2E222JW31D | 250Vdc | U2J (EIA) | 2200pF±5% | 2 | 1.25 | 1 | 0.7mm | 0.3mm min. |
| GRM21B7U2E272JW32L | 250Vdc | U2J (EIA) | 2700pF±5% | 2 | 1.25 | 1.45 | 0.7mm | 0.3mm min. |
| GRM31A7U2E272JW31D | 250Vdc | U2J (EIA) | 2700pF±5% | 3.2 | 1.6 | 1 | 1.5mm | 0.3mm min. |
| GRM21B7U2E332JW32L | 250Vdc | U2J (EIA) | 3300pF±5% | 2 | 1.25 | 1.45 | 0.7mm | 0.3mm min. |
| GRM31A7U2E332JW31D | 250Vdc | U2J (EIA) | 3300pF±5% | 3.2 | 1.6 | 1 | 1.5mm | 0.3mm min. |
| GRM21B7U2E392JW32L | 250Vdc | U2J (EIA) | 3900pF±5% | 2 | 1.25 | 1.45 | 0.7mm | 0.3mm min. |
| GRM31A7U2E392JW31D | 250Vdc | U2J (EIA) | 3900pF±5% | 3.2 | 1.6 | 1 | 1.5mm | 0.3mm min. |
| GRM21B7U2E472JW32L | 250Vdc | U2J (EIA) | 4700pF±5% | 2 | 1.25 | 1.45 | 0.7mm | 0.3mm min. |
| GRM31A7U2E472JW31D | 250Vdc | U2J (EIA) | 4700pF±5% | 3.2 | 1.6 | 1 | 1.5mm | 0.3mm min. |
| GRM21B7U2E562JW32L | 250Vdc | U2J (EIA) | 5600pF±5% | 2 | 1.25 | 1.45 | 0.7mm | 0.3mm min. |
| GRM31A7U2E562JW31D | 250Vdc | U2J (EIA) | 5600pF±5% | 3.2 | 1.6 | 1 | 1.5mm | 0.3mm min. |
| GRM31B7U2E682JW31L | 250Vdc | U2J (EIA) | 6800pF±5% | 3.2 | 1.6 | 1.25 | 1.5mm | 0.3mm min. |
| GRM31B7U2E822JW31L | 250Vdc | U2J (EIA) | 8200pF±5% | 3.2 | 1.6 | 1.25 | 1.5mm | 0.3mm min. |
| GRM31B7U2E103JW31L | 250Vdc | U2J (EIA) | 10000pF±5% | 3.2 | 1.6 | 1.25 | 1.5mm | 0.3mm min. |
| GRM31A7U2J100JW31D | 630Vdc | U2J (EIA) | 10pF±5% | 3.2 | 1.6 | 1 | 1.5mm | 0.3mm min. |
| GRM31A7U2J120JW31D | 630Vdc | U2J (EIA) | 12pF±5% | 3.2 | 1.6 | 1 | 1.5mm | 0.3mm min. |
| GRM31A7U2J150JW31D | 630Vdc | U2J (EIA) | 15pF±5% | 3.2 | 1.6 | 1 | 1.5mm | 0.3mm min. |
| GRM31A7U2J180JW31D | 630Vdc | U2J (EIA) | 18pF±5% | 3.2 | 1.6 | 1 | 1.5mm | 0.3mm min. |
| GRM31A7U2J220JW31D | 630Vdc | U2J (EIA) | 22pF±5% | 3.2 | 1.6 | 1 | 1.5mm | 0.3mm min. |
| GRM31A7U2J270JW31D | 630Vdc | U2J (EIA) | 27pF±5% | 3.2 | 1.6 | 1 | 1.5mm | 0.3mm min. |
| GRM31A7U2J330JW31D | 630Vdc | U2J (EIA) | 33pF±5% | 3.2 | 1.6 | 1 | 1.5mm | 0.3mm min. |
| GRM31A7U2J390JW31D | 630Vdc | U2J (EIA) | 39pF±5% | 3.2 | 1.6 | 1 | 1.5mm | 0.3mm min. |
| GRM31A7U2J470JW31D | 630Vdc | U2J (EIA) | 47pF±5% | 3.2 | 1.6 | 1 | 1.5mm | 0.3mm min. |
| GRM31A7U2J560JW31D | 630Vdc | U2J (EIA) | 56pF±5% | 3.2 | 1.6 | 1 | 1.5mm | 0.3mm min. |
| GRM31A7U2J680JW31D | 630Vdc | U2J (EIA) | 68pF±5% | 3.2 | 1.6 | 1 | 1.5mm | 0.3mm min. |
| GRM31A7U2J820JW31D | 630Vdc | U2J (EIA) | 82pF±5% | 3.2 | 1.6 | 1 | 1.5mm | 0.3mm min. |
| GRM31A7U2J101JW31D | 630Vdc | U2J (EIA) | 100pF±5% | 3.2 | 1.6 | 1 | 1.5mm | 0.3mm min. |
| GRM31A7U2J121JW31D | 630Vdc | U2J (EIA) | 120pF±5% | 3.2 | 1.6 | 1 | 1.5mm | 0.3mm min. |
| GRM31A7U2J151JW31D | 630Vdc | U2J (EIA) | 150pF±5% | 3.2 | 1.6 | 1 | 1.5mm | 0.3mm min. |
| GRM31A7U2J181JW31D | 630Vdc | U2J (EIA) | 180pF±5% | 3.2 | 1.6 | 1 | 1.5mm | 0.3mm min. |
| GRM31A7U2J221JW31D | 630Vdc | U2J (EIA) | 220pF±5% | 3.2 | 1.6 | 1 | 1.5mm | 0.3mm min. |
| GRM31A7U2J271JW31D | 630Vdc | U2J (EIA) | 270pF±5% | 3.2 | 1.6 | 1 | 1.5mm | 0.3mm min. |
| GRM31A7U2J331JW31D | 630Vdc | U2J (EIA) | 330pF±5% | 3.2 | 1.6 | 1 | 1.5mm | 0.3mm min. |
| GRM31A7U2J391JW31D | 630Vdc | U2J (EIA) | 390pF±5% | 3.2 | 1.6 | 1 | 1.5mm | 0.3mm min. |
| GRM31A7U2J471JW31D | 630Vdc | U2J (EIA) | 470pF±5% | 3.2 | 1.6 | 1 | 1.5mm | 0.3mm min. |
| GRM31A7U2J561JW31D | 630Vdc | U2J (EIA) | 560pF±5% | 3.2 | 1.6 | 1 | 1.5mm | 0.3mm min. |
| GRM31A7U2J681JW31D | 630Vdc | U2J (EIA) | 680pF±5% | 3.2 | 1.6 | 1 | 1.5mm | 0.3mm min. |
| GRM31A7U2J821JW31D | 630Vdc | U2J (EIA) | 820pF±5% | 3.2 | 1.6 | 1 | 1.5mm | 0.3mm min. |
| GRM31A7U2J102JW31D | 630Vdc | U2J (EIA) | 1000pF±5% | 3.2 | 1.6 | 1 | 1.5mm | 0.3mm min. |
| GRM31A7U2J122JW31D | 630Vdc | U2J (EIA) | 1200pF±5% | 3.2 | 1.6 | 1 | 1.5mm | 0.3mm min. |
| GRM32A7U2J122JW31D | 630Vdc | U2J (EIA) | 1200pF±5% | 3.2 | 2.5 | 1 | 1.5mm | 0.3mm min. |
| GRM31A7U2J152JW31D | 630Vdc | U2J (EIA) | 1500pF±5% | 3.2 | 1.6 | 1 | 1.5mm | 0.3mm min. |
| GRM32A7U2J152JW31D | 630Vdc | U2J (EIA) | 1500pF±5% | 3.2 | 2.5 | 1 | 1.5mm | 0.3mm min. |
| GRM31A7U2J182JW31D | 630Vdc | U2J (EIA) | 1800pF±5% | 3.2 | 1.6 | 1 | 1.5mm | 0.3mm min. |
| GRM32A7U2J182JW31D | 630Vdc | U2J (EIA) | 1800pF±5% | 3.2 | 2.5 | 1 | 1.5mm | 0.3mm min. |
| GRM31A7U2J222JW31D | 630Vdc | U2J (EIA) | 2200pF±5% | 3.2 | 1.6 | 1 | 1.5mm | 0.3mm min. |
| GRM32A7U2J222JW31D | 630Vdc | U2J (EIA) | 2200pF±5% | 3.2 | 2.5 | 1 | 1.5mm | 0.3mm min. |
| GRM31B7U2J272JW31L | 630Vdc | U2J (EIA) | 2700pF±5% | 3.2 | 1.6 | 1.25 | 1.5mm | 0.3mm min. |
| GRM31B7U2J332JW31L | 630Vdc | U2J (EIA) | 3300pF±5% | 3.2 | 1.6 | 1.25 | 1.5mm | 0.3mm min. |
| GRM31C7U2J392JW32L | 630Vdc | U2J (EIA) | 3900pF±5% | 3.2 | 1.6 | 1.8 | 1.5mm | 0.3mm min. |
| GRM31C7U2J472JW32L | 630Vdc | U2J (EIA) | 4700pF±5% | 3.2 | 1.6 | 1.8 | 1.5mm | 0.3mm min. |
| GRM32B7U2J562JW31L | 630Vdc | U2J (EIA) | 5600pF±5% | 3.2 | 2.5 | 1.25 | 1.5mm | 0.3mm min. |
| GRM32Q7U2J682JW31L | 630Vdc | U2J (EIA) | 6800pF±5% | 3.2 | 2.5 | 1.5 | 1.5mm | 0.3mm min. |
| GRM32D7U2J822JW31L | 630Vdc | U2J (EIA) | 8200pF±5% | 3.2 | 2.5 | 2 | 1.5mm | 0.3mm min. |

Continued on the following page. ↗

For General Purpose GRM/GRU/GR3 Series
 Only for Applications
 AC250V Type GA2 Series
 Safety Standard Certified GA3 Series
 Product Information

Continued from the preceding page.

| Part Number | Rated Voltage | TC Code (Standard) | Capacitance | Length L (mm) | Width W (mm) | Thickness T max. (mm) | Electrode g min. | Electrode e |
|--------------------|---------------|--------------------|-------------|---------------|--------------|-----------------------|------------------|-------------|
| GRM32D7U2J103JW31L | 630Vdc | U2J (EIA) | 1000pF±5% | 3.2 | 2.5 | 2 | 1.5mm | 0.3mm min. |
| GRM43Q7U2J123JW31L | 630Vdc | U2J (EIA) | 1200pF±5% | 4.5 | 3.2 | 1.5 | 2.2mm | 0.3mm min. |
| GRM43D7U2J153JW31L | 630Vdc | U2J (EIA) | 1500pF±5% | 4.5 | 3.2 | 2 | 2.2mm | 0.3mm min. |
| GRM43D7U2J183JW31L | 630Vdc | U2J (EIA) | 1800pF±5% | 4.5 | 3.2 | 2 | 2.2mm | 0.3mm min. |
| GRM43D7U2J223JW31L | 630Vdc | U2J (EIA) | 2200pF±5% | 4.5 | 3.2 | 2 | 2.2mm | 0.3mm min. |
| GRM55Q7U2J273JW31L | 630Vdc | U2J (EIA) | 2700pF±5% | 5.7 | 5.0 | 1.5 | 3.2mm | 0.3mm min. |
| GRM55D7U2J333JW31L | 630Vdc | U2J (EIA) | 3300pF±5% | 5.7 | 5.0 | 2 | 3.2mm | 0.3mm min. |
| GRM55D7U2J393JW31L | 630Vdc | U2J (EIA) | 3900pF±5% | 5.7 | 5.0 | 2 | 3.2mm | 0.3mm min. |
| GRM55D7U2J473JW31L | 630Vdc | U2J (EIA) | 4700pF±5% | 5.7 | 5.0 | 2 | 3.2mm | 0.3mm min. |
| GRM31A7U3A100JW31D | 1000Vdc | U2J (EIA) | 10pF±5% | 3.2 | 1.6 | 1 | 1.5mm | 0.3mm min. |
| GRM31A7U3A120JW31D | 1000Vdc | U2J (EIA) | 12pF±5% | 3.2 | 1.6 | 1 | 1.5mm | 0.3mm min. |
| GRM31A7U3A150JW31D | 1000Vdc | U2J (EIA) | 15pF±5% | 3.2 | 1.6 | 1 | 1.5mm | 0.3mm min. |
| GRM31A7U3A180JW31D | 1000Vdc | U2J (EIA) | 18pF±5% | 3.2 | 1.6 | 1 | 1.5mm | 0.3mm min. |
| GRM31A7U3A220JW31D | 1000Vdc | U2J (EIA) | 22pF±5% | 3.2 | 1.6 | 1 | 1.5mm | 0.3mm min. |
| GRM31A7U3A270JW31D | 1000Vdc | U2J (EIA) | 27pF±5% | 3.2 | 1.6 | 1 | 1.5mm | 0.3mm min. |
| GRM31A7U3A330JW31D | 1000Vdc | U2J (EIA) | 33pF±5% | 3.2 | 1.6 | 1 | 1.5mm | 0.3mm min. |
| GRM31A7U3A390JW31D | 1000Vdc | U2J (EIA) | 39pF±5% | 3.2 | 1.6 | 1 | 1.5mm | 0.3mm min. |
| GRM31A7U3A470JW31D | 1000Vdc | U2J (EIA) | 47pF±5% | 3.2 | 1.6 | 1 | 1.5mm | 0.3mm min. |
| GRM31A7U3A560JW31D | 1000Vdc | U2J (EIA) | 56pF±5% | 3.2 | 1.6 | 1 | 1.5mm | 0.3mm min. |
| GRM31A7U3A680JW31D | 1000Vdc | U2J (EIA) | 68pF±5% | 3.2 | 1.6 | 1 | 1.5mm | 0.3mm min. |
| GRM31A7U3A820JW31D | 1000Vdc | U2J (EIA) | 82pF±5% | 3.2 | 1.6 | 1 | 1.5mm | 0.3mm min. |
| GRM31A7U3A101JW31D | 1000Vdc | U2J (EIA) | 100pF±5% | 3.2 | 1.6 | 1 | 1.5mm | 0.3mm min. |
| GRM31A7U3A121JW31D | 1000Vdc | U2J (EIA) | 120pF±5% | 3.2 | 1.6 | 1 | 1.5mm | 0.3mm min. |
| GRM31A7U3A151JW31D | 1000Vdc | U2J (EIA) | 150pF±5% | 3.2 | 1.6 | 1 | 1.5mm | 0.3mm min. |
| GRM31A7U3A181JW31D | 1000Vdc | U2J (EIA) | 180pF±5% | 3.2 | 1.6 | 1 | 1.5mm | 0.3mm min. |
| GRM31A7U3A221JW31D | 1000Vdc | U2J (EIA) | 220pF±5% | 3.2 | 1.6 | 1 | 1.5mm | 0.3mm min. |
| GRM31A7U3A271JW31D | 1000Vdc | U2J (EIA) | 270pF±5% | 3.2 | 1.6 | 1 | 1.5mm | 0.3mm min. |
| GRM31A7U3A331JW31D | 1000Vdc | U2J (EIA) | 330pF±5% | 3.2 | 1.6 | 1 | 1.5mm | 0.3mm min. |
| GRM31B7U3A391JW31L | 1000Vdc | U2J (EIA) | 390pF±5% | 3.2 | 1.6 | 1.25 | 1.5mm | 0.3mm min. |
| GRM31B7U3A471JW31L | 1000Vdc | U2J (EIA) | 470pF±5% | 3.2 | 1.6 | 1.25 | 1.5mm | 0.3mm min. |
| GRM31B7U3A561JW31L | 1000Vdc | U2J (EIA) | 560pF±5% | 3.2 | 1.6 | 1.25 | 1.5mm | 0.3mm min. |
| GRM31B7U3A681JW31L | 1000Vdc | U2J (EIA) | 680pF±5% | 3.2 | 1.6 | 1.25 | 1.5mm | 0.3mm min. |
| GRM31C7U3A821JW32L | 1000Vdc | U2J (EIA) | 820pF±5% | 3.2 | 1.6 | 1.8 | 1.5mm | 0.3mm min. |
| GRM31C7U3A102JW32L | 1000Vdc | U2J (EIA) | 1000pF±5% | 3.2 | 1.6 | 1.8 | 1.5mm | 0.3mm min. |
| GRM32B7U3A122JW31L | 1000Vdc | U2J (EIA) | 1200pF±5% | 3.2 | 2.5 | 1.25 | 1.5mm | 0.3mm min. |
| GRM32Q7U3A152JW31L | 1000Vdc | U2J (EIA) | 1500pF±5% | 3.2 | 2.5 | 1.5 | 1.5mm | 0.3mm min. |
| GRM32D7U3A182JW31L | 1000Vdc | U2J (EIA) | 1800pF±5% | 3.2 | 2.5 | 2 | 1.5mm | 0.3mm min. |
| GRM32D7U3A222JW31L | 1000Vdc | U2J (EIA) | 2200pF±5% | 3.2 | 2.5 | 2 | 1.5mm | 0.3mm min. |
| GRM43Q7U3A272JW31L | 1000Vdc | U2J (EIA) | 2700pF±5% | 4.5 | 3.2 | 1.5 | 2.2mm | 0.3mm min. |
| GRM43Q7U3A332JW31L | 1000Vdc | U2J (EIA) | 3300pF±5% | 4.5 | 3.2 | 1.5 | 2.2mm | 0.3mm min. |
| GRM43D7U3A392JW31L | 1000Vdc | U2J (EIA) | 3900pF±5% | 4.5 | 3.2 | 2 | 2.2mm | 0.3mm min. |
| GRM43D7U3A472JW31L | 1000Vdc | U2J (EIA) | 4700pF±5% | 4.5 | 3.2 | 2 | 2.2mm | 0.3mm min. |
| GRM55Q7U3A562JW31L | 1000Vdc | U2J (EIA) | 5600pF±5% | 5.7 | 5.0 | 1.5 | 3.2mm | 0.3mm min. |
| GRM55Q7U3A682JW31L | 1000Vdc | U2J (EIA) | 6800pF±5% | 5.7 | 5.0 | 1.5 | 3.2mm | 0.3mm min. |
| GRM55D7U3A822JW31L | 1000Vdc | U2J (EIA) | 8200pF±5% | 5.7 | 5.0 | 2 | 3.2mm | 0.3mm min. |
| GRM55D7U3A103JW31L | 1000Vdc | U2J (EIA) | 10000pF±5% | 5.7 | 5.0 | 2 | 3.2mm | 0.3mm min. |
| GRM31A7U3D100JW31D | 2000Vdc | U2J (EIA) | 10pF±5% | 3.2 | 1.6 | 1 | 1.8mm | 0.3mm min. |
| GRM31A7U3D120JW31D | 2000Vdc | U2J (EIA) | 12pF±5% | 3.2 | 1.6 | 1 | 1.8mm | 0.3mm min. |
| GRM31A7U3D150JW31D | 2000Vdc | U2J (EIA) | 15pF±5% | 3.2 | 1.6 | 1 | 1.8mm | 0.3mm min. |
| GRM31A7U3D180JW31D | 2000Vdc | U2J (EIA) | 18pF±5% | 3.2 | 1.6 | 1 | 1.8mm | 0.3mm min. |
| GRM31A7U3D220JW31D | 2000Vdc | U2J (EIA) | 22pF±5% | 3.2 | 1.6 | 1 | 1.8mm | 0.3mm min. |
| GRM31A7U3D270JW31D | 2000Vdc | U2J (EIA) | 27pF±5% | 3.2 | 1.6 | 1 | 1.8mm | 0.3mm min. |
| GRM31A7U3D330JW31D | 2000Vdc | U2J (EIA) | 33pF±5% | 3.2 | 1.6 | 1 | 1.8mm | 0.3mm min. |
| GRM31A7U3D390JW31D | 2000Vdc | U2J (EIA) | 39pF±5% | 3.2 | 1.6 | 1 | 1.8mm | 0.3mm min. |
| GRM31A7U3D470JW31D | 2000Vdc | U2J (EIA) | 47pF±5% | 3.2 | 1.6 | 1 | 1.8mm | 0.3mm min. |
| GRM31A7U3D560JW31D | 2000Vdc | U2J (EIA) | 56pF±5% | 3.2 | 1.6 | 1 | 1.8mm | 0.3mm min. |
| GRM31A7U3D680JW31D | 2000Vdc | U2J (EIA) | 68pF±5% | 3.2 | 1.6 | 1 | 1.8mm | 0.3mm min. |

For General Purpose
GRM/GRJ/GR3 Series

Only for Applications

AC250V Type
GA2 Series

Safety Standard
Certified GA3 Series

Product Information

Continued on the following page. ↗

Continued from the preceding page.

| Part Number | Rated Voltage | TC Code (Standard) | Capacitance | Length L (mm) | Width W (mm) | Thickness T max. (mm) | Electrode g min. | Electrode e |
|--------------------|---------------|--------------------|-------------|---------------|--------------|-----------------------|------------------|-------------|
| GRM32A7U3D820JW31D | 2000Vdc | U2J (EIA) | 82pF±5% | 3.2 | 2.5 | 1 | 1.8mm | 0.3mm min. |
| GRM32A7U3D101JW31D | 2000Vdc | U2J (EIA) | 100pF±5% | 3.2 | 2.5 | 1 | 1.8mm | 0.3mm min. |
| GRM32A7U3D121JW31D | 2000Vdc | U2J (EIA) | 120pF±5% | 3.2 | 2.5 | 1 | 1.8mm | 0.3mm min. |
| GRM32A7U3D151JW31D | 2000Vdc | U2J (EIA) | 150pF±5% | 3.2 | 2.5 | 1 | 1.8mm | 0.3mm min. |
| GRM32B7U3D181JW31L | 2000Vdc | U2J (EIA) | 180pF±5% | 3.2 | 2.5 | 1.25 | 1.8mm | 0.3mm min. |
| GRM32B7U3D221JW31L | 2000Vdc | U2J (EIA) | 220pF±5% | 3.2 | 2.5 | 1.25 | 1.8mm | 0.3mm min. |
| GRM42A7U3F270JW31L | 3150Vdc | U2J (EIA) | 27pF±5% | 4.5 | 2.0 | 1 | 2.9mm | 0.3mm min. |
| GRM42A7U3F330JW31L | 3150Vdc | U2J (EIA) | 33pF±5% | 4.5 | 2.0 | 1 | 2.9mm | 0.3mm min. |
| GRM42A7U3F390JW31L | 3150Vdc | U2J (EIA) | 39pF±5% | 4.5 | 2.0 | 1 | 2.9mm | 0.3mm min. |
| GRM42A7U3F470JW31L | 3150Vdc | U2J (EIA) | 47pF±5% | 4.5 | 2.0 | 1 | 2.9mm | 0.3mm min. |
| GRM42A7U3F560JW31L | 3150Vdc | U2J (EIA) | 56pF±5% | 4.5 | 2.0 | 1 | 2.9mm | 0.3mm min. |
| GRM42A7U3F680JW31L | 3150Vdc | U2J (EIA) | 68pF±5% | 4.5 | 2.0 | 1 | 2.9mm | 0.3mm min. |
| GRM42A7U3F820JW31L | 3150Vdc | U2J (EIA) | 82pF±5% | 4.5 | 2.0 | 1 | 2.9mm | 0.3mm min. |
| GRM42A7U3F101JW31L | 3150Vdc | U2J (EIA) | 100pF±5% | 4.5 | 2.0 | 1 | 2.9mm | 0.3mm min. |

For General Purpose GRM/GRU/GR3 Series

Only for Applications

AC250V Type GA2 Series

Safety Standard Certified GA3 Series

Product Information

GRM Series Specifications and Test Methods

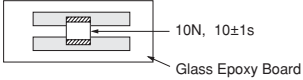
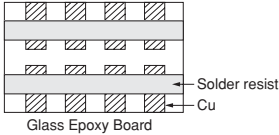
| No. | Item | Specifications | Test Method | | | | | | | | | |
|------------------------|---|--|---|---------------|------------------|--------|---------------------------|--------|---------------------------|------------------------|---------------------------|---|
| 1 | Operating Temperature Range | -55 to +125°C | - | | | | | | | | | |
| 2 | Appearance | No defects or abnormalities | Visual inspection | | | | | | | | | |
| 3 | Dimensions | Within the specified dimension | Using calipers and micrometers | | | | | | | | | |
| 4 | Dielectric Strength | No defects or abnormalities | <p>No failure should be observed when voltage in the Table is applied between the terminations for 1 to 5 sec., provided the charge/discharge current is less than 50mA.</p> <table border="1" style="width: 100%; border-collapse: collapse; margin-top: 10px;"> <thead> <tr style="background-color: #f2f2f2;"> <th>Rated Voltage</th> <th>Test Voltage</th> </tr> </thead> <tbody> <tr> <td>DC250V</td> <td>200% of the rated voltage</td> </tr> <tr> <td>DC630V</td> <td>150% of the rated voltage</td> </tr> <tr> <td>DC1kV, DC2kV, DC3.15kV</td> <td>130% of the rated voltage</td> </tr> </tbody> </table> | Rated Voltage | Test Voltage | DC250V | 200% of the rated voltage | DC630V | 150% of the rated voltage | DC1kV, DC2kV, DC3.15kV | 130% of the rated voltage | |
| Rated Voltage | Test Voltage | | | | | | | | | | | |
| DC250V | 200% of the rated voltage | | | | | | | | | | | |
| DC630V | 150% of the rated voltage | | | | | | | | | | | |
| DC1kV, DC2kV, DC3.15kV | 130% of the rated voltage | | | | | | | | | | | |
| 5 | Insulation Resistance (I.R.) | More than 10,000MΩ | The insulation resistance should be measured with DC500±50V (DC250±25V in case of rated voltage: DC250V) and within 60±5 sec. of charging. | | | | | | | | | |
| 6 | Capacitance | Within the specified tolerance | The capacitance/Q should be measured at the frequency and voltage shown as follows. | | | | | | | | | |
| 7 | Q | 1,000 min. | | | | | | | | | | |
| 8 | Capacitance Temperature Characteristics | Temp. Coefficient C0G char. : 0±30ppm/°C (Temp. Range : +25 to +125°C) 0+30, -72ppm/°C (Temp. Range : -55 to +25°C) U2J char. : -750±120ppm/°C (Temp. Range : +25 to +125°C) -750+120, -347ppm/°C (Temp. Range : -55 to +25°C) | The capacitance measurement should be made at each step specified in the Table. | | | | | | | | | |
| | | | <table border="1" style="width: 100%; border-collapse: collapse; margin-top: 10px;"> <thead> <tr style="background-color: #f2f2f2;"> <th>Step</th> <th>Temperature (°C)</th> </tr> </thead> <tbody> <tr> <td>1</td> <td>25±2</td> </tr> <tr> <td>2</td> <td>Min. Operating Temp.±3</td> </tr> <tr> <td>3</td> <td>25±2</td> </tr> <tr> <td>4</td> <td>Max. Operating Temp.±2</td> </tr> <tr> <td>5</td> <td>25±2</td> </tr> </tbody> </table> | Step | Temperature (°C) | 1 | 25±2 | 2 | Min. Operating Temp.±3 | 3 | 25±2 | 4 |
| Step | Temperature (°C) | | | | | | | | | | | |
| 1 | 25±2 | | | | | | | | | | | |
| 2 | Min. Operating Temp.±3 | | | | | | | | | | | |
| 3 | 25±2 | | | | | | | | | | | |
| 4 | Max. Operating Temp.±2 | | | | | | | | | | | |
| 5 | 25±2 | | | | | | | | | | | |
| 9 | Adhesive Strength of Termination | No removal of the terminations or other defect should occur. | <p>Solder the capacitor to the testing jig (glass epoxy board) shown in Fig. 1.</p> <p>Then apply 10N force in the direction of the arrow.</p> <p>The soldering should be done using the reflow method and should be conducted with care so that the soldering is uniform and free of defects such as heat shock.</p> <div style="text-align: center; margin-top: 10px;">  <p>10N, 10±1s Glass Epoxy Board</p> </div> <p style="text-align: center;">Fig. 1</p> | | | | | | | | | |
| 10 | Vibration Resistance | Appearance | No defects or abnormalities | | | | | | | | | |
| | | Capacitance | Within the specified tolerance | | | | | | | | | |
| | | Q | 1,000 min. | | | | | | | | | |
| | | | <p>Solder the capacitor to the test jig (glass epoxy board).</p> <p>The capacitor should be subjected to a simple harmonic motion having a total amplitude of 1.5mm, the frequency being varied uniformly between the approximate limits of 10 and 55Hz. The frequency range, from 10 to 55Hz and return to 10Hz, should be traversed in approximately 1 min. This motion should be applied for a period of 2 hrs. in each of 3 mutually perpendicular directions (total of 6 hrs.).</p> <div style="text-align: center; margin-top: 10px;">  <p>Solder resist Cu Glass Epoxy Board</p> </div> | | | | | | | | | |

Continued on the following page.

For General Purpose GRM/GRJ/GR3 Series

Only for Applications

AC250V Type GA2 Series

Safety Standard Certified GA3 Series

Product Information

GRM Series Specifications and Test Methods

Continued from the preceding page.

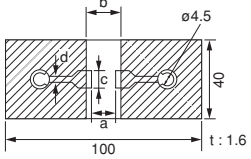
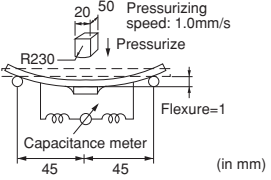
| No. | Item | Specifications | Test Method | | | | | | | | | | | | | | | | | | | | | | | | | | | | | | | |
|----------|------------------------------|--|---|---|----------------|--|--|--|---|---|---|---|----------|-----|-----|------|-----|---------|-----|-----|-----|---------|-----|-----|-----|---------|-----|-----|-----|---------|-----|-----|-----|---------|
| 11 | Deflection | No marking defects | Solder the capacitor to the testing jig (glass epoxy board) shown in Fig. 2. Then apply a force in the direction shown in Fig. 3. The soldering should be done using the reflow method and should be conducted with care so that the soldering is uniform and free of defects such as heat shock. | | | | | | | | | | | | | | | | | | | | | | | | | | | | | | | |
| | |  <p>Fig. 2</p> <table border="1"> <thead> <tr> <th rowspan="2">L×W (mm)</th> <th colspan="4">Dimension (mm)</th> </tr> <tr> <th>a</th> <th>b</th> <th>c</th> <th>d</th> </tr> </thead> <tbody> <tr> <td>2.0×1.25</td> <td>1.2</td> <td>4.0</td> <td>1.65</td> <td rowspan="6">1.0</td> </tr> <tr> <td>3.2×1.6</td> <td>2.2</td> <td>5.0</td> <td>2.0</td> </tr> <tr> <td>3.2×2.5</td> <td>2.2</td> <td>5.0</td> <td>2.9</td> </tr> <tr> <td>4.5×2.0</td> <td>3.5</td> <td>7.0</td> <td>2.4</td> </tr> <tr> <td>4.5×3.2</td> <td>3.5</td> <td>7.0</td> <td>3.7</td> </tr> <tr> <td>5.7×5.0</td> <td>4.5</td> <td>8.0</td> <td>5.6</td> </tr> </tbody> </table> | | L×W (mm) | Dimension (mm) | | | | a | b | c | d | 2.0×1.25 | 1.2 | 4.0 | 1.65 | 1.0 | 3.2×1.6 | 2.2 | 5.0 | 2.0 | 3.2×2.5 | 2.2 | 5.0 | 2.9 | 4.5×2.0 | 3.5 | 7.0 | 2.4 | 4.5×3.2 | 3.5 | 7.0 | 3.7 | 5.7×5.0 |
| L×W (mm) | Dimension (mm) | | | | | | | | | | | | | | | | | | | | | | | | | | | | | | | | | |
| | a | b | c | d | | | | | | | | | | | | | | | | | | | | | | | | | | | | | | |
| 2.0×1.25 | 1.2 | 4.0 | 1.65 | 1.0 | | | | | | | | | | | | | | | | | | | | | | | | | | | | | | |
| 3.2×1.6 | 2.2 | 5.0 | 2.0 | | | | | | | | | | | | | | | | | | | | | | | | | | | | | | | |
| 3.2×2.5 | 2.2 | 5.0 | 2.9 | | | | | | | | | | | | | | | | | | | | | | | | | | | | | | | |
| 4.5×2.0 | 3.5 | 7.0 | 2.4 | | | | | | | | | | | | | | | | | | | | | | | | | | | | | | | |
| 4.5×3.2 | 3.5 | 7.0 | 3.7 | | | | | | | | | | | | | | | | | | | | | | | | | | | | | | | |
| 5.7×5.0 | 4.5 | 8.0 | 5.6 | | | | | | | | | | | | | | | | | | | | | | | | | | | | | | | |
| | | |  <p>Fig. 3</p> | | | | | | | | | | | | | | | | | | | | | | | | | | | | | | | |
| 12 | Solderability of Termination | 75% of the terminations are to be soldered evenly and continuously. | Immerse the capacitor in a solution of ethanol (JIS-K-8101) and rosin (JIS-K-5902) (25% rosin in weight proportion). Immerse in solder solution for 2±0.5 sec. Immersing speed: 25±2.5mm/s Temp. of solder: 245±5°C Lead Free Solder (Sn-3.0Ag-0.5Cu) 235±5°C H60A or H63A Eutectic Solder | | | | | | | | | | | | | | | | | | | | | | | | | | | | | | | |
| 13 | Resistance to Soldering Heat | Appearance | No marking defects | Preheat the capacitor at 120 to 150°C* for 1 min. Immerse the capacitor in solder solution at 260±5°C for 10±1 sec. Let sit at room condition* for 24±2 hrs., then measure. •Immersing speed: 25±2.5mm/s *Preheating for more than 3.2×2.5mm | | | | | | | | | | | | | | | | | | | | | | | | | | | | | | |
| | | Capacitance Change | Within ±2.5% | | | | | | | | | | | | | | | | | | | | | | | | | | | | | | | |
| | | Q | 1,000 min. | | | | | | | | | | | | | | | | | | | | | | | | | | | | | | | |
| | | I.R. | More than 10,000MΩ | | | | | | | | | | | | | | | | | | | | | | | | | | | | | | | |
| | | Dielectric Strength | In accordance with item No.4 | | | | | | | | | | | | | | | | | | | | | | | | | | | | | | | |
| 14 | Temperature Cycle | Appearance | No marking defects | Fix the capacitor to the supporting jig (glass epoxy board) shown in Fig. 4. Perform the 5 cycles according to the 4 heat treatments listed in the following table. Let sit for 24±2 hrs. at room condition,* then measure. | | | | | | | | | | | | | | | | | | | | | | | | | | | | | | |
| | | Capacitance Change | Within ±2.5% | | | | | | | | | | | | | | | | | | | | | | | | | | | | | | | |
| | | Q | 500 min. | | | | | | | | | | | | | | | | | | | | | | | | | | | | | | | |
| | | I.R. | More than 10,000MΩ | | | | | | | | | | | | | | | | | | | | | | | | | | | | | | | |
| | | Dielectric Strength | In accordance with item No.4 | | | | | | | | | | | | | | | | | | | | | | | | | | | | | | | |
| 15 | Humidity (Steady State) | Appearance | No marking defects | Let the capacitor sit at 40±2°C and relative humidity of 90 to 95% for 500 ⁺²⁴ hrs. Remove and let sit for 24±2 hrs. at room condition,* then measure. | | | | | | | | | | | | | | | | | | | | | | | | | | | | | | |
| | | Capacitance Change | Within ±5.0% | | | | | | | | | | | | | | | | | | | | | | | | | | | | | | | |
| | | Q | 350 min. | | | | | | | | | | | | | | | | | | | | | | | | | | | | | | | |
| | | I.R. | More than 1,000MΩ | | | | | | | | | | | | | | | | | | | | | | | | | | | | | | | |
| | | Dielectric Strength | In accordance with item No.4 | | | | | | | | | | | | | | | | | | | | | | | | | | | | | | | |
| 16 | Life | Appearance | No marking defects | Apply voltage as in Table for 1,000 ⁺⁴⁸ hrs. at maximum operating temperature ±3°C. Remove and let sit for 24±2 hrs. at room condition,* then measure. | | | | | | | | | | | | | | | | | | | | | | | | | | | | | | |
| | | Capacitance Change | Within ±3.0% | | | | | | | | | | | | | | | | | | | | | | | | | | | | | | | |
| | | Q | 350 min. | | | | | | | | | | | | | | | | | | | | | | | | | | | | | | | |
| | | I.R. | More than 1,000MΩ | | | | | | | | | | | | | | | | | | | | | | | | | | | | | | | |
| | | Dielectric Strength | In accordance with item No.4 | | | | | | | | | | | | | | | | | | | | | | | | | | | | | | | |

| Step | Temperature | Time |
|------|--------------|--------|
| 1 | 100 to 120°C | 1 min. |
| 2 | 170 to 200°C | 1 min. |

| Step | Temperature (°C) | Time (min.) |
|------|------------------------|-------------|
| 1 | Min. Operating Temp.±3 | 30±3 |
| 2 | Room Temp. | 2 to 3 |
| 3 | Max. Operating Temp.±2 | 30±3 |
| 4 | Room Temp. | 2 to 3 |

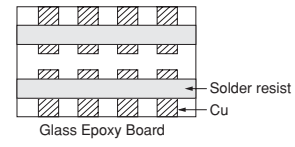

* "Room condition" Temperature: 15 to 35°C, Relative humidity: 45 to 75%, Atmospheric pressure: 86 to 106kPa

For General Purpose GRM/GRU/GR3 Series
 Only for Applications
 AC250V Type GA2 Series
 Safety Standard Certified GA3 Series
 Product Information

Chip Monolithic Ceramic Capacitors (Medium Voltage)

High Dielectric Constant Type GRM Series (250Vdc min.)

■ Features

1. A new monolithic structure for small, high capacitance capable of operating at high voltage levels.
2. Sn-plated external electrodes provide good solderability.
3. Use the GRM18/21/31 types with flow or reflow soldering, and other types with reflow soldering only.

■ Applications

1. Ideal for use on clamp-snubber circuits for switching power supplies.
2. Ideal for use as primary-secondary coupling for DC-DC converters.
3. Ideal for use on line filters and ringer detectors for telephones, facsimiles and modems.

Do not use these products in any Automotive Power train or Safety equipment including Battery chargers for Electric Vehicles and Plug-in Hybrids. Only Murata products clearly stipulated as "for Automotive use" can be used for automobile applications such as Power train and Safety equipment.

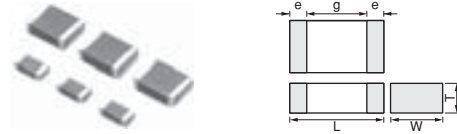

| Part Number | Dimensions (mm) | | | | | |
|-------------|-----------------|-----------|--------------|------------|--------|-----|
| | L | W | T | e | g min. | |
| GRM188 | 1.6 ±0.1 | 0.8 ±0.1 | 0.8 ±0.1 | 0.2 to 0.5 | 0.4 | |
| GRM21A | 2.0 ±0.2 | 1.25 ±0.2 | 1.0 +0,-0.3 | | | |
| GRM21B | | | 1.25 ±0.2 | | | |
| GRM31B | 3.2 ±0.2 | 1.6 ±0.2 | 1.25 +0,-0.3 | 0.3 min. | 1.2 | |
| GRM31C | | | 1.6 ±0.2 | | | |
| GRM32Q | 3.2 ±0.3 | 2.5 ±0.2 | 1.5 +0,-0.3 | | | |
| GRM32D | | | 2.0 +0,-0.3 | | | |
| GRM43Q | 4.5 ±0.4 | 3.2 ±0.3 | 1.5 +0,-0.3 | | | 2.2 |
| GRM43D | | | 2.0 +0,-0.3 | | | |
| GRM55D | 5.7 ±0.4 | 5.0 ±0.4 | 2.0 +0,-0.3 | 3.2 | | |

| Part Number | Rated Voltage | TC Code (Standard) | Capacitance | Length L (mm) | Width W (mm) | Thickness T max. (mm) | Electrode g min. | Electrode e |
|--------------------|---------------|--------------------|-------------|---------------|--------------|-----------------------|------------------|--------------|
| GRM188R72E221KW07D | 250Vdc | X7R (EIA) | 220pF±10% | 1.6 | 0.8 | 0.9 | 0.4mm | 0.2 to 0.5mm |
| GRM188R72E331KW07D | 250Vdc | X7R (EIA) | 330pF±10% | 1.6 | 0.8 | 0.9 | 0.4mm | 0.2 to 0.5mm |
| GRM188R72E471KW07D | 250Vdc | X7R (EIA) | 470pF±10% | 1.6 | 0.8 | 0.9 | 0.4mm | 0.2 to 0.5mm |
| GRM188R72E681KW07D | 250Vdc | X7R (EIA) | 680pF±10% | 1.6 | 0.8 | 0.9 | 0.4mm | 0.2 to 0.5mm |
| GRM188R72E102KW07D | 250Vdc | X7R (EIA) | 1000pF±10% | 1.6 | 0.8 | 0.9 | 0.4mm | 0.2 to 0.5mm |
| GRM21AR72E102KW01D | 250Vdc | X7R (EIA) | 1000pF±10% | 2 | 1.25 | 1 | 0.7mm | 0.3mm min. |
| GRM188R72E152KW07D | 250Vdc | X7R (EIA) | 1500pF±10% | 1.6 | 0.8 | 0.9 | 0.4mm | 0.2 to 0.5mm |
| GRM21AR72E152KW01D | 250Vdc | X7R (EIA) | 1500pF±10% | 2 | 1.25 | 1 | 0.7mm | 0.3mm min. |
| GRM188R72E222KW07D | 250Vdc | X7R (EIA) | 2200pF±10% | 1.6 | 0.8 | 0.9 | 0.4mm | 0.2 to 0.5mm |
| GRM21AR72E222KW01D | 250Vdc | X7R (EIA) | 2200pF±10% | 2 | 1.25 | 1 | 0.7mm | 0.3mm min. |
| GRM21AR72E332KW01D | 250Vdc | X7R (EIA) | 3300pF±10% | 2 | 1.25 | 1 | 0.7mm | 0.3mm min. |
| GRM21AR72E472KW01D | 250Vdc | X7R (EIA) | 4700pF±10% | 2 | 1.25 | 1 | 0.7mm | 0.3mm min. |
| GRM21AR72E682KW01D | 250Vdc | X7R (EIA) | 6800pF±10% | 2 | 1.25 | 1 | 0.7mm | 0.3mm min. |
| GRM21BR72E103KW03L | 250Vdc | X7R (EIA) | 10000pF±10% | 2 | 1.25 | 1.45 | 0.7mm | 0.3mm min. |
| GRM31BR72E153KW01L | 250Vdc | X7R (EIA) | 15000pF±10% | 3.2 | 1.6 | 1.25 | 1.2mm | 0.3mm min. |
| GRM31BR72E223KW01L | 250Vdc | X7R (EIA) | 22000pF±10% | 3.2 | 1.6 | 1.25 | 1.2mm | 0.3mm min. |
| GRM31CR72E333KW03L | 250Vdc | X7R (EIA) | 33000pF±10% | 3.2 | 1.6 | 1.8 | 1.2mm | 0.3mm min. |
| GRM31CR72E473KW03L | 250Vdc | X7R (EIA) | 47000pF±10% | 3.2 | 1.6 | 1.8 | 1.2mm | 0.3mm min. |
| GRM31BR72E683KW01L | 250Vdc | X7R (EIA) | 68000pF±10% | 3.2 | 1.6 | 1.25 | 1.2mm | 0.3mm min. |
| GRM32QR72E683KW01L | 250Vdc | X7R (EIA) | 68000pF±10% | 3.2 | 2.5 | 1.5 | 1.2mm | 0.3mm min. |
| GRM31CR72E104KW03L | 250Vdc | X7R (EIA) | 0.10µF±10% | 3.2 | 1.6 | 1.8 | 1.2mm | 0.3mm min. |
| GRM32DR72E104KW01L | 250Vdc | X7R (EIA) | 0.10µF±10% | 3.2 | 2.5 | 2 | 1.2mm | 0.3mm min. |
| GRM32QR72E154KW01L | 250Vdc | X7R (EIA) | 0.15µF±10% | 3.2 | 2.5 | 1.5 | 1.2mm | 0.3mm min. |
| GRM43QR72E154KW01L | 250Vdc | X7R (EIA) | 0.15µF±10% | 4.5 | 3.2 | 1.5 | 2.2mm | 0.3mm min. |
| GRM32DR72E224KW01L | 250Vdc | X7R (EIA) | 0.22µF±10% | 3.2 | 2.5 | 2 | 1.2mm | 0.3mm min. |

Continued on the following page.

Continued from the preceding page.

| Part Number | Rated Voltage | TC Code (Standard) | Capacitance | Length L (mm) | Width W (mm) | Thickness T max. (mm) | Electrode g min. | Electrode e |
|--------------------|---------------|--------------------|-------------|---------------|--------------|-----------------------|------------------|-------------|
| GRM43DR72E224KW01L | 250Vdc | X7R (EIA) | 0.22µF±10% | 4.5 | 3.2 | 2 | 2.2mm | 0.3mm min. |
| GRM43DR72E334KW01L | 250Vdc | X7R (EIA) | 0.33µF±10% | 4.5 | 3.2 | 2 | 2.2mm | 0.3mm min. |
| GRM55DR72E334KW01L | 250Vdc | X7R (EIA) | 0.33µF±10% | 5.7 | 5.0 | 2 | 3.2mm | 0.3mm min. |
| GRM43DR72E474KW01L | 250Vdc | X7R (EIA) | 0.47µF±10% | 4.5 | 3.2 | 2 | 2.2mm | 0.3mm min. |
| GRM55DR72E474KW01L | 250Vdc | X7R (EIA) | 0.47µF±10% | 5.7 | 5.0 | 2 | 3.2mm | 0.3mm min. |
| GRM55DR72E684KW01L | 250Vdc | X7R (EIA) | 0.68µF±10% | 5.7 | 5.0 | 2 | 3.2mm | 0.3mm min. |
| GRM55DR72E105KW01L | 250Vdc | X7R (EIA) | 1.0µF±10% | 5.7 | 5.0 | 2 | 3.2mm | 0.3mm min. |
| GRM31BR72J102KW01L | 630Vdc | X7R (EIA) | 1000pF±10% | 3.2 | 1.6 | 1.25 | 1.2mm | 0.3mm min. |
| GRM31BR72J152KW01L | 630Vdc | X7R (EIA) | 1500pF±10% | 3.2 | 1.6 | 1.25 | 1.2mm | 0.3mm min. |
| GRM31BR72J222KW01L | 630Vdc | X7R (EIA) | 2200pF±10% | 3.2 | 1.6 | 1.25 | 1.2mm | 0.3mm min. |
| GRM31BR72J332KW01L | 630Vdc | X7R (EIA) | 3300pF±10% | 3.2 | 1.6 | 1.25 | 1.2mm | 0.3mm min. |
| GRM31BR72J472KW01L | 630Vdc | X7R (EIA) | 4700pF±10% | 3.2 | 1.6 | 1.25 | 1.2mm | 0.3mm min. |
| GRM31BR72J682KW01L | 630Vdc | X7R (EIA) | 6800pF±10% | 3.2 | 1.6 | 1.25 | 1.2mm | 0.3mm min. |
| GRM31BR72J103KW01L | 630Vdc | X7R (EIA) | 10000pF±10% | 3.2 | 1.6 | 1.25 | 1.2mm | 0.3mm min. |
| GRM31CR72J153KW03L | 630Vdc | X7R (EIA) | 15000pF±10% | 3.2 | 1.6 | 1.8 | 1.2mm | 0.3mm min. |
| GRM32QR72J223KW01L | 630Vdc | X7R (EIA) | 22000pF±10% | 3.2 | 2.5 | 1.5 | 1.2mm | 0.3mm min. |
| GRM32DR72J333KW01L | 630Vdc | X7R (EIA) | 33000pF±10% | 3.2 | 2.5 | 2 | 1.2mm | 0.3mm min. |
| GRM32DR72J473KW01L | 630Vdc | X7R (EIA) | 47000pF±10% | 3.2 | 2.5 | 2 | 1.2mm | 0.3mm min. |
| GRM43QR72J683KW01L | 630Vdc | X7R (EIA) | 68000pF±10% | 4.5 | 3.2 | 1.5 | 2.2mm | 0.3mm min. |
| GRM43DR72J104KW01L | 630Vdc | X7R (EIA) | 0.10µF±10% | 4.5 | 3.2 | 2 | 2.2mm | 0.3mm min. |
| GRM55DR72J154KW01L | 630Vdc | X7R (EIA) | 0.15µF±10% | 5.7 | 5.0 | 2 | 3.2mm | 0.3mm min. |
| GRM55DR72J224KW01L | 630Vdc | X7R (EIA) | 0.22µF±10% | 5.7 | 5.0 | 2 | 3.2mm | 0.3mm min. |
| GRM31BR73A471KW01L | 1000Vdc | X7R (EIA) | 470pF±10% | 3.2 | 1.6 | 1.25 | 1.2mm | 0.3mm min. |
| GRM31BR73A681KW01L | 1000Vdc | X7R (EIA) | 680pF±10% | 3.2 | 1.6 | 1.25 | 1.2mm | 0.3mm min. |
| GRM31BR73A102KW01L | 1000Vdc | X7R (EIA) | 1000pF±10% | 3.2 | 1.6 | 1.25 | 1.2mm | 0.3mm min. |
| GRM31BR73A152KW01L | 1000Vdc | X7R (EIA) | 1500pF±10% | 3.2 | 1.6 | 1.25 | 1.2mm | 0.3mm min. |
| GRM31BR73A222KW01L | 1000Vdc | X7R (EIA) | 2200pF±10% | 3.2 | 1.6 | 1.25 | 1.2mm | 0.3mm min. |
| GRM31BR73A332KW01L | 1000Vdc | X7R (EIA) | 3300pF±10% | 3.2 | 1.6 | 1.25 | 1.2mm | 0.3mm min. |
| GRM31BR73A472KW01L | 1000Vdc | X7R (EIA) | 4700pF±10% | 3.2 | 1.6 | 1.25 | 1.2mm | 0.3mm min. |
| GRM32QR73A682KW01L | 1000Vdc | X7R (EIA) | 6800pF±10% | 3.2 | 2.5 | 1.5 | 1.2mm | 0.3mm min. |
| GRM32QR73A103KW01L | 1000Vdc | X7R (EIA) | 10000pF±10% | 3.2 | 2.5 | 1.5 | 1.2mm | 0.3mm min. |
| GRM32DR73A153KW01L | 1000Vdc | X7R (EIA) | 15000pF±10% | 3.2 | 2.5 | 2 | 1.2mm | 0.3mm min. |
| GRM32DR73A223KW01L | 1000Vdc | X7R (EIA) | 22000pF±10% | 3.2 | 2.5 | 2 | 1.2mm | 0.3mm min. |
| GRM43DR73A333KW01L | 1000Vdc | X7R (EIA) | 33000pF±10% | 4.5 | 3.2 | 2 | 2.2mm | 0.3mm min. |
| GRM43DR73A473KW01L | 1000Vdc | X7R (EIA) | 47000pF±10% | 4.5 | 3.2 | 2 | 2.2mm | 0.3mm min. |
| GRM55DR73A683KW01L | 1000Vdc | X7R (EIA) | 68000pF±10% | 5.7 | 5.0 | 2 | 3.2mm | 0.3mm min. |
| GRM55DR73A104KW01L | 1000Vdc | X7R (EIA) | 0.10µF±10% | 5.7 | 5.0 | 2 | 3.2mm | 0.3mm min. |

For General Purpose GRM/GRU/GFR3 Series

Only for Applications

AC250V Type GA2 Series

Safety Standard Certified GA3 Series

Product Information

GRM Series Specifications and Test Methods

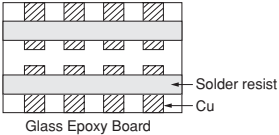
| No. | Item | Specifications | Test Method | | | | | | | | | |
|------|---|--|--|------|------------------|---|------|---|------------------------|---|------|---|
| 1 | Operating Temperature Range | -55 to +125°C | - | | | | | | | | | |
| 2 | Appearance | No defects or abnormalities | Visual inspection | | | | | | | | | |
| 3 | Dimensions | Within the specified dimensions | Using calipers and micrometers | | | | | | | | | |
| 4 | Dielectric Strength | No defects or abnormalities | No failure should be observed when 150% of the rated voltage (200% of the rated voltage in case of rated voltage: DC250V, 120% of the rated voltage in case of rated voltage: DC1kV) is applied between the terminations for 1 to 5 sec., provided the charge/discharge current is less than 50mA. | | | | | | | | | |
| 5 | Insulation Resistance (I.R.) | C ≥ 0.01μF: More than 100MΩ • μF C < 0.01μF: More than 10,000MΩ | The insulation resistance should be measured with DC500±50V (DC250±25V in case of rated voltage: DC250V) and within 60±5 sec. of charging. | | | | | | | | | |
| 6 | Capacitance | Within the specified tolerance | The capacitance/D.F. should be measured at a frequency of 1±0.2kHz and a voltage of AC1±0.2V(r.m.s.). | | | | | | | | | |
| 7 | Dissipation Factor (D.F.) | 0.025 max. | | | | | | | | | | |
| 8 | Capacitance Temperature Characteristics | Cap. Change Within ±15% (Temp. Range: -55 to +125°C) | The capacitance measurement should be made at each step specified in the Table. | | | | | | | | | |
| | | | <table border="1" style="width: 100%; border-collapse: collapse; text-align: center;"> <thead> <tr style="background-color: #f2f2f2;"> <th style="width: 20%;">Step</th> <th style="width: 80%;">Temperature (°C)</th> </tr> </thead> <tbody> <tr> <td>1</td> <td>25±2</td> </tr> <tr> <td>2</td> <td>Min. Operating Temp.±3</td> </tr> <tr> <td>3</td> <td>25±2</td> </tr> <tr> <td>4</td> <td>Max. Operating Temp.±2</td> </tr> <tr> <td>5</td> <td>25±2</td> </tr> </tbody> </table> <p>•Pretreatment Perform a heat treatment at 150±9₀°C for 60±5 min. and then let sit for 24±2 hrs. at room condition.*</p> | Step | Temperature (°C) | 1 | 25±2 | 2 | Min. Operating Temp.±3 | 3 | 25±2 | 4 |
| Step | Temperature (°C) | | | | | | | | | | | |
| 1 | 25±2 | | | | | | | | | | | |
| 2 | Min. Operating Temp.±3 | | | | | | | | | | | |
| 3 | 25±2 | | | | | | | | | | | |
| 4 | Max. Operating Temp.±2 | | | | | | | | | | | |
| 5 | 25±2 | | | | | | | | | | | |
| 9 | Adhesive Strength of Termination | No removal of the terminations or other defect should occur. | Solder the capacitor to the testing jig (glass epoxy board) shown in Fig. 1. Then apply 10N force in the direction of the arrow. The soldering should be done using the reflow method and should be conducted with care so that the soldering is uniform and free of defects such as heat shock. | | | | | | | | | |
| | | |  <p style="text-align: center;">Fig. 1</p> | | | | | | | | | |
| 10 | Vibration Resistance | Appearance | No defects or abnormalities | | | | | | | | | |
| | | Capacitance | Within the specified tolerance | | | | | | | | | |
| | | D.F. | 0.025 max. | | | | | | | | | |
| | | | Solder the capacitor to the test jig (glass epoxy board). The capacitor should be subjected to a simple harmonic motion having a total amplitude of 1.5mm, the frequency being varied uniformly between the approximate limits of 10 and 55Hz. The frequency range, from 10 to 55Hz and return to 10Hz, should be traversed in approximately 1 min. This motion should be applied for a period of 2 hrs. in each of 3 mutually perpendicular directions (total of 6 hrs.). | | | | | | | | | |
| | | |  | | | | | | | | | |

* "Room condition" Temperature: 15 to 35°C, Relative humidity: 45 to 75%, Atmospheric pressure: 86 to 106kPa

Continued on the following page.

For General Purpose GRM/GRJ/GR3 Series

Only for Applications

AC250V Type GA2 Series

Safety Standard Certified GA3 Series

Product Information

GRM Series Specifications and Test Methods

Continued from the preceding page.

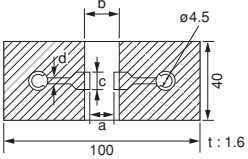
| No. | Item | Specifications | Test Method | | | | | | | | | | | | | | | | | | | | | | | | | | | | | | | | |
|----------|------------------------------|--|---|---|----------------|--|--|--|--|---|---|---|---|---------|-----|-----|-----|-----|----------|-----|-----|------|---------|-----|-----|-----|---------|-----|-----|-----|---------|-----|-----|-----|---------|
| 11 | Deflection | No marking defects | Solder the capacitor to the testing jig (glass epoxy board) shown in Fig. 2. Then apply a force in the direction shown in Fig. 3. The soldering should be done using the reflow method and should be conducted with care so that the soldering is uniform and free of defects such as heat shock. | | | | | | | | | | | | | | | | | | | | | | | | | | | | | | | | |
| | |  <p>Fig. 2</p> <table border="1"> <thead> <tr> <th>L×W (mm)</th> <th colspan="4">Dimension (mm)</th> </tr> <tr> <th></th> <th>a</th> <th>b</th> <th>c</th> <th>d</th> </tr> </thead> <tbody> <tr> <td>1.6×0.8</td> <td>1.0</td> <td>3.0</td> <td>1.2</td> <td rowspan="6">1.0</td> </tr> <tr> <td>2.0×1.25</td> <td>1.2</td> <td>4.0</td> <td>1.65</td> </tr> <tr> <td>3.2×1.6</td> <td>2.2</td> <td>5.0</td> <td>2.0</td> </tr> <tr> <td>3.2×2.5</td> <td>2.2</td> <td>5.0</td> <td>2.9</td> </tr> <tr> <td>4.5×3.2</td> <td>3.5</td> <td>7.0</td> <td>3.7</td> </tr> <tr> <td>5.7×5.0</td> <td>4.5</td> <td>8.0</td> <td>5.6</td> </tr> </tbody> </table> | | L×W (mm) | Dimension (mm) | | | | | a | b | c | d | 1.6×0.8 | 1.0 | 3.0 | 1.2 | 1.0 | 2.0×1.25 | 1.2 | 4.0 | 1.65 | 3.2×1.6 | 2.2 | 5.0 | 2.0 | 3.2×2.5 | 2.2 | 5.0 | 2.9 | 4.5×3.2 | 3.5 | 7.0 | 3.7 | 5.7×5.0 |
| L×W (mm) | Dimension (mm) | | | | | | | | | | | | | | | | | | | | | | | | | | | | | | | | | | |
| | a | b | c | d | | | | | | | | | | | | | | | | | | | | | | | | | | | | | | | |
| 1.6×0.8 | 1.0 | 3.0 | 1.2 | 1.0 | | | | | | | | | | | | | | | | | | | | | | | | | | | | | | | |
| 2.0×1.25 | 1.2 | 4.0 | 1.65 | | | | | | | | | | | | | | | | | | | | | | | | | | | | | | | | |
| 3.2×1.6 | 2.2 | 5.0 | 2.0 | | | | | | | | | | | | | | | | | | | | | | | | | | | | | | | | |
| 3.2×2.5 | 2.2 | 5.0 | 2.9 | | | | | | | | | | | | | | | | | | | | | | | | | | | | | | | | |
| 4.5×3.2 | 3.5 | 7.0 | 3.7 | | | | | | | | | | | | | | | | | | | | | | | | | | | | | | | | |
| 5.7×5.0 | 4.5 | 8.0 | 5.6 | | | | | | | | | | | | | | | | | | | | | | | | | | | | | | | | |
| 12 | Solderability of Termination | 75% of the terminations are to be soldered evenly and continuously. | Immerse the capacitor in a solution of ethanol (JIS-K-8101) and rosin (JIS-K-5902) (25% rosin in weight proportion). Immerse in solder solution for 2±0.5 sec. Immersing speed: 25±2.5mm/s Temp. of solder: 245±5°C Lead Free Solder (Sn-3.0Ag-0.5Cu) 235±5°C H60A or H63A Eutectic Solder | | | | | | | | | | | | | | | | | | | | | | | | | | | | | | | | |
| 13 | Resistance to Soldering Heat | Appearance | No marking defects | Preheat the capacitor at 120 to 150°C* for 1 min. Immerse the capacitor in solder solution at 260±5°C for 10±1 sec. Let sit at room condition* for 24±2 hrs., then measure. •Immersing speed: 25±2.5mm/s •Pretreatment Perform a heat treatment at 150±18°C for 60±5 min. and then let sit for 24±2 hrs. at room condition.* *Preheating for more than 3.2×2.5mm | | | | | | | | | | | | | | | | | | | | | | | | | | | | | | | |
| | | Capacitance Change | Within ±10% | | | | | | | | | | | | | | | | | | | | | | | | | | | | | | | | |
| | | D.F. | 0.025 max. | | | | | | | | | | | | | | | | | | | | | | | | | | | | | | | | |
| | | I.R. | C≥0.01μF: More than 100MΩ • μF C<0.01μF: More than 10,000MΩ | | | | | | | | | | | | | | | | | | | | | | | | | | | | | | | | |
| | | Dielectric Strength | In accordance with item No.4 | | | | | | | | | | | | | | | | | | | | | | | | | | | | | | | | |
| 14 | Temperature Cycle | Appearance | No marking defects | Fix the capacitor to the supporting jig (glass epoxy board) shown in Fig. 4. Perform the 5 cycles according to the 4 heat treatments listed in the following table. Let sit for 24±2 hrs. at room condition,* then measure. | | | | | | | | | | | | | | | | | | | | | | | | | | | | | | | |
| | | Capacitance Change | Within ±7.5% | | | | | | | | | | | | | | | | | | | | | | | | | | | | | | | | |
| | | D.F. | 0.025 max. | | | | | | | | | | | | | | | | | | | | | | | | | | | | | | | | |
| | | I.R. | C≥0.01μF: More than 100MΩ • μF C<0.01μF: More than 10,000MΩ | | | | | | | | | | | | | | | | | | | | | | | | | | | | | | | | |
| | | Dielectric Strength | In accordance with item No.4 | | | | | | | | | | | | | | | | | | | | | | | | | | | | | | | | |
| 15 | Humidity (Steady State) | Appearance | No marking defects | Let the capacitor sit at 40±2°C and relative humidity of 90 to 95% for 500±23hrs. Remove and let sit for 24±2 hrs. at room condition,* then measure. •Pretreatment Perform a heat treatment at 150±18°C for 60±5 min. and then let sit for 24±2 hrs. at room condition.* | | | | | | | | | | | | | | | | | | | | | | | | | | | | | | | |
| | | Capacitance Change | Within ±15% | | | | | | | | | | | | | | | | | | | | | | | | | | | | | | | | |
| | | D.F. | 0.05 max. | | | | | | | | | | | | | | | | | | | | | | | | | | | | | | | | |
| | | I.R. | C≥0.01μF: More than 10MΩ • μF C<0.01μF: More than 1,000MΩ | | | | | | | | | | | | | | | | | | | | | | | | | | | | | | | | |
| | | Dielectric Strength | In accordance with item No.4 | | | | | | | | | | | | | | | | | | | | | | | | | | | | | | | | |

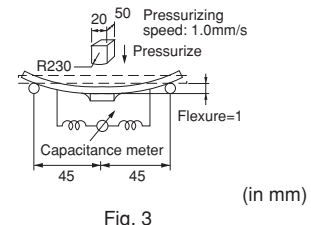

Immerse the capacitor in a solution of ethanol (JIS-K-8101) and rosin (JIS-K-5902) (25% rosin in weight proportion). Immerse in solder solution for 2±0.5 sec. Immersing speed: 25±2.5mm/s Temp. of solder: 245±5°C Lead Free Solder (Sn-3.0Ag-0.5Cu) 235±5°C H60A or H63A Eutectic Solder

Preheat the capacitor at 120 to 150°C* for 1 min. Immerse the capacitor in solder solution at 260±5°C for 10±1 sec. Let sit at room condition* for 24±2 hrs., then measure.

- Immersing speed: 25±2.5mm/s
- Pretreatment

Perform a heat treatment at 150±18°C for 60±5 min. and then let sit for 24±2 hrs. at room condition.*

*Preheating for more than 3.2×2.5mm

| Step | Temperature | Time |
|------|--------------|--------|
| 1 | 100 to 120°C | 1 min. |
| 2 | 170 to 200°C | 1 min. |

Fix the capacitor to the supporting jig (glass epoxy board) shown in Fig. 4. Perform the 5 cycles according to the 4 heat treatments listed in the following table. Let sit for 24±2 hrs. at room condition,* then measure.

| Step | Temperature (°C) | Time (min.) |
|------|------------------------|-------------|
| 1 | Min. Operating Temp.±3 | 30±3 |
| 2 | Room Temp. | 2 to 3 |
| 3 | Max. Operating Temp.±2 | 30±3 |
| 4 | Room Temp. | 2 to 3 |

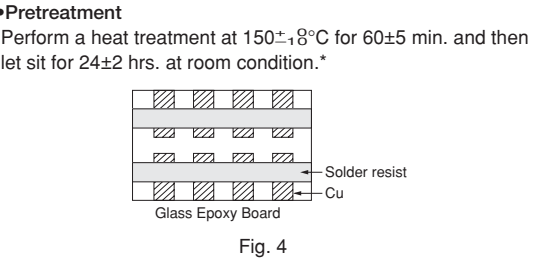

* "Room condition" Temperature: 15 to 35°C, Relative humidity: 45 to 75%, Atmospheric pressure: 86 to 106kPa

Continued on the following page. ↗

For General Purpose GRM/GRU/GR3 Series

Only for Applications

AC250V Type GA2 Series

Safety Standard Certified GA3 Series

Product Information

GRM Series Specifications and Test Methods

↳ Continued from the preceding page.

| No. | Item | Specifications | Test Method | |
|-----|--|---------------------|---|--|
| 16 | Life | Appearance | No marking defects | Apply 120% of the rated voltage (150% of the rated voltage in case of rated voltage: DC250V, 110% of the rated voltage in case of rated voltage: DC1kV) for 1,000±48hrs. at maximum operating temperature ±3°C. Remove and let sit for 24±2hrs. at room condition,* then measure. The charge/discharge current is less than 50mA. •Pretreatment Apply test voltage for 60±5 min. at test temperature. Remove and let sit for 24±2 hrs. at room condition.* |
| | | Capacitance Change | Within ±15% (rated voltage: DC250V, DC630V) Within ±20% (rated voltage: DC1kV) | |
| | | D.F. | 0.05 max. | |
| | | I.R. | C≥0.01μF: More than 10MΩ • μF C<0.01μF: More than 1,000MΩ | |
| | | Dielectric Strength | In accordance with item No.4 | |
| 17 | Humidity Loading (Application: DC250V, DC630V item) | Appearance | No marking defects | Apply the rated voltage at 40±2°C and relative humidity of 90 to 95% for 500±24hrs. Remove and let sit for 24±2 hrs. at room condition,* then measure. •Pretreatment Apply test voltage for 60±5 min. at test temperature. Remove and let sit for 24±2 hrs. at room condition.* |
| | | Capacitance Change | Within ±15% | |
| | | D.F. | 0.05 max. | |
| | | I.R. | C≥0.01μF: More than 10MΩ • μF C<0.01μF: More than 1,000MΩ | |
| | | Dielectric Strength | In accordance with item No.4 | |

* "Room condition" Temperature: 15 to 35°C, Relative humidity: 45 to 75%, Atmospheric pressure: 86 to 106kPa

For General Purpose
GRM/GRJ/GR3 Series

Only for Applications

AC250V Type
GA2 Series

Safety Standard
Certified GA3 Series

Product Information

Chip Monolithic Ceramic Capacitors (Medium Voltage)

Soft Termination Type GRJ Series

Deflecting crack

■ Features

1. Improves endurance against Board Bending Stress.
2. Reduces the board bending stress by the conductive polymer termination.
3. Use the GRJ21/31 types with flow or reflow soldering, and other types with reflow soldering only.

■ Applications

1. Ideal for use on clamp-snubber circuits for switching power supplies.
2. Ideal for use as primary-secondary coupling for DC-DC converters.
3. Ideal for use on line filters and ringer detectors for telephones, facsimiles and modems.

Do not use these products in any Automotive Power train or Safety equipment including Battery chargers for Electric Vehicles and Plug-in Hybrids. Only Murata products clearly stipulated as "for Automotive use" can be used for automobile applications such as Power train and Safety equipment.

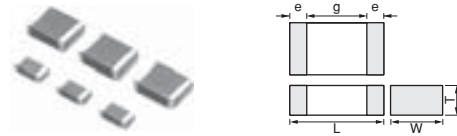

| Part Number | Dimensions (mm) | | | | |
|-------------|-----------------|-----------|--------------|----------|--------|
| | L | W | T | e | g min. |
| GRJ21A | 2.0 ±0.2 | 1.25 ±0.2 | 1.0 +0,-0.3 | 0.3 min. | 0.7 |
| GRJ21B | | | 1.25 ±0.2 | | |
| GRJ31B | 3.2 ±0.2 | 1.6 ±0.2 | 1.25 +0,-0.3 | | 1.2 |
| GRJ31C | | | 1.6 ±0.2 | | |
| GRJ32Q | 3.2 ±0.3 | 2.5 ±0.2 | 1.5 +0,-0.3 | | 2.2 |
| GRJ32D | | | 2.0 +0,-0.3 | | |
| GRJ43Q | 4.5 ±0.4 | 3.2 ±0.3 | 1.5 +0,-0.3 | | 3.2 |
| GRJ43D | | | 2.0 +0,-0.3 | | |
| GRJ55D | 5.7 ±0.4 | 5.0 ±0.4 | 2.0 +0,-0.3 | | |

| Part Number | Rated Voltage | TC Code (Standard) | Capacitance | Length L (mm) | Width W (mm) | Thickness T max. (mm) | Electrode g min. | Electrode e |
|--------------------|---------------|--------------------|-------------|---------------|--------------|-----------------------|------------------|-------------|
| GRJ21AR72E102KWJ1D | 250Vdc | X7R (EIA) | 1000pF±10% | 2 | 1.25 | 1 | 0.7mm | 0.3mm min. |
| GRJ21AR72E152KWJ1D | 250Vdc | X7R (EIA) | 1500pF±10% | 2 | 1.25 | 1 | 0.7mm | 0.3mm min. |
| GRJ21AR72E222KWJ1D | 250Vdc | X7R (EIA) | 2200pF±10% | 2 | 1.25 | 1 | 0.7mm | 0.3mm min. |
| GRJ21AR72E332KWJ1D | 250Vdc | X7R (EIA) | 3300pF±10% | 2 | 1.25 | 1 | 0.7mm | 0.3mm min. |
| GRJ21AR72E472KWJ1D | 250Vdc | X7R (EIA) | 4700pF±10% | 2 | 1.25 | 1 | 0.7mm | 0.3mm min. |
| GRJ21AR72E682KWJ1D | 250Vdc | X7R (EIA) | 6800pF±10% | 2 | 1.25 | 1 | 0.7mm | 0.3mm min. |
| GRJ21BR72E103KWJ3L | 250Vdc | X7R (EIA) | 10000pF±10% | 2 | 1.25 | 1.45 | 0.7mm | 0.3mm min. |
| GRJ21BR72E153KWJ3L | 250Vdc | X7R (EIA) | 15000pF±10% | 2 | 1.25 | 1.45 | 0.7mm | 0.3mm min. |
| GRJ31BR72E153KWJ1L | 250Vdc | X7R (EIA) | 15000pF±10% | 3.2 | 1.6 | 1.25 | 1.2mm | 0.3mm min. |
| GRJ21BR72E223KWJ3L | 250Vdc | X7R (EIA) | 22000pF±10% | 2 | 1.25 | 1.45 | 0.7mm | 0.3mm min. |
| GRJ31BR72E223KWJ1L | 250Vdc | X7R (EIA) | 22000pF±10% | 3.2 | 1.6 | 1.25 | 1.2mm | 0.3mm min. |
| GRJ31CR72E333KWJ3L | 250Vdc | X7R (EIA) | 33000pF±10% | 3.2 | 1.6 | 1.8 | 1.2mm | 0.3mm min. |
| GRJ31CR72E473KWJ3L | 250Vdc | X7R (EIA) | 47000pF±10% | 3.2 | 1.6 | 1.8 | 1.2mm | 0.3mm min. |
| GRJ31BR72E683KWJ1L | 250Vdc | X7R (EIA) | 68000pF±10% | 3.2 | 1.6 | 1.25 | 1.2mm | 0.3mm min. |
| GRJ32QR72E683KWJ1L | 250Vdc | X7R (EIA) | 68000pF±10% | 3.2 | 2.5 | 1.5 | 1.2mm | 0.3mm min. |
| GRJ31CR72E104KWJ3L | 250Vdc | X7R (EIA) | 0.10µF±10% | 3.2 | 1.6 | 1.8 | 1.2mm | 0.3mm min. |
| GRJ32DR72E104KWJ1L | 250Vdc | X7R (EIA) | 0.10µF±10% | 3.2 | 2.5 | 2 | 1.2mm | 0.3mm min. |
| GRJ32QR72E154KWJ1L | 250Vdc | X7R (EIA) | 0.15µF±10% | 3.2 | 2.5 | 1.5 | 1.2mm | 0.3mm min. |
| GRJ43QR72E154KWJ1L | 250Vdc | X7R (EIA) | 0.15µF±10% | 4.5 | 3.2 | 1.5 | 2.2mm | 0.3mm min. |
| GRJ32DR72E224KWJ1L | 250Vdc | X7R (EIA) | 0.22µF±10% | 3.2 | 2.5 | 2 | 1.2mm | 0.3mm min. |
| GRJ43DR72E224KWJ1L | 250Vdc | X7R (EIA) | 0.22µF±10% | 4.5 | 3.2 | 2 | 2.2mm | 0.3mm min. |
| GRJ43DR72E334KWJ1L | 250Vdc | X7R (EIA) | 0.33µF±10% | 4.5 | 3.2 | 2 | 2.2mm | 0.3mm min. |
| GRJ55DR72E334KWJ1L | 250Vdc | X7R (EIA) | 0.33µF±10% | 5.7 | 5 | 2 | 3.2mm | 0.3mm min. |
| GRJ43DR72E474KWJ1L | 250Vdc | X7R (EIA) | 0.47µF±10% | 4.5 | 3.2 | 2 | 2.2mm | 0.3mm min. |
| GRJ55DR72E474KWJ1L | 250Vdc | X7R (EIA) | 0.47µF±10% | 5.7 | 5 | 2 | 3.2mm | 0.3mm min. |
| GRJ55DR72E684KWJ1L | 250Vdc | X7R (EIA) | 0.68µF±10% | 5.7 | 5 | 2 | 3.2mm | 0.3mm min. |
| GRJ55DR72E105KWJ1L | 250Vdc | X7R (EIA) | 1.0µF±10% | 5.7 | 5 | 2 | 3.2mm | 0.3mm min. |

Continued on the following page. ↗

For General Purpose GRM/GRU/GR3 Series
 Only for Applications
 AC250V Type GA2 Series
 Safety Standard Certified GA3 Series
 Product Information

Continued from the preceding page.

| Part Number | Rated Voltage | TC Code (Standard) | Capacitance | Length L (mm) | Width W (mm) | Thickness T max. (mm) | Electrode g min. | Electrode e |
|--------------------|---------------|--------------------|-------------|---------------|--------------|-----------------------|------------------|-------------|
| GRJ31BR72J102KWJ1L | 630Vdc | X7R (EIA) | 1000pF±10% | 3.2 | 1.6 | 1.25 | 1.2mm | 0.3mm min. |
| GRJ31BR72J152KWJ1L | 630Vdc | X7R (EIA) | 1500pF±10% | 3.2 | 1.6 | 1.25 | 1.2mm | 0.3mm min. |
| GRJ31BR72J222KWJ1L | 630Vdc | X7R (EIA) | 2200pF±10% | 3.2 | 1.6 | 1.25 | 1.2mm | 0.3mm min. |
| GRJ31BR72J332KWJ1L | 630Vdc | X7R (EIA) | 3300pF±10% | 3.2 | 1.6 | 1.25 | 1.2mm | 0.3mm min. |
| GRJ31BR72J472KWJ1L | 630Vdc | X7R (EIA) | 4700pF±10% | 3.2 | 1.6 | 1.25 | 1.2mm | 0.3mm min. |
| GRJ31BR72J682KWJ1L | 630Vdc | X7R (EIA) | 6800pF±10% | 3.2 | 1.6 | 1.25 | 1.2mm | 0.3mm min. |
| GRJ31BR72J103KWJ1L | 630Vdc | X7R (EIA) | 10000pF±10% | 3.2 | 1.6 | 1.25 | 1.2mm | 0.3mm min. |
| GRJ31CR72J153KWJ3L | 630Vdc | X7R (EIA) | 15000pF±10% | 3.2 | 1.6 | 1.8 | 1.2mm | 0.3mm min. |
| GRJ31CR72J223KWJ3L | 630Vdc | X7R (EIA) | 22000pF±10% | 3.2 | 1.6 | 1.8 | 1.2mm | 0.3mm min. |
| GRJ32QR72J223KWJ1L | 630Vdc | X7R (EIA) | 22000pF±10% | 3.2 | 2.5 | 1.5 | 1.2mm | 0.3mm min. |
| GRJ32DR72J333KWJ1L | 630Vdc | X7R (EIA) | 33000pF±10% | 3.2 | 2.5 | 2 | 1.2mm | 0.3mm min. |
| GRJ32DR72J473KWJ1L | 630Vdc | X7R (EIA) | 47000pF±10% | 3.2 | 2.5 | 2 | 1.2mm | 0.3mm min. |
| GRJ43QR72J683KWJ1L | 630Vdc | X7R (EIA) | 68000pF±10% | 4.5 | 3.2 | 1.5 | 2.2mm | 0.3mm min. |
| GRJ43DR72J104KWJ1L | 630Vdc | X7R (EIA) | 0.10μF±10% | 4.5 | 3.2 | 2 | 2.2mm | 0.3mm min. |
| GRJ55DR72J154KWJ1L | 630Vdc | X7R (EIA) | 0.15μF±10% | 5.7 | 5 | 2 | 3.2mm | 0.3mm min. |
| GRJ55DR72J224KWJ1L | 630Vdc | X7R (EIA) | 0.22μF±10% | 5.7 | 5 | 2 | 3.2mm | 0.3mm min. |
| GRJ31BR73A471KWJ1L | 1000Vdc | X7R (EIA) | 470pF±10% | 3.2 | 1.6 | 1.25 | 1.2mm | 0.3mm min. |
| GRJ31BR73A681KWJ1L | 1000Vdc | X7R (EIA) | 680pF±10% | 3.2 | 1.6 | 1.25 | 1.2mm | 0.3mm min. |
| GRJ31BR73A102KWJ1L | 1000Vdc | X7R (EIA) | 1000pF±10% | 3.2 | 1.6 | 1.25 | 1.2mm | 0.3mm min. |
| GRJ31BR73A152KWJ1L | 1000Vdc | X7R (EIA) | 1500pF±10% | 3.2 | 1.6 | 1.25 | 1.2mm | 0.3mm min. |
| GRJ31BR73A222KWJ1L | 1000Vdc | X7R (EIA) | 2200pF±10% | 3.2 | 1.6 | 1.25 | 1.2mm | 0.3mm min. |
| GRJ31BR73A332KWJ1L | 1000Vdc | X7R (EIA) | 3300pF±10% | 3.2 | 1.6 | 1.25 | 1.2mm | 0.3mm min. |
| GRJ31BR73A472KWJ1L | 1000Vdc | X7R (EIA) | 4700pF±10% | 3.2 | 1.6 | 1.25 | 1.2mm | 0.3mm min. |
| GRJ31CR73A682KWJ3L | 1000Vdc | X7R (EIA) | 6800pF±10% | 3.2 | 1.6 | 1.8 | 1.2mm | 0.3mm min. |
| GRJ32QR73A682KWJ1L | 1000Vdc | X7R (EIA) | 6800pF±10% | 3.2 | 2.5 | 1.5 | 1.2mm | 0.3mm min. |
| GRJ31CR73A103KWJ3L | 1000Vdc | X7R (EIA) | 10000pF±10% | 3.2 | 1.6 | 1.8 | 1.2mm | 0.3mm min. |
| GRJ32QR73A103KWJ1L | 1000Vdc | X7R (EIA) | 10000pF±10% | 3.2 | 2.5 | 1.5 | 1.2mm | 0.3mm min. |
| GRJ32DR73A153KWJ1L | 1000Vdc | X7R (EIA) | 15000pF±10% | 3.2 | 2.5 | 2 | 1.2mm | 0.3mm min. |
| GRJ32DR73A223KWJ1L | 1000Vdc | X7R (EIA) | 22000pF±10% | 3.2 | 2.5 | 2 | 1.2mm | 0.3mm min. |
| GRJ43DR73A333KWJ1L | 1000Vdc | X7R (EIA) | 33000pF±10% | 4.5 | 3.2 | 2 | 2.2mm | 0.3mm min. |
| GRJ43DR73A473KWJ1L | 1000Vdc | X7R (EIA) | 47000pF±10% | 4.5 | 3.2 | 2 | 2.2mm | 0.3mm min. |
| GRJ55DR73A683KWJ1L | 1000Vdc | X7R (EIA) | 68000pF±10% | 5.7 | 5 | 2 | 3.2mm | 0.3mm min. |
| GRJ55DR73A104KWJ1L | 1000Vdc | X7R (EIA) | 0.10μF±10% | 5.7 | 5 | 2 | 3.2mm | 0.3mm min. |

For General Purpose GRM/GRJ/GR3 Series

Only for Applications

AC250V Type GA2 Series

Safety Standard Certified GA3 Series

Product Information

GRJ Series Specifications and Test Methods

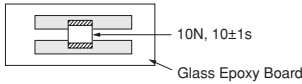
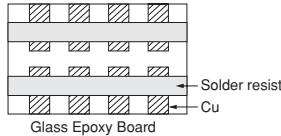
| No. | Item | Specifications | Test Method | | | | | | | | | | | | |
|---------------|---|--|--|---------------|------------------|--------|---------------------------|--------|---------------------------|-------|---------------------------|---|------------------------|---|------|
| 1 | Operating Temperature Range | -55 to +125°C | - | | | | | | | | | | | | |
| 2 | Appearance | No defects or abnormalities | Visual inspection | | | | | | | | | | | | |
| 3 | Dimensions | Within the specified dimensions | Using calipers and micrometers | | | | | | | | | | | | |
| 4 | Dielectric Strength | No defects or abnormalities | No failure should be observed when voltage in the Table is applied between the terminations for 1 to 5 sec., provided the charge/discharge current is less than 50mA. <table border="1"> <thead> <tr> <th>Rated Voltage</th> <th>Test Voltage</th> </tr> </thead> <tbody> <tr> <td>DC250V</td> <td>200% of the rated voltage</td> </tr> <tr> <td>DC630V</td> <td>150% of the rated voltage</td> </tr> <tr> <td>DC1kV</td> <td>120% of the rated voltage</td> </tr> </tbody> </table> | Rated Voltage | Test Voltage | DC250V | 200% of the rated voltage | DC630V | 150% of the rated voltage | DC1kV | 120% of the rated voltage | | | | |
| Rated Voltage | Test Voltage | | | | | | | | | | | | | | |
| DC250V | 200% of the rated voltage | | | | | | | | | | | | | | |
| DC630V | 150% of the rated voltage | | | | | | | | | | | | | | |
| DC1kV | 120% of the rated voltage | | | | | | | | | | | | | | |
| 5 | Insulation Resistance (I.R.) | C ≥ 0.01 μF: More than 100MΩ • μF C < 0.01 μF: More than 10,000MΩ | The insulation resistance should be measured with DC500±50V (DC250±25V in case of rated voltage: DC250V) and within 60±5 sec. of charging. | | | | | | | | | | | | |
| 6 | Capacitance | Within the specified tolerance | The capacitance/D.F. should be measured at a frequency of 1±0.2kHz and a voltage of AC1±0.2V(r.m.s.). | | | | | | | | | | | | |
| 7 | Dissipation Factor (D.F.) | 0.025 max. | | | | | | | | | | | | | |
| 8 | Capacitance Temperature Characteristics | Cap. Change Within ±15% (Temp. Range: -55 to +125°C) | The capacitance measurement should be made at each step specified in the Table. <table border="1"> <thead> <tr> <th>Step</th> <th>Temperature (°C)</th> </tr> </thead> <tbody> <tr> <td>1</td> <td>25±2</td> </tr> <tr> <td>2</td> <td>Min. Operating Temp.±3</td> </tr> <tr> <td>3</td> <td>25±2</td> </tr> <tr> <td>4</td> <td>Max. Operating Temp.±2</td> </tr> <tr> <td>5</td> <td>25±2</td> </tr> </tbody> </table> <p>•Pretreatment Perform a heat treatment at 150±9°C for 60±5 min. and then let sit for 24±2 hrs. at room condition.*</p> | Step | Temperature (°C) | 1 | 25±2 | 2 | Min. Operating Temp.±3 | 3 | 25±2 | 4 | Max. Operating Temp.±2 | 5 | 25±2 |
| Step | Temperature (°C) | | | | | | | | | | | | | | |
| 1 | 25±2 | | | | | | | | | | | | | | |
| 2 | Min. Operating Temp.±3 | | | | | | | | | | | | | | |
| 3 | 25±2 | | | | | | | | | | | | | | |
| 4 | Max. Operating Temp.±2 | | | | | | | | | | | | | | |
| 5 | 25±2 | | | | | | | | | | | | | | |
| 9 | Adhesive Strength of Termination | No removal of the terminations or other defect should occur. | Solder the capacitor to the testing jig (glass epoxy board) shown in Fig. 1. Then apply 10N force in the direction of the arrow. The soldering should be done using the reflow method and should be conducted with care so that the soldering is uniform and free of defects such as heat shock.  Fig. 1 | | | | | | | | | | | | |
| 10 | Vibration Resistance | Appearance | No defects or abnormalities | | | | | | | | | | | | |
| | | Capacitance | Within the specified tolerance | | | | | | | | | | | | |
| | | D.F. | 0.025 max. | | | | | | | | | | | | |
| | | | Solder the capacitor to the test jig (glass epoxy board). The capacitor should be subjected to a simple harmonic motion having a total amplitude of 1.5mm, the frequency being varied uniformly between the approximate limits of 10 and 55Hz. The frequency range, from 10 to 55Hz and return to 10Hz, should be traversed in approximately 1 min. This motion should be applied for a period of 2 hrs. in each of 3 mutually perpendicular directions (total of 6 hrs.).  | | | | | | | | | | | | |

* "Room condition" Temperature: 15 to 35°C, Relative humidity: 45 to 75%, Atmospheric pressure: 86 to 106kPa

Continued on the following page. 

For General Purpose GRM/GRU/GR3 Series
 Only for Applications
 AC250V Type GA2 Series
 Safety Standard Certified GA3 Series
 Product Information

GRJ Series Specifications and Test Methods

Continued from the preceding page.

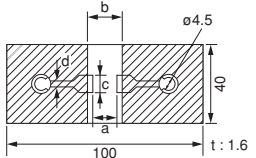
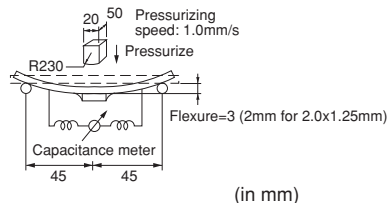
| No. | Item | Specifications | Test Method | | | | | | | | | | | | | | | | | | | | | | | | | | | | | | |
|--|------------------------------|--|---|----------------|----------------|-----|-----|-----|---|---|----------|-----|----------|------|---------|------|---------|-----|---------|-----|---------|-----|---------|-----|---------|-----|---------|-----|---------|-----|-----|-----|--|
| 11 | Appearance | No marking defects | Solder the capacitor to the testing jig (glass epoxy board) shown in Fig. 2. Then apply a force in the direction shown in Fig. 3. The soldering should be done using the reflow method and should be conducted with care so that the soldering is uniform and free of defects such as heat shock. | | | | | | | | | | | | | | | | | | | | | | | | | | | | | | |
| | Capacitance Change | Within ±12.5% | | | | | | | | | | | | | | | | | | | | | | | | | | | | | | | |
| | Deflection |  <p>Fig. 2</p> <table border="1"> <thead> <tr> <th>L×W (mm)</th> <th colspan="3">Dimension (mm)</th> <th rowspan="6">1.0</th> </tr> <tr> <th></th> <th>a</th> <th>b</th> <th>c</th> </tr> </thead> <tbody> <tr> <td>2.0×1.25</td> <td>1.2</td> <td>4.0</td> <td>1.65</td> </tr> <tr> <td>3.2×1.6</td> <td>2.2</td> <td>5.0</td> <td>2.0</td> </tr> <tr> <td>3.2×2.5</td> <td>2.2</td> <td>5.0</td> <td>2.9</td> </tr> <tr> <td>4.5×3.2</td> <td>3.5</td> <td>7.0</td> <td>3.7</td> </tr> <tr> <td>5.7×5.0</td> <td>4.5</td> <td>8.0</td> <td>5.6</td> </tr> </tbody> </table> | | L×W (mm) | Dimension (mm) | | | 1.0 | | a | b | c | 2.0×1.25 | 1.2 | 4.0 | 1.65 | 3.2×1.6 | 2.2 | 5.0 | 2.0 | 3.2×2.5 | 2.2 | 5.0 | 2.9 | 4.5×3.2 | 3.5 | 7.0 | 3.7 | 5.7×5.0 | 4.5 | 8.0 | 5.6 | |
| | | L×W (mm) | | Dimension (mm) | | | 1.0 | | | | | | | | | | | | | | | | | | | | | | | | | | |
| | | | | a | b | c | | | | | | | | | | | | | | | | | | | | | | | | | | | |
| 2.0×1.25 | | 1.2 | 4.0 | 1.65 | | | | | | | | | | | | | | | | | | | | | | | | | | | | | |
| 3.2×1.6 | 2.2 | 5.0 | 2.0 | | | | | | | | | | | | | | | | | | | | | | | | | | | | | | |
| 3.2×2.5 | 2.2 | 5.0 | 2.9 | | | | | | | | | | | | | | | | | | | | | | | | | | | | | | |
| 4.5×3.2 | 3.5 | 7.0 | 3.7 | | | | | | | | | | | | | | | | | | | | | | | | | | | | | | |
| 5.7×5.0 | 4.5 | 8.0 | 5.6 | | | | | | | | | | | | | | | | | | | | | | | | | | | | | | |
|  <p>Fig. 3 (in mm)</p> | | | | | | | | | | | | | | | | | | | | | | | | | | | | | | | | | |
| <table border="1"> <thead> <tr> <th>L×W (mm)</th> <th colspan="3">Dimension (mm)</th> <th rowspan="6">1.0</th> </tr> <tr> <th></th> <th>a</th> <th>b</th> <th>c</th> </tr> </thead> <tbody> <tr> <td>2.0×1.25</td> <td>1.2</td> <td>4.0</td> <td>1.65</td> </tr> <tr> <td>3.2×1.6</td> <td>2.2</td> <td>5.0</td> <td>2.0</td> </tr> <tr> <td>3.2×2.5</td> <td>2.2</td> <td>5.0</td> <td>2.9</td> </tr> <tr> <td>4.5×3.2</td> <td>3.5</td> <td>7.0</td> <td>3.7</td> </tr> <tr> <td>5.7×5.0</td> <td>4.5</td> <td>8.0</td> <td>5.6</td> </tr> </tbody> </table> | | L×W (mm) | Dimension (mm) | | | 1.0 | | a | b | c | 2.0×1.25 | 1.2 | 4.0 | 1.65 | 3.2×1.6 | 2.2 | 5.0 | 2.0 | 3.2×2.5 | 2.2 | 5.0 | 2.9 | 4.5×3.2 | 3.5 | 7.0 | 3.7 | 5.7×5.0 | 4.5 | 8.0 | 5.6 | | | |
| L×W (mm) | Dimension (mm) | | | 1.0 | | | | | | | | | | | | | | | | | | | | | | | | | | | | | |
| | a | b | c | | | | | | | | | | | | | | | | | | | | | | | | | | | | | | |
| 2.0×1.25 | 1.2 | 4.0 | 1.65 | | | | | | | | | | | | | | | | | | | | | | | | | | | | | | |
| 3.2×1.6 | 2.2 | 5.0 | 2.0 | | | | | | | | | | | | | | | | | | | | | | | | | | | | | | |
| 3.2×2.5 | 2.2 | 5.0 | 2.9 | | | | | | | | | | | | | | | | | | | | | | | | | | | | | | |
| 4.5×3.2 | 3.5 | 7.0 | 3.7 | | | | | | | | | | | | | | | | | | | | | | | | | | | | | | |
| 5.7×5.0 | 4.5 | 8.0 | 5.6 | | | | | | | | | | | | | | | | | | | | | | | | | | | | | | |
| 12 | Solderability of Termination | 75% of the terminations are to be soldered evenly and continuously. | Immerse the capacitor in a solution of ethanol (JIS-K-8101) and rosin (JIS-K-5902) (25% rosin in weight proportion). Immerse in solder solution for 2±0.5 sec. Immersing speed: 25±2.5mm/s Temp. of solder: 245±5°C Lead Free Solder (Sn-3.0Ag-0.5Cu) 235±5°C H60A or H63A Eutectic Solder | | | | | | | | | | | | | | | | | | | | | | | | | | | | | | |
| 13 | Appearance | No marking defects | Preheat the capacitor at 120 to 150°C* for 1 min. Immerse the capacitor in solder solution at 260±5°C for 10±1 sec. Let sit at room condition* for 24±2 hrs., then measure. •Immersing speed: 25±2.5mm/s •Pretreatment Perform a heat treatment at 150±18°C for 60±5 min. and then let sit for 24±2 hrs. at room condition.* *Preheating for more than 3.2×2.5mm | | | | | | | | | | | | | | | | | | | | | | | | | | | | | | |
| | Capacitance Change | Within ±10% | | | | | | | | | | | | | | | | | | | | | | | | | | | | | | | |
| | D.F. | 0.025 max. | | | | | | | | | | | | | | | | | | | | | | | | | | | | | | | |
| | I.R. | C≥0.01μF: More than 100MΩ • μF C<0.01μF: More than 10,000MΩ | | | | | | | | | | | | | | | | | | | | | | | | | | | | | | | |
| | Dielectric Strength | In accordance with item No.4 | | | | | | | | | | | | | | | | | | | | | | | | | | | | | | | |
| 14 | Appearance | No marking defects | Fix the capacitor to the supporting jig (glass epoxy board) shown in Fig. 4. Perform the 5 cycles according to the 4 heat treatments listed in the following table. Let sit for 24±2 hrs. at room condition,* then measure. | | | | | | | | | | | | | | | | | | | | | | | | | | | | | | |
| | Capacitance Change | Within ±7.5% | | | | | | | | | | | | | | | | | | | | | | | | | | | | | | | |
| | D.F. | 0.025 max. | | | | | | | | | | | | | | | | | | | | | | | | | | | | | | | |
| | I.R. | C≥0.01μF: More than 100MΩ • μF C<0.01μF: More than 10,000MΩ | | | | | | | | | | | | | | | | | | | | | | | | | | | | | | | |
| | Dielectric Strength | In accordance with item No.4 | | | | | | | | | | | | | | | | | | | | | | | | | | | | | | | |
| 15 | Appearance | No marking defects | Let the capacitor sit at 40±2°C and relative humidity of 90 to 95% for 500±24hrs. Remove and let sit for 24±2 hrs. at room condition,* then measure. •Pretreatment Perform a heat treatment at 150±18°C for 60±5 min. and then let sit for 24±2 hrs. at room condition.* | | | | | | | | | | | | | | | | | | | | | | | | | | | | | | |
| | Capacitance Change | Within ±15% | | | | | | | | | | | | | | | | | | | | | | | | | | | | | | | |
| | D.F. | 0.05 max. | | | | | | | | | | | | | | | | | | | | | | | | | | | | | | | |
| | I.R. | C≥0.01μF: More than 10MΩ • μF C<0.01μF: More than 1,000MΩ | | | | | | | | | | | | | | | | | | | | | | | | | | | | | | | |
| | Dielectric Strength | In accordance with item No.4 | | | | | | | | | | | | | | | | | | | | | | | | | | | | | | | |

* "Room condition" Temperature: 15 to 35°C, Relative humidity: 45 to 75%, Atmospheric pressure: 86 to 106kPa

Continued on the following page. ↗

For General Purpose GRM/GRJ/GR3 Series

Only for Applications

AC250V Type GA2 Series

Safety Standard Certified GA3 Series

Product Information

GRJ Series Specifications and Test Methods

Continued from the preceding page.

| No. | Item | Specifications | Test Method | | | | | | | | |
|---------------------|---|---------------------|--|--|-----------------|--------|---------------------------|--------|---------------------------|-------|---------------------------|
| 16 | Life | Appearance | Apply voltage as in Table for 1,000±48hrs. at maximum operating temperature ±3°C. Remove and let sit for 24±2 hrs. at room condition,* then measure. <table border="1" style="margin-left: 20px;"> <thead> <tr> <th>Rated Voltage</th> <th>Applied Voltage</th> </tr> </thead> <tbody> <tr> <td>DC250V</td> <td>150% of the rated voltage</td> </tr> <tr> <td>DC630V</td> <td>120% of the rated voltage</td> </tr> <tr> <td>DC1kV</td> <td>110% of the rated voltage</td> </tr> </tbody> </table> The charge/discharge current is less than 50mA. •Pretreatment Apply test voltage for 60±5 min. at test temperature. Remove and let sit for 24±2 hrs. at room condition.* | Rated Voltage | Applied Voltage | DC250V | 150% of the rated voltage | DC630V | 120% of the rated voltage | DC1kV | 110% of the rated voltage |
| | | Rated Voltage | | Applied Voltage | | | | | | | |
| | | DC250V | | 150% of the rated voltage | | | | | | | |
| | | DC630V | | 120% of the rated voltage | | | | | | | |
| | | DC1kV | | 110% of the rated voltage | | | | | | | |
| Capacitance Change | Within ±15% (rated voltage: DC250V, DC630V) Within ±20% (rated voltage: DC1kV) | | | | | | | | | | |
| D.F. | 0.05 max. | | | | | | | | | | |
| I.R. | C≥0.01μF: More than 10MΩ • μF C<0.01μF: More than 1,000MΩ | | | | | | | | | | |
| Dielectric Strength | In accordance with item No.4 | | | | | | | | | | |
| 17 | Humidity Loading (Application: DC250V, DC630V item) | Appearance | Apply the rated voltage at 40±2°C and relative humidity of 90 to 95% for 500±24hrs. Remove and let sit for 24±2 hrs. at room condition,* then measure. •Pretreatment Apply test voltage for 60±5 min. at test temperature. Remove and let sit for 24±2 hrs. at room condition.* | | | | | | | | |
| | | Capacitance Change | | Within ±15% | | | | | | | |
| | | D.F. | | 0.05 max. | | | | | | | |
| | | I.R. | | C≥0.01μF: More than 10MΩ • μF C<0.01μF: More than 1,000MΩ | | | | | | | |
| | | Dielectric Strength | | In accordance with item No.4 | | | | | | | |

* "Room condition" Temperature: 15 to 35°C, Relative humidity: 45 to 75%, Atmospheric pressure: 86 to 106kPa

For General Purpose GRM/GRU/GR3 Series
 Only for Applications
 AC250V Type GA2 Series
 Safety Standard Certified GA3 Series
 Product Information

Chip Monolithic Ceramic Capacitors (Medium Voltage)

Large Capacitance and High Allowable Ripple Current GR3 Series

Anti-noise

■ Features

1. This series can provide higher capacitance value under DC-Bias condition, compare with previous X7R char.
2. Improve the performance of ripple-resistance compared with X7R char.
3. Reduce acoustic noise.
4. High reliability for board bending stress
5. Sn-plated external electrodes provide good soldering, and other types with reflow soldering only.
6. Use the GR321/331 types with flow or reflow soldering, and other types with reflow soldering only.

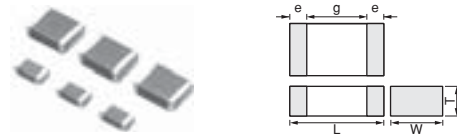

| Part Number | Dimensions (mm) | | | | | |
|-------------|-----------------|----------|-------------|----------|--------|-----|
| | L | W | T | e | g min. | |
| GR321A | 2.0±0.2 | 1.25±0.2 | 1.0+0,-0.3 | 0.3 min. | 0.7 | |
| GR321B | | | 1.25±0.2 | | | |
| GR331A | 3.2±0.2 | 1.6±0.2 | 1.0+0,-0.3 | | 1.2 | |
| GR331B | | | 1.25+0,-0.3 | | | |
| GR331C | | | 1.6±0.2 | | | |
| GR332Q | | | 1.5+0,-0.3 | | | |
| GR332D | 3.2±0.3 | 2.5±0.2 | 2.0+0,-0.3 | | | 2.2 |
| GR343Q | 4.5±0.4 | 3.2±0.3 | 1.5+0,-0.3 | | | |
| GR343D | 5.7±0.4 | 5.0±0.4 | 2.0+0,-0.3 | | 3.2 | |
| GR355D | | | 2.0+0,-0.3 | | | |
| GR355X | | | 2.7+0,-0.3 | | | |

■ Applications

1. DC smoothing & EMI filter for LED Lighting.
2. For PFC circuit in the switching power supplies, AC adaptor.
3. DC-DC converter for general electronic equipment.

Do not use these products in any Automotive Power train or Safety equipment including Battery chargers for Electric Vehicles and Plug-in Hybrids. Only Murata products clearly stipulated as "for Automotive use" can be used for automobile applications such as Power train and Safety equipment.

| Part Number | Rated Voltage | TC Code (Standard) | Capacitance | Length L (mm) | Width W (mm) | Thickness T max. (mm) | Electrode g min. | Electrode e |
|--------------------|---------------|--------------------|-------------|---------------|--------------|-----------------------|------------------|-------------|
| GR321AD72E103KW01D | 250Vdc | X7T (EIA) | 10000pF±10% | 2 | 1.25 | 1 | 0.7mm | 0.3mm min. |
| GR321AD72E153KW01D | 250Vdc | X7T (EIA) | 15000pF±10% | 2 | 1.25 | 1 | 0.7mm | 0.3mm min. |
| GR321BD72E223KW03L | 250Vdc | X7T (EIA) | 22000pF±10% | 2 | 1.25 | 1.45 | 0.7mm | 0.3mm min. |
| GR331AD72E333KW01D | 250Vdc | X7T (EIA) | 33000pF±10% | 3.2 | 1.6 | 1 | 1.2mm | 0.3mm min. |
| GR331BD72E473KW01L | 250Vdc | X7T (EIA) | 47000pF±10% | 3.2 | 1.6 | 1.25 | 1.2mm | 0.3mm min. |
| GR331CD72E683KW03L | 250Vdc | X7T (EIA) | 68000pF±10% | 3.2 | 1.6 | 1.8 | 1.2mm | 0.3mm min. |
| GR332QD72E104KW01L | 250Vdc | X7T (EIA) | 0.10µF±10% | 3.2 | 2.5 | 1.5 | 1.2mm | 0.3mm min. |
| GR332DD72E154KW01L | 250Vdc | X7T (EIA) | 0.15µF±10% | 3.2 | 2.5 | 2 | 1.2mm | 0.3mm min. |
| GR343QD72E224KW01L | 250Vdc | X7T (EIA) | 0.22µF±10% | 4.5 | 3.2 | 1.5 | 2.2mm | 0.3mm min. |
| GR343DD72E334KW01L | 250Vdc | X7T (EIA) | 0.33µF±10% | 4.5 | 3.2 | 2 | 2.2mm | 0.3mm min. |
| GR355DD72E474KW01L | 250Vdc | X7T (EIA) | 0.47µF±10% | 5.7 | 5.0 | 2 | 3.2mm | 0.3mm min. |
| GR355DD72E684KW01L | 250Vdc | X7T (EIA) | 0.68µF±10% | 5.7 | 5.0 | 2 | 3.2mm | 0.3mm min. |
| GR355XD72E105KW05L | 250Vdc | X7T (EIA) | 1.0µF±10% | 5.7 | 5.0 | 2.7 | 3.2mm | 0.3mm min. |
| GR331AD72W103KW01D | 450Vdc | X7T (EIA) | 10000pF±10% | 3.2 | 1.6 | 1 | 1.2mm | 0.3mm min. |
| GR331AD72W153KW01D | 450Vdc | X7T (EIA) | 15000pF±10% | 3.2 | 1.6 | 1 | 1.2mm | 0.3mm min. |
| GR331BD72W223KW01L | 450Vdc | X7T (EIA) | 22000pF±10% | 3.2 | 1.6 | 1.25 | 1.2mm | 0.3mm min. |
| GR331BD72W333KW01L | 450Vdc | X7T (EIA) | 33000pF±10% | 3.2 | 1.6 | 1.25 | 1.2mm | 0.3mm min. |
| GR331CD72W473KW03L | 450Vdc | X7T (EIA) | 47000pF±10% | 3.2 | 1.6 | 1.8 | 1.2mm | 0.3mm min. |
| GR332DD72W683KW01L | 450Vdc | X7T (EIA) | 68000pF±10% | 3.2 | 2.5 | 2 | 1.2mm | 0.3mm min. |
| GR332DD72W104KW01L | 450Vdc | X7T (EIA) | 0.10µF±10% | 3.2 | 2.5 | 2 | 1.2mm | 0.3mm min. |
| GR343DD72W154KW01L | 450Vdc | X7T (EIA) | 0.15µF±10% | 4.5 | 3.2 | 2 | 2.2mm | 0.3mm min. |
| GR355DD72W224KW01L | 450Vdc | X7T (EIA) | 0.22µF±10% | 5.7 | 5.0 | 2 | 3.2mm | 0.3mm min. |
| GR355DD72W334KW01L | 450Vdc | X7T (EIA) | 0.33µF±10% | 5.7 | 5.0 | 2 | 3.2mm | 0.3mm min. |
| GR355DD72W474KW01L | 450Vdc | X7T (EIA) | 0.47µF±10% | 5.7 | 5.0 | 2 | 3.2mm | 0.3mm min. |
| GR355XD72W564KW05L | 450Vdc | X7T (EIA) | 0.56µF±10% | 5.7 | 5.0 | 2.7 | 3.2mm | 0.3mm min. |

Continued on the following page.

Continued from the preceding page.

| Part Number | Rated Voltage | TC Code (Standard) | Capacitance | Length L (mm) | Width W (mm) | Thickness T max. (mm) | Electrode g min. | Electrode e |
|--------------------|---------------|--------------------|-------------|---------------|--------------|-----------------------|------------------|-------------|
| GR331BD72J103KW01L | 630Vdc | X7T (EIA) | 10000pF±10% | 3.2 | 1.6 | 1.25 | 1.2mm | 0.3mm min. |
| GR331CD72J153KW03L | 630Vdc | X7T (EIA) | 15000pF±10% | 3.2 | 1.6 | 1.8 | 1.2mm | 0.3mm min. |
| GR332QD72J223KW01L | 630Vdc | X7T (EIA) | 22000pF±10% | 3.2 | 2.5 | 1.5 | 1.2mm | 0.3mm min. |
| GR332DD72J333KW01L | 630Vdc | X7T (EIA) | 33000pF±10% | 3.2 | 2.5 | 2 | 1.2mm | 0.3mm min. |
| GR332DD72J473KW01L | 630Vdc | X7T (EIA) | 47000pF±10% | 3.2 | 2.5 | 2 | 1.2mm | 0.3mm min. |
| GR343DD72J683KW01L | 630Vdc | X7T (EIA) | 68000pF±10% | 4.5 | 3.2 | 2 | 2.2mm | 0.3mm min. |
| GR355DD72J104KW01L | 630Vdc | X7T (EIA) | 0.1μF±10% | 5.7 | 5.0 | 2 | 3.2mm | 0.3mm min. |
| GR355DD72J154KW01L | 630Vdc | X7T (EIA) | 0.15μF±10% | 5.7 | 5.0 | 2 | 3.2mm | 0.3mm min. |
| GR355XD72J224KW05L | 630Vdc | X7T (EIA) | 0.22μF±10% | 5.7 | 5.0 | 2.7 | 3.2mm | 0.3mm min. |
| GR355XD72J274KW05L | 630Vdc | X7T (EIA) | 0.27μF±10% | 5.7 | 5.0 | 2.7 | 3.2mm | 0.3mm min. |

For General Purpose GRM/GRU/GR3 Series

Only for Applications

AC250V Type GA2 Series

Safety Standard Certified GA3 Series

Product Information

GR3 Series Specifications and Test Methods

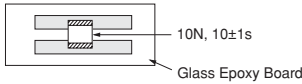
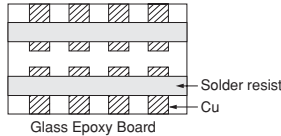
| No. | Item | Specifications | Test Method | | | | | | | | | | | | |
|---------------|---|--|--|---------------|------------------|--------|---------------------------|--------|---------------------------|--------|---------------------------|---|------------------------|---|------|
| 1 | Operating Temperature Range | -55 to +125°C | - | | | | | | | | | | | | |
| 2 | Appearance | No defects or abnormalities | Visual inspection | | | | | | | | | | | | |
| 3 | Dimensions | Within the specified dimensions | Using calipers and micrometers | | | | | | | | | | | | |
| 4 | Dielectric Strength | No defects or abnormalities | No failure should be observed when voltage in Table is applied between the terminations for 1 to 5 sec., provided the charge/discharge current is less than 50mA. <table border="1" style="margin-left: auto; margin-right: auto; border-collapse: collapse;"> <thead> <tr style="background-color: #f2f2f2;"> <th>Rated Voltage</th> <th>Test Voltage</th> </tr> </thead> <tbody> <tr> <td>DC250V</td> <td>200% of the rated voltage</td> </tr> <tr> <td>DC450V</td> <td>150% of the rated voltage</td> </tr> <tr> <td>DC630V</td> <td>120% of the rated voltage</td> </tr> </tbody> </table> | Rated Voltage | Test Voltage | DC250V | 200% of the rated voltage | DC450V | 150% of the rated voltage | DC630V | 120% of the rated voltage | | | | |
| Rated Voltage | Test Voltage | | | | | | | | | | | | | | |
| DC250V | 200% of the rated voltage | | | | | | | | | | | | | | |
| DC450V | 150% of the rated voltage | | | | | | | | | | | | | | |
| DC630V | 120% of the rated voltage | | | | | | | | | | | | | | |
| 5 | Insulation Resistance (I.R.) | More than 10,000MΩ or 100MΩ • μF (Whichever is smaller) | The insulation resistance should be measured with DC500±50V (DC250±25V in case of rated voltage: DC250V, DC450V) and within 60±5 sec. of charging. | | | | | | | | | | | | |
| 6 | Capacitance | Within the specified tolerance | The capacitance/D.F. should be measured at a frequency of 1±0.2kHz and a voltage of AC1±0.2V(r.m.s.). | | | | | | | | | | | | |
| 7 | Dissipation Factor (D.F.) | 0.01 max. | | | | | | | | | | | | | |
| 8 | Capacitance Temperature Characteristics | Cap. Change Within ±3% (Temp. Range: -55 to +125°C) | The capacitance measurement should be made at each step specified in the Table. <table border="1" style="margin-left: auto; margin-right: auto; border-collapse: collapse;"> <thead> <tr style="background-color: #f2f2f2;"> <th>Step</th> <th>Temperature (°C)</th> </tr> </thead> <tbody> <tr> <td>1</td> <td>25±2</td> </tr> <tr> <td>2</td> <td>Min. Operating Temp.±3</td> </tr> <tr> <td>3</td> <td>25±2</td> </tr> <tr> <td>4</td> <td>Max. Operating Temp.±2</td> </tr> <tr> <td>5</td> <td>25±2</td> </tr> </tbody> </table> <p>•Pretreatment Perform a heat treatment at 150±9°C for 60±5 min. and then let sit for 24±2 hrs. at room condition.*</p> | Step | Temperature (°C) | 1 | 25±2 | 2 | Min. Operating Temp.±3 | 3 | 25±2 | 4 | Max. Operating Temp.±2 | 5 | 25±2 |
| Step | Temperature (°C) | | | | | | | | | | | | | | |
| 1 | 25±2 | | | | | | | | | | | | | | |
| 2 | Min. Operating Temp.±3 | | | | | | | | | | | | | | |
| 3 | 25±2 | | | | | | | | | | | | | | |
| 4 | Max. Operating Temp.±2 | | | | | | | | | | | | | | |
| 5 | 25±2 | | | | | | | | | | | | | | |
| 9 | Adhesive Strength of Termination | No removal of the terminations or other defect should occur. | Solder the capacitor to the testing jig (glass epoxy board) shown in Fig. 1. Then apply 10N force in the direction of the arrow. The soldering should be done using the reflow method and should be conducted with care so that the soldering is uniform and free of defects such as heat shock. <div style="text-align: center;">  <p>10N, 10±1s Glass Epoxy Board</p> <p>Fig. 1</p> </div> | | | | | | | | | | | | |
| 10 | Vibration Resistance | Appearance | No defects or abnormalities | | | | | | | | | | | | |
| | | Capacitance | Within the specified tolerance | | | | | | | | | | | | |
| | | D.F. | 0.01 max. | | | | | | | | | | | | |
| | | | Solder the capacitor to the test jig (glass epoxy board). The capacitor should be subjected to a simple harmonic motion having a total amplitude of 1.5mm, the frequency being varied uniformly between the approximate limits of 10 and 55Hz. The frequency range, from 10 to 55Hz and return to 10Hz, should be traversed in approximately 1 min. This motion should be applied for a period of 2 hrs. in each of 3 mutually perpendicular directions (total of 6 hrs.). <div style="text-align: center;">  <p>Solder resist Cu Glass Epoxy Board</p> </div> | | | | | | | | | | | | |

* "Room condition" Temperature: 15 to 35°C, Relative humidity: 45 to 75%, Atmospheric pressure: 86 to 106kPa

Continued on the following page.

For General Purpose GRM/GRJ/GR3 Series

Only for Applications

AC250V Type GA2 Series

Safety Standard Certified GA3 Series

Product Information

GR3 Series Specifications and Test Methods

Continued from the preceding page.

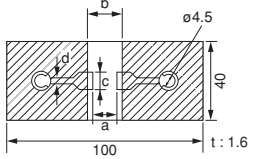
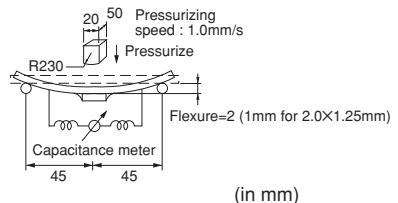
| No. | Item | Specifications | Test Method | | | | | | | | | | | | | | | | | | | | | | | | | | | | |
|----------|------------------------------|---|---|---|----------------|--|--|--|--|---|---|---|---|----------|-----|-----|------|-----|---------|-----|-----|-----|---------|-----|-----|-----|---------|-----|-----|-----|---------|
| 11 | Deflection | No marking defects | Solder the capacitor to the testing jig (glass epoxy board) shown in Fig. 2. Then apply a force in the direction shown in Fig. 3. The soldering should be done using the reflow method and should be conducted with care so that the soldering is uniform and free of defects such as heat shock. | | | | | | | | | | | | | | | | | | | | | | | | | | | | |
| | |  <p>Fig. 2</p> <table border="1"> <thead> <tr> <th>L×W (mm)</th> <th colspan="4">Dimension (mm)</th> </tr> <tr> <th></th> <th>a</th> <th>b</th> <th>c</th> <th>d</th> </tr> </thead> <tbody> <tr> <td>2.0×1.25</td> <td>1.2</td> <td>4.0</td> <td>1.65</td> <td rowspan="5">1.0</td> </tr> <tr> <td>3.2×1.6</td> <td>2.2</td> <td>5.0</td> <td>2.0</td> </tr> <tr> <td>3.2×2.5</td> <td>2.2</td> <td>5.0</td> <td>2.9</td> </tr> <tr> <td>4.5×3.2</td> <td>3.5</td> <td>7.0</td> <td>3.7</td> </tr> <tr> <td>5.7×5.0</td> <td>4.5</td> <td>8.0</td> <td>5.6</td> </tr> </tbody> </table> | | L×W (mm) | Dimension (mm) | | | | | a | b | c | d | 2.0×1.25 | 1.2 | 4.0 | 1.65 | 1.0 | 3.2×1.6 | 2.2 | 5.0 | 2.0 | 3.2×2.5 | 2.2 | 5.0 | 2.9 | 4.5×3.2 | 3.5 | 7.0 | 3.7 | 5.7×5.0 |
| L×W (mm) | Dimension (mm) | | | | | | | | | | | | | | | | | | | | | | | | | | | | | | |
| | a | b | c | d | | | | | | | | | | | | | | | | | | | | | | | | | | | |
| 2.0×1.25 | 1.2 | 4.0 | 1.65 | 1.0 | | | | | | | | | | | | | | | | | | | | | | | | | | | |
| 3.2×1.6 | 2.2 | 5.0 | 2.0 | | | | | | | | | | | | | | | | | | | | | | | | | | | | |
| 3.2×2.5 | 2.2 | 5.0 | 2.9 | | | | | | | | | | | | | | | | | | | | | | | | | | | | |
| 4.5×3.2 | 3.5 | 7.0 | 3.7 | | | | | | | | | | | | | | | | | | | | | | | | | | | | |
| 5.7×5.0 | 4.5 | 8.0 | 5.6 | | | | | | | | | | | | | | | | | | | | | | | | | | | | |
| | | |  <p>Fig. 3 (in mm)</p> | | | | | | | | | | | | | | | | | | | | | | | | | | | | |
| 12 | Solderability of Termination | 75% of the terminations are to be soldered evenly and continuously. | Immerse the capacitor in a solution of ethanol (JIS-K-8101) and rosin (JIS-K-5902) (25% rosin in weight proportion). Immerse in solder solution for 2±0.5 sec. Immersing speed: 25±2.5mm/s Temp. of solder: 245±5°C Lead Free Solder (Sn-3.0Ag-0.5Cu) 235±5°C H60A or H63A Eutectic Solder | | | | | | | | | | | | | | | | | | | | | | | | | | | | |
| 13 | Resistance to Soldering Heat | Appearance | No marking defects | Preheat the capacitor at 120 to 150°C* for 1 min. Immerse the capacitor in solder solution at 260±5°C for 10±1 sec. Let sit at room condition* for 24±2 hrs., then measure. •Immersing speed: 25±2.5mm/s •Pretreatment Perform a heat treatment at 150±10°C for 60±5 min. and then let sit for 24±2 hrs. at room condition.* *Preheating for more than 3.2×2.5mm | | | | | | | | | | | | | | | | | | | | | | | | | | | |
| | | Capacitance Change | Within ±10% | | | | | | | | | | | | | | | | | | | | | | | | | | | | |
| | | D.F. | 0.01 max. | | | | | | | | | | | | | | | | | | | | | | | | | | | | |
| | | I.R. | More than 10,000MΩ or 100MΩ • μF (Whichever is smaller) | | | | | | | | | | | | | | | | | | | | | | | | | | | | |
| | | Dielectric Strength | In accordance with item No.4 | | | | | | | | | | | | | | | | | | | | | | | | | | | | |
| 14 | Temperature Cycle | Appearance | No marking defects | Fix the capacitor to the supporting jig (glass epoxy board) shown in Fig. 4. Perform the 5 cycles according to the 4 heat treatments listed in the following table. Let sit for 24±2 hrs. at room condition,* then measure. | | | | | | | | | | | | | | | | | | | | | | | | | | | |
| | | Capacitance Change | Within ±7.5% | | | | | | | | | | | | | | | | | | | | | | | | | | | | |
| | | D.F. | 0.01 max. | | | | | | | | | | | | | | | | | | | | | | | | | | | | |
| | | I.R. | More than 10,000MΩ or 100MΩ • μF (Whichever is smaller) | | | | | | | | | | | | | | | | | | | | | | | | | | | | |
| | | Dielectric Strength | In accordance with item No.4 | | | | | | | | | | | | | | | | | | | | | | | | | | | | |
| 15 | Humidity (Steady State) | Appearance | No marking defects | Let the capacitor sit at 40±2°C and relative humidity of 90 to 95% for 500±24hrs. Remove and let sit for 24±2 hrs. at room condition,* then measure. •Pretreatment Perform a heat treatment at 150±10°C for 60±5 min. and then let sit for 24±2 hrs. at room condition.* | | | | | | | | | | | | | | | | | | | | | | | | | | | |
| | | Capacitance Change | Within ±12.5% | | | | | | | | | | | | | | | | | | | | | | | | | | | | |
| | | D.F. | 0.02 max. | | | | | | | | | | | | | | | | | | | | | | | | | | | | |
| | | I.R. | More than 1,000MΩ or 10MΩ • μF (Whichever is smaller) | | | | | | | | | | | | | | | | | | | | | | | | | | | | |
| | | Dielectric Strength | In accordance with item No.4 | | | | | | | | | | | | | | | | | | | | | | | | | | | | |

* "Room condition" Temperature: 15 to 35°C, Relative humidity: 45 to 75%, Atmospheric pressure: 86 to 106kPa

Continued on the following page. ↗

For General Purpose GRM/GRU/GR3 Series

Only for Applications

AC250V Type GA2 Series

Safety Standard Certified GA3 Series

Product Information

GR3 Series Specifications and Test Methods

↳ Continued from the preceding page.

| No. | Item | Specifications | Test Method | | | | | | | | | |
|--------------------|---|------------------------------|---|---|------------------------------|-----------------|--------|---------------------------|--------|---------------------------|--------|---------------------------|
| 16 | Life | Appearance | No marking defects | Apply voltage as Table for 1,000 ^{±4} hrs. at maximum operating temperature ±3°C. Remove and let sit for 24±2hrs. at room condition,* then measure. <table border="1" style="margin: 5px auto; border-collapse: collapse;"> <thead> <tr style="background-color: #f2f2f2;"> <th style="font-size: small;">Rated Voltage</th> <th style="font-size: small;">Applied Voltage</th> </tr> </thead> <tbody> <tr> <td style="text-align: center;">DC250V</td> <td style="text-align: center;">150% of the rated voltage</td> </tr> <tr> <td style="text-align: center;">DC450V</td> <td style="text-align: center;">130% of the rated voltage</td> </tr> <tr> <td style="text-align: center;">DC630V</td> <td style="text-align: center;">120% of the rated voltage</td> </tr> </tbody> </table> | Rated Voltage | Applied Voltage | DC250V | 150% of the rated voltage | DC450V | 130% of the rated voltage | DC630V | 120% of the rated voltage |
| | | Rated Voltage | Applied Voltage | | | | | | | | | |
| | | DC250V | 150% of the rated voltage | | | | | | | | | |
| | | DC450V | 130% of the rated voltage | | | | | | | | | |
| | | DC630V | 120% of the rated voltage | | | | | | | | | |
| Capacitance Change | Within ±12.5% | | | | | | | | | | | |
| D.F. | 0.02 max. | | | | | | | | | | | |
| I.R. | More than 1,000MΩ or 10MΩ • μF (Whichever is smaller) | | | | | | | | | | | |
| | Dielectric Strength | In accordance with item No.4 | The charge/discharge current is less than 50mA. •Pretreatment Apply test voltage for 60±5 min. at test temperature. Remove and let sit for 24±2 hrs. at room condition.* | | | | | | | | | |
| 17 | Humidity Loading | Appearance | No marking defects | Apply the rated voltage at 40±2°C and relative humidity of 90 to 95% for 500 ^{±2} hrs. Remove and let sit for 24±2 hrs. at room condition,* then measure. •Pretreatment Apply test voltage for 60±5 min. at test temperature. Remove and let sit for 24±2 hrs. at room condition.* | | | | | | | | |
| | | Capacitance Change | Within ±12.5% | | | | | | | | | |
| | | D.F. | 0.02 max. | | | | | | | | | |
| | | I.R. | More than 1,000MΩ or 10MΩ • μF (Whichever is smaller) | | | | | | | | | |
| | | | Dielectric Strength | | In accordance with item No.4 | | | | | | | |

* "Room condition" Temperature: 15 to 35°C, Relative humidity: 45 to 75%, Atmospheric pressure: 86 to 106kPa

For General Purpose GRM/GRJ/GR3 Series

Only for Applications

AC250V Type GA2 Series

Safety Standard Certified GA3 Series

Product Information

Chip Monolithic Ceramic Capacitors (Medium Voltage)

For LCD Backlight Inverter Circuit GRM/DC3.15kV Series

■ Features

1. Low-loss and suitable for high frequency circuits
2. Murata's original internal electrode structure realizes high flash-over voltage.
3. A new monolithic structure for small, surface-mountable devices capable of operating at high voltage levels.
4. Sn-plated external electrodes realize good solderability.
5. Only for reflow soldering
6. Capacitance values less than 22pF can be used in LCD backlight inverter circuits as long as the applied voltage, peak to peak, is less than 4.0kV at 100kHz or less.

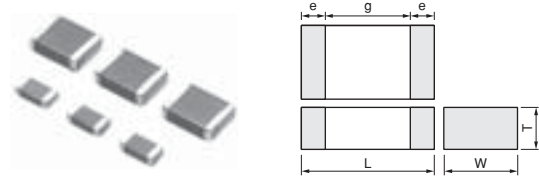

| Part Number | Dimensions (mm) | | | | |
|-------------|-----------------|----------|--------------|--------|--------|
| | L | W | T | e min. | g min. |
| GRM42A | 4.5 ±0.3 | 2.0 ±0.2 | 1.0 +0, -0.3 | 0.3 | 2.9 |

■ Applications

Ideal for use as the ballast in LCD backlight inverter.

Do not use these products in any Automotive Power train or Safety equipment including Battery chargers for Electric Vehicles and Plug-in Hybrids. Only Murata products clearly stipulated as "for Automotive use" can be used for automobile applications such as Power train and Safety equipment.

| Part Number | Rated Voltage | TC Code (Standard) | Capacitance | Length L (mm) | Width W (mm) | Thickness T max. (mm) | Electrode g min. | Electrode e |
|--------------------|---------------|--------------------|-------------|---------------|--------------|-----------------------|------------------|-------------|
| GRM42A5C3F050DW01L | 3150Vdc | C0G (EIA) | 5.0pF±0.5pF | 4.5 | 2.0 | 1 | 2.9mm | 0.3mm min. |
| GRM42A5C3F100JW01L | 3150Vdc | C0G (EIA) | 10pF±5% | 4.5 | 2.0 | 1 | 2.9mm | 0.3mm min. |
| GRM42A5C3F120JW01L | 3150Vdc | C0G (EIA) | 12pF±5% | 4.5 | 2.0 | 1 | 2.9mm | 0.3mm min. |
| GRM42A5C3F150JW01L | 3150Vdc | C0G (EIA) | 15pF±5% | 4.5 | 2.0 | 1 | 2.9mm | 0.3mm min. |
| GRM42A5C3F180JW01L | 3150Vdc | C0G (EIA) | 18pF±5% | 4.5 | 2.0 | 1 | 2.9mm | 0.3mm min. |
| GRM42A5C3F220JW01L | 3150Vdc | C0G (EIA) | 22pF±5% | 4.5 | 2.0 | 1 | 2.9mm | 0.3mm min. |
| GRM42A5C3F270JW01L | 3150Vdc | C0G (EIA) | 27pF±5% | 4.5 | 2.0 | 1 | 2.9mm | 0.3mm min. |
| GRM42A5C3F330JW01L | 3150Vdc | C0G (EIA) | 33pF±5% | 4.5 | 2.0 | 1 | 2.9mm | 0.3mm min. |
| GRM42A5C3F390JW01L | 3150Vdc | C0G (EIA) | 39pF±5% | 4.5 | 2.0 | 1 | 2.9mm | 0.3mm min. |
| GRM42A5C3F470JW01L | 3150Vdc | C0G (EIA) | 47pF±5% | 4.5 | 2.0 | 1 | 2.9mm | 0.3mm min. |

For General Purpose GRM/GRU/GR3 Series
 Only for Applications GRM/DC3.15kV Series
 AC250V Type GA2 Series
 Safety Standard Certified GA3 Series
 Product Information

GRM/DC3.15kV Series Specifications and Test Methods

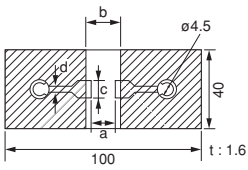
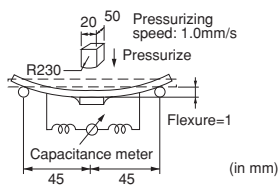
| No. | Item | Specifications | Test Method | | | | | | | | | | | | | | | |
|---|---|---|---|----------------|------------------|---|------|---|------------------------|---|------|---|------------------------|---------|------|-----|-----|-----|
| 1 | Operating Temperature Range | -55 to +125°C | - | | | | | | | | | | | | | | | |
| 2 | Appearance | No defects or abnormalities | Visual inspection | | | | | | | | | | | | | | | |
| 3 | Dimensions | Within the specified dimension | Using calipers and micrometers | | | | | | | | | | | | | | | |
| 4 | Dielectric Strength | No defects or abnormalities | No failure should be observed when DC4095V is applied between the terminations for 1 to 5 sec., provided the charge/discharge current is less than 50mA. | | | | | | | | | | | | | | | |
| 5 | Insulation Resistance (I.R.) | More than 10,000MΩ | The insulation resistance should be measured with DC500±50V and within 60±5 sec. of charging. | | | | | | | | | | | | | | | |
| 6 | Capacitance | Within the specified tolerance | The capacitance/Q should be measured at a frequency of 1±0.2MHz and a voltage of AC0.5 to 5V(r.m.s.). | | | | | | | | | | | | | | | |
| 7 | Q | 1,000 min. | | | | | | | | | | | | | | | | |
| 8 | Capacitance Temperature Characteristics | Temp. Coefficient 0±30ppm/°C (Temp. Range: +25 to +125°C) 0+30, -72ppm/°C (Temp. Range: -55 to +25°C) | The capacitance measurement should be made at each step specified in the Table. | | | | | | | | | | | | | | | |
| | | | <table border="1" style="width: 100%; border-collapse: collapse; text-align: center;"> <thead> <tr style="background-color: #f2f2f2;"> <th>Step</th> <th>Temperature (°C)</th> </tr> </thead> <tbody> <tr> <td>1</td> <td>25±2</td> </tr> <tr> <td>2</td> <td>Min. Operating Temp.±3</td> </tr> <tr> <td>3</td> <td>25±2</td> </tr> <tr> <td>4</td> <td>Max. Operating Temp.±2</td> </tr> <tr> <td>5</td> <td>25±2</td> </tr> </tbody> </table> | Step | Temperature (°C) | 1 | 25±2 | 2 | Min. Operating Temp.±3 | 3 | 25±2 | 4 | Max. Operating Temp.±2 | 5 | 25±2 | | | |
| Step | Temperature (°C) | | | | | | | | | | | | | | | | | |
| 1 | 25±2 | | | | | | | | | | | | | | | | | |
| 2 | Min. Operating Temp.±3 | | | | | | | | | | | | | | | | | |
| 3 | 25±2 | | | | | | | | | | | | | | | | | |
| 4 | Max. Operating Temp.±2 | | | | | | | | | | | | | | | | | |
| 5 | 25±2 | | | | | | | | | | | | | | | | | |
| 9 | Adhesive Strength of Termination | No removal of the terminations or other defect should occur. | Solder the capacitor to the testing jig (glass epoxy board) shown in Fig. 1. Then apply 10N force in the direction of the arrow. The soldering should be done using the reflow method and should be conducted with care so that the soldering is uniform and free of defects such as heat shock. | | | | | | | | | | | | | | | |
| 10 | Vibration Resistance | Appearance | No defects or abnormalities | | | | | | | | | | | | | | | |
| | | Capacitance | Within the specified tolerance | | | | | | | | | | | | | | | |
| | | Q | 1,000 min. | | | | | | | | | | | | | | | |
| 11 | Deflection | No marking defects | Solder the capacitor to the testing jig (glass epoxy board) shown in Fig. 2. Then apply a force in the direction shown in Fig. 3. The soldering should be done using the reflow method and should be conducted with care so that the soldering is uniform and free of defects such as heat shock. | | | | | | | | | | | | | | | |
| | |  <p style="text-align: center;">Fig. 2</p> <table border="1" style="width: 100%; border-collapse: collapse; text-align: center;"> <thead> <tr style="background-color: #f2f2f2;"> <th>L×W (mm)</th> <th colspan="4">Dimension (mm)</th> </tr> <tr style="background-color: #f2f2f2;"> <th></th> <th>a</th> <th>b</th> <th>c</th> <th>d</th> </tr> </thead> <tbody> <tr> <td>4.5×2.0</td> <td>3.5</td> <td>7.0</td> <td>2.4</td> <td>1.0</td> </tr> </tbody> </table> | | L×W (mm) | Dimension (mm) | | | | | a | b | c | d | 4.5×2.0 | 3.5 | 7.0 | 2.4 | 1.0 |
| | | L×W (mm) | | Dimension (mm) | | | | | | | | | | | | | | |
| | a | b | c | d | | | | | | | | | | | | | | |
| 4.5×2.0 | 3.5 | 7.0 | 2.4 | 1.0 | | | | | | | | | | | | | | |
|  <p style="text-align: center;">Fig. 3</p> | | | | | | | | | | | | | | | | | | |

Continued on the following page. ↗

For General Purpose GRM/GRJ/GR3 Series

Only for Applications GRM/DC3.15kV Series

AC250V Type GA2 Series

Safety Standard Certified GA3 Series

Product Information

GRM/DC3.15kV Series Specifications and Test Methods

Continued from the preceding page.

| No. | Item | Specifications | Test Method |
|-----|------------------------------|---|---|
| 12 | Solderability of Termination | 75% of the terminations are to be soldered evenly and continuously. | Immerse the capacitor in a solution of ethanol (JIS-K-8101) and rosin (JIS-K-5902) (25% rosin in weight proportion). Immerse in solder solution for 2±0.5 sec. Immersing speed: 25±2.5mm/s Temp. of solder: 245±5°C Lead Free Solder (Sn-3.0Ag-0.5Cu) 235±5°C H60A or H63A Eutectic Solder |
| 13 | Resistance to Soldering Heat | Appearance | No marking defects |
| | | Capacitance Change | Within ±2.5% |
| | | Q | 1,000 min. |
| | | I.R. | More than 10,000MΩ |
| 14 | Temperature Cycle | Appearance | No marking defects |
| | | Capacitance Change | Within ±2.5% |
| | | Q | 1,000 min. |
| | | I.R. | More than 10,000MΩ |
| 15 | Humidity (Steady State) | Appearance | No marking defects |
| | | Capacitance Change | Within ±5.0% |
| | | Q | 350 min. |
| | | I.R. | More than 1,000MΩ |
| 16 | Life | Appearance | No marking defects |
| | | Capacitance Change | Within ±3.0% |
| | | Q | 350 min. |
| | | I.R. | More than 1,000MΩ |
| 17 | Dielectric Strength | Appearance | No marking defects |
| | | Capacitance Change | Within ±2.5% |
| | | Q | 1,000 min. |
| | | I.R. | More than 10,000MΩ |

***Preheating**

| Step | Temperature | Time |
|------|--------------|--------|
| 1 | 100 to 120°C | 1 min. |
| 2 | 170 to 200°C | 1 min. |

Fix the capacitor to the supporting jig (glass epoxy board) shown in Fig. 4.
 Perform the 5 cycles according to the 4 heat treatments listed in the following table.
 Let sit for 24±2 hrs. at room condition,* then measure.

| Step | Temperature (°C) | Time (min.) |
|------|------------------------|-------------|
| 1 | Min. Operating Temp.±3 | 30±3 |
| 2 | Room Temp. | 2 to 3 |
| 3 | Max. Operating Temp.±2 | 30±3 |
| 4 | Room Temp. | 2 to 3 |

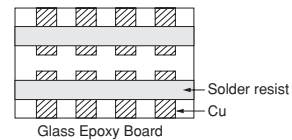

Fig. 4

* "Room condition" Temperature: 15 to 35°C, Relative humidity: 45 to 75%, Atmospheric pressure: 86 to 106kPa

For General Purpose GRM/GRU/GR3 Series
 Only for Applications GRM/DC3.15kV Series
 AC250V Type GA2 Series
 Safety Standard Certified GA3 Series
 Product Information

Chip Monolithic Ceramic Capacitors (Medium Voltage)

For Information Devices GR4 Series

■ Features

1. These items are designed specifically for telecommunications devices (IEEE802.3) in Ethernet LAN and primary-secondary coupling for DC-DC converters.
2. A new monolithic structure for small, high capacitance capable of operating at high voltage levels
3. Sn-plated external electrodes realize good solderability.
4. Only for reflow soldering

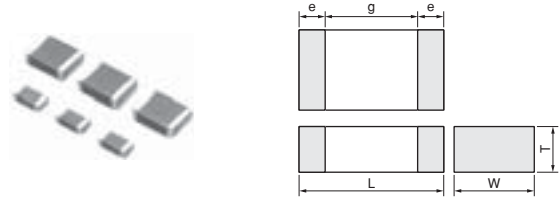

| Part Number | Dimensions (mm) | | | | |
|-------------|-----------------|----------|--------------|--------|--------|
| | L | W | T | e min. | g min. |
| GR442Q | 4.5 ±0.3 | 2.0 ±0.2 | 1.5 +0, -0.3 | 0.3 | 2.5 |
| GR443D | 4.5 ±0.4 | 3.2 ±0.3 | 2.0 +0, -0.3 | | |
| GR443Q | | | 1.5 +0, -0.3 | | |
| GR455D | 5.7 ±0.4 | 5.0 ±0.4 | 2.0 +0, -0.3 | | 3.2 |

■ Applications

1. Ideal for use on telecommunications devices in Ethernet LAN
2. Ideal for use as primary-secondary coupling for DC-DC converters

Do not use these products in any Automotive Power train or Safety equipment including Battery charger for Electric Vehicles and Plug-in Hybrid. Only Murata products clearly stipulated as "for Automotive use" can be used for automobile applications such as Power train and Safety equipment.

| Part Number | Rated Voltage | TC Code (Standard) | Capacitance | Length L (mm) | Width W (mm) | Thickness T max. (mm) | Electrode g min. | Electrode e |
|--------------------|---------------|--------------------|-------------|---------------|--------------|-----------------------|------------------|-------------|
| GR442QR73D101KW01L | 2000Vdc | X7R (EIA) | 100pF±10% | 4.5 | 2 | 1.5 | 2.5mm | 0.3mm min. |
| GR442QR73D121KW01L | 2000Vdc | X7R (EIA) | 120pF±10% | 4.5 | 2 | 1.5 | 2.5mm | 0.3mm min. |
| GR442QR73D151KW01L | 2000Vdc | X7R (EIA) | 150pF±10% | 4.5 | 2 | 1.5 | 2.5mm | 0.3mm min. |
| GR442QR73D181KW01L | 2000Vdc | X7R (EIA) | 180pF±10% | 4.5 | 2 | 1.5 | 2.5mm | 0.3mm min. |
| GR442QR73D221KW01L | 2000Vdc | X7R (EIA) | 220pF±10% | 4.5 | 2 | 1.5 | 2.5mm | 0.3mm min. |
| GR442QR73D271KW01L | 2000Vdc | X7R (EIA) | 270pF±10% | 4.5 | 2 | 1.5 | 2.5mm | 0.3mm min. |
| GR442QR73D331KW01L | 2000Vdc | X7R (EIA) | 330pF±10% | 4.5 | 2 | 1.5 | 2.5mm | 0.3mm min. |
| GR442QR73D391KW01L | 2000Vdc | X7R (EIA) | 390pF±10% | 4.5 | 2 | 1.5 | 2.5mm | 0.3mm min. |
| GR442QR73D471KW01L | 2000Vdc | X7R (EIA) | 470pF±10% | 4.5 | 2 | 1.5 | 2.5mm | 0.3mm min. |
| GR442QR73D561KW01L | 2000Vdc | X7R (EIA) | 560pF±10% | 4.5 | 2 | 1.5 | 2.5mm | 0.3mm min. |
| GR442QR73D681KW01L | 2000Vdc | X7R (EIA) | 680pF±10% | 4.5 | 2 | 1.5 | 2.5mm | 0.3mm min. |
| GR442QR73D821KW01L | 2000Vdc | X7R (EIA) | 820pF±10% | 4.5 | 2 | 1.5 | 2.5mm | 0.3mm min. |
| GR442QR73D102KW01L | 2000Vdc | X7R (EIA) | 1000pF±10% | 4.5 | 2 | 1.5 | 2.5mm | 0.3mm min. |
| GR442QR73D122KW01L | 2000Vdc | X7R (EIA) | 1200pF±10% | 4.5 | 2 | 1.5 | 2.5mm | 0.3mm min. |
| GR442QR73D152KW01L | 2000Vdc | X7R (EIA) | 1500pF±10% | 4.5 | 2 | 1.5 | 2.5mm | 0.3mm min. |
| GR443QR73D182KW01L | 2000Vdc | X7R (EIA) | 1800pF±10% | 4.5 | 3.2 | 1.5 | 2.5mm | 0.3mm min. |
| GR443QR73D222KW01L | 2000Vdc | X7R (EIA) | 2200pF±10% | 4.5 | 3.2 | 1.5 | 2.5mm | 0.3mm min. |
| GR443QR73D272KW01L | 2000Vdc | X7R (EIA) | 2700pF±10% | 4.5 | 3.2 | 1.5 | 2.5mm | 0.3mm min. |
| GR443QR73D332KW01L | 2000Vdc | X7R (EIA) | 3300pF±10% | 4.5 | 3.2 | 1.5 | 2.5mm | 0.3mm min. |
| GR443QR73D392KW01L | 2000Vdc | X7R (EIA) | 3900pF±10% | 4.5 | 3.2 | 1.5 | 2.5mm | 0.3mm min. |
| GR443DR73D472KW01L | 2000Vdc | X7R (EIA) | 4700pF±10% | 4.5 | 3.2 | 2 | 2.5mm | 0.3mm min. |
| GR455DR73D103KW01L | 2000Vdc | X7R (EIA) | 10000pF±10% | 5.7 | 5 | 2 | 3.2mm | 0.3mm min. |

For General Purpose GRW/GRJ/GR3 Series

Only for Applications GR4 Series

AC250V Type GA2 Series

Safety Standard Certified GA3 Series

Product Information

GR4 Series Specifications and Test Methods

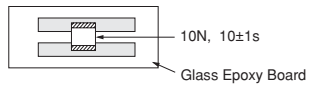
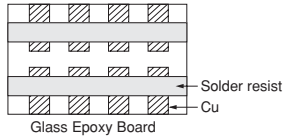
| No. | Item | Specifications | Test Method | | | | | | | | | |
|---------------|---|--|---|---------------|------------------|------|-------|---------------------------|------------------------|-----------------|-----------|---|
| 1 | Operating Temperature Range | -55 to +125°C | - | | | | | | | | | |
| 2 | Appearance | No defects or abnormalities | Visual inspection | | | | | | | | | |
| 3 | Dimensions | Within the specified dimensions | Using calipers and micrometers | | | | | | | | | |
| 4 | Dielectric Strength | No defects or abnormalities | No failure should be observed when voltage in the table is applied between the terminations, provided the charge/discharge current is less than 50mA. | | | | | | | | | |
| | | | <table border="1"> <thead> <tr> <th>Rated Voltage</th> <th>Test Voltage</th> <th>Time</th> </tr> </thead> <tbody> <tr> <td rowspan="2">DC2kV</td> <td>120% of the rated voltage</td> <td>60±1 sec.</td> </tr> <tr> <td>AC1500V(r.m.s.)</td> <td>60±1 sec.</td> </tr> </tbody> </table> | Rated Voltage | Test Voltage | Time | DC2kV | 120% of the rated voltage | 60±1 sec. | AC1500V(r.m.s.) | 60±1 sec. | |
| Rated Voltage | Test Voltage | Time | | | | | | | | | | |
| DC2kV | 120% of the rated voltage | 60±1 sec. | | | | | | | | | | |
| | AC1500V(r.m.s.) | 60±1 sec. | | | | | | | | | | |
| 5 | Pulse Voltage | No self healing breakdowns or flash-overs have taken place in the capacitor. | 10 impulses of alternating polarity are subjected. (5 impulses for each polarity) The interval between impulses is 60 sec. Applied Pulse: 1.2/50µs Applied Voltage: 2.5kVo-p | | | | | | | | | |
| 6 | Insulation Resistance (I.R.) | More than 6,000MΩ | The insulation resistance should be measured with DC500±50V and within 60±5 sec. of charging. | | | | | | | | | |
| 7 | Capacitance | Within the specified tolerance | The capacitance/D.F. should be measured at a frequency of 1±0.2kHz and a voltage of AC1±0.2V(r.m.s.). | | | | | | | | | |
| 8 | Dissipation Factor (D.F.) | 0.025 max. | | | | | | | | | | |
| 9 | Capacitance Temperature Characteristics | Cap. Change within ±15% (Temp. Range: -55 to +125°C) | The capacitance measurement should be made at each step specified in the Table. | | | | | | | | | |
| | | | <table border="1"> <thead> <tr> <th>Step</th> <th>Temperature (°C)</th> </tr> </thead> <tbody> <tr> <td>1</td> <td>25±2</td> </tr> <tr> <td>2</td> <td>Min. Operating Temp.±3</td> </tr> <tr> <td>3</td> <td>25±2</td> </tr> <tr> <td>4</td> <td>Max. Operating Temp.±2</td> </tr> <tr> <td>5</td> <td>25±2</td> </tr> </tbody> </table> | Step | Temperature (°C) | 1 | 25±2 | 2 | Min. Operating Temp.±3 | 3 | 25±2 | 4 |
| Step | Temperature (°C) | | | | | | | | | | | |
| 1 | 25±2 | | | | | | | | | | | |
| 2 | Min. Operating Temp.±3 | | | | | | | | | | | |
| 3 | 25±2 | | | | | | | | | | | |
| 4 | Max. Operating Temp.±2 | | | | | | | | | | | |
| 5 | 25±2 | | | | | | | | | | | |
| | | | •Pretreatment Perform a heat treatment at 150±9°C for 60±5 min. and then let sit for 24±2 hrs. at room condition.* | | | | | | | | | |
| 10 | Adhesive Strength of Termination | No removal of the terminations or other defect should occur. | Solder the capacitor to the testing jig (glass epoxy board) shown in Fig. 1. Then apply 10N force in the direction of the arrow. The soldering should be done using the reflow method and should be conducted with care so that the soldering is uniform and free of defects such as heat shock. | | | | | | | | | |
| | | |  <p style="text-align: center;">Fig. 1</p> | | | | | | | | | |
| 11 | Vibration Resistance | Appearance | No defects or abnormalities | | | | | | | | | |
| | | Capacitance | Within the specified tolerance | | | | | | | | | |
| | | D.F. | 0.025 max. | | | | | | | | | |
| | | | Solder the capacitor to the test jig (glass epoxy board). The capacitor should be subjected to a simple harmonic motion having a total amplitude of 1.5mm, the frequency being varied uniformly between the approximate limits of 10 and 55Hz. The frequency range, from 10 to 55Hz and return to 10Hz, should be traversed in approximately 1 min. This motion should be applied for a period of 2 hrs. in each of 3 mutually perpendicular directions (total of 6 hrs.). | | | | | | | | | |
| | | |  | | | | | | | | | |

* "Room condition" Temperature: 15 to 35°C, Relative humidity: 45 to 75%, Atmospheric pressure: 86 to 106kPa

Continued on the following page. 

For General Purpose GRM/GRU/GR3 Series
 Only for Applications GR4 Series
 AC250V Type GA2 Series
 Safety Standard Certified GA3 Series
 Product Information

GR4 Series Specifications and Test Methods

Continued from the preceding page.

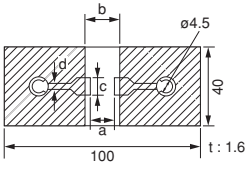
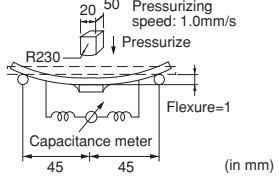
| No. | Item | Specifications | Test Method | | | | | | | | | | | | | | | | | | | |
|----------|------------------------------|--|---|----------|----------------|--|--|--|---|---|---|---|---------|-----|-----|-----|-----|---------|-----|-----|-----|---------|
| 12 | Deflection | No marking defects | Solder the capacitor to the testing jig (glass epoxy board) shown in Fig. 2. Then apply a force in the direction shown in Fig. 3. The soldering should be done using the reflow method and should be conducted with care so that the soldering is uniform and free of defects such as heat shock. | | | | | | | | | | | | | | | | | | | |
| | |  <p style="text-align: center;">Fig. 2</p> <table border="1" style="margin-left: auto; margin-right: auto;"> <thead> <tr> <th rowspan="2">L×W (mm)</th> <th colspan="4">Dimension (mm)</th> </tr> <tr> <th>a</th> <th>b</th> <th>c</th> <th>d</th> </tr> </thead> <tbody> <tr> <td>4.5×2.0</td> <td>3.5</td> <td>7.0</td> <td>2.4</td> <td rowspan="3" style="text-align: center;">1.0</td> </tr> <tr> <td>4.5×3.2</td> <td>3.5</td> <td>7.0</td> <td>3.7</td> </tr> <tr> <td>5.7×5.0</td> <td>4.5</td> <td>8.0</td> <td>5.6</td> </tr> </tbody> </table> | | L×W (mm) | Dimension (mm) | | | | a | b | c | d | 4.5×2.0 | 3.5 | 7.0 | 2.4 | 1.0 | 4.5×3.2 | 3.5 | 7.0 | 3.7 | 5.7×5.0 |
| L×W (mm) | Dimension (mm) | | | | | | | | | | | | | | | | | | | | | |
| | a | b | c | d | | | | | | | | | | | | | | | | | | |
| 4.5×2.0 | 3.5 | 7.0 | 2.4 | 1.0 | | | | | | | | | | | | | | | | | | |
| 4.5×3.2 | 3.5 | 7.0 | 3.7 | | | | | | | | | | | | | | | | | | | |
| 5.7×5.0 | 4.5 | 8.0 | 5.6 | | | | | | | | | | | | | | | | | | | |
| | | |  <p style="text-align: center;">Fig. 3</p> | | | | | | | | | | | | | | | | | | | |
| 13 | Solderability of Termination | 75% of the terminations are to be soldered evenly and continuously. | Immerse the capacitor in a solution of ethanol (JIS-K-8101) and rosin (JIS-K-5902) (25% rosin in weight proportion). Immerse in solder solution for 2±0.5 sec. Immersing speed: 25±2.5mm/s Temp. of solder: 245±5°C Lead Free Solder (Sn-3.0Ag-0.5Cu) 235±5°C H60A or H63A Eutectic Solder | | | | | | | | | | | | | | | | | | | |
| 14 | Resistance to Soldering Heat | Appearance | No marking defects | | | | | | | | | | | | | | | | | | | |
| | | Capacitance Change | Within ±10% | | | | | | | | | | | | | | | | | | | |
| | | D.F. | 0.025 max. | | | | | | | | | | | | | | | | | | | |
| | | I.R. | More than 1,000MΩ | | | | | | | | | | | | | | | | | | | |
| | | Dielectric Strength | In accordance with item No.4 | | | | | | | | | | | | | | | | | | | |
| 15 | Temperature Cycle | Appearance | No marking defects | | | | | | | | | | | | | | | | | | | |
| | | Capacitance Change | Within ±15% | | | | | | | | | | | | | | | | | | | |
| | | D.F. | 0.05 max. | | | | | | | | | | | | | | | | | | | |
| | | I.R. | More than 3,000MΩ | | | | | | | | | | | | | | | | | | | |
| | | Dielectric Strength | In accordance with item No.4 | | | | | | | | | | | | | | | | | | | |
| 16 | Humidity (Steady State) | Appearance | No marking defects | | | | | | | | | | | | | | | | | | | |
| | | Capacitance Change | Within ±15% | | | | | | | | | | | | | | | | | | | |
| | | D.F. | 0.05 max. | | | | | | | | | | | | | | | | | | | |
| | | I.R. | More than 1,000MΩ | | | | | | | | | | | | | | | | | | | |
| | | Dielectric Strength | In accordance with item No.4 | | | | | | | | | | | | | | | | | | | |

Preheat the capacitor as in table.
 Immerse the capacitor in solder solution at 260±5°C for 10±1 sec. Let sit at room condition* for 24±2 hrs., then measure.
 •Immersing speed: 25±2.5mm/s
 •Pretreatment
 Perform a heat treatment at 150±10°C for 60±5 min. and then let sit for 24±2 hrs. at room condition.*

*Preheating

| Step | Temperature | Time |
|------|--------------|--------|
| 1 | 100 to 120°C | 1 min. |
| 2 | 170 to 200°C | 1 min. |

Let sit for 24±2 hrs. at room condition,* then measure.

| Step | Temperature (°C) | Time (min.) |
|------|------------------------|-------------|
| 1 | Min. Operating Temp.±3 | 30±3 |
| 2 | Room Temp. | 2 to 3 |
| 3 | Max. Operating Temp.±2 | 30±3 |
| 4 | Room Temp. | 2 to 3 |

•Pretreatment
 Perform a heat treatment at 150±10°C for 60±5 min. and then let sit for 24±2 hrs. at room condition.*

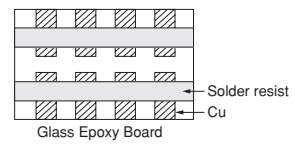

Let the capacitor sit at 40±2°C and relative humidity of 90 to 95% for 500±20 hrs.
 Remove and let sit for 24±2 hrs. at room condition,* then measure.

•Pretreatment
 Perform a heat treatment at 150±10°C for 60±5 min. and then let sit for 24±2 hrs. at room condition.*

* "Room condition" Temperature: 15 to 35°C, Relative humidity: 45 to 75%, Atmospheric pressure: 86 to 106kPa

Continued on the following page. ↗

For General Purpose GRM/GRJ/GR4 Series

Only for Applications GR4 Series

AC250V Type GA2 Series

Safety Standard Certified GA3 Series

Product Information

GR4 Series Specifications and Test Methods

↳ Continued from the preceding page.

| No. | Item | Specifications | Test Method |
|-----|------|------------------------------|--|
| 17 | Life | Appearance | Apply 110% of the rated voltage for $1,000 \pm 48$ hrs. at maximum operating temperature $\pm 3^\circ\text{C}$. Remove and let sit for 24 ± 2 hrs. at room condition,* then measure. The charge/discharge current is less than 50mA. •Pretreatment Apply test voltage for 60 ± 5 min. at test temperature. Remove and let sit for 24 ± 2 hrs. at room condition.* |
| | | Capacitance Change | |
| | | D.F. | |
| | | I.R. | |
| | | Dielectric Strength | |
| | | No marking defects | |
| | | Within $\pm 20\%$ | |
| | | 0.05 max. | |
| | | More than 2,000M Ω | |
| | | In accordance with item No.4 | |

* "Room condition" Temperature: 15 to 35°C, Relative humidity: 45 to 75%, Atmospheric pressure: 86 to 106kPa

For General Purpose
GRM/GRJ/GR3 Series

Only for Applications
GR4 Series

AC250V Type
GA2 Series

Safety Standard
Certified GA3 Series

Product Information

Chip Monolithic Ceramic Capacitors (Medium Voltage)

For Camera Flash Circuit GR7 Series

■ Features

1. Suitable for the trigger of the flash circuit, because real capacitance is stable during operating voltage.
2. The thin type fits thinner cameras.
3. Sn-plated external electrodes realize good solderability.
4. For flow and reflow soldering

■ Applications

For strobe circuit

Do not use these products in any Automotive Power train or Safety equipment including Battery chargers for Electric Vehicles and Plug-in Hybrids. Only Murata products clearly stipulated as "for Automotive use" can be used for automobile applications such as Power train and Safety equipment.

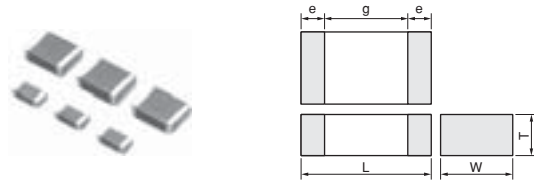

| Part Number | Dimensions (mm) | | | | |
|-------------|-----------------|-----------|---------------|--------|--------|
| | L | W | T | e min. | g min. |
| GR721A | 2.0 ±0.2 | 1.25 ±0.2 | 1.0 +0, -0.3 | 0.3 | 0.7 |
| GR721B | | | 1.25 ±0.2 | | |
| GR731A | 3.2 ±0.2 | 1.6 ±0.2 | 1.0 +0, -0.3 | | 1.2 |
| GR731B | | | 1.25 +0, -0.3 | | |
| GR731C | | | 1.6 ±0.2 | | |

| Part Number | Rated Voltage | TC Code (Standard) | Capacitance | Length L (mm) | Width W (mm) | Thickness T max. (mm) | Electrode g min. | Electrode e |
|--------------------|---------------|--------------------|-------------|---------------|--------------|-----------------------|------------------|-------------|
| GR721AW0BB103KW01D | 350Vdc | - | 10000pF±10% | 2 | 1.25 | 1 | 0.7mm | 0.3mm min. |
| GR731AW0BB103KW01D | 350Vdc | - | 10000pF±10% | 3.2 | 1.6 | 1 | 1.2mm | 0.3mm min. |
| GR721AW0BB153KW01D | 350Vdc | - | 15000pF±10% | 2 | 1.25 | 1 | 0.7mm | 0.3mm min. |
| GR731AW0BB153KW01D | 350Vdc | - | 15000pF±10% | 3.2 | 1.6 | 1 | 1.2mm | 0.3mm min. |
| GR721BW0BB223KW03L | 350Vdc | - | 22000pF±10% | 2 | 1.25 | 1.45 | 0.7mm | 0.3mm min. |
| GR731AW0BB223KW01D | 350Vdc | - | 22000pF±10% | 3.2 | 1.6 | 1 | 1.2mm | 0.3mm min. |
| GR731BW0BB223KW01L | 350Vdc | - | 22000pF±10% | 3.2 | 1.6 | 1.25 | 1.2mm | 0.3mm min. |
| GR721BW0BB273KW03L | 350Vdc | - | 27000pF±10% | 2 | 1.25 | 1.45 | 0.7mm | 0.3mm min. |
| GR731AW0BB273KW01D | 350Vdc | - | 27000pF±10% | 3.2 | 1.6 | 1 | 1.2mm | 0.3mm min. |
| GR731AW0BB333KW01D | 350Vdc | - | 33000pF±10% | 3.2 | 1.6 | 1 | 1.2mm | 0.3mm min. |
| GR731BW0BB333KW01L | 350Vdc | - | 33000pF±10% | 3.2 | 1.6 | 1.25 | 1.2mm | 0.3mm min. |
| GR731CW0BB473KW03L | 350Vdc | - | 47000pF±10% | 3.2 | 1.6 | 1.8 | 1.2mm | 0.3mm min. |

For General Purpose GRW/GRJ/GR3 Series

Only for Applications GR7 Series

AC250V Type GA2 Series

Safety Standard Certified GA3 Series

Product Information

GR7 Series Specifications and Test Methods

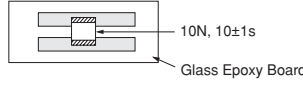
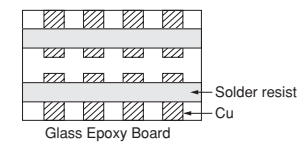
| No. | Item | Specifications | Test Method | | | | | | | | | |
|------|---|---|---|------|------------------|---|------------|---|------------------------------|---|------------|---|
| 1 | Operating Temperature Range | -55 to +125°C | - | | | | | | | | | |
| 2 | Appearance | No defects or abnormalities | Visual inspection | | | | | | | | | |
| 3 | Dimensions | Within the specified dimensions | Using calipers and micrometers | | | | | | | | | |
| 4 | Dielectric Strength | No defects or abnormalities | No failure should be observed when DC500V is applied between the terminations for 1 to 5 sec., provided the charge/discharge current is less than 50mA. | | | | | | | | | |
| 5 | Insulation Resistance (I.R.) | C \geq 0.01 μ F: More than 100M Ω \cdot μ F C<0.01 μ F: More than 10,000M Ω | The insulation resistance should be measured with DC250 \pm 50V and within 60 \pm 5 sec. of charging. | | | | | | | | | |
| 6 | Capacitance | Within the specified tolerance | The capacitance/D.F. should be measured at a frequency of 1 \pm 0.2kHz and a voltage of AC1 \pm 0.2V(r.m.s.). | | | | | | | | | |
| 7 | Dissipation Factor (D.F.) | 0.025 max. | | | | | | | | | | |
| 8 | Capacitance Temperature Characteristics | Cap. Change Within \pm 10% (Apply DC350V bias) Within \pm 33% (No DC bias) (Temp. Range : -55 to +125°C) | The capacitance measurement should be made at each step specified in the Table. | | | | | | | | | |
| | | | <table border="1"> <thead> <tr> <th>Step</th> <th>Temperature (°C)</th> </tr> </thead> <tbody> <tr> <td>1</td> <td>25\pm2</td> </tr> <tr> <td>2</td> <td>Min. Operating Temp.\pm3</td> </tr> <tr> <td>3</td> <td>25\pm2</td> </tr> <tr> <td>4</td> <td>Max. Operating Temp.\pm2</td> </tr> <tr> <td>5</td> <td>25\pm2</td> </tr> </tbody> </table> <p>•Pretreatment Perform a heat treatment at 150\pm5°C for 60\pm5 min. and then let sit for 24\pm2 hrs. at room condition.*</p> | Step | Temperature (°C) | 1 | 25 \pm 2 | 2 | Min. Operating Temp. \pm 3 | 3 | 25 \pm 2 | 4 |
| Step | Temperature (°C) | | | | | | | | | | | |
| 1 | 25 \pm 2 | | | | | | | | | | | |
| 2 | Min. Operating Temp. \pm 3 | | | | | | | | | | | |
| 3 | 25 \pm 2 | | | | | | | | | | | |
| 4 | Max. Operating Temp. \pm 2 | | | | | | | | | | | |
| 5 | 25 \pm 2 | | | | | | | | | | | |
| 9 | Adhesive Strength of Termination | No removal of the terminations or other defect should occur. | Solder the capacitor to the testing jig (glass epoxy board) shown in Fig. 1. Then apply 10N force in the direction of the arrow. The soldering should be done using the reflow method and should be conducted with care so that the soldering is uniform and free of defects such as heat shock. | | | | | | | | | |
| 10 | Vibration Resistance | Appearance | No defects or abnormalities | | | | | | | | | |
| | | Capacitance | Within the specified tolerance | | | | | | | | | |
| | | D.F. | 0.025 max. | | | | | | | | | |
| | | | Solder the capacitor to the test jig (glass epoxy board). The capacitor should be subjected to a simple harmonic motion having a total amplitude of 1.5mm, the frequency being varied uniformly between the approximate limits of 10 and 55Hz. The frequency range, from 10 to 55Hz and return to 10Hz, should be traversed in approximately 1 min. This motion should be applied for a period of 2 hrs. in each of 3 mutually perpendicular directions (total of 6 hrs.). | | | | | | | | | |
| | | |  <p>Fig. 1</p> | | | | | | | | | |
| | | |  | | | | | | | | | |

* "Room condition" Temperature: 15 to 35°C, Relative humidity: 45 to 75%, Atmospheric pressure: 86 to 106kPa

Continued on the following page. 

For General Purpose GRM/GRJ/GR3 Series
 Only for Applications GR7 Series
 AC250V Type GA2 Series
 Safety Standard Certified GA3 Series
 Product Information

GR7 Series Specifications and Test Methods

Continued from the preceding page.

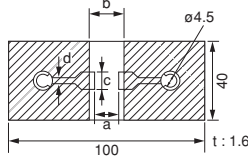
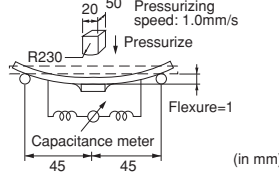
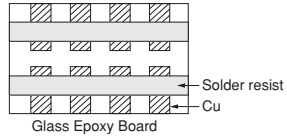
| No. | Item | Specifications | Test Method | | | | | | | | | | | | | | | | |
|----------|------------------------------|---|--|----------|------------------|-------------|---|------------------------|------|---|------------|--------|---|------------------------|------|-----|------------|--------|---------|
| 11 | Deflection | No marking defects | Solder the capacitor to the testing jig (glass epoxy board) shown in Fig. 2. Then apply a force in the direction shown in Fig. 3. The soldering should be done using the reflow method and should be conducted with care so that the soldering is uniform and free of defects such as heat shock. | | | | | | | | | | | | | | | | |
| | |  <p style="text-align: center;">Fig. 2</p> <table border="1" style="margin-left: auto; margin-right: auto;"> <thead> <tr> <th>L×W (mm)</th> <th colspan="4">Dimension (mm)</th> </tr> <tr> <th></th> <th>a</th> <th>b</th> <th>c</th> <th>d</th> </tr> </thead> <tbody> <tr> <td>2.0×1.25</td> <td>1.2</td> <td>4.0</td> <td>1.65</td> <td rowspan="2" style="text-align: center;">1.0</td> </tr> <tr> <td>3.2×1.6</td> <td>2.2</td> <td>5.0</td> <td>2.0</td> </tr> </tbody> </table> | | L×W (mm) | Dimension (mm) | | | | | a | b | c | d | 2.0×1.25 | 1.2 | 4.0 | 1.65 | 1.0 | 3.2×1.6 |
| L×W (mm) | Dimension (mm) | | | | | | | | | | | | | | | | | | |
| | a | b | c | d | | | | | | | | | | | | | | | |
| 2.0×1.25 | 1.2 | 4.0 | 1.65 | 1.0 | | | | | | | | | | | | | | | |
| 3.2×1.6 | 2.2 | 5.0 | 2.0 | | | | | | | | | | | | | | | | |
| | | |  <p style="text-align: center;">Fig. 3</p> | | | | | | | | | | | | | | | | |
| 12 | Solderability of Termination | 75% of the terminations are to be soldered evenly and continuously. | Immerse the capacitor in a solution of ethanol (JIS-K-8101) and rosin (JIS-K-5902) (25% rosin in weight proportion). Immerse in solder solution for 2±0.5 sec. Immersing speed: 25±2.5mm/s Temp. of solder: 245±5°C Lead Free Solder (Sn-3.0Ag-0.5Cu) 235±5°C H60A or H63A Eutectic Solder | | | | | | | | | | | | | | | | |
| 13 | Resistance to Soldering Heat | Appearance | No marking defects | | | | | | | | | | | | | | | | |
| | | Capacitance Change | Within ±10% | | | | | | | | | | | | | | | | |
| | | D.F. | 0.025 max. | | | | | | | | | | | | | | | | |
| | | I.R. | $C \geq 0.01\mu\text{F}$: More than $100\text{M}\Omega \cdot \mu\text{F}$ $C < 0.01\mu\text{F}$: More than 10,000MΩ | | | | | | | | | | | | | | | | |
| | Dielectric Strength | In accordance with item No.4 | Preheat the capacitor at 120 to 150°C for 1 min. Immerse the capacitor in solder solution at 260±5°C for 10±1 sec. Let sit at room condition* for 24±2 hrs., then measure. •Immersing speed: 25±2.5mm/s •Pretreatment Perform a heat treatment at 150±1°C for 60±5 min. and then let sit for 24±2 hrs. at room condition.* | | | | | | | | | | | | | | | | |
| 14 | Temperature Cycle | Appearance: No marking defects Capacitance Change: Within ±7.5% D.F.: 0.025 max. I.R.: $C \geq 0.01\mu\text{F}$: More than $100\text{M}\Omega \cdot \mu\text{F}$ $C < 0.01\mu\text{F}$: More than 10,000MΩ Dielectric Strength: In accordance with item No.4 | | | | | | | | | | | | | | | | | |
| | | Fix the capacitor to the supporting jig (glass epoxy board) shown in Fig. 4. Perform the 5 cycles according to the 4 heat treatments listed in the following table. Let sit for 24±2 hrs. at room condition,* then measure. | | | | | | | | | | | | | | | | | |
| | | <table border="1" style="margin-left: auto; margin-right: auto;"> <thead> <tr> <th>Step</th> <th>Temperature (°C)</th> <th>Time (min.)</th> </tr> </thead> <tbody> <tr> <td>1</td> <td>Min. Operating Temp.±3</td> <td>30±3</td> </tr> <tr> <td>2</td> <td>Room Temp.</td> <td>2 to 3</td> </tr> <tr> <td>3</td> <td>Max. Operating Temp.±2</td> <td>30±3</td> </tr> <tr> <td>4</td> <td>Room Temp.</td> <td>2 to 3</td> </tr> </tbody> </table> <p>•Pretreatment Perform a heat treatment at 150±1°C for 60±5 min. and then let sit for 24±2 hrs. at room condition.*</p> | | Step | Temperature (°C) | Time (min.) | 1 | Min. Operating Temp.±3 | 30±3 | 2 | Room Temp. | 2 to 3 | 3 | Max. Operating Temp.±2 | 30±3 | 4 | Room Temp. | 2 to 3 | |
| Step | Temperature (°C) | Time (min.) | | | | | | | | | | | | | | | | | |
| 1 | Min. Operating Temp.±3 | 30±3 | | | | | | | | | | | | | | | | | |
| 2 | Room Temp. | 2 to 3 | | | | | | | | | | | | | | | | | |
| 3 | Max. Operating Temp.±2 | 30±3 | | | | | | | | | | | | | | | | | |
| 4 | Room Temp. | 2 to 3 | | | | | | | | | | | | | | | | | |
| | |  <p style="text-align: center;">Fig. 4</p> | | | | | | | | | | | | | | | | | |
| 15 | Humidity (Steady State) | Appearance | No marking defects | | | | | | | | | | | | | | | | |
| | | Capacitance Change | Within ±15% | | | | | | | | | | | | | | | | |
| | | D.F. | 0.05 max. | | | | | | | | | | | | | | | | |
| | | I.R. | $C \geq 0.01\mu\text{F}$: More than $10\text{M}\Omega \cdot \mu\text{F}$ $C < 0.01\mu\text{F}$: More than 1,000MΩ | | | | | | | | | | | | | | | | |
| | | Dielectric Strength | In accordance with item No.4 | | | | | | | | | | | | | | | | |
| | | Let the capacitor sit at 40±2°C and relative humidity of 90 to 95% for 500±24 hrs. Remove and let sit for 24±2 hrs. at room condition,* then measure. •Pretreatment Perform a heat treatment at 150±1°C for 60±5 min. and then let sit for 24±2 hrs. at room condition.* | | | | | | | | | | | | | | | | | |

* "Room condition" Temperature: 15 to 35°C, Relative humidity: 45 to 75%, Atmospheric pressure: 86 to 106kPa

Continued on the following page.

For General Purpose GRM/GRJ/GR3 Series

Only for Applications GR7 Series

AC250V Type GA2 Series

Safety Standard Certified GA3 Series

Product Information

GR7 Series Specifications and Test Methods

Continued from the preceding page.

| No. | Item | Specifications | Test Method |
|-----|------------------|---------------------|---|
| 16 | Life | Appearance | No marking defects |
| | | Capacitance Change | Within $\pm 15\%$ |
| | | D.F. | 0.05 max. |
| | | I.R. | $C \geq 0.01\mu\text{F}$: More than $10\text{M}\Omega \cdot \mu\text{F}$ $C < 0.01\mu\text{F}$: More than $1,000\text{M}\Omega$ |
| | | Dielectric Strength | In accordance with item No.4 |
| | | | Apply DC350V for $1,000^{+48}$ hrs. at maximum operating temperature $\pm 3^\circ\text{C}$. Remove and let sit for 24 ± 2 hrs. at room condition,* then measure. The charge/discharge current is less than 50mA. •Pretreatment Apply test voltage for 60 ± 5 min. at test temperature. Remove and let sit for 24 ± 2 hrs. at room condition.* |
| 17 | Humidity Loading | Appearance | No marking defects |
| | | Capacitance Change | Within $\pm 15\%$ |
| | | D.F. | 0.05 max. |
| | | I.R. | $C \geq 0.01\mu\text{F}$: More than $10\text{M}\Omega \cdot \mu\text{F}$ $C < 0.01\mu\text{F}$: More than $1,000\text{M}\Omega$ |
| | | Dielectric Strength | In accordance with item No.4 |
| | | | Apply the rated voltage at $40 \pm 2^\circ\text{C}$ and relative humidity of 90 to 95% for 500^{+24} hrs. Remove and let sit for 24 ± 2 hrs. at room condition,* then measure. •Pretreatment Apply test voltage for 60 ± 5 min. at test temperature. Remove and let sit for 24 ± 2 hrs. at room condition.* |

* "Room condition" Temperature: 15 to 35°C , Relative humidity: 45 to 75%, Atmospheric pressure: 86 to 106kPa

For General Purpose
 GRM/GRJ/GR3 Series

Only for Applications
 GR7 Series

AC250V Type
 GA2 Series

Safety Standard
 Certified GA3 Series

Product Information

Chip Monolithic Ceramic Capacitors

AC250V Type (Which Meet Japanese Law) GA2 Series

■ Features

1. Chip monolithic ceramic capacitor for AC lines.
2. A new monolithic structure for small, high capacitance capable of operating at high voltage levels.
3. Sn-plated external electrodes realize good solderability.
4. Only for reflow soldering
5. Capacitance 0.01 to 0.1uF for connecting lines and 470 to 4700pF for connecting lines to earth.

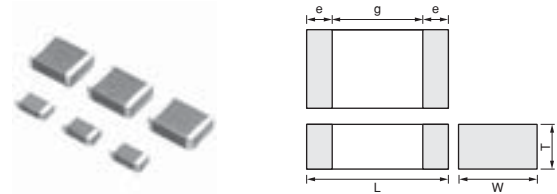

| Part Number | Dimensions (mm) | | | | |
|-------------|-----------------|----------|--------------|--------|--------|
| | L | W | T | e min. | g min. |
| GA242Q | 4.5 ±0.3 | 2.0 ±0.2 | 1.5 +0, -0.3 | 0.3 | 2.5 |
| GA243D | 4.5 ±0.4 | 3.2 ±0.3 | 2.0 +0, -0.3 | | |
| GA243Q | | | 1.5 +0, -0.3 | | |
| GA255D | 5.7 ±0.4 | 5.0 ±0.4 | 2.0 +0, -0.3 | | 3.2 |

■ Applications

Noise suppression filters for switching power supplies, telephones, facsimiles, modems.

Do not use these products in any Automotive Power train or Safety equipment including Battery chargers for Electric Vehicles and Plug-in Hybrids. Only Murata products clearly stipulated as "for Automotive use" can be used for automobile applications such as Power train and Safety equipment.

■ Reference Standard

GA2 series obtains no safety approval. This series is based on the standards of the electrical appliance and material safety law of Japan (separated table 4).

| Part Number | Rated Voltage | TC Code (Standard) | Capacitance | Length L (mm) | Width W (mm) | Thickness T max. (mm) | Electrode g min. | Electrode e |
|--------------------|----------------|--------------------|-------------|---------------|--------------|-----------------------|------------------|-------------|
| GA242QR7E2471MW01L | 250Vac(r.m.s.) | X7R (EIA) | 470pF±20% | 4.5 | 2.0 | 1.5 | 2.5mm | 0.3mm min. |
| GA242QR7E2102MW01L | 250Vac(r.m.s.) | X7R (EIA) | 1000pF±20% | 4.5 | 2.0 | 1.5 | 2.5mm | 0.3mm min. |
| GA243QR7E2222MW01L | 250Vac(r.m.s.) | X7R (EIA) | 2200pF±20% | 4.5 | 3.2 | 1.5 | 2.5mm | 0.3mm min. |
| GA243QR7E2332MW01L | 250Vac(r.m.s.) | X7R (EIA) | 3300pF±20% | 4.5 | 3.2 | 1.5 | 2.5mm | 0.3mm min. |
| GA243DR7E2472MW01L | 250Vac(r.m.s.) | X7R (EIA) | 4700pF±20% | 4.5 | 3.2 | 2 | 2.5mm | 0.3mm min. |
| GA243QR7E2103MW01L | 250Vac(r.m.s.) | X7R (EIA) | 1000pF±20% | 4.5 | 3.2 | 1.5 | 2.5mm | 0.3mm min. |
| GA243QR7E2223MW01L | 250Vac(r.m.s.) | X7R (EIA) | 2200pF±20% | 4.5 | 3.2 | 1.5 | 2.5mm | 0.3mm min. |
| GA243DR7E2473MW01L | 250Vac(r.m.s.) | X7R (EIA) | 4700pF±20% | 4.5 | 3.2 | 2 | 2.5mm | 0.3mm min. |
| GA255DR7E2104MW01L | 250Vac(r.m.s.) | X7R (EIA) | 0.10μF±20% | 5.7 | 5.0 | 2 | 3.2mm | 0.3mm min. |

For General Purpose GRM/GRJ/GR3 Series

Only for Applications

AC250V Type GA2 Series

Safety Standard Certified GA3 Series

Product Information

GA2 Series Specifications and Test Methods

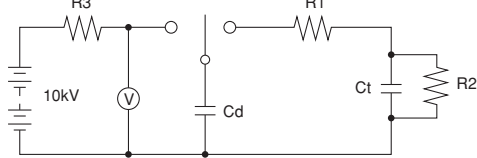
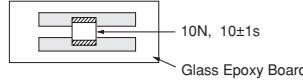
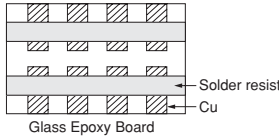
| No. | Item | Specifications | Test Method | | | | | | | | | | | | |
|---------------------|--|---|---|---------------------|------------------|------------|-----------------|------------|------------------------|---|------|---|------------------------|---|------|
| 1 | Operating Temperature Range | -55 to +125°C | - | | | | | | | | | | | | |
| 2 | Appearance | No defects or abnormalities | Visual inspection | | | | | | | | | | | | |
| 3 | Dimensions | Within the specified dimensions | Using calipers and micrometers | | | | | | | | | | | | |
| 4 | Dielectric Strength | No defects or abnormalities | No failure should be observed when voltage in the table is applied between the terminations for 60±1 sec., provided the charge/discharge current is less than 50mA. <table border="1"> <thead> <tr> <th>Nominal Capacitance</th> <th>Test Voltage</th> </tr> </thead> <tbody> <tr> <td>C≥10,000pF</td> <td>AC575V (r.m.s.)</td> </tr> <tr> <td>C<10,000pF</td> <td>AC1500V (r.m.s.)</td> </tr> </tbody> </table> | Nominal Capacitance | Test Voltage | C≥10,000pF | AC575V (r.m.s.) | C<10,000pF | AC1500V (r.m.s.) | | | | | | |
| Nominal Capacitance | Test Voltage | | | | | | | | | | | | | | |
| C≥10,000pF | AC575V (r.m.s.) | | | | | | | | | | | | | | |
| C<10,000pF | AC1500V (r.m.s.) | | | | | | | | | | | | | | |
| 5 | Insulation Resistance (I.R.) | More than 2,000MΩ | The insulation resistance should be measured with DC500±50V and within 60±5 sec. of charging. | | | | | | | | | | | | |
| 6 | Capacitance | Within the specified tolerance | The capacitance/D.F. should be measured at a frequency of 1±0.2kHz and a voltage of AC1±0.2V (r.m.s.). | | | | | | | | | | | | |
| 7 | Dissipation Factor (D.F.) | 0.025 max. | | | | | | | | | | | | | |
| 8 | Capacitance Temperature Characteristics | Cap. Change Within ±15% (Temp. Range: -55 to +125°C) | The capacitance measurement should be made at each step specified in the Table. <table border="1"> <thead> <tr> <th>Step</th> <th>Temperature (°C)</th> </tr> </thead> <tbody> <tr> <td>1</td> <td>25±2</td> </tr> <tr> <td>2</td> <td>Min. Operating Temp.±3</td> </tr> <tr> <td>3</td> <td>25±2</td> </tr> <tr> <td>4</td> <td>Max. Operating Temp.±2</td> </tr> <tr> <td>5</td> <td>25±2</td> </tr> </tbody> </table> <p>•Pretreatment Perform a heat treatment at 150±18°C for 60±5 min. and then let sit for 24±2 hrs. at room condition.*</p> | Step | Temperature (°C) | 1 | 25±2 | 2 | Min. Operating Temp.±3 | 3 | 25±2 | 4 | Max. Operating Temp.±2 | 5 | 25±2 |
| Step | Temperature (°C) | | | | | | | | | | | | | | |
| 1 | 25±2 | | | | | | | | | | | | | | |
| 2 | Min. Operating Temp.±3 | | | | | | | | | | | | | | |
| 3 | 25±2 | | | | | | | | | | | | | | |
| 4 | Max. Operating Temp.±2 | | | | | | | | | | | | | | |
| 5 | 25±2 | | | | | | | | | | | | | | |
| 9 | Discharge Test (Application: Nominal Capacitance C<10,000pF) | Appearance No defects or abnormalities | As in Fig., discharge is made 50 times at 5 sec. intervals from the capacitor (Cd) charged at DC voltage of specified.  Ct: Capacitor under test Cd: 0.001μF R1: 1,000Ω R2: 100MΩ R3: Surge resistance | | | | | | | | | | | | |
| 10 | Adhesive Strength of Termination | No removal of the terminations or other defects should occur. | Solder the capacitor to the testing jig (glass epoxy board) shown in Fig. 1. Then apply 10N force in the direction of the arrow. The soldering should be done using the reflow method and should be conducted with care so that the soldering is uniform and free of defects such as heat shock.  Fig. 1 | | | | | | | | | | | | |
| 11 | Vibration Resistance | Appearance | No defects or abnormalities | | | | | | | | | | | | |
| | | Capacitance | Within the specified tolerance | | | | | | | | | | | | |
| | | D.F. | 0.025 max. | | | | | | | | | | | | |
| | | | Solder the capacitor to the test jig (glass epoxy board). The capacitor should be subjected to a simple harmonic motion having a total amplitude of 1.5mm, the frequency being varied uniformly between the approximate limits of 10 and 55Hz. The frequency range, from 10 to 55Hz and return to 10Hz, should be traversed in approximately 1 min. This motion should be applied for a period of 2 hrs. in each of 3 mutually perpendicular directions (total of 6 hrs.).  | | | | | | | | | | | | |

* "Room condition" Temperature: 15 to 35°C, Relative humidity: 45 to 75%, Atmospheric pressure: 86 to 106kPa

Continued on the following page. 

For General Purpose GRM/GRU/GR3 Series
 Only for Applications AC250V Type GA2 Series
 Safety Standard Certified GA3 Series
 Product Information

GA2 Series Specifications and Test Methods

Continued from the preceding page.

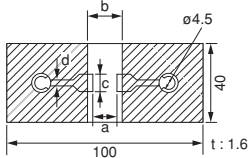
| No. | Item | Specifications | Test Method | | | | | | | | | | | | | | | | | | | |
|----------|------------------------------|--|--|----------|----------------|--|--|--|---|---|---|---|---------|-----|-----|-----|-----|---------|-----|-----|-----|---------|
| 12 | Deflection | No marking defects | Solder the capacitor to the testing jig (glass epoxy board) shown in Fig. 2. Then apply a force in the direction shown in Fig. 3. The soldering should be done using the reflow method and should be conducted with care so that the soldering is uniform and free of defects such as heat shock. | | | | | | | | | | | | | | | | | | | |
| | |  <p style="text-align: center;">Fig. 2</p> <table border="1" style="margin-left: auto; margin-right: auto;"> <thead> <tr> <th rowspan="2">L×W (mm)</th> <th colspan="4">Dimension (mm)</th> </tr> <tr> <th>a</th> <th>b</th> <th>c</th> <th>d</th> </tr> </thead> <tbody> <tr> <td>4.5×2.0</td> <td>3.5</td> <td>7.0</td> <td>2.4</td> <td rowspan="3" style="text-align: center;">1.0</td> </tr> <tr> <td>4.5×3.2</td> <td>3.5</td> <td>7.0</td> <td>3.7</td> </tr> <tr> <td>5.7×5.0</td> <td>4.5</td> <td>8.0</td> <td>5.6</td> </tr> </tbody> </table> | | L×W (mm) | Dimension (mm) | | | | a | b | c | d | 4.5×2.0 | 3.5 | 7.0 | 2.4 | 1.0 | 4.5×3.2 | 3.5 | 7.0 | 3.7 | 5.7×5.0 |
| L×W (mm) | Dimension (mm) | | | | | | | | | | | | | | | | | | | | | |
| | a | b | c | d | | | | | | | | | | | | | | | | | | |
| 4.5×2.0 | 3.5 | 7.0 | 2.4 | 1.0 | | | | | | | | | | | | | | | | | | |
| 4.5×3.2 | 3.5 | 7.0 | 3.7 | | | | | | | | | | | | | | | | | | | |
| 5.7×5.0 | 4.5 | 8.0 | 5.6 | | | | | | | | | | | | | | | | | | | |
| 13 | Solderability of Termination | 75% of the terminations are to be soldered evenly and continuously. | Immerse the capacitor in a solution of ethanol (JIS-K-8101) and rosin (JIS-K-5902) (25% rosin in weight proportion). Immerse in solder solution for 2±0.5 sec. Immersing speed: 25±2.5mm/s Temp. of solder: 245±5°C Lead Free Solder (Sn-3.0Ag-0.5Cu) 235±5°C H60A or H63A Eutectic Solder | | | | | | | | | | | | | | | | | | | |
| 14 | Humidity Insulation | Appearance | No marking defects | | | | | | | | | | | | | | | | | | | |
| | | Capacitance Change | Within ±15% | | | | | | | | | | | | | | | | | | | |
| | | D.F. | 0.05 max. | | | | | | | | | | | | | | | | | | | |
| | | I.R. | More than 1,000MΩ | | | | | | | | | | | | | | | | | | | |
| | | Dielectric Strength | In accordance with item No.4 | | | | | | | | | | | | | | | | | | | |
| 15 | Resistance to Soldering Heat | Appearance | No marking defects | | | | | | | | | | | | | | | | | | | |
| | | Capacitance Change | Within ±10% | | | | | | | | | | | | | | | | | | | |
| | | D.F. | 0.025 max. | | | | | | | | | | | | | | | | | | | |
| | | I.R. | More than 2,000MΩ | | | | | | | | | | | | | | | | | | | |
| | | Dielectric Strength | In accordance with item No.4 | | | | | | | | | | | | | | | | | | | |
| 16 | Temperature Cycle | Appearance | No marking defects | | | | | | | | | | | | | | | | | | | |
| | | Capacitance Change | Within ±15% | | | | | | | | | | | | | | | | | | | |
| | | D.F. | 0.05 max. | | | | | | | | | | | | | | | | | | | |
| | | I.R. | More than 2,000MΩ | | | | | | | | | | | | | | | | | | | |
| | | Dielectric Strength | In accordance with item No.4 | | | | | | | | | | | | | | | | | | | |

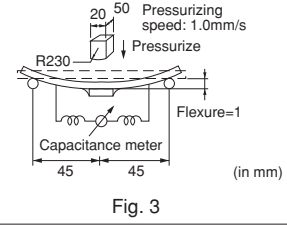

| Step | Temperature | Time |
|------|--------------|--------|
| 1 | 100 to 120°C | 1 min. |
| 2 | 170 to 200°C | 1 min. |

| Step | Temperature (°C) | Time (min.) |
|------|------------------------|-------------|
| 1 | Min. Operating Temp.±3 | 30±3 |
| 2 | Room Temp. | 2 to 3 |
| 3 | Max. Operating Temp.±2 | 30±3 |
| 4 | Room Temp. | 2 to 3 |

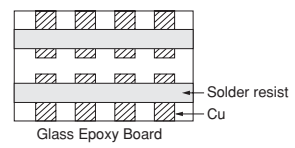

* "Room condition" Temperature: 15 to 35°C, Relative humidity: 45 to 75%, Atmospheric pressure: 86 to 106kPa

Continued on the following page. ↗

For General Purpose GRM/GRJ/GR3 Series

Only for Applications

AC250V Type GA2 Series

Safety Standard Certified GA3 Series

Product Information

GA2 Series Specifications and Test Methods

Continued from the preceding page.

| No. | Item | Specifications | Test Method | | | | | | | | | |
|---------------------|---|---------------------|---|---------------------|-----------|--------------|------------|---|-----------------|------------|---|------------------|
| 17 | Humidity (Steady State) | Appearance | No marking defects | | | | | | | | | |
| | | Capacitance Change | Within ±15% | | | | | | | | | |
| | | D.F. | 0.05 max. | | | | | | | | | |
| | | I.R. | More than 1,000MΩ | | | | | | | | | |
| | | Dielectric Strength | In accordance with item No.4 | | | | | | | | | |
| | | | Let the capacitor sit at 40±2°C and relative humidity of 90 to 95% for 500 ⁺²⁴ ₋₈ hrs. Remove and let sit for 24±2 hrs. at room condition,* then measure. •Pretreatment Perform a heat treatment at 150 [±] ₋₈ °C for 60±5 min. and then let sit for 24±2 hrs. at room condition.* | | | | | | | | | |
| 18 | Life | Appearance | No marking defects | | | | | | | | | |
| | | Capacitance Change | Within ±20% | | | | | | | | | |
| | | D.F. | 0.05 max. | | | | | | | | | |
| | | I.R. | More than 1,000MΩ | | | | | | | | | |
| | | Dielectric Strength | In accordance with item No.4 | | | | | | | | | |
| | | | Apply voltage and time as in Table at maximum operating temperature ±3°C. Remove and let sit for 24±2 hrs. at room condition,* then measure. The charge / discharge current is less than 50mA. <table border="1" style="margin-left: 20px;"> <thead> <tr> <th>Nominal Capacitance</th> <th>Test Time</th> <th>Test Voltage</th> </tr> </thead> <tbody> <tr> <td>C≥10,000pF</td> <td>1,000⁺⁴⁸₋₈ hrs.</td> <td>AC300V (r.m.s.)</td> </tr> <tr> <td>C<10,000pF</td> <td>1,500⁺⁴⁸₋₈ hrs.</td> <td>AC500V (r.m.s.)*</td> </tr> </tbody> </table> * Except that once each hour the voltage is increased to AC1,000V (r.m.s.) for 0.1 sec. •Pretreatment Apply test voltage for 60±5 min. at test temperature. Remove and let sit for 24±2 hrs. at room condition.* | Nominal Capacitance | Test Time | Test Voltage | C≥10,000pF | 1,000 ⁺⁴⁸ ₋₈ hrs. | AC300V (r.m.s.) | C<10,000pF | 1,500 ⁺⁴⁸ ₋₈ hrs. | AC500V (r.m.s.)* |
| Nominal Capacitance | Test Time | Test Voltage | | | | | | | | | | |
| C≥10,000pF | 1,000 ⁺⁴⁸ ₋₈ hrs. | AC300V (r.m.s.) | | | | | | | | | | |
| C<10,000pF | 1,500 ⁺⁴⁸ ₋₈ hrs. | AC500V (r.m.s.)* | | | | | | | | | | |
| 19 | Humidity Loading | Appearance | No marking defects | | | | | | | | | |
| | | Capacitance Change | Within ±15% | | | | | | | | | |
| | | D.F. | 0.05 max. | | | | | | | | | |
| | | I.R. | More than 1,000MΩ | | | | | | | | | |
| | | Dielectric Strength | In accordance with item No.4 | | | | | | | | | |
| | | | Apply the rated voltage at 40±2°C and relative humidity of 90 to 95% for 500 ⁺²⁴ ₋₈ hrs. Remove and let sit for 24±2 hrs. at room condition,* then measure. •Pretreatment Apply test voltage for 60±5 min. at test temperature. Remove and let sit for 24±2 hrs. at room condition.* | | | | | | | | | |

* "Room condition" Temperature: 15 to 35°C, Relative humidity: 45 to 75%, Atmospheric pressure: 86 to 106kPa

For General Purpose GRM/GRJ/GR3 Series

Only for Applications

AC250V Type GA2 Series

Safety Standard Certified GA3 Series

Product Information

Chip Monolithic Ceramic Capacitors

Safety Standard Certified GA3 Series UL, IEC60384-14 Class X1/Y2 Type GC

■ Features

1. Chip monolithic ceramic capacitor (certified as conforming to safety standards) for AC lines.
2. A new monolithic structure for small, high capacitance capable of operating at high voltage levels.
3. Compared to lead type capacitors, this new capacitor is greatly downsized and low-profiled to 1/10 or less in volume, and 1/4 or less in height.
4. Type GC can be used as an X1-class and Y2-class capacitor, line-by-pass capacitor of UL1414.
5. +125 degree C guaranteed
6. Only for reflow soldering

■ Applications

1. Ideal for use as Y capacitor or X capacitor for various switching power supplies
2. Ideal for modem applications

Do not use these products in any Automotive Power train or Safety equipment including Battery chargers for Electric Vehicles and Plug-in Hybrids. Only Murata products clearly stipulated as "for Automotive use" can be used for automobile applications such as Power train and Safety equipment.

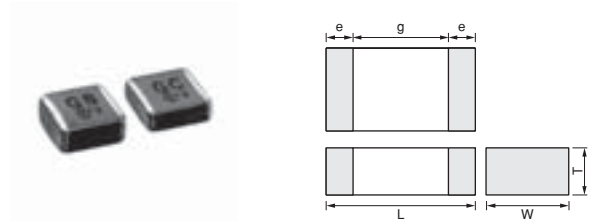

| Part Number | Dimensions (mm) | | | | |
|---------------|-----------------|----------|----------|--------|--------|
| | L | W | T | e min. | g min. |
| GA355D | 5.7 ±0.4 | 5.0 ±0.4 | 2.0 ±0.3 | 0.3 | 4.0 |

■ Standard Certification

| | Standard No. | Class | Rated Voltage |
|-------|--|--------------|--------------------|
| UL | UL1414 | Line By-pass | AC250V (r.m.s.) |
| VDE | IEC 60384-14 EN 60384-14 | X1, Y2 | |
| BSI | EN 60065 (14.2) IEC 60384-14 EN 60384-14 | | |
| SEMKO | IEC 60384-14 EN 60384-14 | | |
| ESTI | IEC 60384-14 | | |

| Part Number | Rated Voltage | TC Code (Standard) | Capacitance | Length L (mm) | Width W (mm) | Thickness T max. (mm) | Electrode g min. | Electrode e |
|---------------------------|----------------|--------------------|-------------|---------------|--------------|-----------------------|------------------|-------------|
| GA355DR7GC101KY02L | 250Vac(r.m.s.) | X7R (EIA) | 100pF±10% | 5.7 | 5.0 | 2.3 | 4.0mm | 0.3mm min. |
| GA355DR7GC151KY02L | 250Vac(r.m.s.) | X7R (EIA) | 150pF±10% | 5.7 | 5.0 | 2.3 | 4.0mm | 0.3mm min. |
| GA355DR7GC221KY02L | 250Vac(r.m.s.) | X7R (EIA) | 220pF±10% | 5.7 | 5.0 | 2.3 | 4.0mm | 0.3mm min. |
| GA355DR7GC331KY02L | 250Vac(r.m.s.) | X7R (EIA) | 330pF±10% | 5.7 | 5.0 | 2.3 | 4.0mm | 0.3mm min. |

For General Purpose
GRM/GRJ/GR3 Series

Only for Applications

AC250V Type
GA2 Series

Safety Standard
Certified GA3 Series

Product Information

Chip Monolithic Ceramic Capacitors

Safety Standard Certified GA3 Series IEC60384-14 Class Y2, X1/Y2 Type GF

■ Features

1. Available for equipment based on IEC/EN60950 and UL1950. Besides, the GA352/355 types are available for equipment based on IEC/EN60065, UL1492, and UL6500.
2. Type GF can be used as a Y2-class capacitor.
3. A new monolithic structure for small, high capacitance capable of operating at high voltage levels.
4. +125 degree C guaranteed
5. Only for reflow soldering

■ Applications

1. Ideal for use on line filters and couplings for DAA modems without transformers
2. Ideal for use on line filters for information equipment
3. Ideal for use as Y capacitor or X capacitor for various switching power supplies (GA352/355 types only)

Do not use these products in any Automotive Power train or Safety equipment including Battery chargers for Electric Vehicles and Plug-in Hybrids. Only Murata products clearly stipulated as "for Automotive use" can be used for automobile applications such as Power train and Safety equipment.

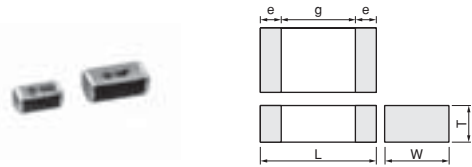

| Part Number | Dimensions (mm) | | | | |
|-------------|-----------------|----------|--------------|--------|--------|
| | L | W | T | e min. | g min. |
| GA342A | 4.5 ±0.3 | 2.0 ±0.2 | 1.0 +0, -0.3 | 0.3 | 2.5 |
| GA342D | | | 2.0 ±0.2 | | |
| GA342Q | | | 1.5 +0, -0.3 | | |
| GA352Q | 5.7 ±0.4 | 2.8 ±0.3 | 1.5 +0, -0.3 | | 4.0 |
| GA355D | | | 2.0 +0, -0.3 | | |
| GA355Q | | | 1.5 +0, -0.3 | | |

■ Standard Certification

| | Standard No. | Class | Status of Certification | | Rated Voltage |
|-------|--------------|--------|-------------------------|---------------------------|--------------------|
| | | | Size : 4.5x2.0mm | Size : 5.7x2.8mm and over | |
| UL | UL1414 | X1, Y2 | — | ⊙ | AC250V (r.m.s.) |
| | UL 60950-1 | — | ⊙ | — | |
| VDE | IEC 60384-14 | X1, Y2 | — | ⊙ | (r.m.s.) |
| SEMKO | EN 60384-14 | Y2 | ⊙ | ⊙ | |

Applications

| Size | Switching power supplies | Communication network devices such as a modem |
|--------------------|--------------------------|---|
| 4.5x2.0mm | — | ⊙ |
| 5.7x2.8mm and over | ⊙ | ⊙ |

| Part Number | Rated Voltage | TC Code (Standard) | Capacitance | Length L (mm) | Width W (mm) | Thickness T max. (mm) | Electrode g min. | Electrode e |
|--------------------|----------------|--------------------|-------------|---------------|--------------|-----------------------|------------------|-------------|
| GA342D1XGF100JY02L | 250Vac(r.m.s.) | SL (JIS) | 10pF±5% | 4.5 | 2.0 | 2.2 | 2.5mm | 0.3mm min. |
| GA342D1XGF120JY02L | 250Vac(r.m.s.) | SL (JIS) | 12pF±5% | 4.5 | 2.0 | 2.2 | 2.5mm | 0.3mm min. |
| GA342D1XGF150JY02L | 250Vac(r.m.s.) | SL (JIS) | 15pF±5% | 4.5 | 2.0 | 2.2 | 2.5mm | 0.3mm min. |
| GA342D1XGF180JY02L | 250Vac(r.m.s.) | SL (JIS) | 18pF±5% | 4.5 | 2.0 | 2.2 | 2.5mm | 0.3mm min. |
| GA342D1XGF220JY02L | 250Vac(r.m.s.) | SL (JIS) | 22pF±5% | 4.5 | 2.0 | 2.2 | 2.5mm | 0.3mm min. |
| GA342A1XGF270JW31L | 250Vac(r.m.s.) | SL (JIS) | 27pF±5% | 4.5 | 2.0 | 1 | 2.5mm | 0.3mm min. |
| GA342A1XGF330JW31L | 250Vac(r.m.s.) | SL (JIS) | 33pF±5% | 4.5 | 2.0 | 1 | 2.5mm | 0.3mm min. |
| GA342A1XGF390JW31L | 250Vac(r.m.s.) | SL (JIS) | 39pF±5% | 4.5 | 2.0 | 1 | 2.5mm | 0.3mm min. |
| GA342A1XGF470JW31L | 250Vac(r.m.s.) | SL (JIS) | 47pF±5% | 4.5 | 2.0 | 1 | 2.5mm | 0.3mm min. |
| GA342A1XGF560JW31L | 250Vac(r.m.s.) | SL (JIS) | 56pF±5% | 4.5 | 2.0 | 1 | 2.5mm | 0.3mm min. |
| GA342A1XGF680JW31L | 250Vac(r.m.s.) | SL (JIS) | 68pF±5% | 4.5 | 2.0 | 1 | 2.5mm | 0.3mm min. |
| GA342A1XGF820JW31L | 250Vac(r.m.s.) | SL (JIS) | 82pF±5% | 4.5 | 2.0 | 1 | 2.5mm | 0.3mm min. |
| GA342QR7GF101KW01L | 250Vac(r.m.s.) | X7R (EIA) | 100pF±10% | 4.5 | 2.0 | 1.5 | 2.5mm | 0.3mm min. |
| GA342QR7GF151KW01L | 250Vac(r.m.s.) | X7R (EIA) | 150pF±10% | 4.5 | 2.0 | 1.5 | 2.5mm | 0.3mm min. |
| GA342DR7GF221KW02L | 250Vac(r.m.s.) | X7R (EIA) | 220pF±10% | 4.5 | 2.0 | 2.2 | 2.5mm | 0.3mm min. |
| GA342DR7GF331KW02L | 250Vac(r.m.s.) | X7R (EIA) | 330pF±10% | 4.5 | 2.0 | 2.2 | 2.5mm | 0.3mm min. |
| GA342QR7GF471KW01L | 250Vac(r.m.s.) | X7R (EIA) | 470pF±10% | 4.5 | 2.0 | 1.5 | 2.5mm | 0.3mm min. |
| GA352QR7GF471KW01L | 250Vac(r.m.s.) | X7R (EIA) | 470pF±10% | 5.7 | 2.8 | 1.5 | 4.0mm | 0.3mm min. |
| GA342QR7GF681KW01L | 250Vac(r.m.s.) | X7R (EIA) | 680pF±10% | 4.5 | 2.0 | 1.5 | 2.5mm | 0.3mm min. |
| GA352QR7GF681KW01L | 250Vac(r.m.s.) | X7R (EIA) | 680pF±10% | 5.7 | 2.8 | 1.5 | 4.0mm | 0.3mm min. |
| GA342DR7GF102KW02L | 250Vac(r.m.s.) | X7R (EIA) | 1000pF±10% | 4.5 | 2.0 | 2.2 | 2.5mm | 0.3mm min. |
| GA352QR7GF102KW01L | 250Vac(r.m.s.) | X7R (EIA) | 1000pF±10% | 5.7 | 2.8 | 1.5 | 4.0mm | 0.3mm min. |

Continued on the following page. ↗

For General Purpose GRM/GRU/GR3 Series
 Only for Applications
 AC250V Type GA2 Series
 Safety Standard Certified GA3 Series
 Product Information

Continued from the preceding page.

| Part Number | Rated Voltage | TC Code (Standard) | Capacitance | Length L (mm) | Width W (mm) | Thickness T max. (mm) | Electrode g min. | Electrode e |
|---------------------------|----------------|--------------------|-------------|---------------|--------------|-----------------------|------------------|-------------|
| GA352QR7GF152KW01L | 250Vac(r.m.s.) | X7R (EIA) | 1500pF±10% | 5.7 | 2.8 | 1.5 | 4.0mm | 0.3mm min. |
| GA355QR7GF182KW01L | 250Vac(r.m.s.) | X7R (EIA) | 1800pF±10% | 5.7 | 5.0 | 1.5 | 4.0mm | 0.3mm min. |
| GA355QR7GF222KW01L | 250Vac(r.m.s.) | X7R (EIA) | 2200pF±10% | 5.7 | 5.0 | 1.5 | 4.0mm | 0.3mm min. |
| GA355QR7GF332KW01L | 250Vac(r.m.s.) | X7R (EIA) | 3300pF±10% | 5.7 | 5.0 | 1.5 | 4.0mm | 0.3mm min. |
| GA355DR7GF472KW01L | 250Vac(r.m.s.) | X7R (EIA) | 4700pF±10% | 5.7 | 5.0 | 2 | 4.0mm | 0.3mm min. |

For General Purpose
 GRW/GRJ/GR3 Series

Only for Applications

AC250V Type
 GA2 Series

Safety Standard
 Certified GA3 Series

Product Information

Chip Monolithic Ceramic Capacitors

Safety Standard Certified GA3 Series IEC60384-14 Class Y3 Type GD

■ Features

1. Available for equipment based on IEC/EN60950 and UL1950.
2. Type GD can be used as a Y3-class capacitor.
3. A new monolithic structure for small, high capacitance capable of operating at high voltage levels.
4. +125 degree C guaranteed
5. Only for reflow soldering

■ Applications

1. Ideal for use on line filters and couplings for DAA modems without transformers
2. Ideal for use on line filters for information equipment

Do not use these products in any Automotive Power train or Safety equipment including Battery chargers for Electric Vehicles and Plug-in Hybrids. Only Murata products clearly stipulated as "for Automotive use" can be used for automobile applications such as Power train and Safety equipment.

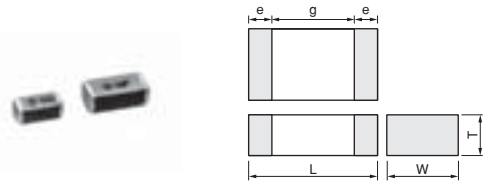

| Part Number | Dimensions (mm) | | | | |
|-------------|-----------------|----------|--------------|--------|--------|
| | L | W | T | e min. | g min. |
| GA342A | 4.5 ±0.3 | 2.0 ±0.2 | 1.0 +0, -0.3 | 0.3 | 2.5 |
| GA342D | | | 2.0 ±0.2 | | |
| GA342Q | | | 1.5 +0, -0.3 | | |
| GA343D | 4.5 ±0.4 | 3.2 ±0.3 | 2.0 +0, -0.3 | | |
| GA343Q | | | 1.5 +0, -0.3 | | |

■ Standard Certification

| | Standard No. | Class | Rated Voltage |
|-------|-----------------------------|-------|----------------|
| UL | UL 60950-1 | — | AC250V(r.m.s.) |
| SEMKO | IEC 60384-14 EN 60384-14 | Y3 | |

Applications

| Size | Switching power supplies | Communication network devices such as a modem |
|---------------------|--------------------------|---|
| 4.5x3.2mm and under | — | ◎ |

| Part Number | Rated Voltage | TC Code (Standard) | Capacitance | Length L (mm) | Width W (mm) | Thickness T max. (mm) | Electrode g min. | Electrode e |
|--------------------|----------------|--------------------|-------------|---------------|--------------|-----------------------|------------------|-------------|
| GA342D1XGD100JY02L | 250Vac(r.m.s.) | SL (JIS) | 10pF±5% | 4.5 | 2.0 | 2.2 | 2.5mm | 0.3mm min. |
| GA342D1XGD120JY02L | 250Vac(r.m.s.) | SL (JIS) | 12pF±5% | 4.5 | 2.0 | 2.2 | 2.5mm | 0.3mm min. |
| GA342D1XGD150JY02L | 250Vac(r.m.s.) | SL (JIS) | 15pF±5% | 4.5 | 2.0 | 2.2 | 2.5mm | 0.3mm min. |
| GA342D1XGD180JY02L | 250Vac(r.m.s.) | SL (JIS) | 18pF±5% | 4.5 | 2.0 | 2.2 | 2.5mm | 0.3mm min. |
| GA342D1XGD220JY02L | 250Vac(r.m.s.) | SL (JIS) | 22pF±5% | 4.5 | 2.0 | 2.2 | 2.5mm | 0.3mm min. |
| GA342A1XGD270JW31L | 250Vac(r.m.s.) | SL (JIS) | 27pF±5% | 4.5 | 2.0 | 1 | 2.5mm | 0.3mm min. |
| GA342A1XGD330JW31L | 250Vac(r.m.s.) | SL (JIS) | 33pF±5% | 4.5 | 2.0 | 1 | 2.5mm | 0.3mm min. |
| GA342A1XGD390JW31L | 250Vac(r.m.s.) | SL (JIS) | 39pF±5% | 4.5 | 2.0 | 1 | 2.5mm | 0.3mm min. |
| GA342A1XGD470JW31L | 250Vac(r.m.s.) | SL (JIS) | 47pF±5% | 4.5 | 2.0 | 1 | 2.5mm | 0.3mm min. |
| GA342A1XGD560JW31L | 250Vac(r.m.s.) | SL (JIS) | 56pF±5% | 4.5 | 2.0 | 1 | 2.5mm | 0.3mm min. |
| GA342A1XGD680JW31L | 250Vac(r.m.s.) | SL (JIS) | 68pF±5% | 4.5 | 2.0 | 1 | 2.5mm | 0.3mm min. |
| GA342A1XGD820JW31L | 250Vac(r.m.s.) | SL (JIS) | 82pF±5% | 4.5 | 2.0 | 1 | 2.5mm | 0.3mm min. |
| GA342QR7GD101KW01L | 250Vac(r.m.s.) | X7R (EIA) | 100pF±10% | 4.5 | 2.0 | 1.5 | 2.5mm | 0.3mm min. |
| GA342QR7GD151KW01L | 250Vac(r.m.s.) | X7R (EIA) | 150pF±10% | 4.5 | 2.0 | 1.5 | 2.5mm | 0.3mm min. |
| GA342QR7GD221KW01L | 250Vac(r.m.s.) | X7R (EIA) | 220pF±10% | 4.5 | 2.0 | 1.5 | 2.5mm | 0.3mm min. |
| GA342QR7GD331KW01L | 250Vac(r.m.s.) | X7R (EIA) | 330pF±10% | 4.5 | 2.0 | 1.5 | 2.5mm | 0.3mm min. |
| GA342QR7GD471KW01L | 250Vac(r.m.s.) | X7R (EIA) | 470pF±10% | 4.5 | 2.0 | 1.5 | 2.5mm | 0.3mm min. |
| GA342QR7GD681KW01L | 250Vac(r.m.s.) | X7R (EIA) | 680pF±10% | 4.5 | 2.0 | 1.5 | 2.5mm | 0.3mm min. |
| GA342QR7GD102KW01L | 250Vac(r.m.s.) | X7R (EIA) | 1000pF±10% | 4.5 | 2.0 | 1.5 | 2.5mm | 0.3mm min. |
| GA342QR7GD152KW01L | 250Vac(r.m.s.) | X7R (EIA) | 1500pF±10% | 4.5 | 2.0 | 1.5 | 2.5mm | 0.3mm min. |
| GA343QR7GD182KW01L | 250Vac(r.m.s.) | X7R (EIA) | 1800pF±10% | 4.5 | 3.2 | 1.5 | 2.5mm | 0.3mm min. |
| GA343QR7GD222KW01L | 250Vac(r.m.s.) | X7R (EIA) | 2200pF±10% | 4.5 | 3.2 | 1.5 | 2.5mm | 0.3mm min. |
| GA343DR7GD472KW01L | 250Vac(r.m.s.) | X7R (EIA) | 4700pF±10% | 4.5 | 3.2 | 2 | 2.5mm | 0.3mm min. |

For General Purpose GRM/GRU/GR3 Series
 Only for Applications
 AC250V Type GA2 Series
 Safety Standard Certified GA3 Series
 Product Information

Chip Monolithic Ceramic Capacitors

Safety Standard Certified GA3 Series IEC60384-14 Class X2 Type GB

■ Features

1. Type GB can be used as an X2-class capacitor.
2. Chip monolithic ceramic capacitor (certified as conforming to safety standards) for AC lines.
3. A new monolithic structure for small, high capacitance capable of operating at high voltage levels.
4. Compared to lead type capacitors, this new capacitor is greatly downsized and low-profiled to 1/10 or less in volume, and 1/4 or less in height.
5. +125 degree C guaranteed
6. Only for reflow soldering

■ Applications

Ideal for use as X capacitor for various switching power supplies

Do not use these products in any Automotive Power train or Safety equipment including Battery chargers for Electric Vehicles and Plug-in Hybrids. Only Murata products clearly stipulated as "for Automotive use" can be used for automobile applications such as Power train and Safety equipment.

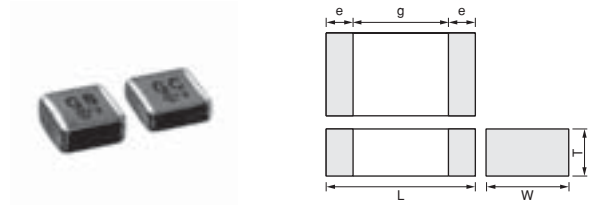

| Part Number | Dimensions (mm) | | | | |
|-------------|-----------------|----------|-------------|--------|--------|
| | L | W | T | e min. | g min. |
| GA355Q | 5.7 ±0.4 | 5.0 ±0.4 | 1.5 +0,-0.3 | 0.3 | 3.0 |
| GA355D | | | 2.0 +0,-0.3 | | |
| GA355E | | | 2.5 +0,-0.3 | | |
| GA355X | | | 2.9 +0,-0.4 | | |

■ Standard Certification

| | Standard No. | Class | Rated Voltage |
|-------|--------------|-------|-----------------|
| VDE | IEC 60384-14 | X2 | AC250V (r.m.s.) |
| SEMKO | EN 60384-14 | | |
| ESTI | IEC 60384-14 | | |

| Part Number | Rated Voltage | TC Code (Standard) | Capacitance | Length L (mm) | Width W (mm) | Thickness T max. (mm) | Electrode g min. | Electrode e |
|--------------------|----------------|--------------------|-------------|---------------|--------------|-----------------------|------------------|-------------|
| GA355QR7GB103KW01L | 250Vac(r.m.s.) | X7R (EIA) | 10000pF±10% | 5.7 | 5.0 | 1.5 | 3.0mm | 0.3mm min. |
| GA355QR7GB153KW01L | 250Vac(r.m.s.) | X7R (EIA) | 15000pF±10% | 5.7 | 5.0 | 1.5 | 3.0mm | 0.3mm min. |
| GA355DR7GB223KW01L | 250Vac(r.m.s.) | X7R (EIA) | 22000pF±10% | 5.7 | 5.0 | 2 | 3.0mm | 0.3mm min. |
| GA355ER7GB333KW01L | 250Vac(r.m.s.) | X7R (EIA) | 33000pF±10% | 5.7 | 5.0 | 2.5 | 3.0mm | 0.3mm min. |
| GA355ER7GB473KW01L | 250Vac(r.m.s.) | X7R (EIA) | 47000pF±10% | 5.7 | 5.0 | 2.5 | 3.0mm | 0.3mm min. |
| GA355XR7GB563KW06L | 250Vac(r.m.s.) | X7R (EIA) | 56000pF±10% | 5.7 | 5.0 | 2.9 | 3.0mm | 0.3mm min. |

For General Purpose GRW/GRJ/GR3 Series

Only for Applications

AC250V Type GA2 Series

Safety Standard Certified GA3 Series

Product Information

GA3 Series Specifications and Test Methods

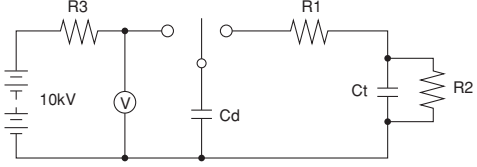
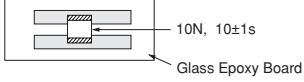
| No. | Item | Specifications | Test Method | | | | | | | | | | | | | | | | | | | | |
|------------|---|---|---|--------------------|--------------|--------------|---------|---|---|---------------------|--|------|------------------|---|--------------------------|---|------------------------|---|--------------------------|---|------------------------|---|--------------------------|
| 1 | Operating Temperature Range | -55 to +125°C | - | | | | | | | | | | | | | | | | | | | | |
| 2 | Appearance | No defects or abnormalities | Visual inspection | | | | | | | | | | | | | | | | | | | | |
| 3 | Dimensions | Within the specified dimensions | Using calipers and micrometers | | | | | | | | | | | | | | | | | | | | |
| 4 | Dielectric Strength | No defects or abnormalities | No failure should be observed when voltage in the table is applied between the terminations for 60±1 sec., provided the charge/discharge current is less than 50mA. <table border="1"> <thead> <tr> <th></th> <th>Test Voltage</th> </tr> </thead> <tbody> <tr> <td>Type GB</td> <td>DC1075V</td> </tr> <tr> <td>Type GC/GD</td> <td>AC1500V (r.m.s.)</td> </tr> <tr> <td>Type GF</td> <td>AC2000V (r.m.s.)</td> </tr> </tbody> </table> | | Test Voltage | Type GB | DC1075V | Type GC/GD | AC1500V (r.m.s.) | Type GF | AC2000V (r.m.s.) | | | | | | | | | | | | |
| | Test Voltage | | | | | | | | | | | | | | | | | | | | | | |
| Type GB | DC1075V | | | | | | | | | | | | | | | | | | | | | | |
| Type GC/GD | AC1500V (r.m.s.) | | | | | | | | | | | | | | | | | | | | | | |
| Type GF | AC2000V (r.m.s.) | | | | | | | | | | | | | | | | | | | | | | |
| 5 | Pulse Voltage (Application: Type GD/GF) | No self healing breakdowns or flash-overs have taken place in the capacitor. | 10 impulses of alternating polarity are subjected. (5 impulses for each polarity) The interval between impulses is 60 sec. Applied Pulse: 1.2/50µs Applied Voltage: 2.5kVo-p | | | | | | | | | | | | | | | | | | | | |
| 6 | Insulation Resistance (I.R.) | More than 6,000MΩ | The insulation resistance should be measured with DC500±50V and within 60±5 sec. of charging. | | | | | | | | | | | | | | | | | | | | |
| 7 | Capacitance | Within the specified tolerance | | | | | | | | | | | | | | | | | | | | | |
| 8 | Dissipation Factor (D.F.) Q | <table border="1"> <thead> <tr> <th>Char.</th> <th>Specification</th> </tr> </thead> <tbody> <tr> <td>X7R</td> <td>D.F. ≤ 0.025</td> </tr> <tr> <td>SL</td> <td>Q ≥ 400 + 20C*2 (C < 30pF) Q ≥ 1000 (C ≥ 30pF)</td> </tr> </tbody> </table> | Char. | Specification | X7R | D.F. ≤ 0.025 | SL | Q ≥ 400 + 20C*2 (C < 30pF) Q ≥ 1000 (C ≥ 30pF) | The capacitance/Q/D.F. should be measured at a frequency of 1±0.2kHz (SL char.: 1±0.2MHz) and a voltage of AC1±0.2V (r.m.s.). | | | | | | | | | | | | | | |
| Char. | Specification | | | | | | | | | | | | | | | | | | | | | | |
| X7R | D.F. ≤ 0.025 | | | | | | | | | | | | | | | | | | | | | | |
| SL | Q ≥ 400 + 20C*2 (C < 30pF) Q ≥ 1000 (C ≥ 30pF) | | | | | | | | | | | | | | | | | | | | | | |
| 9 | Capacitance Temperature Characteristics | <table border="1"> <thead> <tr> <th>Char.</th> <th>Capacitance Change</th> </tr> </thead> <tbody> <tr> <td>X7R</td> <td>Within ±15%</td> </tr> </tbody> </table> Temperature characteristic guarantee is -55 to +125°C <table border="1"> <thead> <tr> <th>Char.</th> <th>Temperature Coefficient</th> </tr> </thead> <tbody> <tr> <td>SL</td> <td>+350 to -1000ppm/°C</td> </tr> </tbody> </table> Temperature characteristic guarantee is +20 to +85°C | Char. | Capacitance Change | X7R | Within ±15% | Char. | Temperature Coefficient | SL | +350 to -1000ppm/°C | The capacitance measurement should be made at each step specified in the Table. <table border="1"> <thead> <tr> <th>Step</th> <th>Temperature (°C)</th> </tr> </thead> <tbody> <tr> <td>1</td> <td>25±2 (20±2 for SL char.)</td> </tr> <tr> <td>2</td> <td>Min. Operating Temp.±3</td> </tr> <tr> <td>3</td> <td>25±2 (20±2 for SL char.)</td> </tr> <tr> <td>4</td> <td>Max. Operating Temp.±2</td> </tr> <tr> <td>5</td> <td>25±2 (20±2 for SL char.)</td> </tr> </tbody> </table> SL char. : The capacitance should be measured at even 85°C between step 3 and step 4. •Pretreatment for X7R char. Perform a heat treatment at 150±1°C for 60±5 min. and then let sit for 24±2 hrs. at room condition.*1 | Step | Temperature (°C) | 1 | 25±2 (20±2 for SL char.) | 2 | Min. Operating Temp.±3 | 3 | 25±2 (20±2 for SL char.) | 4 | Max. Operating Temp.±2 | 5 | 25±2 (20±2 for SL char.) |
| Char. | Capacitance Change | | | | | | | | | | | | | | | | | | | | | | |
| X7R | Within ±15% | | | | | | | | | | | | | | | | | | | | | | |
| Char. | Temperature Coefficient | | | | | | | | | | | | | | | | | | | | | | |
| SL | +350 to -1000ppm/°C | | | | | | | | | | | | | | | | | | | | | | |
| Step | Temperature (°C) | | | | | | | | | | | | | | | | | | | | | | |
| 1 | 25±2 (20±2 for SL char.) | | | | | | | | | | | | | | | | | | | | | | |
| 2 | Min. Operating Temp.±3 | | | | | | | | | | | | | | | | | | | | | | |
| 3 | 25±2 (20±2 for SL char.) | | | | | | | | | | | | | | | | | | | | | | |
| 4 | Max. Operating Temp.±2 | | | | | | | | | | | | | | | | | | | | | | |
| 5 | 25±2 (20±2 for SL char.) | | | | | | | | | | | | | | | | | | | | | | |
| 10 | Appearance | No defects or abnormalities | As in Fig., discharge is made 50 times at 5 sec. intervals from the capacitor (Cd) charged at DC voltage of specified.  Ct: Capacitor under test Cd: 0.001µF R1: 1,000Ω R2: 100MΩ R3: Surge resistance | | | | | | | | | | | | | | | | | | | | |
| | I.R. | More than 1,000MΩ | | | | | | | | | | | | | | | | | | | | | |
| | Dielectric Strength | In accordance with item No.4 | | | | | | | | | | | | | | | | | | | | | |
| 11 | Adhesive Strength of Termination | No removal of the terminations or other defect should occur. | Solder the capacitor to the testing jig (glass epoxy board) shown in Fig. 1. Then apply 10N force in the direction of the arrow. The soldering should be done using the reflow method and should be conducted with care so that the soldering is uniform and free of defects such as heat shock.  Fig. 1 | | | | | | | | | | | | | | | | | | | | |

*1 "Room condition" Temperature: 15 to 35°C, Relative humidity: 45 to 75%, Atmospheric pressure: 86 to 106kPa

*2 "C" expresses nominal capacitance value (pF).

Continued on the following page. 

GA3 Series Specifications and Test Methods

↳ Continued from the preceding page.

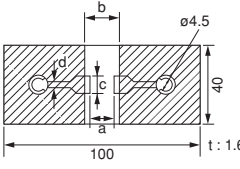
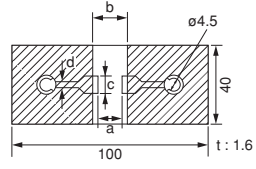
| No. | Item | Specifications | Test Method | | | | | | | | | | | | | | | | | | | | | | | | |
|----------|---|--|---|---------------|----------------|--------------|----|---|--------|---|--------------|--------|---|---------|-----|-----|-----|-----|---------|-----|-----|-----|---------|-----|-----|-----|---------|
| 12 | Vibration Resistance | Appearance | Solder the capacitor to the test jig (glass epoxy board). The capacitor should be subjected to a simple harmonic motion having a total amplitude of 1.5mm, the frequency being varied uniformly between the approximate limits of 10 and 55Hz. The frequency range, from 10 to 55Hz and return to 10Hz, should be traversed in approximately 1 min. This motion should be applied for a period of 2 hrs. in each of 3 mutually perpendicular directions (total of 6 hrs.). | | | | | | | | | | | | | | | | | | | | | | | | |
| | | Capacitance | | | | | | | | | | | | | | | | | | | | | | | | | |
| | D.F. Q | <table border="1" style="width: 100%; border-collapse: collapse;"> <thead> <tr style="background-color: #f2f2f2;"> <th style="width: 15%;">Char.</th> <th style="width: 85%;">Specification</th> </tr> </thead> <tbody> <tr> <td>X7R</td> <td>D.F. ≤ 0.025</td> </tr> <tr> <td>SL</td> <td>Q ≥ 400 + 20C*2 (C < 30pF) Q ≥ 1000 (C ≥ 30pF)</td> </tr> </tbody> </table> | Char. | Specification | X7R | D.F. ≤ 0.025 | SL | Q ≥ 400 + 20C*2 (C < 30pF) Q ≥ 1000 (C ≥ 30pF) | | | | | | | | | | | | | | | | | | | |
| Char. | Specification | | | | | | | | | | | | | | | | | | | | | | | | | | |
| X7R | D.F. ≤ 0.025 | | | | | | | | | | | | | | | | | | | | | | | | | | |
| SL | Q ≥ 400 + 20C*2 (C < 30pF) Q ≥ 1000 (C ≥ 30pF) | | | | | | | | | | | | | | | | | | | | | | | | | | |
| 13 | Deflection | No marking defects | Solder the capacitor to the testing jig (glass epoxy board) shown in Fig. 2. Then apply a force in the direction shown in Fig. 3. The soldering should be done using the reflow method and should be conducted with care so that the soldering is uniform and free of defects such as heat shock. | | | | | | | | | | | | | | | | | | | | | | | | |
| | |  <p style="text-align: center;">Fig. 2</p> <table border="1" style="width: 100%; border-collapse: collapse;"> <thead> <tr style="background-color: #f2f2f2;"> <th style="width: 15%;">L×W (mm)</th> <th colspan="4" style="width: 85%;">Dimension (mm)</th> </tr> <tr style="background-color: #f2f2f2;"> <th></th> <th>a</th> <th>b</th> <th>c</th> <th>d</th> </tr> </thead> <tbody> <tr> <td>4.5×2.0</td> <td>3.5</td> <td>7.0</td> <td>2.4</td> <td rowspan="4" style="text-align: center; vertical-align: middle;">1.0</td> </tr> <tr> <td>4.5×3.2</td> <td>3.5</td> <td>7.0</td> <td>3.7</td> </tr> <tr> <td>5.7×2.8</td> <td>4.5</td> <td>8.0</td> <td>3.2</td> </tr> <tr> <td>5.7×5.0</td> <td>4.5</td> <td>8.0</td> <td>5.6</td> </tr> </tbody> </table> | | L×W (mm) | Dimension (mm) | | | | | a | b | c | d | 4.5×2.0 | 3.5 | 7.0 | 2.4 | 1.0 | 4.5×3.2 | 3.5 | 7.0 | 3.7 | 5.7×2.8 | 4.5 | 8.0 | 3.2 | 5.7×5.0 |
| L×W (mm) | Dimension (mm) | | | | | | | | | | | | | | | | | | | | | | | | | | |
| | a | b | c | d | | | | | | | | | | | | | | | | | | | | | | | |
| 4.5×2.0 | 3.5 | 7.0 | 2.4 | 1.0 | | | | | | | | | | | | | | | | | | | | | | | |
| 4.5×3.2 | 3.5 | 7.0 | 3.7 | | | | | | | | | | | | | | | | | | | | | | | | |
| 5.7×2.8 | 4.5 | 8.0 | 3.2 | | | | | | | | | | | | | | | | | | | | | | | | |
| 5.7×5.0 | 4.5 | 8.0 | 5.6 | | | | | | | | | | | | | | | | | | | | | | | | |
| | |  <p style="text-align: center;">Fig. 3</p> | | | | | | | | | | | | | | | | | | | | | | | | | |
| 14 | Solderability of Termination | 75% of the terminations are to be soldered evenly and continuously. | Immerse the capacitor in a solution of ethanol (JIS-K-8101) and rosin (JIS-K-5902) (25% rosin in weight proportion). Immerse in solder solution for 2±0.5 sec. Immersing speed: 25±2.5mm/s Temp. of solder: 245±5°C Lead Free Solder (Sn-3.0Ag-0.5Cu) 235±5°C H60A or H63A Eutectic Solder | | | | | | | | | | | | | | | | | | | | | | | | |
| 15 | Resistance to Soldering Heat | Appearance | Preheat the capacitor as in table. Immerse the capacitor in solder solution at 260±5°C for 10±1 sec. Let sit at room condition*1 for 24±2 hrs., then measure. •Immersing speed: 25±2.5mm/s •Pretreatment for X7R char. Perform a heat treatment at 150±18°C for 60±5 min. and then let sit for 24±2 hrs. at room condition.*1 | | | | | | | | | | | | | | | | | | | | | | | | |
| | | Capacitance Change | | | | | | | | | | | | | | | | | | | | | | | | | |
| | | I.R. | | | | | | | | | | | | | | | | | | | | | | | | | |
| | Dielectric Strength | In accordance with item No.4 | *Preheating <table border="1" style="width: 100%; border-collapse: collapse;"> <thead> <tr style="background-color: #f2f2f2;"> <th style="width: 15%;">Step</th> <th style="width: 45%;">Temperature</th> <th style="width: 40%;">Time</th> </tr> </thead> <tbody> <tr> <td>1</td> <td>100 to 120°C</td> <td>1 min.</td> </tr> <tr> <td>2</td> <td>170 to 200°C</td> <td>1 min.</td> </tr> </tbody> </table> | Step | Temperature | Time | 1 | 100 to 120°C | 1 min. | 2 | 170 to 200°C | 1 min. | | | | | | | | | | | | | | | |
| Step | Temperature | Time | | | | | | | | | | | | | | | | | | | | | | | | | |
| 1 | 100 to 120°C | 1 min. | | | | | | | | | | | | | | | | | | | | | | | | | |
| 2 | 170 to 200°C | 1 min. | | | | | | | | | | | | | | | | | | | | | | | | | |

*1 "Room condition" Temperature: 15 to 35°C, Relative humidity: 45 to 75%, Atmospheric pressure: 86 to 106kPa
 *2 "C" expresses nominal capacitance value (pF).

Continued on the following page. ↗

For General Purpose GRM/GRJ/GR3 Series

Only for Applications

AC250V Type GA2 Series

Safety Standard Certified GA3 Series

Product Information

GA3 Series Specifications and Test Methods

Continued from the preceding page.

| No. | Item | Specifications | Test Method | | | | | | |
|---------------------|--|--------------------|--|--------------------|--------------------|-----|---|----|---|
| 16 | Temperature Cycle | Appearance | No marking defects | | | | | | |
| | | Capacitance Change | <table border="1"> <thead> <tr> <th>Char.</th> <th>Capacitance Change</th> </tr> </thead> <tbody> <tr> <td>X7R</td> <td>Within ±15%</td> </tr> <tr> <td>SL</td> <td>Within ±2.5% or ±0.25pF (Whichever is larger)</td> </tr> </tbody> </table> | Char. | Capacitance Change | X7R | Within ±15% | SL | Within ±2.5% or ±0.25pF (Whichever is larger) |
| | | | Char. | Capacitance Change | | | | | |
| | | X7R | Within ±15% | | | | | | |
| | | SL | Within ±2.5% or ±0.25pF (Whichever is larger) | | | | | | |
| D.F. Q | <table border="1"> <thead> <tr> <th>Char.</th> <th>Specification</th> </tr> </thead> <tbody> <tr> <td>X7R</td> <td>D.F. ≤0.05</td> </tr> <tr> <td>SL</td> <td>Q ≥ 400+20C*2 (C < 30pF) Q ≥ 1000 (C ≥ 30pF)</td> </tr> </tbody> </table> | Char. | Specification | X7R | D.F. ≤0.05 | SL | Q ≥ 400+20C*2 (C < 30pF) Q ≥ 1000 (C ≥ 30pF) | | |
| | Char. | Specification | | | | | | | |
| X7R | D.F. ≤0.05 | | | | | | | | |
| SL | Q ≥ 400+20C*2 (C < 30pF) Q ≥ 1000 (C ≥ 30pF) | | | | | | | | |
| I.R. | More than 3,000MΩ | | | | | | | | |
| Dielectric Strength | In accordance with item No.4 | | | | | | | | |
| 17 | Humidity (Steady State) | Appearance | No marking defects | | | | | | |
| | | Capacitance Change | <table border="1"> <thead> <tr> <th>Char.</th> <th>Capacitance Change</th> </tr> </thead> <tbody> <tr> <td>X7R</td> <td>Within ±15%</td> </tr> <tr> <td>SL</td> <td>Within ±5.0% or ±0.5pF (Whichever is larger)</td> </tr> </tbody> </table> | Char. | Capacitance Change | X7R | Within ±15% | SL | Within ±5.0% or ±0.5pF (Whichever is larger) |
| | | | Char. | Capacitance Change | | | | | |
| | | X7R | Within ±15% | | | | | | |
| | | SL | Within ±5.0% or ±0.5pF (Whichever is larger) | | | | | | |
| D.F. Q | <table border="1"> <thead> <tr> <th>Char.</th> <th>Specification</th> </tr> </thead> <tbody> <tr> <td>X7R</td> <td>D.F. ≤0.05</td> </tr> <tr> <td>SL</td> <td>Q ≥ 275+5/2C*2 (C < 30pF) Q ≥ 350 (C ≥ 30pF)</td> </tr> </tbody> </table> | Char. | Specification | X7R | D.F. ≤0.05 | SL | Q ≥ 275+5/2C*2 (C < 30pF) Q ≥ 350 (C ≥ 30pF) | | |
| | Char. | Specification | | | | | | | |
| X7R | D.F. ≤0.05 | | | | | | | | |
| SL | Q ≥ 275+5/2C*2 (C < 30pF) Q ≥ 350 (C ≥ 30pF) | | | | | | | | |
| I.R. | More than 3,000MΩ | | | | | | | | |
| Dielectric Strength | In accordance with item No.4 | | | | | | | | |
| 18 | Life | Appearance | No marking defects | | | | | | |
| | | Capacitance Change | <table border="1"> <thead> <tr> <th>Char.</th> <th>Capacitance Change</th> </tr> </thead> <tbody> <tr> <td>X7R</td> <td>Within ±20%</td> </tr> <tr> <td>SL</td> <td>Within ±3.0% or ±0.3pF (Whichever is larger)</td> </tr> </tbody> </table> | Char. | Capacitance Change | X7R | Within ±20% | SL | Within ±3.0% or ±0.3pF (Whichever is larger) |
| | | | Char. | Capacitance Change | | | | | |
| | | X7R | Within ±20% | | | | | | |
| | | SL | Within ±3.0% or ±0.3pF (Whichever is larger) | | | | | | |
| D.F. Q | <table border="1"> <thead> <tr> <th>Char.</th> <th>Specification</th> </tr> </thead> <tbody> <tr> <td>X7R</td> <td>D.F. ≤0.05</td> </tr> <tr> <td>SL</td> <td>Q ≥ 275+5/2C*2 (C < 30pF) Q ≥ 350 (C ≥ 30pF)</td> </tr> </tbody> </table> | Char. | Specification | X7R | D.F. ≤0.05 | SL | Q ≥ 275+5/2C*2 (C < 30pF) Q ≥ 350 (C ≥ 30pF) | | |
| | Char. | Specification | | | | | | | |
| X7R | D.F. ≤0.05 | | | | | | | | |
| SL | Q ≥ 275+5/2C*2 (C < 30pF) Q ≥ 350 (C ≥ 30pF) | | | | | | | | |
| I.R. | More than 3,000MΩ | | | | | | | | |
| Dielectric Strength | In accordance with item No.4 | | | | | | | | |

Fix the capacitor to the supporting jig (glass epoxy board) shown in Fig. 4.
 Perform the 5 cycles according to the 4 heat treatments listed in the following table.
 Let sit for 24±2 hrs. at room condition,*1 then measure.

| Step | Temperature (°C) | Time (min.) |
|------|------------------------|-------------|
| 1 | Min. Operating Temp.±3 | 30±3 |
| 2 | Room Temp. | 2 to 3 |
| 3 | Max. Operating Temp.±2 | 30±3 |
| 4 | Room Temp. | 2 to 3 |

•Pretreatment for X7R char.
 Perform a heat treatment at 150±1,8°C for 60±5 min. and then let sit for 24±2 hrs. at room condition.*1

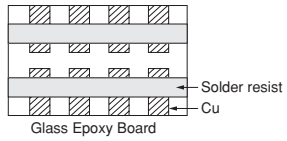

Fig. 4

Before this test, the test shown in the following is performed.
 ·Item 11 Adhesive Strength of Termination (applied force is 5N)
 ·Item 13 Deflection

Let the capacitor sit at 40±2°C and relative humidity of 90 to 95% for 500±24 hrs.
 Remove and let sit for 24±2 hrs. at room condition,*1 then measure.

•Pretreatment for X7R char.
 Perform a heat treatment at 150±1,8°C for 60±5 min. and then let sit for 24±2 hrs. at room condition.*1

Before this test, the test shown in the following is performed.
 ·Item 11 Adhesive Strength of Termination (apply force is 5N)
 ·Item 13 Deflection

Impulse Voltage
 Each individual capacitor should be subjected to a 2.5kV (Type GC/GF: 5kV) Impulse (the voltage value means zero to peak) for three times. Then the capacitors are applied to life test.

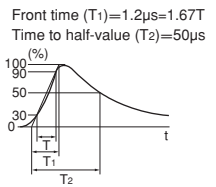

Apply voltage as in Table for 1,000 hrs. at 125±8°C, relative humidity 50% max.

| Type | Applied Voltage |
|------|--|
| GB | AC312.5V (r.m.s.), except that once each hour the voltage is increased to AC1,000V (r.m.s.) for 0.1 sec. |
| GC | AC425V (r.m.s.), except that once each hour the voltage is increased to AC1,000V (r.m.s.) for 0.1 sec. |
| GF | |
| GD | |

Let sit for 24±2 hrs. at room condition,*1 then measure.
 •Pretreatment for X7R char.
 Perform a heat treatment at 150±1,8°C for 60±5 min. and then let sit for 24±2 hrs. at room condition.*1

*1 "Room condition" Temperature: 15 to 35°C, Relative humidity: 45 to 75%, Atmospheric pressure: 86 to 106kPa
 *2 "C" expresses nominal capacitance value (pF).

Continued on the following page. ↗

GA3 Series Specifications and Test Methods

Continued from the preceding page.

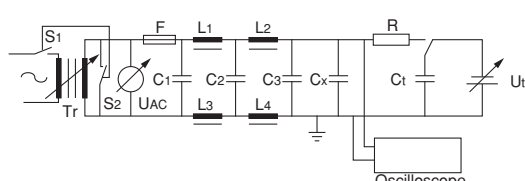
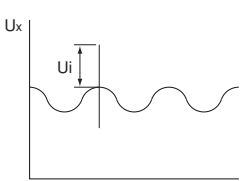
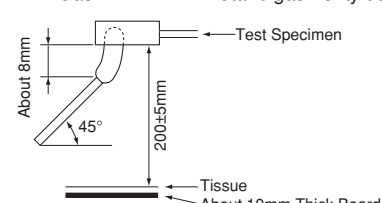
| No. | Item | Specifications | Test Method | | | | | | | | | | | | | | | | | | |
|--|---|---|---|---|----------------------|--|--|------------------|-------------|---------------------------|-------------|---------------------|--------------------|--|----------------------------|------|----|--------|-------|--------|-----|
| 19 | Humidity Loading | Appearance | No marking defects | Before this test, the test shown in the following is performed. ·Item 11 Adhesive Strength of Termination (apply force is 5N) ·Item 13 Deflection Apply the rated voltage at 40±2°C and relative humidity of 90 to 95% for 500± ^{±4} hrs. Remove and let sit for 24±2 hrs. at room condition,*1 then measure. •Pretreatment for X7R char. Perform a heat treatment at 150±1,8°C for 60±5 min. and then let sit for 24±2 hrs. at room condition.*1 | | | | | | | | | | | | | | | | | |
| | | Capacitance Change | Char. | | Capacitance Change | | | | | | | | | | | | | | | | |
| | | | X7R | | Within ±15% | | | | | | | | | | | | | | | | |
| | | SL | Within ±5.0% or ±0.5pF (Whichever is larger) | | | | | | | | | | | | | | | | | | |
| | | D.F. Q | Char. | | Specification | | | | | | | | | | | | | | | | |
| X7R | D.F. ≤0.05 | | | | | | | | | | | | | | | | | | | | |
| SL | Q ≥ 275 + 5/2C*2 (C < 30pF) Q ≥ 350 (C ≥ 30pF) | | | | | | | | | | | | | | | | | | | | |
| I.R. | More than 3,000MΩ | | | | | | | | | | | | | | | | | | | | |
| | Dielectric Strength | In accordance with item No.4 | | | | | | | | | | | | | | | | | | | |
| 20 | Active Flammability | The cheesecloth should not be on fire. | The capacitor should be individually wrapped in at least one but not more than two complete layers of cheesecloth. The capacitor should be subjected to 20 discharges. The interval between successive discharges should be 5 sec. The UAC should be maintained for 2 min. after the last discharge.  <table style="width: 100%; border: none;"> <tr> <td>C1,2 : 1μF±10%</td> <td>C3 : 0.033μF±5% 10kV</td> </tr> <tr> <td>L1 to 4 : 1.5mH±20% 16A Rod core choke</td> <td></td> </tr> <tr> <td>Ct : 3μF±5% 10kV</td> <td>R : 100Ω±2%</td> </tr> <tr> <td>Cx : Capacitor under test</td> <td>UAC : UR±5%</td> </tr> <tr> <td>F : Fuse, Rated 16A</td> <td>UR : Rated Voltage</td> </tr> <tr> <td></td> <td>Ut : Voltage applied to Ct</td> </tr> </table>  <table style="width: 100%; border: none;"> <thead> <tr> <th style="border: 1px solid black;">Type</th> <th style="border: 1px solid black;">Ui</th> </tr> </thead> <tbody> <tr> <td style="border: 1px solid black;">GD, GB</td> <td style="border: 1px solid black;">2.5kV</td> </tr> <tr> <td style="border: 1px solid black;">GC, GF</td> <td style="border: 1px solid black;">5kV</td> </tr> </tbody> </table> | C1,2 : 1μF±10% | C3 : 0.033μF±5% 10kV | L1 to 4 : 1.5mH±20% 16A Rod core choke | | Ct : 3μF±5% 10kV | R : 100Ω±2% | Cx : Capacitor under test | UAC : UR±5% | F : Fuse, Rated 16A | UR : Rated Voltage | | Ut : Voltage applied to Ct | Type | Ui | GD, GB | 2.5kV | GC, GF | 5kV |
| | | | | C1,2 : 1μF±10% | C3 : 0.033μF±5% 10kV | | | | | | | | | | | | | | | | |
| L1 to 4 : 1.5mH±20% 16A Rod core choke | | | | | | | | | | | | | | | | | | | | | |
| Ct : 3μF±5% 10kV | R : 100Ω±2% | | | | | | | | | | | | | | | | | | | | |
| Cx : Capacitor under test | UAC : UR±5% | | | | | | | | | | | | | | | | | | | | |
| F : Fuse, Rated 16A | UR : Rated Voltage | | | | | | | | | | | | | | | | | | | | |
| | Ut : Voltage applied to Ct | | | | | | | | | | | | | | | | | | | | |
| Type | Ui | | | | | | | | | | | | | | | | | | | | |
| GD, GB | 2.5kV | | | | | | | | | | | | | | | | | | | | |
| GC, GF | 5kV | | | | | | | | | | | | | | | | | | | | |
| 21 | Passive Flammability | The burning time should not exceed 30 sec. The tissue paper should not ignite. | The capacitor under test should be held in the flame in the position which best promotes burning. Each specimen should be exposed to the flame only once. Time of exposure to flame: 30 sec. Length of flame : 12±1mm Gas burner : Length 35mm min. Inside Dia. 0.5±0.1mm Outside Dia. 0.9mm max. Gas : Butane gas Purity 95% min. | | | | | | | | | | | | | | | | | | |
| | | | |  | | | | | | | | | | | | | | | | | |

*1 "Room condition" Temperature: 15 to 35°C, Relative humidity: 45 to 75%, Atmospheric pressure: 86 to 106kPa

*2 "C" expresses nominal capacitance value (pF).

For General Purpose GRM/GRJ/GR3 Series

Only for Applications

AC250V Type GA2 Series

Safety Standard Certified GA3 Series

Product Information

GRM/GRJ/GR3/GR4/GR7/GA2/GA3 Series Reference Data (Typical Example)

Capacitance - Temperature Characteristics

C0G/U2J/SL Characteristics

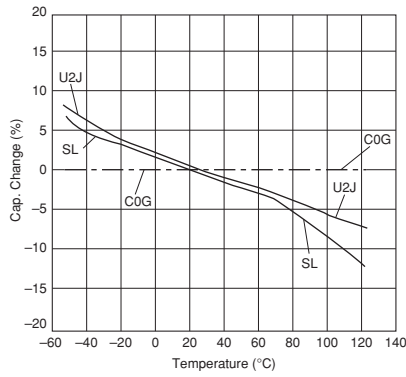

X7R Characteristics

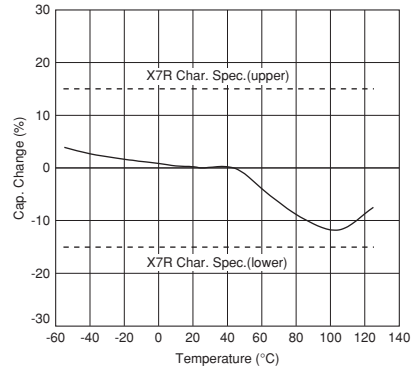

GR4 Series

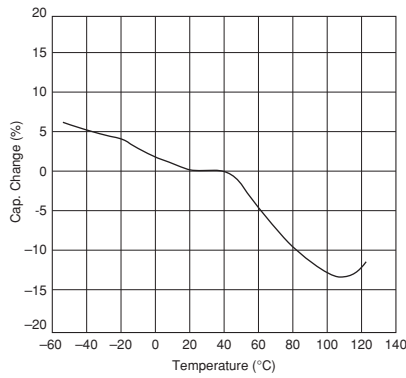

X7T Characteristics

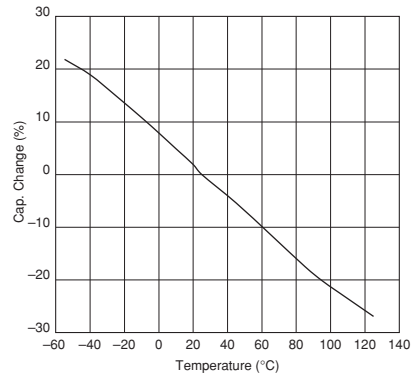

Impedance - Frequency Characteristics

GRM Series (C0G Char. 250V)

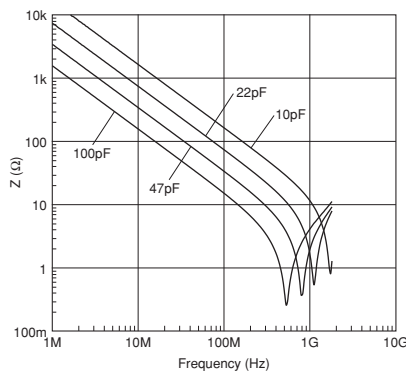

GRM Series (C0G Char. 630V)

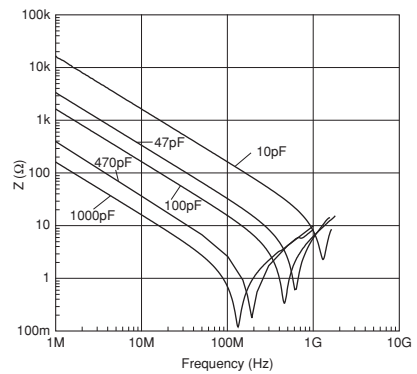

Continued on the following page.

For General Purpose GRM/GRJ/GR3 Series
 Only for Applications
 AC250V Type GA2 Series
 Safety Standard Certified GA3 Series
 Product Information Reference Data

GRM/GRJ/GR3/GR4/GR7/GA2/GA3 Series Reference Data (Typical Example)

Continued from the preceding page.

Impedance - Frequency Characteristics

GRM Series (C0G Char. 1kV)

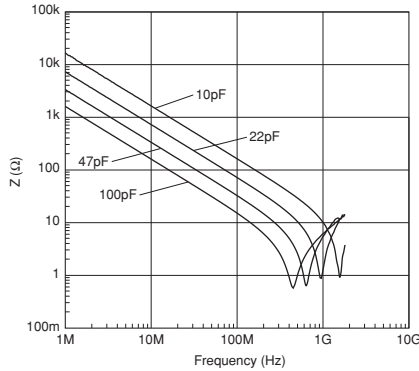

GRM Series (X7R Char. 250V)

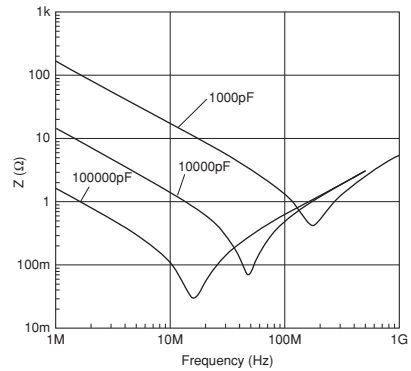

GRM Series (X7R Char. 630V)

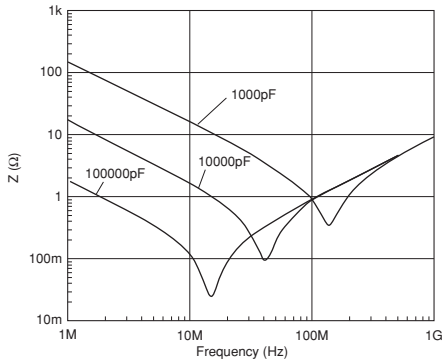

GRJ Series (X7R Char. 250V)

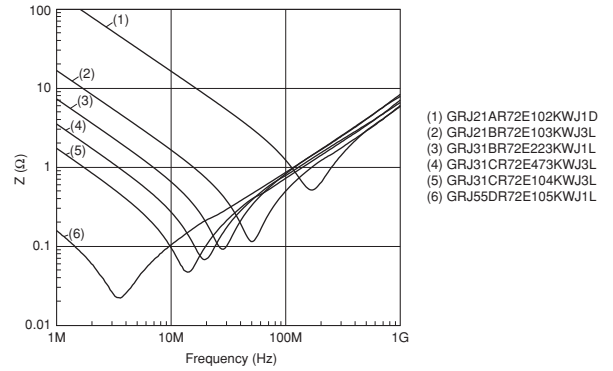

GR3 Series (X7T Char. 250V)

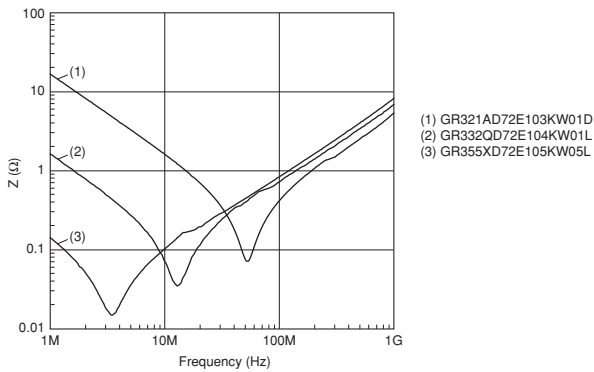

GR4 Series

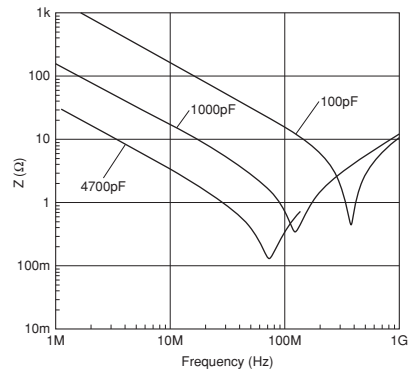

GA2 Series

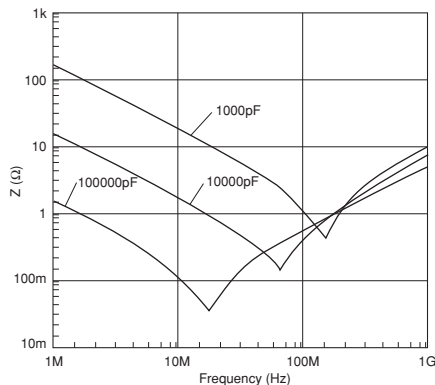

GA3 Series (Type GF)

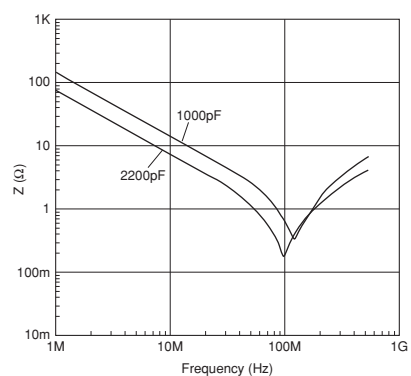

Continued on the following page. ↗

GRM/GRJ/GR3/GR4/GR7/GA2/GA3 Series Reference Data (Typical Example)

Continued from the preceding page.

Impedance - Frequency Characteristics

GA3 Series (Type GD)

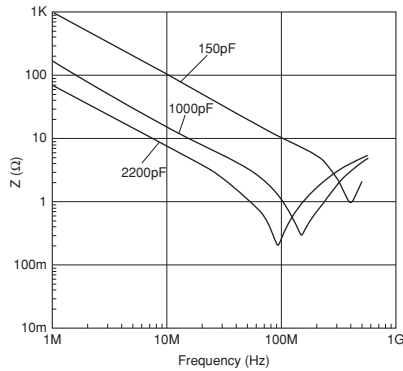

GA3 Series (Type GB)

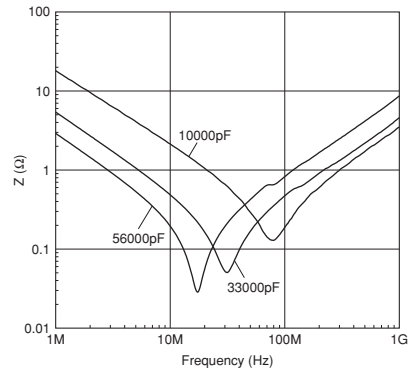

Capacitance - AC Voltage Characteristics

GA3 Series (Type GF/GD, X7R Char.)

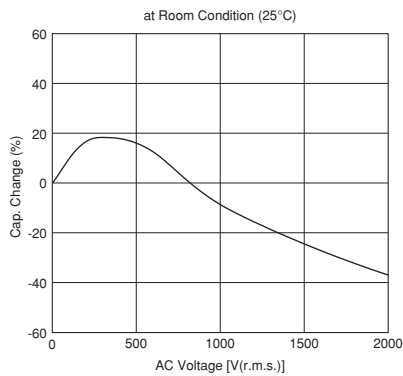

GA3 Series (Type GB)

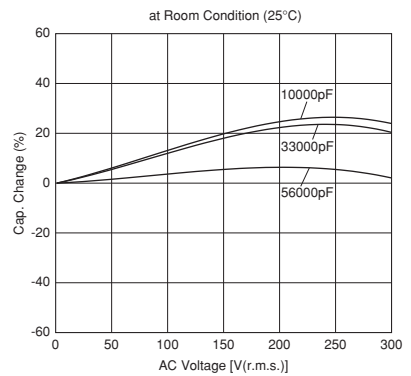

Capacitance - DC Bias Characteristics

GRM/GR3 Series

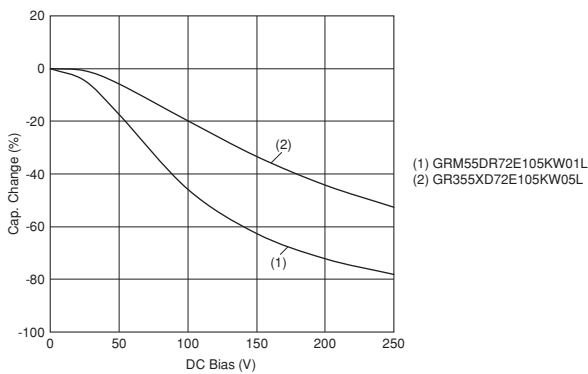

GR7 Series

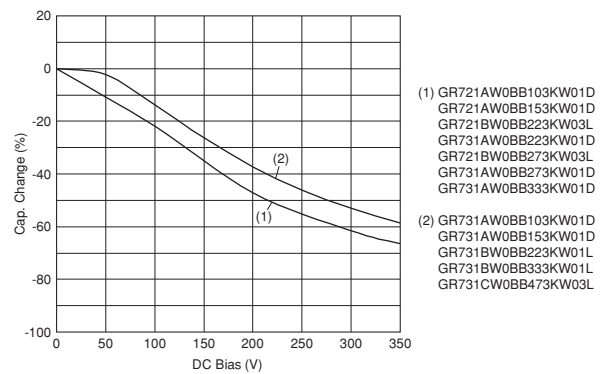

- (1) GR721AW0BB103KW01D
 GR721AW0BB153KW01D
 GR721BW0BB223KW03L
 GR731AW0BB223KW01D
 GR721BW0BB273KW03L
 GR731AW0BB273KW01D
 GR731AW0BB333KW01D
- (2) GR731AW0BB103KW01D
 GR731AW0BB153KW01D
 GR731BW0BB223KW01L
 GR731BW0BB333KW01L
 GR731CW0BB473KW03L

For General Purpose GRM/GRJ/GR3 Series
 Only for Applications
 AC250V Type GA2 Series
 Safety Standard Certified GA3 Series
 Product Information Reference Data

Package

Taping is the standard packaging method.

■ Minimum Quantity Guide

| Part Number | | Dimensions (mm) | | | Quantity (pcs.) | |
|---|-----------------------------|-----------------|------|------|-----------------|---------------|
| | | | | | ø180mm Reel | |
| | | L | W | T | Paper Tape | Embossed Tape |
| 250Vdc min. For General Purpose & Only for Applications | GRM18 | 1.6 | 0.8 | 0.8 | 4,000 | - |
| | GRJ21/GRM21/GR321/ GR721 | 2.0 | 1.25 | 1.0 | 4,000 | - |
| | | | | 1.25 | - | 3,000 |
| | GRJ31/GRM31/GR331/ GR731 | 3.2 | 1.6 | 1.0 | 4,000 | - |
| | | | | 1.25 | - | 3,000 |
| | | | | 1.6 | - | 2,000 |
| | GRJ32/GRM32/GR332 | 3.2 | 2.5 | 1.0 | 4,000 | - |
| | | | | 1.25 | - | 3,000 |
| | | | | 1.5 | - | 2,000 |
| | GRM42/GR442 | 4.5 | 2.0 | 1.0 | - | 3,000 |
| | | | | 1.5 | - | 2,000 |
| | GRJ43/GRM43/GR343/ GR443 | 4.5 | 3.2 | 1.5 | - | 1,000 |
| 2.0 | | | | - | 1,000 | |
| 2.5 | | | | - | 500 | |
| GRM55 | 5.7 | 5.0 | 1.5 | - | 1,000 | |
| GRJ55/GRM55/GR355/ GR455 | 5.7 | 5.0 | 2.0 | - | 1,000 | |
| GR355 | 5.7 | 5.0 | 2.7 | - | 500 | |
| AC250V | GA242 | 4.5 | 2.0 | 1.5 | - | 2,000 |
| | GA243 | 4.5 | 3.2 | 1.5 | - | 1,000 |
| | | | | 2.0 | - | 1,000 |
| GA255 | 5.7 | 5.0 | 2.0 | - | 1,000 | |
| Safety Std. Certification | GA342 | 4.5 | 2.0 | 1.0 | - | 3,000 |
| | | | | 1.5 | - | 2,000 |
| | | | | 2.0 | - | 2,000 |
| | GA343 | 4.5 | 3.2 | 1.5 | - | 1,000 |
| | | | | 2.0 | - | 1,000 |
| | GA352 | 5.7 | 2.8 | 1.5 | - | 1,000 |
| | GA355 | 5.7 | 5.0 | 1.5 | - | 1,000 |
| | | | | 2.0 | - | 1,000 |
| 2.5 | | | | - | 500 | |
| 2.7 | | | | - | 500 | |
| | | | 2.9 | - | 500 | |

Continued on the following page. ↗

For General Purpose
GRM/GRJ/GR3 Series

Only for Applications

AC250V Type
GA2 Series

Safety Standard
Certified GA3 Series

Product Information
Package

Package

☐ Continued from the preceding page.

■ Tape Carrier Packaging

(1) Appearance of Taping

① Embossed Tape

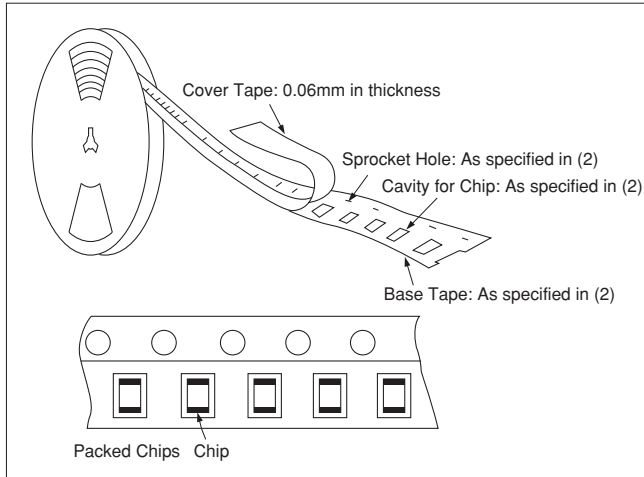

② Paper Tape

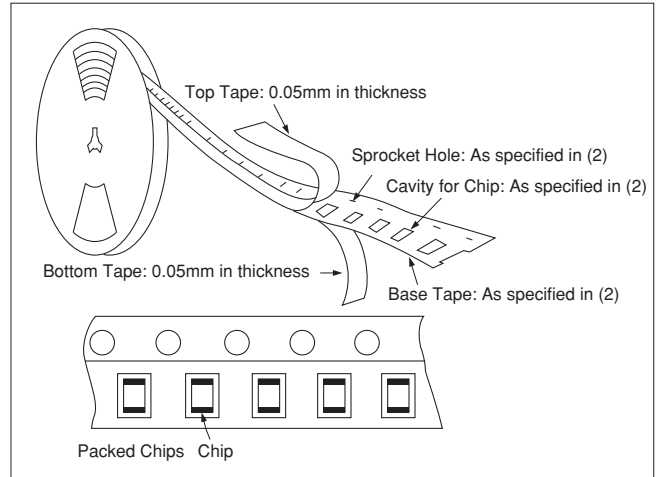

(2) Dimensions of Tape

① Embossed Tape

8mm width, 4mm pitch Tape

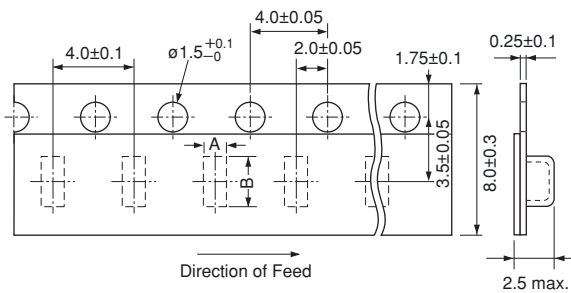

| Part Number | A* | B* |
|---------------------------------------|------|------|
| GRJ21/GRM21/GR321/GR721 (T≥1.25mm) | 1.45 | 2.25 |
| GRJ31/GRM31/GR331/GR731 (T≥1.25mm) | 2.0 | 3.6 |
| GRJ32/GRM32/GR332 (T≥1.25mm) | 2.9 | 3.6 |

*Nominal Value

12mm width, 8mm/4mm pitch Tape

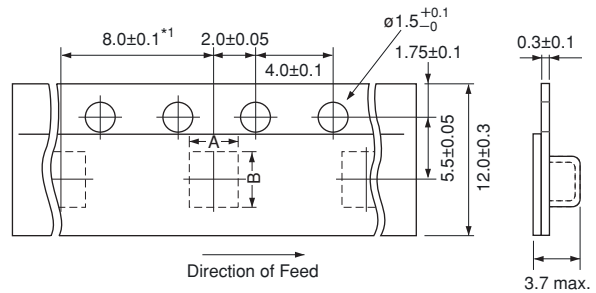

| Part Number | A* | B* |
|-------------------------------------|-----|-----|
| GRM42/GR442/GA242/GA342 | 2.5 | 5.1 |
| GRJ43/GRM43/GR343/GR443/GA243/GA343 | 3.6 | 4.9 |
| GA352 | 3.2 | 6.1 |
| GRJ55/GRM55/GR355/GR455/GA255/GA355 | 5.4 | 6.1 |

*1 4.0±0.1mm in case of GRM42/GR442/GA242/GA342

*Nominal Value

(in mm)

② Paper Tape

8mm width, 4mm pitch Tape

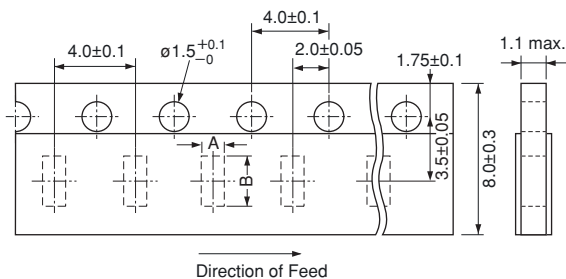

| Part Number | A* | B* |
|--------------------------------------|------|------|
| GRM18 | 1.05 | 1.85 |
| GRJ21/GRM21/GR321/GR721 (T=1.0mm) | 1.45 | 2.25 |
| GRM31/GR331/GR731 (T=1.0mm) | 2.0 | 3.6 |
| GRM32 (T=1.0mm) | 2.9 | 3.6 |

*Nominal Value

(in mm)

Package

Continued from the preceding page.

(3) Dimensions of Reel

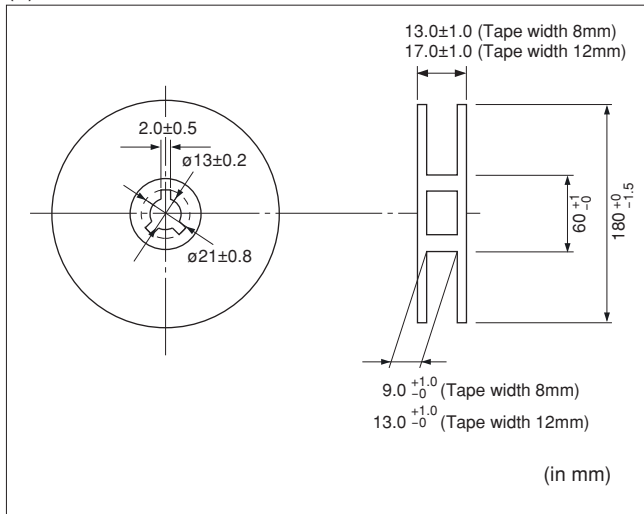

(4) Taping Method

- ① Tapes for capacitors are wound clockwise. The sprocket holes are to the right as the tape is pulled toward the user.
- ② Part of the leader and part of the empty tape should be attached to the end of the tape as shown at right.
- ③ The top tape or cover tape and base tape are not attached at the end of the tape for a minimum of 5 pitches.
- ④ Missing capacitors number within 0.1% of the number per reel or 1 pc, whichever is greater, and are not continuous.
- ⑤ The top tape or cover tape and bottom tape should not protrude beyond the edges of the tape and should not cover sprocket holes.
- ⑥ Cumulative tolerance of sprocket holes, 10 pitches: $\pm 0.3\text{mm}$.
- ⑦ Peeling off force: 0.1 to 0.6N in the direction shown at right.

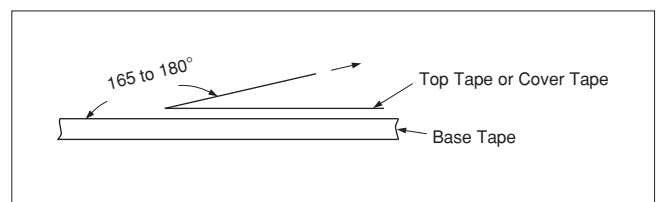
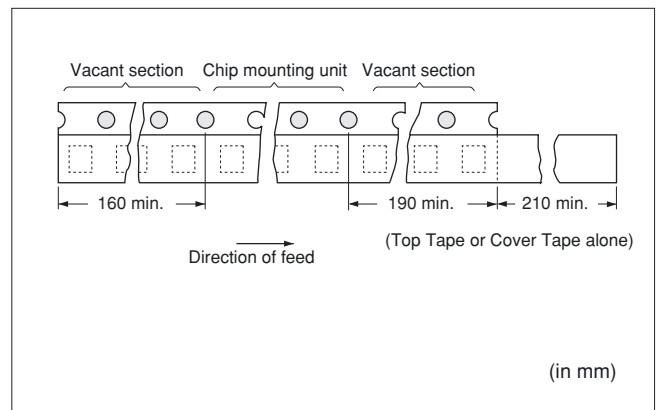

For General Purpose
 GRM/GRJ/GR3 Series

Only for Applications

AC250V Type
 GA2 Series

Safety Standard
 Certified GA3 Series

Product Information
 Package

⚠Caution/Notice

⚠Caution

Notice

- Storage and Operation Conditions 189
- Rating 189
 - 1. Operating Voltage 189
 - 2. Operating Temperature, Self-generated Heat, and Load Reduction at High-frequency Voltage Condition 189
 - 3. Fail-safe 191
 - 4. Test Condition for AC Withstanding Voltage 191
 - (1) Test Equipment 191
 - (2) Voltage Applied Method 191
- Soldering and Mounting 191
 - 1. Vibration and Impact 191
 - 2. Circuit Board Material 191
 - 3. Land Layout for Cropping PC Board 191
 - 4. Reflow Soldering 192
 - 5. Flow Soldering 193
 - 6. Correction with a Soldering Iron 194
 - 7. Washing 194
 - 8. Handling 194

- Rating 195
 - 1. Capacitance Change of Capacitor 195
 - 2. Performance Check by Equipment 195
- Soldering and Mounting 195
 - 1. Construction of Board Pattern 195
 - 2. Mounting of Chips 196
 - 3. Soldering 197
 - (1) Limit of losing effective area of the terminations and conditions needed for soldering. 197
 - (2) Flux Application 197
 - (3) Solder 197
 - 4. Cleaning 197
 - 5. Resin Coating 197

For General Purpose GRM/GRJ/GR3 Series
 Only for Applications
 AC250V Type GA2 Series
 Safety Standard Certified GA3 Series
 Product Information ⚠Caution/Notice

⚠Caution

■ Storage and Operation Conditions

Do not use or store capacitors in a corrosive atmosphere, especially where chloride gas, sulfide gas, acid, alkali, salt or the like are present. In addition, avoid exposure to moisture. Before cleaning, bonding or molding this product, verify that these processes do not affect product quality by testing the performance of a cleaned, bonded or molded product in the intended equipment. Store the capacitors where the temperature and relative humidity do not exceed 5 to 40 degrees centigrade and 20 to 70%. Use capacitors within 6 months of delivery. Check the solderability after 6 months or more.

■ Rating

1. Operating Voltage

When DC-rated capacitors are to be used in AC or ripple current circuits, be sure to maintain the V_{p-p} value of the applied voltage or the V_{0-p} which contains DC bias within the rated voltage range.

When the voltage is applied to the circuit, starting or stopping may generate irregular voltage for a transit period because of resonance or switching. Be sure to use a capacitor with a rated voltage range that includes these irregular voltages.

When DC-rated capacitors are to be used in input circuits from a commercial power source (AC filter), be sure to use Safety Certified Capacitors because various regulations for withstanding voltage or impulses, established for all equipment, should be taken into consideration.

| Voltage | DC Voltage | DC+AC Voltage | AC Voltage | Pulse Voltage (1) | Pulse Voltage (2) |
|------------------------|------------|---------------|------------|-------------------|-------------------|
| Positional Measurement | | | | | |

2. Operating Temperature, Self-generated Heat, and Load Reduction at High-frequency Voltage Condition

Keep the surface temperature of a capacitor below the upper limit of its rated operating temperature range. Be sure to take into account the heat generated by the capacitor itself. When the capacitor is used in a high-frequency voltage, pulse voltage, it may self-generate heat due to dielectric loss.

(1) In the case of X7R, X7T char.

Applied voltage should be the load such as self-generated heat is within 20°C on the condition of atmosphere temperature 25°C. When measuring, use a thermocouple of small thermal capacity -K of $\phi 0.1$ mm in conditions where the capacitor is not affected by radiant heat from other components or surrounding ambient fluctuations. Excessive heat may lead to deterioration of the capacitor's characteristics and reliability. (Never attempt to perform measurement with the cooling fan running. Otherwise, accurate measurement cannot be ensured.)

Continued on the following page.

For General Purpose
GRM/GRJ/GR3 Series

Only for Applications

AC250V Type
GA2 Series

Safety Standard
Certified GA3 Series

Product Information
⚠Caution

⚠Caution

↳ Continued from the preceding page.

(2) In case of C0G, U2J char.

Due to the low self-heating characteristics of low-dissipation capacitors, the allowable electric power of these capacitors is generally much higher than that of X7R characteristic capacitors.

When a high frequency voltage that causes 20°C self-heating to the capacitor is applied, it will exceed the capacitor's allowable electric power.

The frequency of the applied sine wave voltage should be less than 500kHz (less than 100kHz in the case of rated voltage: DC3.15kV). The applied voltage should be less than the value shown in figure below.

In the case of non-sine wave that includes a harmonic frequency, please contact our sales representatives or product engineers. Excessive heat may lead to deterioration of the capacitor's characteristics and reliability. (Never attempt to perform measurement with the cooling fan running. Otherwise, accurate measurement cannot be ensured.)

<C0G char., Rated Voltage: DC3.15kV>

The capacitors less than 22pF can be applied maximum 4.0kV peak to peak at 100kHz or less only for the ballast or the resonance usage in the LCD backlight inverter circuit.

<Capacitor Selection Tool>

We are also offering free software/the capacitor selection tool: "Murata Medium Voltage Capacitors Selection Tool by Voltage Form," which will assist you in selecting a suitable capacitor.

The software can be downloaded from Murata's Website. (<http://www.murata.com/designlib/mmcsv/index.html>). By inputting capacitance values and the applied voltage waveform of the specific capacitor series, this software will calculate the capacitor's power consumption and list suitable capacitors (non-sine wave is also available).

The temperature of the surface of capacitor: 125°C or less (including self-heating)

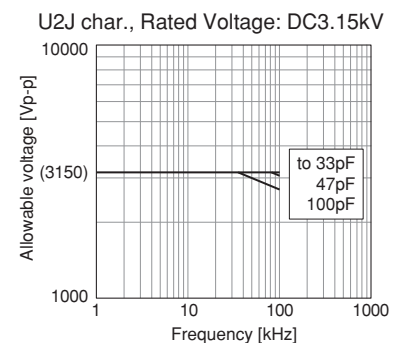
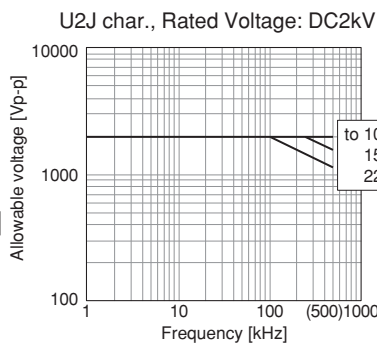
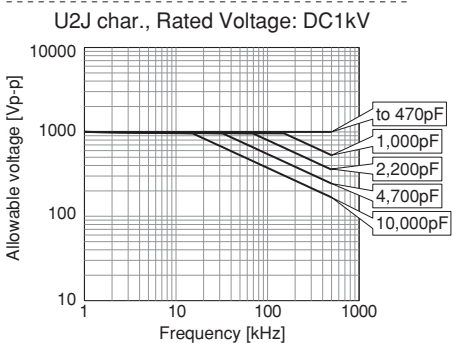
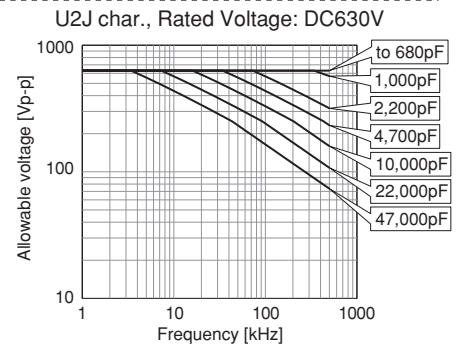
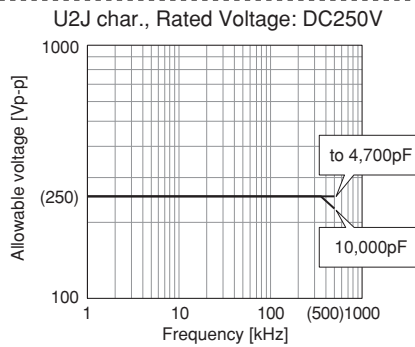
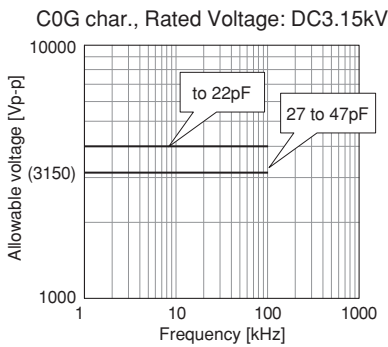
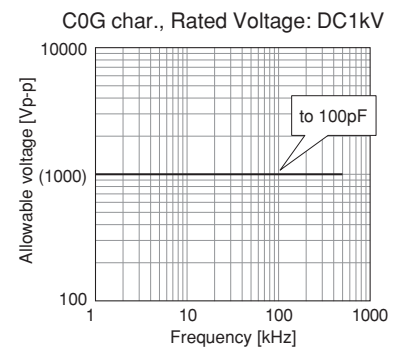
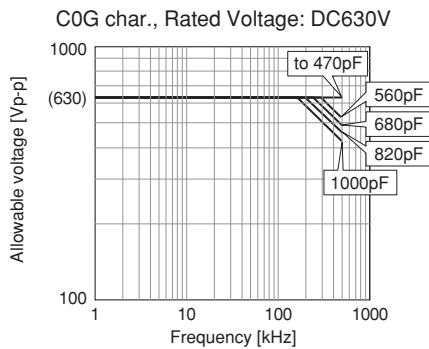
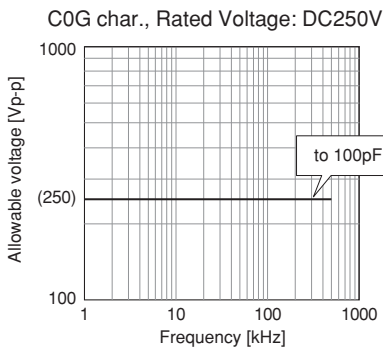

The sine-wave frequency VS allowable voltage

Continued on the following page. ↗

For General Purpose GRM/GRU/GR3 Series
 Only for Applications
 AC250V Type GA2 Series
 Safety Standard Certified GA3 Series
 Product Information ⚠Caution

⚠Caution

☐ Continued from the preceding page.

3. Fail-safe

Failure of a capacitor may result in a short circuit. Be sure to provide an appropriate fail-safe function such as a fuse on your product to help eliminate possible electric shock, fire, or fumes.

Please consider using fuses on each AC line if the capacitors are used between the AC input lines and earth (line bypass capacitors), to prepare for the worst case, such as a short circuit.

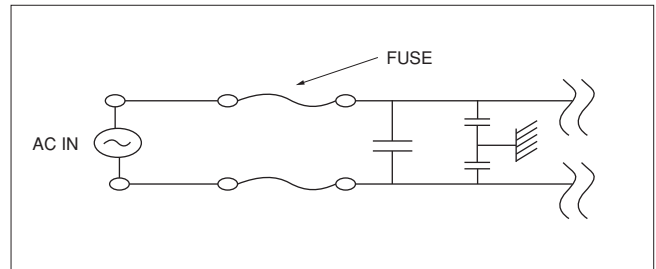

4. Test Condition for AC Withstanding Voltage

(1) Test Equipment

Tests for AC withstanding voltage should be made with equipment capable of creating a wave similar to a 50/60 Hz sine wave.

If the distorted sine wave or overload exceeding the specified voltage value is applied, a defect may be caused.

(2) Voltage Applied Method

The capacitor's leads or terminals should be firmly connected to the output of the withstanding voltage test equipment, and then the voltage should be raised from near zero to the test voltage. If the test voltage is applied directly to the capacitor without raising it from near zero, it should be applied with the zero cross.* At the end of the test time, the test voltage should be reduced to near zero, and then the capacitor's leads or terminals should be taken off the output of the withstanding voltage test equipment. If the test voltage is applied directly to the capacitor without raising it from near zero, surge voltage may occur and cause a defect.

*ZERO CROSS is the point where voltage sine wave passes 0V.

- See the figure at right -

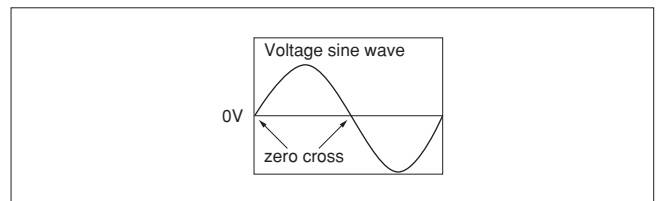

■ Soldering and Mounting

1. Vibration and Impact

Do not expose a capacitor to excessive shock or vibration during use.

2. Circuit Board Material

It is possible for the chip to crack by the expansion and shrinkage of a metal board.

Please contact us if you want to use our ceramic capacitors on a metal board such as Aluminum.

3. Land Layout for Cropping PC Board

Choose a mounting position that minimizes the stress imposed on the chip during flexing or bending of the board.

[Component Direction]

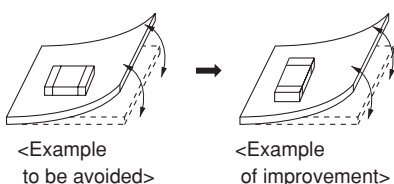

[Chip Mounting Close to Board Separation Point]

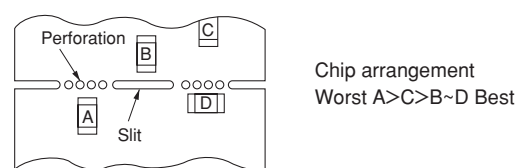

Continued on the following page. ↗

⚠Caution

☐ Continued from the preceding page.

4. Reflow Soldering

- When components are exposed to sudden heat, their mechanical strength can be decreased due to the extreme temperature changes which can cause flexing and result in internal mechanical damage, which will cause the parts to fail. In order to prevent mechanical damage, preheating is required for both the components and the PCB board. Preheating conditions are shown in Table 1. It is required to keep the temperature differential between the soldering and the components surface (ΔT) as small as possible.
- Solderability of Tin plating termination chips might be deteriorated when low temperature soldering profile where peak solder temperature is below the Tin melting point is used. Please confirm the solderability of Tin plating termination chips before use.
- When components are immersed in solvent after mounting, be sure to maintain the temperature difference (ΔT) between the component and solvent within the range shown in the Table 1.

Table 1

| Part Number | Temperature Differential |
|-------------------|-----------------------------------|
| G□□18/21/31 | $\Delta T \leq 190^\circ\text{C}$ |
| G□□32/42/43/52/55 | $\Delta T \leq 130^\circ\text{C}$ |

Recommended Conditions

| | Pb-Sn Solder | | Lead Free Solder |
|------------------|-----------------|--------------|-----------------------|
| | Infrared Reflow | Vapor Reflow | |
| Peak Temperature | 230-250°C | 230-240°C | 240-260°C |
| Atmosphere | Air | Air | Air or N ₂ |

Pb-Sn Solder: Sn-37Pb
 Lead Free Solder: Sn-3.0Ag-0.5Cu

[Standard Conditions for Reflow Soldering]

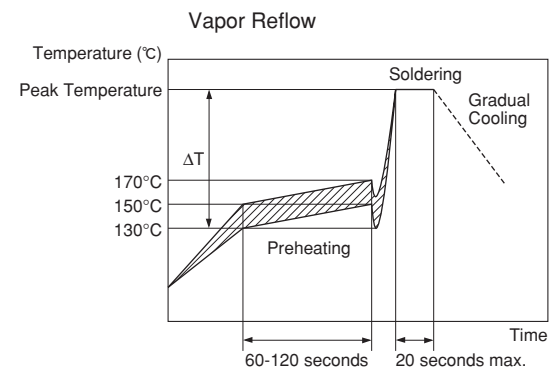
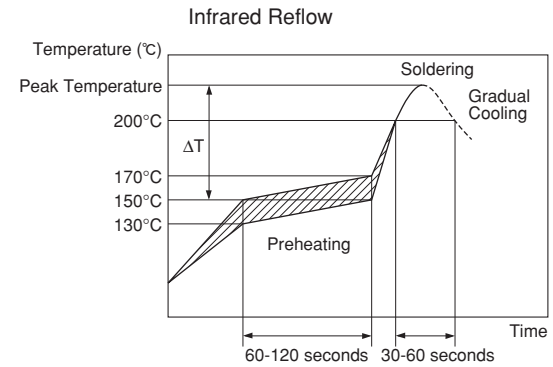

[Allowable Soldering Temperature and Time]

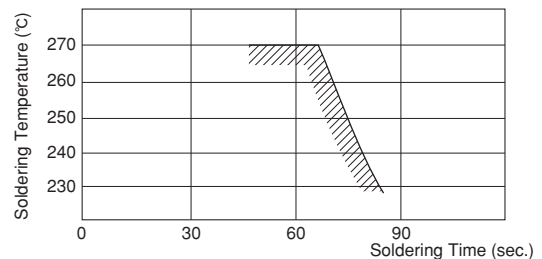

In the case of repeated soldering, the accumulated soldering time must be within the range shown above.

Optimum Solder Amount for Reflow Soldering

- Overly thick application of solder paste results in excessive solder fillet height. This makes the chip more susceptible to mechanical and thermal stress on the board and may cause cracked chips.
- Too little solder paste results in a lack of adhesive strength on the outer electrode, which may result in chips breaking loose from the PCB.
- Make sure the solder has been applied smoothly to the end surface to a height of 0.2mm min.

[Optimum Solder Amount for Reflow Soldering]

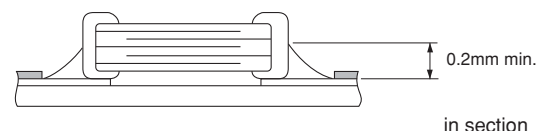

Inverting the PCB

Make sure not to impose an abnormal mechanical shock on the PCB.

Continued on the following page. ↗

For General Purpose GRM/GRU/GR3 Series
 Only for Applications AC250V Type GA2 Series
 Safety Standard Certified GA3 Series
 Product Information ⚠Caution

⚠Caution

☐ Continued from the preceding page.

5. Flow Soldering

- When components are exposed to sudden heat, their mechanical strength can be decreased due to the extreme temperature changes which can cause flexing and result in internal mechanical damage, which will cause the parts to fail. Additionally, an excessively long soldering time or high soldering temperature results in leaching by the outer electrodes, causing poor adhesion or a reduction in capacitance value due to loss of contact between electrodes and end termination.
- In order to prevent mechanical damage, preheating is required for both the components and the PCB board. Preheating conditions are shown in Table 2. It is required to keep temperature differential between the soldering and the components surface (ΔT) as small as possible.
- When components are immersed in solvent after mounting, be sure to maintain the temperature difference between the component and solvent within the range shown in Table 2.
 Do not apply flow soldering to chips not listed in Table 2.

Table 2

| Part Number | Temperature Differential |
|-------------|-----------------------------------|
| G□□18/21/31 | $\Delta T \leq 150^\circ\text{C}$ |

Recommended Conditions

| | Pb-Sn Solder | Lead Free Solder |
|------------------|--------------|------------------|
| Peak Temperature | 240-250°C | 250-260°C |
| Atmosphere | Air | N ₂ |

Pb-Sn Solder: Sn-37Pb
 Lead Free Solder: Sn-3.0Ag-0.5Cu

- **Optimum Solder Amount for Flow Soldering**
 The top of the solder fillet should be lower than the thickness of components. If the solder amount is excessively large, the risk of cracking is higher during board bending or under any other stressful conditions.

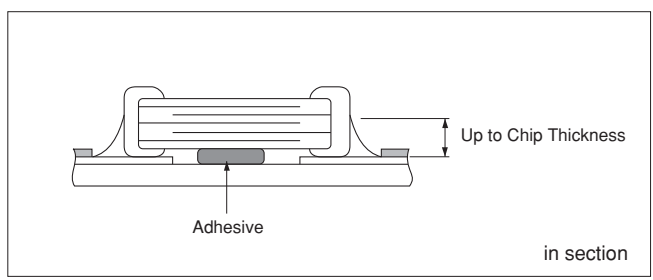
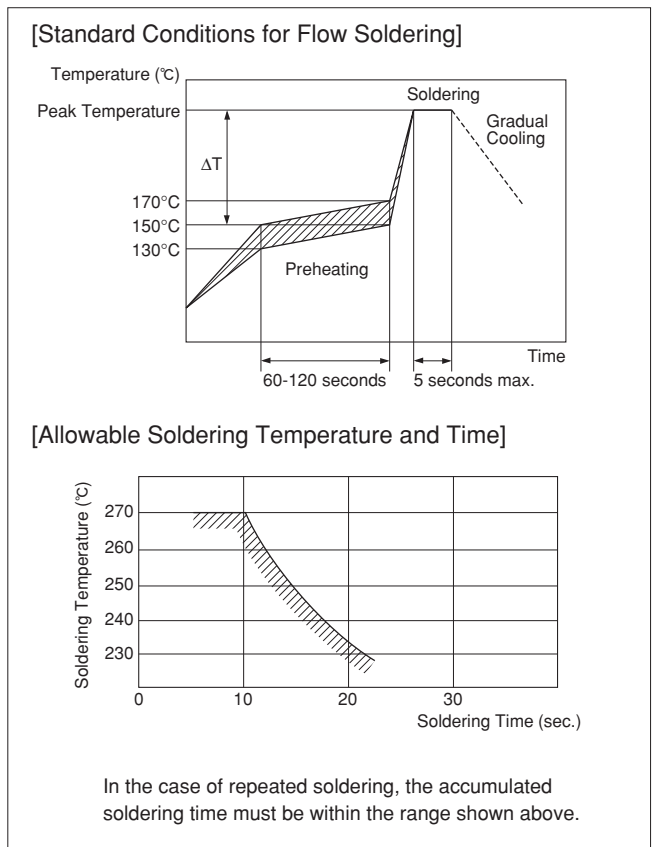

Continued on the following page. ☐

For General Purpose
 GRM/GRJ/GR3 Series

Only for Applications

AC250V Type
 GA2 Series

Safety Standard
 Certified GA3 Series

Product Information
 ⚠Caution

⚠Caution

☐ Continued from the preceding page.

6. Correction with a Soldering Iron

- When sudden heat is applied to the components by use of a soldering iron, the mechanical strength of the components will decrease because the extreme temperature change causes deformations inside the components.

In order to prevent mechanical damage to the components, preheating is required for both the components and the PCB board.

Preheating conditions, (The "Temperature of the Soldering Iron Tip", "Preheating Temperature," "Temperature Differential" between iron tip and the

components and the PCB), should be within the conditions of table 3.

It is required to keep the temperature differential between the soldering Iron and the component's surface (ΔT) as small as possible.

After soldering, do not allow the component/PCB to cool down rapidly.

The operating time for the re-working should be as short as possible. When re-working time is too long, it may cause solder leaching, in turn causing a reduction of the adhesive strength of the terminations.

Table 3

| Part Number | Temperature of Soldering Iron Tip | Preheating Temperature | Temperature Differential (ΔT) | Atmosphere |
|-------------------|-----------------------------------|------------------------|---|------------|
| G□□18/21/31 | 350°C max. | 150°C min. | $\Delta T \leq 190^\circ\text{C}$ | air |
| G□□32/42/43/52/55 | 280°C max. | 150°C min. | $\Delta T \leq 130^\circ\text{C}$ | air |

*Applicable for both Pb-Sn and Lead Free Solder.
 Pb-Sn Solder: Sn-37Pb
 Lead Free Solder: Sn-3.0Ag-0.5Cu

- Optimum Solder Amount when re-working Using a Soldering Iron

For sizes smaller than G□□18, the top of the solder fillet should be lower than 2/3 of the thickness of the component or 0.5mm whichever is smaller.

For sizes larger than G□□21, the top of the solder fillet should be lower than 2/3 of the thickness of the component.

If the solder amount is excessive, the risk of cracking is higher during board bending or under any other stressful conditions.

A Soldering iron $\phi 3\text{mm}$ or smaller should be used.

It is also necessary to keep the soldering iron from touching the components during the re-work.

Solder wire with $\phi 0.5\text{mm}$ or smaller is required for soldering.

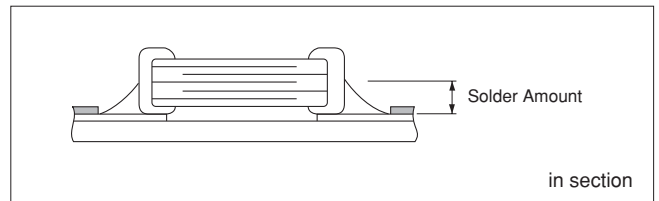

7. Washing

Excessive output of ultrasonic oscillation during cleaning causes PCBs to resonate, resulting in cracked chips or broken solder. Take note not to vibrate PCBs.

8. Handling

Do not directly touch the chip capacitor, especially the ceramic body. Residue from hands/fingers may create a short circuit environment.

FAILURE TO FOLLOW THE ABOVE CAUTIONS MAY RESULT, WORST CASE, IN A SHORT CIRCUIT AND FUMING WHEN THE PRODUCT IS USED.

Notice

Rating

1. Capacitance Change of Capacitor

(1) In the case of X7R, X7T char.

Capacitors have an aging characteristic, whereby the capacitor continually decreases its capacitance slightly if the capacitor is left on for a long time. Moreover, capacitance might change greatly depending on the surrounding temperature or an applied voltage. Therefore, it is not likely to be suitable for use in a time constant circuit. Please contact us if you need detailed information.

(2) In the case of any char. except X7R, X7T

Capacitance might change a little depending on the surrounding temperature or an applied voltage. Please contact us if you intend to use this product in a strict time constant circuit.

2. Performance Check by Equipment

Before using a capacitor, check that there is no problem in the equipment's performance and the specifications.

Generally speaking, CLASS 2 (X7R, X7T char.) ceramic capacitors have voltage dependence characteristics and temperature dependence characteristics in capacitance. Therefore, the capacitance value may change depending on the operating condition in the equipment.

Accordingly, be sure to confirm the apparatus performance of receiving influence in a capacitance value change of a capacitor, such as leakage current and noise suppression characteristics.

Moreover, check the surge-proof ability of a capacitor in the equipment, if needed, because the surge voltage may exceed the specific value by the inductance of the circuit.

Soldering and Mounting

1. Construction of Board Pattern

After installing chips, if solder is excessively applied to the circuit board, mechanical stress will cause destruction resistance characteristics to lower. To prevent this, be extremely careful in determining shape and dimension before designing the circuit board diagram.

Construction and Dimensions of Pattern (Example)

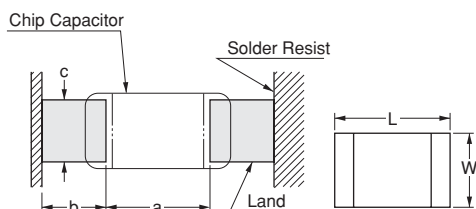

Flow Soldering

| L×W | a | b | c |
|----------|---------|---------|---------|
| 1.6×0.8 | 0.6-1.0 | 0.8-0.9 | 0.6-0.8 |
| 2.0×1.25 | 1.0-1.2 | 0.9-1.0 | 0.8-1.1 |
| 3.2×1.6 | 2.2-2.6 | 1.0-1.1 | 1.0-1.4 |

Flow soldering: 3.2×1.6 or less available.

Reflow Soldering

| L×W | a | b | c |
|----------|---------|---------|---------|
| 1.6×0.8 | 0.6-0.8 | 0.6-0.7 | 0.6-0.8 |
| 2.0×1.25 | 1.0-1.2 | 0.6-0.7 | 0.8-1.1 |
| 3.2×1.6 | 2.2-2.4 | 0.8-0.9 | 1.0-1.4 |
| 3.2×2.5 | 2.0-2.4 | 1.0-1.2 | 1.8-2.3 |
| 4.5×2.0 | 2.8-3.4 | 1.2-1.4 | 1.4-1.8 |
| 4.5×3.2 | 2.8-3.4 | 1.2-1.4 | 2.3-3.0 |
| 5.7×2.8 | 4.0-4.6 | 1.4-1.6 | 2.1-2.6 |
| 5.7×5.0 | 4.0-4.6 | 1.4-1.6 | 3.5-4.8 |

(in mm)

Continued on the following page. ↗

For General Purpose
GRM/GRJ/GR3 Series

Only for Applications

AC250V Type
GA2 Series

Safety Standard
Certified GA3 Series

Product Information
Notice

Notice

☐ Continued from the preceding page.

Dimensions of Slit (Example)

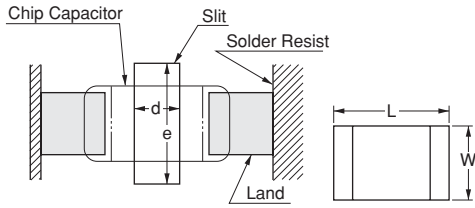

| L×W | d | e |
|----------|---------|---------|
| 1.6×0.8 | - | - |
| 2.0×1.25 | - | - |
| 3.2×1.6 | 1.0-2.0 | 3.2-3.7 |
| 3.2×2.5 | 1.0-2.0 | 4.1-4.6 |
| 4.5×2.0 | 1.0-2.8 | 3.6-4.1 |
| 4.5×3.2 | 1.0-2.8 | 4.8-5.3 |
| 5.7×2.8 | 1.0-4.0 | 4.4-4.9 |
| 5.7×5.0 | 1.0-4.0 | 6.6-7.1 |

(in mm)

Preparing the slit helps flux cleaning and resin coating on the back of the capacitor.

However, the length of the slit design should be as short as possible to prevent mechanical damage in the capacitor.

A longer slit design might receive more severe mechanical stress from the PCB.

Recommended slit design is shown in the Table.

Land Layout to Prevent Excessive Solder

| | Mounting Close to a Chassis | Mounting with Leaded Components | Mounting Leaded Components Later |
|---|-----------------------------|---------------------------------|----------------------------------|
| Examples to Be Avoided | | | |
| Examples of Improvements by the Land Division | | | |

2. Mounting of Chips

- Thickness of adhesives applied
 Keep thickness of adhesives applied (50-105μm or more) to reinforce the adhesive contact considering the thickness of the termination or capacitor (20-70μm) and the land pattern (30-35μm).
- Mechanical shock of the chip placer
 When the positioning claws and pick-up nozzle are worn, the load is applied to the chip while positioning is concentrated in one position, thus causing cracks, breakage, faulty positioning accuracy, etc.
 Careful checking and maintenance are necessary to prevent unexpected trouble.
 An excessively low bottom dead point of the suction nozzle imposes great force on the chip during mounting, causing cracked chips. Please set the suction nozzle's bottom dead point on the upper surface of the board.

Continued on the following page. ☐

For General Purpose GRM/GRU/GR3 Series
 Only for Applications
 AC250V Type GA2 Series
 Safety Standard Certified GA3 Series
 Product Information Notice

Notice

☐ Continued from the preceding page.

3. Soldering

(1) Limit of losing effective area of the terminations and conditions needed for soldering.

Depending on the conditions of the soldering temperature and/or immersion (melting time), effective areas may be lost in some parts of the terminations.

To prevent this, be careful in soldering so that any possible loss of the effective area on the terminations will securely remain at a maximum of 25% on all edge length A-B-C-D-A of part with A, B, C, D, shown in the Figure below.

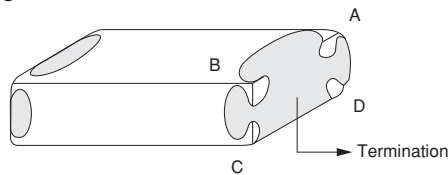

4. Cleaning

Please confirm there is no problem in the reliability of the product beforehand when cleaning it with the intended equipment.

The residue after cleaning it might cause a decrease in the surface resistance of the chip and the corrosion of the electrode part, etc. As a result it might cause reliability to deteriorate. Please confirm beforehand that there is no problem with the intended equipment in ultrasonic cleansing.

5. Resin Coating

Please use it after confirming there is no influence on the product with the intended equipment before the resin coating and molding.

A cracked chip might be caused at the cooling/heating cycle by the amount of resin spreading and/or bias thickness.

The resin for coating and molding must be selected as the stress is small when stiffening and the hygroscopic is low as possible.

(2) Flux Application

- An excessive amount of flux generates a large quantity of flux gas, causing deteriorated solderability. So apply flux thinly and evenly throughout. (A foaming system is generally used for flow soldering.)
- Flux containing too high a percentage of halide may cause corrosion of the outer electrodes without sufficient cleaning. Use flux with a halide content of 0.2% max.
- Do not use strong acidic flux.
- Do not use water-soluble flux.*
(*Water-soluble flux can be defined as non rosin type flux including wash-type flux and non-wash-type flux.)

(3) Solder

The use of Sn-Zn based solder will deteriorate the reliability of the MLCC.

Please contact our sales representative or product engineers on the use of Sn-Zn based solder in advance.

For General Purpose
GRW/GRJ/GR3 Series

Only for Applications

AC250V Type
GA2 Series

Safety Standard
Certified GA3 Series

Product Information
Notice

MEMO

Contents

Metal Terminal Monolithic Ceramic Capacitors

For General Purpose KRM/KR3 Series

| | |
|--|------|
| High Capacitance for General Use KRM Series | p200 |
| Large Capacitance and High Allowable Ripple Current Type KR3 Series | p204 |
| <hr/> | |
| Package | p208 |
| ⚠Caution/Notice | p210 |

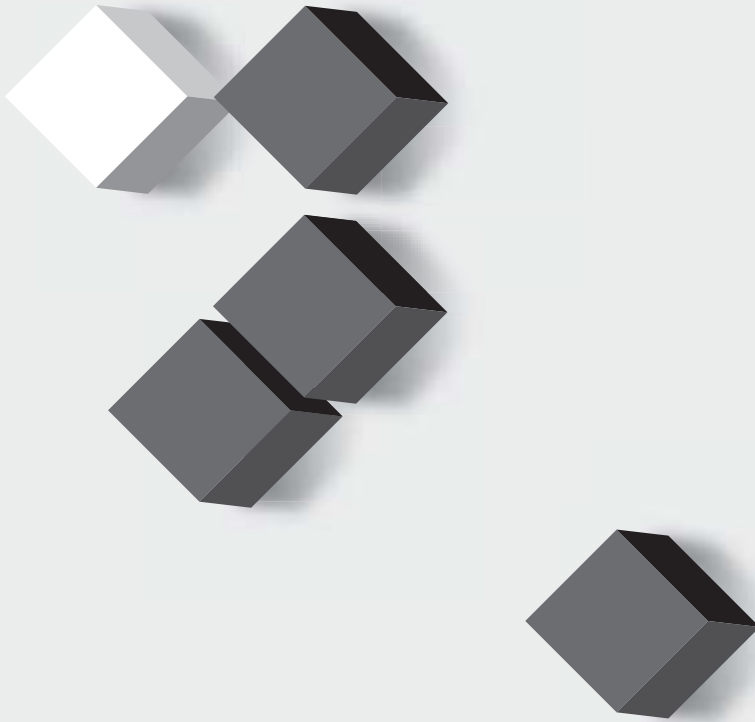

For General Purpose
KRM/KR3 Series

Product Information

Metal Terminal Monolithic Ceramic Capacitors

High Capacitance for General Use KRM Series

Anti-noise

Deflecting crack

Soldering crack

■ Features

1. The product has high reliability against heat and mechanical impact.
2. Stacking two capacitors reduces the mounting space and achieves a large capacitance.
3. The unique terminal structure greatly reduces noise from the ceramics on the board.

■ Applications

For smoothing and noise suppression of DC-DC converters

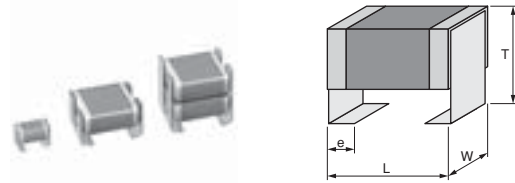

| Part Number | Dimensions (mm) | | | e |
|-------------|-----------------|----------|---------|---------|
| | L | W | T | |
| KRM31F | 3.5±0.3 | 1.7±0.2 | 1.9±0.1 | 0.8±0.2 |
| | 3.5±0.3 | 1.7±0.2 | 2.7±0.2 | |
| | 3.6±0.3 | 1.7±0.2 | 2.7±0.2 | |
| KRM31K | 3.7±0.3 | 1.85±0.2 | 2.7±0.2 | 0.8±0.2 |
| | 3.7±0.3 | 1.85±0.2 | 2.7±0.2 | |
| KRM55L | 6.1±0.4 | 5.3±0.2 | 2.8±0.2 | 1.2±0.2 |
| KRM55Q | | | 3.7±0.2 | |
| KRM55T | | | 4.8±0.2 | |
| KRM55W | | | 6.4±0.3 | |
| | | | 6.4±0.3 | |

Do not use these products in any Automotive Power train or Safety equipment including Battery chargers for Electric Vehicles and Plug-in Hybrids. Only Murata products clearly stipulated as "for Automotive use" can be used for automobile applications such as Power train and Safety equipment.

| Part Number | Rated Voltage | TC Code (Standard) | Capacitance | Length L (mm) | Width W (mm) | Thickness T max. (mm) | Metal Terminal Width e (mm) |
|--------------------|---------------|--------------------|-------------|---------------|--------------|-----------------------|-----------------------------|
| KRM31FR61E106KH01K | 25Vdc | X5R (EIA) | 10μF±10% | 3.5 | 1.7 | 2 | 0.8±0.2mm |
| KRM31KC81E106KH01K | 25Vdc | X6S (EIA) | 10μF±10% | 3.5 | 1.7 | 2.9 | 0.8±0.2mm |
| KRM55LR71E156KH01K | 25Vdc | X7R (EIA) | 15μF±10% | 6.1 | 5.3 | 3 | 1.2±0.2mm |
| KRM55QR71E226KH01K | 25Vdc | X7R (EIA) | 22μF±10% | 6.1 | 5.3 | 3.9 | 1.2±0.2mm |
| KRM55TR71E336MH01K | 25Vdc | X7R (EIA) | 33μF±20% | 6.1 | 5.3 | 5 | 1.2±0.2mm |
| KRM55WR71E476MH01K | 25Vdc | X7R (EIA) | 47μF±20% | 6.1 | 5.3 | 6.7 | 1.2±0.2mm |
| KRM31KR71H225KH01K | 50Vdc | X7R (EIA) | 2.2μF±10% | 3.6 | 1.7 | 2.9 | 0.8±0.2mm |
| KRM31KR71H475KH01K | 50Vdc | X7R (EIA) | 4.7μF±10% | 3.5 | 1.7 | 2.9 | 0.8±0.2mm |
| KRM55LR71H475KH01K | 50Vdc | X7R (EIA) | 4.7μF±10% | 6.1 | 5.3 | 3 | 1.2±0.2mm |
| KRM55QR71H106KH01K | 50Vdc | X7R (EIA) | 10μF±10% | 6.1 | 5.3 | 3.9 | 1.2±0.2mm |
| KRM55WR71H226MH01K | 50Vdc | X7R (EIA) | 22μF±20% | 6.1 | 5.3 | 6.7 | 1.2±0.2mm |
| KRM55LR71J475KH01K | 63Vdc | X7R (EIA) | 4.7μF±10% | 6.1 | 5.3 | 3 | 1.2±0.2mm |
| KRM55QR71J106KH01K | 63Vdc | X7R (EIA) | 10μF±10% | 6.1 | 5.3 | 3.9 | 1.2±0.2mm |
| KRM55WR71J226MH01K | 63Vdc | X7R (EIA) | 22μF±20% | 6.1 | 5.3 | 6.7 | 1.2±0.2mm |
| KRM31KR72A105KH01K | 100Vdc | X7R (EIA) | 1.0μF±10% | 3.5 | 1.7 | 2.9 | 0.8±0.2mm |
| KRM31KR72A225KH01K | 100Vdc | X7R (EIA) | 2.2μF±10% | 3.7 | 1.7 | 2.9 | 0.8±0.2mm |
| KRM55LR72A475KH01K | 100Vdc | X7R (EIA) | 4.7μF±10% | 6.1 | 5.3 | 3 | 1.2±0.2mm |
| KRM55QR72A685KH01K | 100Vdc | X7R (EIA) | 6.8μF±10% | 6.1 | 5.3 | 3.9 | 1.2±0.2mm |
| KRM55TR72A106MH01K | 100Vdc | X7R (EIA) | 10μF±20% | 6.1 | 5.3 | 5 | 1.2±0.2mm |
| KRM55WR72A156MH01K | 100Vdc | X7R (EIA) | 15μF±20% | 6.1 | 5.3 | 6.7 | 1.2±0.2mm |

KRM Series Specifications and Test Methods

| No. | Item | Specifications | Test Method | | | | | | | | | | | | |
|---------------------|---|--|--|---------------------|---------------------|---------------------|---------------------------|----------|---------------------------|--------|----------|--------------------|-------------------------|---|------|
| 1 | Operating Temperature Range | X5R Char.: -55 to +85°C X6S Char.: -55 to +105°C X7R Char.: -55 to +125°C | Reference temperature: 25°C | | | | | | | | | | | | |
| 2 | Appearance | No defects or abnormalities | Visual inspection | | | | | | | | | | | | |
| 3 | Dimensions | Within the specified dimensions | Using calipers and micrometers | | | | | | | | | | | | |
| 4 | Dielectric Strength | No defects or abnormalities | No failure should be observed when voltage in the table is applied between the terminations for 1 to 5 sec., provided the charge/discharge current is less than 50mA. <table border="1" style="margin: 10px auto; border-collapse: collapse;"> <thead> <tr style="background-color: #f2f2f2;"> <th>Rated Voltage</th> <th>Test Voltage</th> </tr> </thead> <tbody> <tr> <td>DC25V, DC50V, DC63V</td> <td>250% of the rated voltage</td> </tr> <tr> <td>DC100V</td> <td>200% of the rated voltage</td> </tr> </tbody> </table> | Rated Voltage | Test Voltage | DC25V, DC50V, DC63V | 250% of the rated voltage | DC100V | 200% of the rated voltage | | | | | | |
| Rated Voltage | Test Voltage | | | | | | | | | | | | | | |
| DC25V, DC50V, DC63V | 250% of the rated voltage | | | | | | | | | | | | | | |
| DC100V | 200% of the rated voltage | | | | | | | | | | | | | | |
| 5 | Insulation Resistance (I.R.) | [KRM31] W.V.: 25V : More than 50MΩ · μF W.V.: 50V/100V : More than 500MΩ · μF [KRM55] More than 100MΩ · μF | The insulation resistance should be measured with Rated Voltage and within 60±5 sec. of charging. | | | | | | | | | | | | |
| 6 | Capacitance | Within the specified tolerance | The capacitance/D.F. should be measured at reference temperature at the meaning frequency and voltage shown in the table. <table border="1" style="margin: 10px auto; border-collapse: collapse;"> <thead> <tr style="background-color: #f2f2f2;"> <th>Nominal Capacitance</th> <th>Measuring Frequency</th> <th>Measuring Voltage</th> </tr> </thead> <tbody> <tr> <td>C>10μF</td> <td>120±24Hz</td> <td>AC0.5±0.1V(r.m.s.)</td> </tr> <tr> <td>C≤10μF</td> <td>1±0.2kHz</td> <td>AC1.0±0.2V(r.m.s.)</td> </tr> </tbody> </table> | Nominal Capacitance | Measuring Frequency | Measuring Voltage | C>10μF | 120±24Hz | AC0.5±0.1V(r.m.s.) | C≤10μF | 1±0.2kHz | AC1.0±0.2V(r.m.s.) | | | |
| Nominal Capacitance | Measuring Frequency | Measuring Voltage | | | | | | | | | | | | | |
| C>10μF | 120±24Hz | AC0.5±0.1V(r.m.s.) | | | | | | | | | | | | | |
| C≤10μF | 1±0.2kHz | AC1.0±0.2V(r.m.s.) | | | | | | | | | | | | | |
| 7 | Dissipation Factor (D.F.) | [KRM31] W.V.: 25V : 0.15 max. W.V.: 50V : 0.025 max. W.V.: 100V : 0.05 max. [KRM55] 0.025 max. | | | | | | | | | | | | | |
| 8 | Capacitance Temperature Characteristics | X5R Char.: Within ±15% (Temp. Range: -55 to +85°C) X6S Char.: Within ±22% (Temp. Range: -55 to +105°C) X7R Char.: Within ±15% (Temp. Range: -55 to +125°C) | The capacitance measurement should be made at each step specified in the Table. <table border="1" style="margin: 10px auto; border-collapse: collapse;"> <thead> <tr style="background-color: #f2f2f2;"> <th>Step</th> <th>Temperature (°C)</th> </tr> </thead> <tbody> <tr> <td style="text-align: center;">1</td> <td style="text-align: center;">25±2</td> </tr> <tr> <td style="text-align: center;">2</td> <td style="text-align: center;">Min. Operating Temp. ±3</td> </tr> <tr> <td style="text-align: center;">3</td> <td style="text-align: center;">25±2</td> </tr> <tr> <td style="text-align: center;">4</td> <td style="text-align: center;">Max. Operating Temp. ±2</td> </tr> <tr> <td style="text-align: center;">5</td> <td style="text-align: center;">25±2</td> </tr> </tbody> </table> <p>•Pretreatment Perform a heat treatment at 150+0/-10°C for 60±5 min. and then let sit for 24±2 hrs. at room condition. (*1)</p> | Step | Temperature (°C) | 1 | 25±2 | 2 | Min. Operating Temp. ±3 | 3 | 25±2 | 4 | Max. Operating Temp. ±2 | 5 | 25±2 |
| Step | Temperature (°C) | | | | | | | | | | | | | | |
| 1 | 25±2 | | | | | | | | | | | | | | |
| 2 | Min. Operating Temp. ±3 | | | | | | | | | | | | | | |
| 3 | 25±2 | | | | | | | | | | | | | | |
| 4 | Max. Operating Temp. ±2 | | | | | | | | | | | | | | |
| 5 | 25±2 | | | | | | | | | | | | | | |
| 9 | Strength of Metal Terminal | Termination not to be broken or loosened | A static load of 10N using a pressure rod should be applied to the center in the direction of the arrow and held for 10 s. <div style="text-align: center; margin-top: 10px;"> </div> | | | | | | | | | | | | |
| 10 | Adhesive Strength of Termination | No removal of the terminations or other defect should occur. | Solder the capacitor to the testing jig (glass epoxy board) shown in Fig. 1. Then apply 10N force in the direction of the arrow. The soldering should be done using the reflow method and should be conducted with care so that the soldering is uniform and free defects such as heat shock. <div style="text-align: center; margin-top: 10px;"> </div> <p style="text-align: center;">Fig. 1</p> | | | | | | | | | | | | |

(*1) "Room condition" Temperature: 15 to 35°C, Relative humidity: 45 to 75%, Atmospheric pressure: 86 to 106kPa

Continued on the following page.

For General Purpose KRM/KR3 Series

Product Information

KRM Series Specifications and Test Methods

Continued from the preceding page.

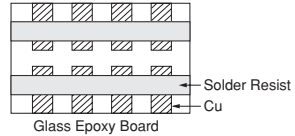
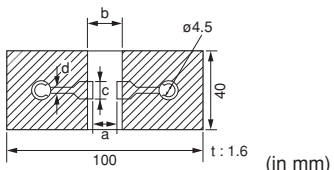
| No. | Item | Specifications | Test Method | | | | | | | | | | | | | | | | | |
|-------|------------------------------|---|--|-------------|----------------|--|--|--|---|---|---|---|-------|-----|-----|------|-----|-------|-----|-----|
| 11 | Appearance | No defects or abnormalities | Solder the capacitor to the test jig (glass epoxy board). The capacitor should be subjected to a simple harmonic motion having a total amplitude of 1.5mm, the frequency being varied uniformly between the approximate limits of 10 and 55Hz. The frequency range, from 10 to 55Hz and return to 10Hz, should be traversed in approximately 1 min. This motion should be applied for a period of 2 hrs. in each of 3 mutually perpendicular directions (total of 6 hrs.). | | | | | | | | | | | | | | | | | |
| | Capacitance | Within the specified tolerance | | | | | | | | | | | | | | | | | | |
| 12 | Vibration Resistance | D.F. In accordance with item No.7 |  | | | | | | | | | | | | | | | | | |
| | Deflection | No marking defects  <table border="1" data-bbox="367 884 877 985"> <thead> <tr> <th rowspan="2">Type</th> <th colspan="4">Dimension (mm)</th> </tr> <tr> <th>a</th> <th>b</th> <th>c</th> <th>d</th> </tr> </thead> <tbody> <tr> <td>KRM31</td> <td>2.2</td> <td>5.0</td> <td>1.65</td> <td>1.0</td> </tr> <tr> <td>KRM55</td> <td>4.5</td> <td>8.0</td> <td>5.6</td> <td>1.0</td> </tr> </tbody> </table> | | Type | Dimension (mm) | | | | a | b | c | d | KRM31 | 2.2 | 5.0 | 1.65 | 1.0 | KRM55 | 4.5 | 8.0 |
| Type | Dimension (mm) | | | | | | | | | | | | | | | | | | | |
| | a | b | c | d | | | | | | | | | | | | | | | | |
| KRM31 | 2.2 | 5.0 | 1.65 | 1.0 | | | | | | | | | | | | | | | | |
| KRM55 | 4.5 | 8.0 | 5.6 | 1.0 | | | | | | | | | | | | | | | | |
| 13 | Solderability of Termination | The metal surface is soldered well | Reflow Soldering: Peak 260+0/-5°C The area of soldering 230°C min., 20 to 40 s Let sit for 24±2 h at room condition,* then measure. | | | | | | | | | | | | | | | | | |
| | | | •Pretreatment Perform the heat treatment at 150+0/-10°C for 60±5 min. and then let sit for 24±2 h at room condition. (*1) | | | | | | | | | | | | | | | | | |
| 14 | Appearance | No marking defects | •In case of Reflow Soldering See item 13 Solderability of termination •In case of Soldering Iron Temp. of solder: 350±10°C Solder time: 4+1/-0 s Let sit for 24±2 hrs.at room condition,* then measure Please refer to "Caution (Soldering and Mounting) Correction with a Soldering Iron" | | | | | | | | | | | | | | | | | |
| | Resistance to Soldering Heat | Capacitance Change | | Within ±10% | | | | | | | | | | | | | | | | |
| | D.F. | In accordance with item No.7 | | | | | | | | | | | | | | | | | | |
| | I.R. | In accordance with item No.5 | | | | | | | | | | | | | | | | | | |
| | Dielectric Strength | In accordance with item No.4 | | | | | | | | | | | | | | | | | | |

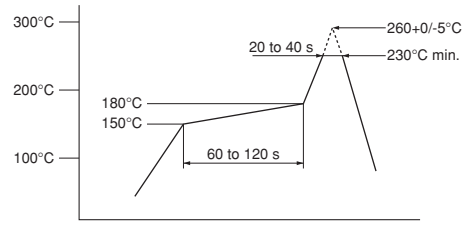
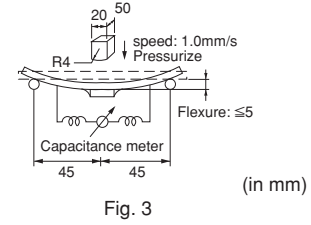

(*1) "Room condition" Temperature: 15 to 35°C, Relative humidity: 45 to 75%, Atmospheric pressure: 86 to 106kPa

Continued on the following page. ➤

For General Purpose KRM/KR3 Series Product Information

KRM Series Specifications and Test Methods

Continued from the preceding page.

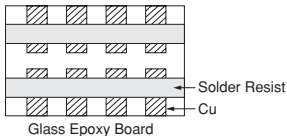
| No. | Item | Specifications | Test Method | | | | | | | | | | | | | | | | |
|---------------------|--|------------------------------|--|--|---------------|------------------|--------------|--------------------------------|-------------------------|---------------------------|---|------------|--------|---|-------------------------|------|---|------------|--------|
| 15 | Temperature Cycle | Appearance | No marking defects | Fix the capacitor to the supporting jig (glass epoxy board) shown in Fig. 4. Perform the 100 cycles according to the 4 heat treatments listed in the following table. Let sit for 24±2 hrs. at room condition,* then measure. <table border="1" style="margin: 10px 0; width: 100%; border-collapse: collapse;"> <thead> <tr style="background-color: #f2f2f2;"> <th>Step</th> <th>Temperature (°C)</th> <th>Time (min.)</th> </tr> </thead> <tbody> <tr> <td>1</td> <td>Min. Operating Temp. ±3</td> <td>30±3</td> </tr> <tr> <td>2</td> <td>Room Temp.</td> <td>2 to 3</td> </tr> <tr> <td>3</td> <td>Max. Operating Temp. ±2</td> <td>30±3</td> </tr> <tr> <td>4</td> <td>Room Temp.</td> <td>2 to 3</td> </tr> </tbody> </table> | Step | Temperature (°C) | Time (min.) | 1 | Min. Operating Temp. ±3 | 30±3 | 2 | Room Temp. | 2 to 3 | 3 | Max. Operating Temp. ±2 | 30±3 | 4 | Room Temp. | 2 to 3 |
| | | Step | Temperature (°C) | | Time (min.) | | | | | | | | | | | | | | |
| | | 1 | Min. Operating Temp. ±3 | | 30±3 | | | | | | | | | | | | | | |
| | | 2 | Room Temp. | | 2 to 3 | | | | | | | | | | | | | | |
| | | 3 | Max. Operating Temp. ±2 | | 30±3 | | | | | | | | | | | | | | |
| 4 | Room Temp. | 2 to 3 | | | | | | | | | | | | | | | | | |
| Capacitance Change | Within ±7.5% | | | | | | | | | | | | | | | | | | |
| D.F. | In accordance with item No.7 | | | | | | | | | | | | | | | | | | |
| I.R. | In accordance with item No.5 | | | | | | | | | | | | | | | | | | |
| | Dielectric Strength | In accordance with item No.4 | | | | | | | | | | | | | | | | | |
| 16 | Humidity (Steady State) | Appearance | No marking defects | Let the capacitor sit at 40±2°C and relative humidity of 90 to 95% for 500+24/-0 hrs. Remove and let sit for 24±2 hrs. at room condition,* then measure. •Pretreatment Perform a heat treatment at 150+0/-10°C for 60±5 min. and then let sit for 24±2 hrs. at room condition. (*1) <div style="text-align: center; margin: 10px 0;">  <p style="font-size: small;">Solder Resist Cu Glass Epoxy Board</p> </div> <p style="text-align: center; margin: 0;">Fig. 4</p> | | | | | | | | | | | | | | | |
| | | Capacitance Change | Within ±15% | | | | | | | | | | | | | | | | |
| | | D.F. | [KRM31] W.V.: 25V : 0.2 max. W.V.: 50V/100V : 0.05 max. [KRM55] 0.05 max. | | | | | | | | | | | | | | | | |
| | | I.R. | [KRM31] W.V.: 25V : More than 12.5MΩ · μF W.V.: 50V/100V : More than 50MΩ · μF [KRM55] More than 10MΩ · μF | | | | | | | | | | | | | | | | |
| | | Dielectric Strength | In accordance with item No.4 | | | | | | | | | | | | | | | | |
| 17 | Life | Appearance | No marking defects | Apply voltage as in the Table for 1000+48/-0 hrs. at maximum operating temperature ±3°C. Remove and let sit for 24±2 hrs. at room condition, (*1) then measure. <table border="1" style="margin: 10px 0; width: 100%; border-collapse: collapse;"> <thead> <tr style="background-color: #f2f2f2;"> <th>Rated Voltage</th> <th>Applied Voltage</th> </tr> </thead> <tbody> <tr> <td>DC25V, DC50V</td> <td>200% of the rated voltage (*2)</td> </tr> <tr> <td>DC63V, DC100V</td> <td>150% of the rated voltage</td> </tr> </tbody> </table> | Rated Voltage | Applied Voltage | DC25V, DC50V | 200% of the rated voltage (*2) | DC63V, DC100V | 150% of the rated voltage | | | | | | | | | |
| | | Rated Voltage | Applied Voltage | | | | | | | | | | | | | | | | |
| | | DC25V, DC50V | 200% of the rated voltage (*2) | | | | | | | | | | | | | | | | |
| | | DC63V, DC100V | 150% of the rated voltage | | | | | | | | | | | | | | | | |
| | | Capacitance Change | Within ±15% | | | | | | | | | | | | | | | | |
| D.F. | [KRM31] W.V.: 25V : 0.2 max. W.V.: 50V/100V : 0.05 max. [KRM55] 0.05 max. | | | | | | | | | | | | | | | | | | |
| I.R. | [KRM31] W.V.: 25V : More than 25MΩ · μF W.V.: 50V/100V : More than 50MΩ · μF [KRM55] More than 10MΩ · μF | | | | | | | | | | | | | | | | | | |
| Dielectric Strength | In accordance with item No.4 | | | | | | | | | | | | | | | | | | |

(*1) "Room condition" Temperature: 15 to 35°C, Relative humidity: 45 to 75%, Atmospheric pressure: 86 to 106kPa

Metal Terminal Monolithic Ceramic Capacitors

Large Capacitance and High Allowable Ripple Current KR3 Series

Anti-noise

Deflecting crack

Soldering crack

■ Features

1. The product has high reliability against heat and mechanical impact.
2. Stacking two capacitors reduces the mounting space and achieves a large capacitance.
3. The unique terminal structure greatly reduces noise from the ceramics on the board.
4. This series can provide higher capacitance value under DC-Bias condition, compare with previous X7R char.
5. Improve the performance of ripple-resistance compared with X7R char.

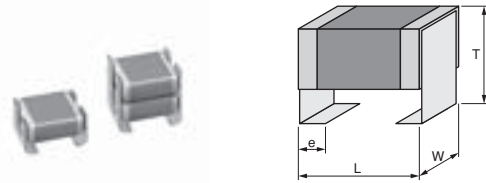

| Part Number | Dimensions (mm) | | | |
|-------------|-----------------|---------|---------|---------|
| | L | W | T | e |
| KR355L | 6.1±0.4 | 5.3±0.2 | 2.8±0.2 | 1.2±0.2 |
| KR355Q | | | 3.7±0.2 | |
| KR355T | | | 4.8±0.2 | |
| KR355W | | | 6.4±0.3 | |

■ Applications

1. DC smoothing & EMI filter for LED Lighting.
2. For PFC circuit in the switching power supplies, AC adaptor.
3. DC-DC converter for general electronic equipment.

Do not use these products in any Automotive Power train or Safety equipment including Battery chargers for Electric Vehicles and Plug-in Hybrids. Only Murata products clearly stipulated as "for Automotive use" can be used for automobile applications such as Power train and Safety equipment.

| Part Number | Rated Voltage | TC Code (Standard) | Capacitance | Length L (mm) | Width W (mm) | Thickness T max. (mm) | Metal Terminal Width e (mm) |
|--------------------|---------------|--------------------|-------------|---------------|--------------|-----------------------|-----------------------------|
| KR355LD72E474KH01K | 250Vdc | X7T (EIA) | 0.47µF±10% | 6.1 | 5.3 | 3 | 1.2±0.2mm |
| KR355QD72E105KH01K | 250Vdc | X7T (EIA) | 1.0µF±10% | 6.1 | 5.3 | 3.9 | 1.2±0.2mm |
| KR355WD72E225MH01K | 250Vdc | X7T (EIA) | 2.2µF±20% | 6.1 | 5.3 | 6.7 | 1.2±0.2mm |
| KR355LD72W224KH01K | 450Vdc | X7T (EIA) | 0.22µF±10% | 6.1 | 5.3 | 3 | 1.2±0.2mm |
| KR355LD72W474KH01K | 450Vdc | X7T (EIA) | 0.47µF±10% | 6.1 | 5.3 | 3 | 1.2±0.2mm |
| KR355QD72W564KH01K | 450Vdc | X7T (EIA) | 0.56µF±10% | 6.1 | 5.3 | 3.9 | 1.2±0.2mm |
| KR355TD72W105MH01K | 450Vdc | X7T (EIA) | 1.0µF±20% | 6.1 | 5.3 | 5 | 1.2±0.2mm |
| KR355WD72W125MH01K | 450Vdc | X7T (EIA) | 1.2µF±20% | 6.1 | 5.3 | 6.7 | 1.2±0.2mm |
| KR355LD72J104KH01K | 630Vdc | X7T (EIA) | 0.1µF±10% | 6.1 | 5.3 | 3 | 1.2±0.2mm |
| KR355LD72J154KH01K | 630Vdc | X7T (EIA) | 0.15µF±10% | 6.1 | 5.3 | 3 | 1.2±0.2mm |
| KR355QD72J224KH01K | 630Vdc | X7T (EIA) | 0.22µF±10% | 6.1 | 5.3 | 3.9 | 1.2±0.2mm |
| KR355QD72J274KH01K | 630Vdc | X7T (EIA) | 0.27µF±10% | 6.1 | 5.3 | 3.9 | 1.2±0.2mm |
| KR355WD72J474MH01K | 630Vdc | X7T (EIA) | 0.47µF±20% | 6.1 | 5.3 | 6.7 | 1.2±0.2mm |
| KR355WD72J564MH01K | 630Vdc | X7T (EIA) | 0.56µF±20% | 6.1 | 5.3 | 6.7 | 1.2±0.2mm |

KR3 Series Specifications and Test Methods

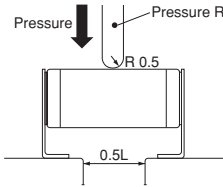
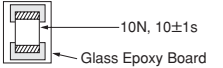
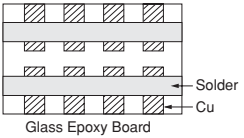
| No. | Item | Specifications | Test Method | | | | | | | | | | | | |
|---------------|---|--|---|---------------|------------------|--------|---------------------------|--------|---------------------------|--------|---------------------------|---|-------------------------|---|------|
| 1 | Operating Temperature Range | -55 to +125°C | Reference temperature: 25°C | | | | | | | | | | | | |
| 2 | Appearance | No defects or abnormalities | Visual inspection | | | | | | | | | | | | |
| 3 | Dimensions | Within the specified dimensions | Using calipers and micrometers | | | | | | | | | | | | |
| 4 | Dielectric Strength | No defects or abnormalities | <p>No failure should be observed when voltage in the table is applied between the terminations for 1 to 5 sec., provided the charge/discharge current is less than 50mA.</p> <table border="1" style="margin-left: auto; margin-right: auto;"> <thead> <tr> <th>Rated Voltage</th> <th>Test Voltage</th> </tr> </thead> <tbody> <tr> <td>DC250V</td> <td>200% of the rated voltage</td> </tr> <tr> <td>DC450V</td> <td>150% of the rated voltage</td> </tr> <tr> <td>DC630V</td> <td>120% of the rated voltage</td> </tr> </tbody> </table> | Rated Voltage | Test Voltage | DC250V | 200% of the rated voltage | DC450V | 150% of the rated voltage | DC630V | 120% of the rated voltage | | | | |
| Rated Voltage | Test Voltage | | | | | | | | | | | | | | |
| DC250V | 200% of the rated voltage | | | | | | | | | | | | | | |
| DC450V | 150% of the rated voltage | | | | | | | | | | | | | | |
| DC630V | 120% of the rated voltage | | | | | | | | | | | | | | |
| 5 | Insulation Resistance (I.R.) | More than 10,000MΩ or 100Ω · μF (Whichever is Smaller) | The insulation resistance should be measured with DC500V±50V (DC250V±25V in case of rated Voltage: DC250V, DC450V) and within 60±5 sec. of charging. | | | | | | | | | | | | |
| 6 | Capacitance | Within the specified tolerance | The capacitance/D.F. should be measured at a frequency of 1±0.2kHz and a voltage of AC1±0.2V (r.m.s.). | | | | | | | | | | | | |
| 7 | Dissipation Factor (D.F.) | 0.01 max. | | | | | | | | | | | | | |
| 8 | Capacitance Temperature Characteristics | Cap. Change Within +22/-33% (Temp. Range: -55 to +125°C) | <p>The capacitance measurement should be made at each step specified in the table.</p> <table border="1" style="margin-left: auto; margin-right: auto;"> <thead> <tr> <th>Step</th> <th>Temperature (°C)</th> </tr> </thead> <tbody> <tr> <td>1</td> <td>25±2</td> </tr> <tr> <td>2</td> <td>Min. Operating Temp. ±3</td> </tr> <tr> <td>3</td> <td>25±2</td> </tr> <tr> <td>4</td> <td>Max. Operating Temp. ±2</td> </tr> <tr> <td>5</td> <td>25±2</td> </tr> </tbody> </table> <p>•Pretreatment Perform a heat treatment at 150+0/-10°C for 60±5 min. and then let sit for 24±2 hrs. at room condition.*</p> | Step | Temperature (°C) | 1 | 25±2 | 2 | Min. Operating Temp. ±3 | 3 | 25±2 | 4 | Max. Operating Temp. ±2 | 5 | 25±2 |
| Step | Temperature (°C) | | | | | | | | | | | | | | |
| 1 | 25±2 | | | | | | | | | | | | | | |
| 2 | Min. Operating Temp. ±3 | | | | | | | | | | | | | | |
| 3 | 25±2 | | | | | | | | | | | | | | |
| 4 | Max. Operating Temp. ±2 | | | | | | | | | | | | | | |
| 5 | 25±2 | | | | | | | | | | | | | | |
| 9 | Strength of Metal Terminal | Termination not to be broken or loosened | <p>A static load of 10N using a pressure rod should be applied to the center in the direction of the arrow and held for 10 sec.</p>  | | | | | | | | | | | | |
| 10 | Adhesive Strength of Termination | No removal of the terminations or other defect should occur. | <p>Solder the capacitor to the testing jig (glass epoxy board) shown in Fig. 1. Then apply 10N force in the direction of the arrow. The soldering should be done using the reflow method and should be conducted with care so that the soldering is uniform and free defects such as heat shock.</p>  <p style="text-align: center;">Fig. 1</p> | | | | | | | | | | | | |
| 11 | Appearance | No defects or abnormalities | <p>Solder the capacitor to the test jig (glass epoxy board). The capacitor should be subjected to a simple harmonic motion having a total amplitude of 1.5mm, the frequency being varied uniformly between the approximate limits of 10 and 55Hz. The frequency range, from 10 to 55Hz and return to 10Hz, should be traversed in approximately 1 min. This motion should be applied for a period of 2 hrs. in each of 3 mutually perpendicular directions (total of 6 hrs.).</p>  | | | | | | | | | | | | |
| | Capacitance | Within the specified tolerance | | | | | | | | | | | | | |
| | D.F. | In accordance with item No.7 | | | | | | | | | | | | | |

* "Room condition" Temperature: 15 to 35°C, Relative humidity: 45 to 75%, Atmospheric pressure: 86 to 106kPa

Continued on the following page.

For General Purpose KRM/KR3 Series
 Product Information

KR3 Series Specifications and Test Methods

Continued from the preceding page.

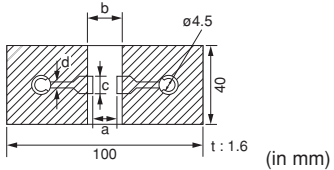
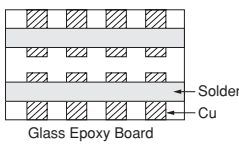
| No. | Item | Specifications | Test Method | | | | | | | | | | | | | | | |
|-------|------------------------------|---|--|------|------------------|-------------|---|-------------------------|------|---|------------|--------|---|-------------------------|------|-----|------------|--------|
| 12 | Deflection | No marking defects | Solder the capacitor to the testing jig (glass epoxy board) shown in Fig. 2. Then apply a force in the direction shown in Fig. 3. The soldering should be done using the reflow method and should be conducted with care so that the soldering is uniform and free of defects such as heat shock. | | | | | | | | | | | | | | | |
| | |  <table border="1" data-bbox="367 548 877 627"> <thead> <tr> <th>Type</th> <th colspan="4">Dimension (mm)</th> </tr> <tr> <th></th> <th>a</th> <th>b</th> <th>c</th> <th>d</th> </tr> </thead> <tbody> <tr> <td>KR355</td> <td>4.5</td> <td>8.0</td> <td>5.6</td> <td>1.0</td> </tr> </tbody> </table> <p style="text-align: center;">Fig. 2</p> | | Type | Dimension (mm) | | | | | a | b | c | d | KR355 | 4.5 | 8.0 | 5.6 | 1.0 |
| Type | Dimension (mm) | | | | | | | | | | | | | | | | | |
| | a | b | c | d | | | | | | | | | | | | | | |
| KR355 | 4.5 | 8.0 | 5.6 | 1.0 | | | | | | | | | | | | | | |
| 13 | Solderability of Termination | The metal surface is soldered well. | Reflow Soldering: Peak 260+0/-5°C The area of soldering 230°C min., 20 to 40 sec. Let sit for 24±2 hrs. at room condition*, then measure. •Pretreatment Perform the heat treatment at 150+0/-10°C for 60±5 min. and then let sit for 24±2 hrs. at room condition.* | | | | | | | | | | | | | | | |
| 14 | Resistance to Soldering Heat | Appearance | No marking defects | | | | | | | | | | | | | | | |
| | | Capacitance Change | Within ±10% | | | | | | | | | | | | | | | |
| | | D.F. | In accordance with item No.7 | | | | | | | | | | | | | | | |
| | | I.R. | In accordance with item No.5 | | | | | | | | | | | | | | | |
| | | Dielectric Strength | In accordance with item No.4 | | | | | | | | | | | | | | | |
| 15 | Temperature Cycle | Appearance | No marking defects | | | | | | | | | | | | | | | |
| | | Capacitance Change | Within ±7.5% | | | | | | | | | | | | | | | |
| | | D.F. | In accordance with item No.7 | | | | | | | | | | | | | | | |
| | | I.R. | In accordance with item No.5 | | | | | | | | | | | | | | | |
| | | Dielectric Strength | In accordance with item No.4 | | | | | | | | | | | | | | | |
| | | | •In case of Reflow Soldering See item 13 Solderability of Termination •In case of Soldering Iron Temp. of solder: 350±10°C Solder time: 4+1/-0 sec. Let sit for 24±2 hrs. at room condition,* then measure. Please refer to "Caution (Soldering and Mounting) Correction with a Soldering Iron". | | | | | | | | | | | | | | | |
| | | | Fix the capacitor to the supporting jig (glass epoxy board) shown in Fig. 4. Perform the 100 cycles according to the 4 heat treatments listed in the following table. Let sit for 24±2 hrs. at room condition*, then measure. | | | | | | | | | | | | | | | |
| | | | <table border="1" data-bbox="933 1433 1452 1556"> <thead> <tr> <th>Step</th> <th>Temperature (°C)</th> <th>Time (min.)</th> </tr> </thead> <tbody> <tr> <td>1</td> <td>Min. Operating Temp. ±3</td> <td>30±3</td> </tr> <tr> <td>2</td> <td>Room Temp.</td> <td>2 to 3</td> </tr> <tr> <td>3</td> <td>Min. Operating Temp. ±2</td> <td>30±3</td> </tr> <tr> <td>4</td> <td>Room Temp.</td> <td>2 to 3</td> </tr> </tbody> </table> | Step | Temperature (°C) | Time (min.) | 1 | Min. Operating Temp. ±3 | 30±3 | 2 | Room Temp. | 2 to 3 | 3 | Min. Operating Temp. ±2 | 30±3 | 4 | Room Temp. | 2 to 3 |
| Step | Temperature (°C) | Time (min.) | | | | | | | | | | | | | | | | |
| 1 | Min. Operating Temp. ±3 | 30±3 | | | | | | | | | | | | | | | | |
| 2 | Room Temp. | 2 to 3 | | | | | | | | | | | | | | | | |
| 3 | Min. Operating Temp. ±2 | 30±3 | | | | | | | | | | | | | | | | |
| 4 | Room Temp. | 2 to 3 | | | | | | | | | | | | | | | | |
| | | | •Pretreatment Perform a heat treatment at 150+0/-10°C for 60±5 min. and then let sit for 24±2 hrs. at room condition.* | | | | | | | | | | | | | | | |
| | | |  <p style="text-align: center;">Fig. 4</p> | | | | | | | | | | | | | | | |

* "Room condition" Temperature: 15 to 35°C, Relative humidity: 45 to 75%, Atmospheric pressure: 86 to 106kPa

Continued on the following page. ↗

For General Purpose KRM/KR3 Series Product Information

KR3 Series Specifications and Test Methods

☐ Continued from the preceding page.

| No. | Item | Specifications | Test Method | | | | | | | | |
|---------------|----------------------------|---------------------|--|---------------|-----------------|--------|---------------------------|--------|---------------------------|--------|---------------------------|
| 16 | Humidity (Steady State) | Appearance | No marking defects | | | | | | | | |
| | | Capacitance Change | Within $\pm 12.5\%$ | | | | | | | | |
| | | D.F. | 0.02 max. | | | | | | | | |
| | | I.R. | More than $1,000M\Omega$ or $10M\Omega \cdot \mu F$ (Whichever is smaller) | | | | | | | | |
| | | Dielectric Strength | In accordance with item No.4 | | | | | | | | |
| | | | Let the capacitor sit at $40\pm 2^{\circ}C$ and relative humidity of 90 to 95% for $500+24/-0$ hrs. Remove and let sit for 24 ± 2 hrs. at room condition*, then measure. •Pretreatment Perform a heat treatment at $150+0/-10^{\circ}C$ for 60 ± 5 min. and then let sit for 24 ± 2 hrs. at room condition.* | | | | | | | | |
| 17 | Life | Appearance | No marking defects | | | | | | | | |
| | | Capacitance Change | Within $\pm 12.5\%$ | | | | | | | | |
| | | D.F. | 0.02 max. | | | | | | | | |
| | | I.R. | More than $1,000M\Omega$ or $10M\Omega \cdot \mu F$ (Whichever is smaller) | | | | | | | | |
| | | Dielectric Strength | In accordance with item No.4 | | | | | | | | |
| | | | Apply voltage as in the Table for $1000+48/-0$ hrs. at maximum operating temperature $\pm 3^{\circ}C$. Remove and let sit for 24 ± 2 hrs. at room condition,* then measure. <table border="1" style="margin: 10px auto; border-collapse: collapse; text-align: center;"> <thead> <tr style="background-color: #f2f2f2;"> <th>Rated Voltage</th> <th>Applied Voltage</th> </tr> </thead> <tbody> <tr> <td>DC250V</td> <td>150% of the rated voltage</td> </tr> <tr> <td>DC450V</td> <td>130% of the rated voltage</td> </tr> <tr> <td>DC630V</td> <td>120% of the rated voltage</td> </tr> </tbody> </table> The charge/discharge current is than 50mA. •Pretreatment Apply test voltage for 60 ± 5 min. at test temperature. Remove and let sit for 24 ± 2 hrs, at room condition.* | Rated Voltage | Applied Voltage | DC250V | 150% of the rated voltage | DC450V | 130% of the rated voltage | DC630V | 120% of the rated voltage |
| Rated Voltage | Applied Voltage | | | | | | | | | | |
| DC250V | 150% of the rated voltage | | | | | | | | | | |
| DC450V | 130% of the rated voltage | | | | | | | | | | |
| DC630V | 120% of the rated voltage | | | | | | | | | | |

* "Room condition" Temperature: 15 to 35°C, Relative humidity: 45 to 75%, Atmospheric pressure: 86 to 106kPa

For General Purpose
 KRM/KR3 Series

Product Information

Package

Taping is standard packaging method.

■ Minimum Quantity Guide

| Part Number | Dimensions (mm) | | | Quantity (pcs.) |
|-------------|-----------------|-----|-----|-----------------|
| | L | W | T | ø330mm Reel |
| K□□31K | 3.5 | 1.7 | 2.7 | 4,000 |
| K□□31F | 3.5 | 1.7 | 1.9 | 5,000 |
| K□□55L | 6.1 | 5.3 | 2.8 | 2,000 |
| K□□55Q | 6.1 | 5.3 | 3.7 | 1,000 |
| K□□55T | 6.1 | 5.3 | 4.8 | 1,000 |
| K□□55W | 6.1 | 5.3 | 6.4 | 500 |

ø180mm reel is also available.

■ Tape Carrier Packaging

(1) Appearance of Taping

Embossed Tape

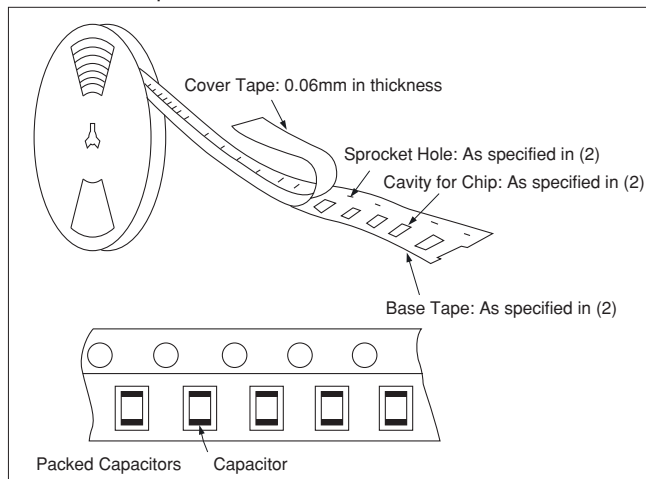

(2) Dimensions of Tape

Embossed Tape

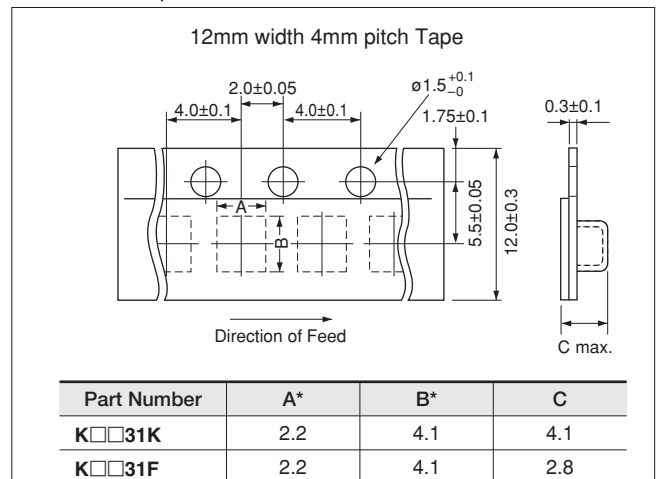

*Nominal Value

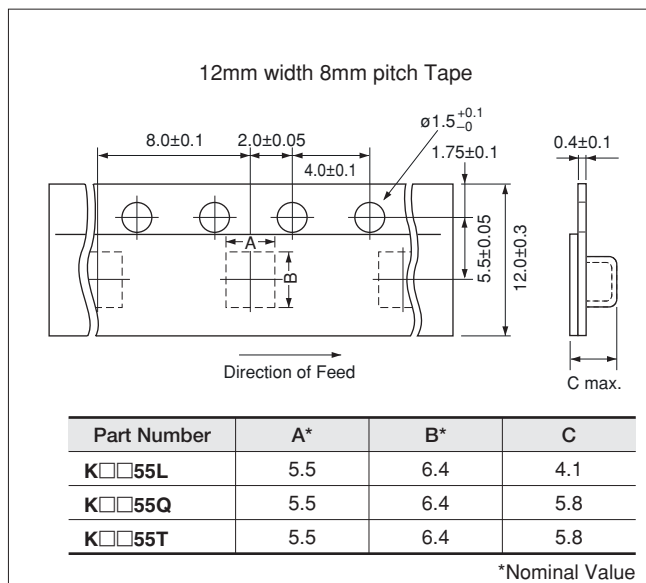

*Nominal Value

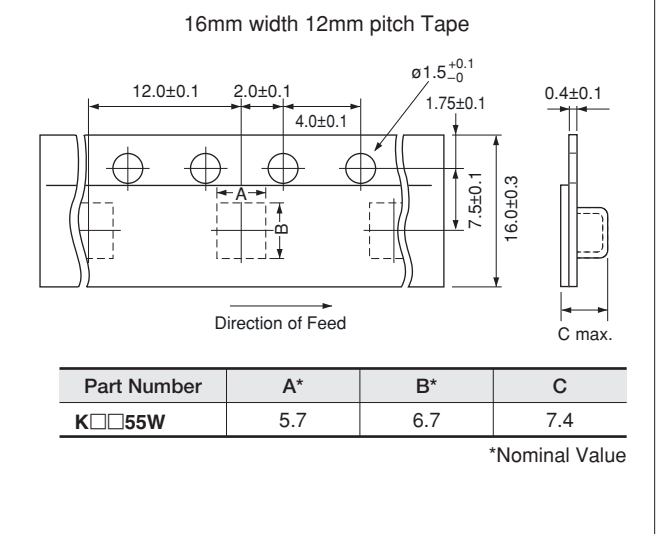

*Nominal Value

(in mm)

Continued on the following page. ↗

Package

☐ Continued from the preceding page.

(3) Dimensions of Reel

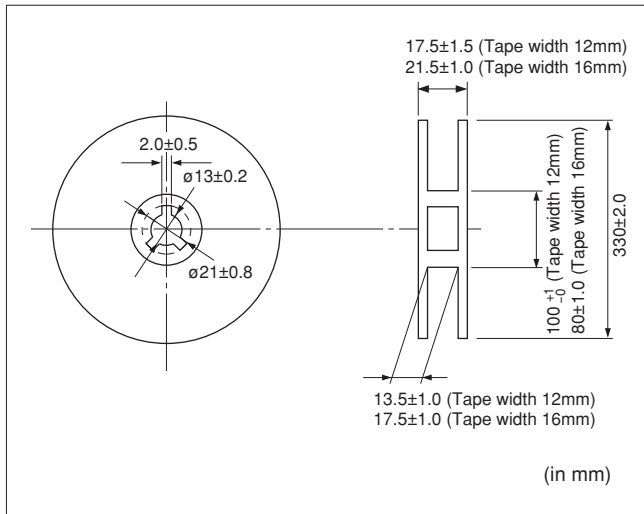

(4) Taping Method

- ① Tapes for capacitors are wound clockwise. The sprocket holes are to the right as the tape is pulled toward the user.
- ② Part of the leader and part of the empty tape should be attached to the end of the tape as shown at right.
- ③ The top tape or cover tape and base tape are not attached at the end of the tape for a minimum of 5 pitches.
- ④ Missing capacitors number within 0.1% of the number per reel or 1 pc, whichever is greater, and are not continuous.
- ⑤ The top tape or cover tape and bottom tape should not protrude beyond the edges of the tape and should not cover sprocket holes.
- ⑥ Cumulative tolerance of sprocket holes, 10 pitches: $\pm 0.3\text{mm}$.
- ⑦ Peeling off force: 0.1 to 0.6N in the direction shown at right.

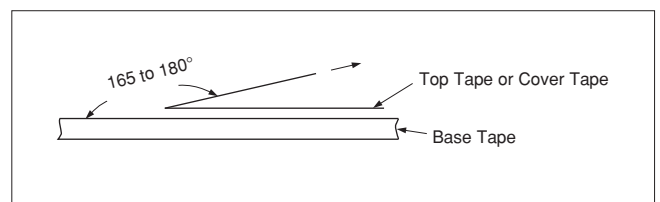
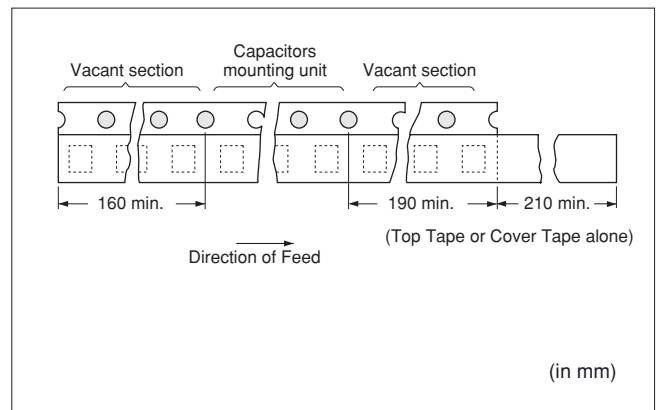

⚠Caution/Notice

⚠Caution

- Storage and Operation Conditions 211
- Rating 211
 - 1. Operating Voltage 211
 - 2. Operating Temperature and Self-generated Heat 211
 - 3. Fail-safe 211
- Soldering and Mounting 212
 - 1. Vibration and Impact 212
 - 2. Land Layout for Cropping PC Board 212
 - 3. Reflow Soldering 212
 - 4. Flow Soldering 213
 - 5. Correction with a Soldering Iron 213

Notice

- Rating 214
 - 1. Capacitance Change of Capacitor 214
 - 2. Performance Check by Equipment 214
- Soldering and Mounting 214
 - 1. Construction of Board Pattern 214
 - 2. Mounting of Chips 214
 - 3. Soldering 214
 - 4. Cleaning 214
 - 5. Resin Coating 214

⚠Caution

■ Storage and Operation Conditions

Do not use or store capacitors in a corrosive atmosphere, especially where chloride gas, sulfide gas, acid, alkali, salt or the like are present. In addition, avoid exposure to moisture. Before cleaning, bonding or molding this product, verify that these processes do not affect product quality by testing the

performance of a cleaned, bonded or molded product in the intended equipment. Store the capacitors where the temperature and relative humidity do not exceed 5 to 40 degrees centigrade and 20 to 70%. Use capacitors within 6 months of delivery. Check the solderability after 6 months or more.

■ Rating

1. Operating Voltage

When DC-rated capacitors are to be used in AC or ripple current circuits, be sure to maintain the V_{p-p} value of the applied voltage or the V_{o-p} which contains DC bias within the rated voltage range.

When the voltage is applied to the circuit, starting or stopping may generate irregular voltage for a transit period because of resonance or switching. Be sure to use a capacitor with a rated voltage range that includes these irregular voltages.

When DC-rated capacitors are to be used in input circuits from a commercial power source (AC filter), be sure to use Safety Certified Capacitors because various regulations for withstanding voltage or impulses, established for all equipment, should be taken into consideration.

| Voltage | DC Voltage | DC+AC Voltage | AC Voltage | Pulse Voltage (1) | Pulse Voltage (2) |
|------------------------|------------|---------------|------------|-------------------|-------------------|
| Positional Measurement | | | | | |

2. Operating Temperature and Self-generated Heat

Keep the surface temperature of a capacitor below the upper limit of its rated operating temperature range. Be sure to take into account the heat generated by the capacitor itself. When the capacitor is used in a high-frequency voltage, pulse voltage, it may self-generate heat due to dielectric loss.

Applied voltage should be the load such as self-generated heat is within 20°C on the condition of atmosphere temperature 25°C. When measuring, use a thermocouple of small thermal capacity -K of $\phi 0.1$ mm in conditions where the capacitor is not affected by radiant heat from other components or surrounding ambient fluctuations. Excessive heat may lead to deterioration of the capacitor's characteristics and reliability. (Never attempt to perform measurement with the cooling fan running. Otherwise, accurate measurement cannot be ensured.)

3. Fail-safe

Failure of a capacitor may result in a short circuit. Be sure to provide an appropriate fail-safe function such as a fuse on your product to help eliminate possible electric shock, fire, or fumes.

Continued on the following page.

For General Purpose
 KRM/KF3 Series

Product Information
 ⚠Caution

⚠Caution

↳ Continued from the preceding page.

■ Soldering and Mounting

1. Vibration and Impact

Do not expose a capacitor to excessive shock or vibration during use.

Do not directly touch the capacitor, especially the ceramic body. Residue from hands/fingers may create a short circuit environment.

2. Land Layout for Cropping PC Board

Choose a mounting position that minimizes the stress imposed on the chip during flexing or bending of the board.

[Component Direction]

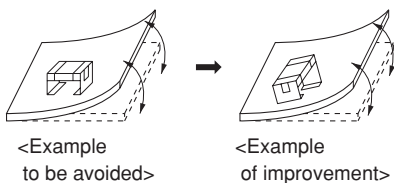

Locate chip horizontal to the direction in which stress acts.

[Chip Mounting Close to Board Separation Point]

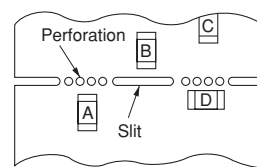

Chip arrangement Worst A>C>B~D Best

3. Reflow Soldering

- When components are exposed to sudden heat, their mechanical strength can be decreased due to the extreme temperature changes which can cause flexing and result in internal mechanical damage, which will cause the parts to fail. In order to prevent mechanical damage, preheating is required for both the components and the PCB board. Preheating conditions are shown in Table 1. It is required to keep the temperature differential between the soldering and the components surface (ΔT) as small as possible.
- When components are immersed in solvent after mounting, be sure to maintain the temperature difference (ΔT) between the component and solvent within the range shown in the Table 1.

Table 1

| Part Number | Temperature Differential |
|-------------|-----------------------------------|
| K□□31 | $\Delta T \leq 190^\circ\text{C}$ |
| K□□55 | $\Delta T \leq 130^\circ\text{C}$ |

Recommended Conditions

| | Pb-Sn Solder | | Lead Free Solder |
|------------------|-----------------|--------------|-----------------------|
| | Infrared Reflow | Vapor Reflow | |
| Peak Temperature | 230-250°C | 230-240°C | 240-260°C |
| Atmosphere | Air | Air | Air or N ₂ |

Pb-Sn Solder: Sn-37Pb

Lead Free Solder: Sn-3.0Ag-0.5Cu

[Standard Conditions for Reflow Soldering]

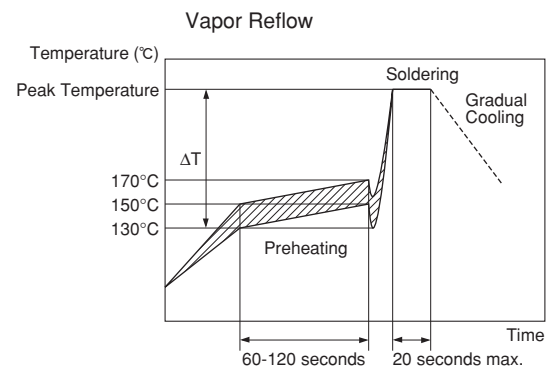
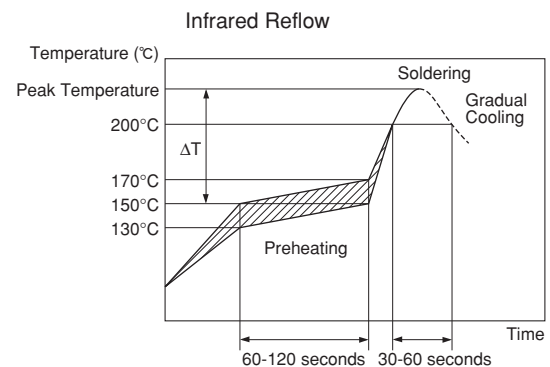

Continued on the following page. ↗

For General Purpose KRM/KR3 Series Product Information ⚠Caution

⚠Caution

☐ Continued from the preceding page.

Optimum Solder Amount for Reflow Soldering

- If solder paste is excessive, solder between a chip and a metal terminal melts. This causes the chip to move and come off.
- If solder paste is too little, it causes a lack of adhesive strength on the metal terminal and the capacitor comes off.
- Please make sure that solder is smoothly applied higher than 0.3mm and lower than the level of the bottom of the chip.

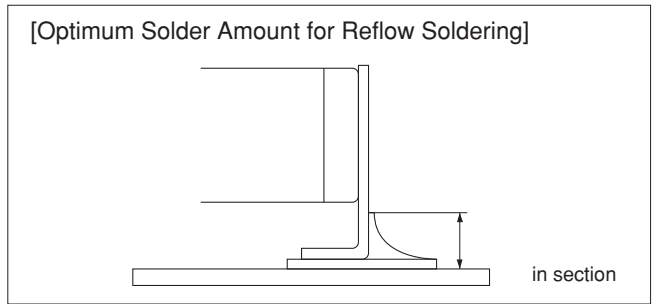

Inverting the PCB

Make sure not to impose an abnormal mechanical shock on the PCB.

4. Flow Soldering

Do not apply flow soldering.

5. Correction with a Soldering Iron

- Please refer to the figure of a soldering iron on the right.
- Please use thread solder which is smaller than 0.5mm in diameter.
- A soldering iron must be touched the bottom of metal terminal.
 - *1) Do not touch ceramic, or it causes cracks because of sudden heat.
 - *2) Do not touch the connection between a chip and a metal and the outside of that area, or it causes the chip to move and come off.

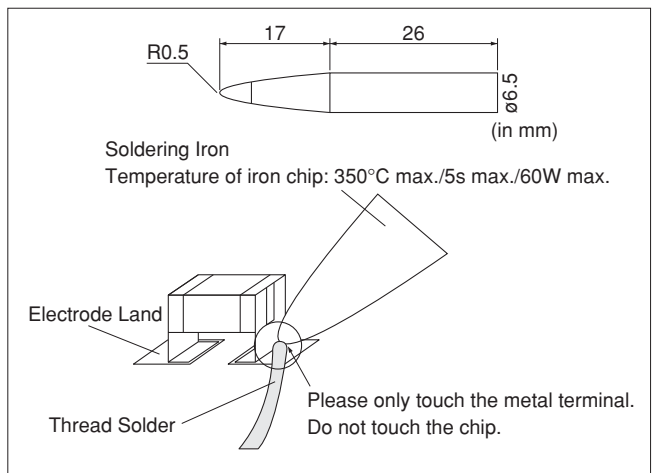

- Optimum Solder Amount when re-working Using a Solder Iron.

The top of the solder fillet should be lower than the level of the bottom of the chip.

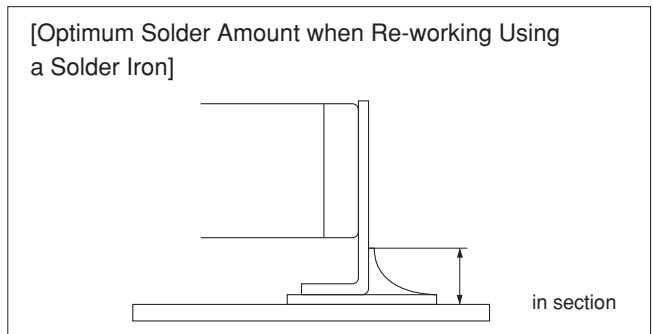

FAILURE TO FOLLOW THE ABOVE CAUTIONS MAY RESULT, WORST CASE, IN A SHORT CIRCUIT AND CAUSE FUMING OR PARTIAL DISPERSION WHEN THE PRODUCT IS USED.

For General Purpose KRM/KF3 Series

Product Information ⚠Caution

Notice

■ Rating

1. Capacitance Change of Capacitor

Capacitors have an aging characteristic, whereby the capacitor continually decreases its capacitance slightly if the capacitor is left on for a long time. Moreover, capacitance might change greatly depending on the surrounding temperature or an applied voltage. Therefore, it is not likely to be suitable for use in a time constant circuit.

Please contact us if you need detailed information.

2. Performance Check by Equipment

Before using a capacitor, check that there is no problem in the equipment's performance and the specifications.

Generally speaking, CLASS 2 ceramic capacitors have voltage dependence characteristics and temperature dependence characteristics in capacitance. Therefore, the capacitance value may change depending on the operating condition in the equipment. Accordingly, be sure to confirm the apparatus performance of receiving influence in a capacitance value change of a capacitor, such as leakage current and noise suppression characteristics. Moreover, check the surge-proof ability of a capacitor in the equipment, if needed, because the surge voltage may exceed the specific value by the inductance of the circuit.

■ Soldering and Mounting

1. Construction of Board Pattern

If solder is excessively applied to the circuit board, mechanical stress will cause destruction resistance characteristics to lower. To prevent this, be extremely careful in determining shape and dimension before designing the circuit board diagram.

Construction and Dimensions of Pattern (Example)

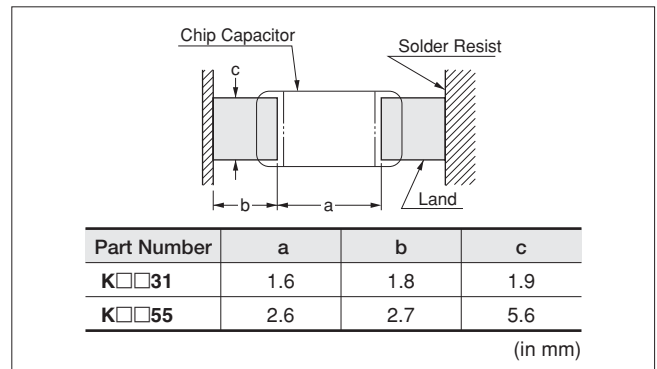

2. Mounting of Chips

Mechanical shock of the chip placer

When the positioning claws and pick-up nozzle are worn, the load is applied to the chip while positioning is concentrated in one position, thus causing cracks, breakage, faulty positioning accuracy, etc.

Careful checking and maintenance are necessary to prevent unexpected trouble.

An excessively low bottom dead point of the suction nozzle imposes great force on the chip during mounting, causing cracked chips and the metal to bend. Please set the suction nozzle's bottom dead point on the upper surface of the board.

3. Soldering

Flux Application

- Do not use strong acidic flux.
- Do not use water-soluble flux.*

(*Water-soluble flux can be defined as non rosin type flux including wash-type flux and non-wash-type flux.)

4. Cleaning

Please confirm there is no problem in the reliability of the product beforehand when cleaning it with the intended equipment.

The residue after cleaning it might cause a decrease in the surface resistance of the chip and the corrosion of the electrode part, etc. As a result it might cause reliability to deteriorate. Please confirm beforehand that there is no problem with the intended equipment in ultrasonic cleansing.

5. Resin Coating

Please use it after confirming there is no influence on the product with the intended equipment before the resin coating and molding.

A cracked chip might be caused at the cooling/heating cycle by the amount of resin spreading and/or bias thickness.

The resin for coating and molding must be selected as the stress is small when stiffening and the hygroscopic is low as possible.

ISO 9001 Certifications

■ Qualified Standards

The products listed here have been produced by ISO 9001 certified factory.

| Plant |
|--|
| Fukui Murata Mfg. Co., Ltd. |
| Izumo Murata Mfg. Co., Ltd. |
| Okayama Murata Mfg. Co., Ltd. |
| Murata Electronics Singapore (Pte.) Ltd. |
| Beijing Murata Electronics Co., Ltd. |
| Wuxi Murata Electronics Co., Ltd. |

Design assistant tool SimSurfing SimSurfing



MLCC is now available !

Design assistant tool "SimSurfing" has been updated and you can now find and view any kind of characteristics of MLCCs.

Available function for MLCCs.

- ① Products search
- ② View frequency characteristics (S parameters, Z, R, X, Q, DF, L, C)
DC bias can be applied to available part number.
- ③ DC voltage bias characteristics (Absolute capacitance/change rate)
- ④ Temperature characteristics (Absolute capacitance/change rate)
- ⑤ AC voltage bias characteristics (Absolute capacitance/change rate)
- ⑥ Download SPICE netlist/ S parameter

1 Select the Products

- (1) By part number
- (2) By specification

2 View characteristics

Clicking buttons in this area with partnumber selected, you can view any electrical characteristics chart.

3 Data download

You can download SPICE netlist and S parameter files (S2P)

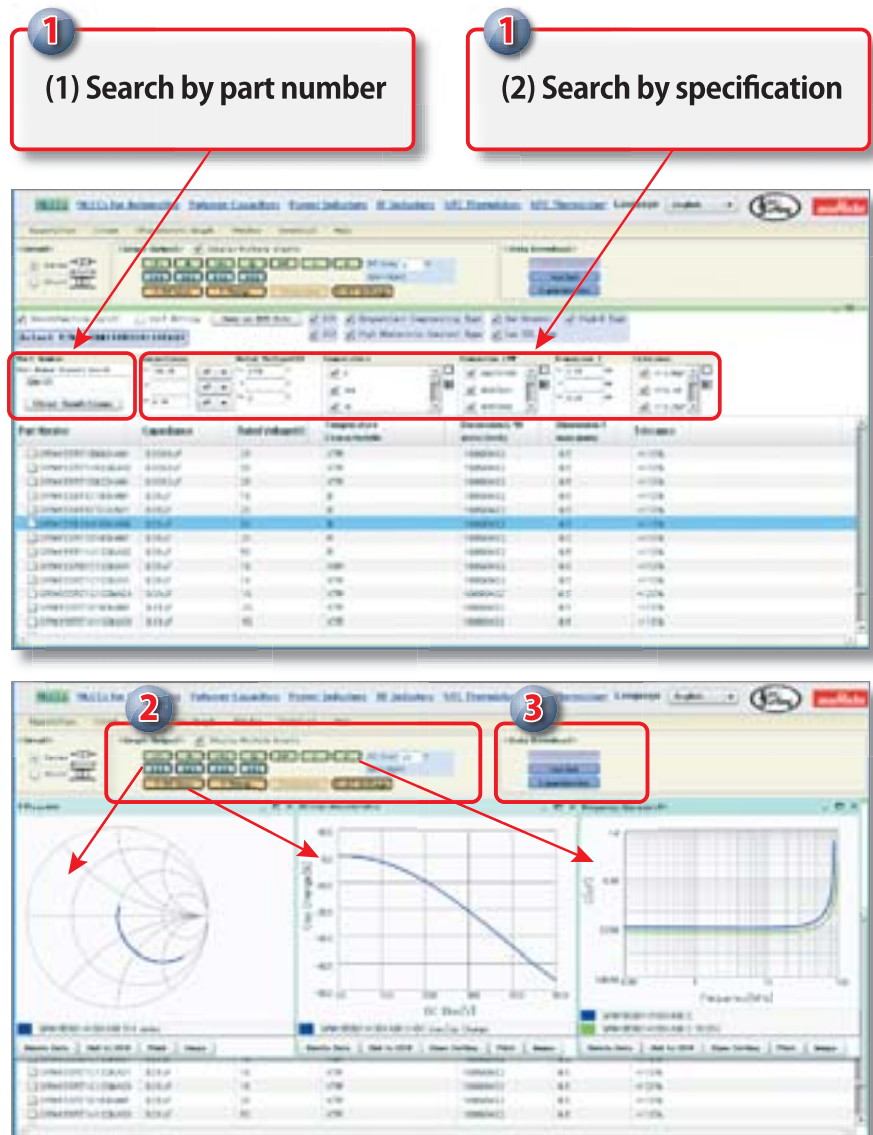

These images are captured at September/2012. Be sure that this software will be updated frequently.

<http://ds.murata.com/software/simsurfing/en-us/mlcc/>

EMICON-FUN!

Please check Murata's newsletter!
 You can learn about electric parts with fun.
http://www.murata.com/products/emicon_fun/

EMICON-FUN! disseminated widely from basics (principles, characteristics, mounting, etc.) of capacitors, inductors and EMI suppression filters to information can practically be used.
 Updated information is also distributed via the mail magazine.

You can register from the Products page on Murata Manufacturing Web site.
<http://www.murata.com/products/>



← This banner is the entrance of register form

The screenshot displays the Murata Manufacturing Co., Ltd. website. The main content area is titled 'EMICON-FUN!' and describes it as an 'email Magazine: Have fun while learning about electronic components'. A featured article is 'Capacitor Room', which 'Introduce quick know-how, and inside story of capacitors'. A sidebar on the right promotes the 'Murata Newsletter' and lists various topics like Capacitor, EMI filters, noise countermeasures, inductors, magnetic field, noise, PLTISH, alternating current, and AVN Car Navigation. A 'Recent articles' section lists several entries with dates and titles, such as 'Noise suppression filter Room' (Sep 14, 2012) and 'Capacitor Room' (Aug 28, 2012). An inset image shows a sample of the newsletter, which includes a table of contents for the October 28 issue, a welcome message, and an introduction to the 'Capacitor Room' column.

Capacitor WEB Site Introduction

The WEB site and search engine of ceramic capacitors has been drastically renewed.

capacitor murata

<http://www.murata.com/products/capacitor/>

- ▶ **Convenient Search** | The type of searches has been increased to respond to various ways of searching.
 The products you are searching for can easily be found from about 40,000 part numbers!
 The frequency of revisions and discontinuance has been increased to provide the latest information at all times!
- ▶ **Substantial Technical Information** |
 - Reference drawings (Specifications and Test Methods) can be downloaded in PDF format.
 - Graphs of the electrical characteristic data (Capacitance - Temperature characteristics / DC bias characteristics / AC voltage characteristics / Frequency characteristics) can be displayed.
 - Reliability test data can be downloaded.



- 1 Search by features**
 Products can be searched by problems, shapes or mounting methods.
- 2 Search in the lineups**
 Products can be searched by entire product lineup.
- 3 Search by specifications**
 Products can be searched by capacitance, rated voltage or temperature characteristics.
- 4 Cross reference search**
 Equivalent products of Murata can be searched by competitors' part numbers.
- 5 Search by part number**
 Products can be searched by Murata's part numbers.

SimSurfing
 This is a WEB application to display characteristics charts of Murata products, and download the characteristics data.

- S parameter
- Netlist (SPICE Model)
- Data Libraries (for Agilent ADS, for AWR Microwave Office®)

Frequently Asked Questions (FAQ)
 This is a collection of questions asked by customers. The contents of problems can easily be searched by keywords with this search function.

Characteristics Data
 (Dimensions / Capacitance - Temperature Characteristics / DC Bias Characteristics / AC Voltage / Frequency Characteristics / Heat Generation by Ripple Currents, etc.)

Reliability Test Data
 Initial Characteristics / Board Bending Resistance / Humidity Resistance / High Temperature Load / Solderability, etc.

Safety Certificates by Series

List of ISO14001 Certified Plants