

High Performance Supercapacitor (EDLC) DMF Series



EU RoHS Compliant

- All the products in this catalog comply with EU RoHS.
- EU RoHS is "the European Directive 2011/65/EU on the Restriction of the Use of Certain Hazardous Substances in Electrical and Electronic Equipment."
- For more details, please refer to our website 'Murata's Approach for EU RoHS' (<http://www.murata.com/en-eu/support/compliance/rohs>).

Safety Standard Certification

- This product is certified by UL810A UL Standard for Safety for Electrochemical Capacitors (First Edition, Dated October 7, 2008).

High Performance Supercapacitor (EDLC) DMF Series: High Power Type ~High capacitance and Low ESR, in small and slim package~

To meet consumer demand for mobile devices with greater efficiency and functionality, Murata began focusing its R&D efforts on supercapacitors (EDLC: Electrical Double Layer Capacitor) in 2008, at which time we made a strategic decision to license leading-edge supercapacitor technology from CAP-XX (CAP-X) an Australia-based firm.



Working from this collaborative basis, Murata has enhanced the design and manufacturer of these high power (low ESR) supercapacitors in a compact, slim package, and we continue our research efforts to develop even better and higher performing products. Supercapacitors are energy storage devices with high power density characteristics that are up to 1,000 times greater than what is typically found in conventional capacitor technology. Murata's supercapacitor combines these advanced characteristics in a small and slim module. Optimization of electrochemical systems, including the electrode structure, enables flexible charging and discharging from high to low output over a range of temperatures. By supporting momentary peak load, the components also level battery load and can drive high-output functions that are difficult for batteries alone.

Features

- World's highest level output power
Discharge up to 50W per piece
- High power density / Small and slim package
Optimum for portable devices or devices with limited space
- High energy / Flexible charge-discharge
Higher power is available by connecting several supercapacitors in series or parallel
- Low ESR and stable ESR even at low temperatures
- Low leakage current: Less than 5µA @96hrs.*1
- High reliability
Characteristic degradation is reduced by excellent sealing package and optimized electrochemical system
- Long charge-discharge cycle life

*1: These figures are based on the data of DMF3Z5R5H474M3DTA0

Benefits

- Leveling the high peak load up to hundreds of milli-seconds
 - Extend battery run time and cycle life by stable combination with EDLC
 - Enable the use of lower power battery or reduction of the number of series connections
 - Enable the use of high peak load applications without high power battery
- Quick Charge and Discharge of High Energy
 - Secure power line from large load change and power down
 - Secure battery power down at lower temperatures
 - Shorten the standby time
- Maintenance-free energy storage device with flexible charge

Applications



- Peak Power Assist
 - LED flash (DVC, DSC, smart phones), smart meters (telecommunication system, valve operation, etc.), e-paper applications, door lock, laser applications (infrared, etc.)
- Backup Applications
 - POS, handy terminal, UPS, last gasp applications
- Energy Harvesting Systems
 - Micro and macro energy harvesting systems
- Battery Peak Load Leveling
 - POS, handy terminal, small motor applications, portable audio, tablet PCs, smart meters, GPS/GPRS tracking systems, fuel cells, primary cell equipment, power tools

Product Lineup

Part Number	Rated Voltage (V)	Nominal Capacitance (mF) (: Tolerance)	Typ. ESR @1kHz (mΩ) (: Max. Value)	Max. Discharge Current (A)	Thickness (mm)	Operating Temperature (°C)	Storage Temperature (°C)
DMF3Z5R5H474M3DTA0	5.5	470 (±20%)	45 (55)	10	3.2 (max. 3.4)	-40 to +70	-40 to +85
DMF4B5R5G105M3DTA0	5.5	1000 (±20%)	40 (50)	10	3.7 (max. 4.0)	-40 to +70	-40 to +85

Marking

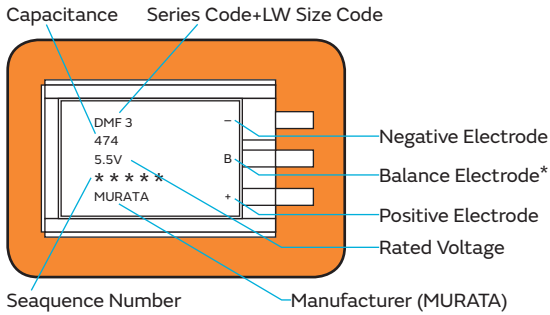

* Balance terminal is used for balance control. Balance control is necessary for this product. For details, please see "Caution <1> Voltage Balance Control".

Part Number Description



① Series

Code	Series
DMF	High Peak Power Type

② External Dimension (L×W×T)

Code	L (mm)	W (mm)	T (mm)
3Z	21.0±0.5	14.0±0.5	3.2 (max. 3.4)
4B	30.0±0.5	14.0±0.5	3.7 (max. 4.0)

③ Rated Voltage

Expressed by three-digit alphanumerics.

Code	Rated Voltage
5R5	DC5.5V

④ ESR

Code	ESR@1kHz
H	45mΩ
G	40mΩ

⑤ Nominal Capacitance

Expressed by three-digit numeric code. The unit is micro-farad(μF). The first and second figures are significant digits, and the third figure expresses the number of zeros which follow the two numbers.

Code	Nominal Capacitance
474	$47 \times 10^4 \mu\text{F} = 470\text{mF}$

⑥ Capacitance Tolerance

Code	Tolerance
M	±20%

⑦ External Terminal

Code	Terminal Specification
3D	3 Terminals (+/-/Balance)

⑧ Packing Code

Code	Packing Specification
T	Tray Type, 50pcs/Tray

⑨ Inhouse Specification Code

Expressed by two-digit alphanumerics.

Dimensions

DMF3Z5R5H474M3DTA0

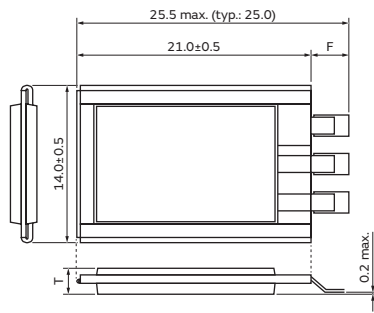

DMF4B5R5G105M3DTA0

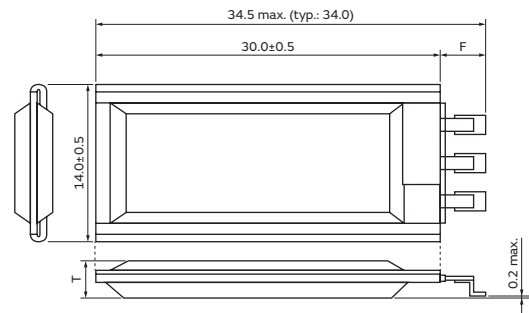

T: Please refer to Product Lineup.

Terminal Size

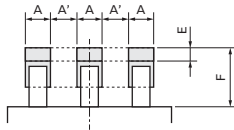

A=1.7±0.2
 A'=1.8±0.5
 E=0.9 (typ.)
 F=4.5 max. (typ.: 4.0)
 E: Length of Soldering Area

(in mm)

Land Pattern Design

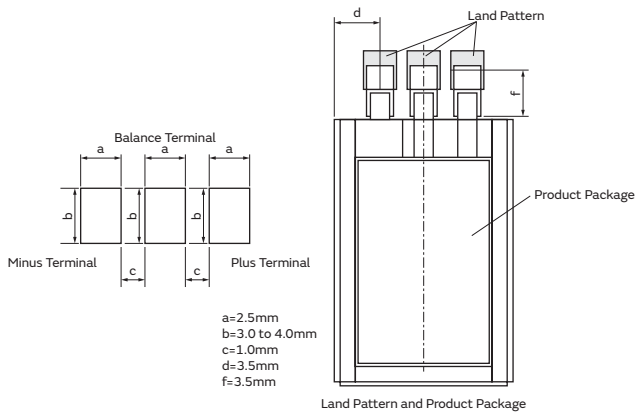

Performance and Validation Method

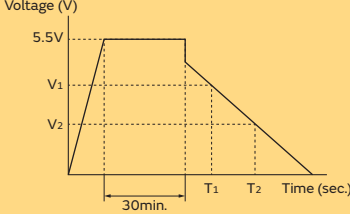
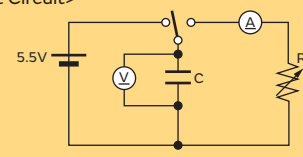
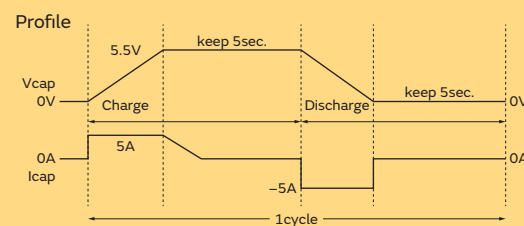
Item	Validation Method	Specification																					
Operating Temperature	—	-40°C to 70°C																					
Nominal Capacitance	<p><Discharge Method> 1. Charge capacitor for 30min. at 5.5V. Charge current: 500mA 2. Then discharge.</p>  <p>V1: 80% of 5.5V V2: 40% of 5.5V T1: Time with voltage V1 T2: Time with voltage V2 I: Discharge current: 100mA</p> <p><Applying Formula> $C = \frac{I \times (T_2 - T_1)}{V_1 - V_2}$</p> <p><Test Circuit></p> 	Please refer to Lineup list.																					
ESR	<p><Impedance Method> Measured at AC1kHz. Charge Current: 10mA</p>	Please refer to Lineup list.																					
Leakage Current @96hrs.	<p>Temperature: 25°C±2°C Charge Voltage: 5.5V Charge Time: 96hrs. Charge up to 5.5V and keep the voltage. Measure the current value after 96hrs. from the time capacitor voltage reaches 5.5V.</p>	<p>DMF3Z5R5H474M3DTA0: Less than 5μA DMF4B5R5G105M3DTA0: Less than 10μA</p>																					
Temperature Characteristics	-40°C to 70°C	<p>Temperature Characteristics</p> <table border="1"> <thead> <tr> <th></th> <th>ESR@1kHz</th> <th>Capacitance</th> </tr> </thead> <tbody> <tr> <td>70°C</td> <td>Less than std value</td> <td>±10%</td> </tr> <tr> <td>40°C</td> <td>Less than std value</td> <td>±10%</td> </tr> <tr> <td>25°C</td> <td>Standard value</td> <td>Standard value</td> </tr> <tr> <td>0°C</td> <td>+40% max.</td> <td>±10%</td> </tr> <tr> <td>-20°C</td> <td>+80% max.</td> <td>±10%</td> </tr> <tr> <td>-40°C</td> <td>+200% max.</td> <td>±10%</td> </tr> </tbody> </table>		ESR@1kHz	Capacitance	70°C	Less than std value	±10%	40°C	Less than std value	±10%	25°C	Standard value	Standard value	0°C	+40% max.	±10%	-20°C	+80% max.	±10%	-40°C	+200% max.	±10%
	ESR@1kHz	Capacitance																					
70°C	Less than std value	±10%																					
40°C	Less than std value	±10%																					
25°C	Standard value	Standard value																					
0°C	+40% max.	±10%																					
-20°C	+80% max.	±10%																					
-40°C	+200% max.	±10%																					
Charge-Discharge Cycle Test	<p>Charge Voltage: 5.5V Charge Current: 5A Discharge Current: 5A Test Temperature: 25°C±2°C Cycle Number: 50,000 times Allow device to sit for 2hrs. min. at 25°C prior to measurement.</p> 	<p>Capacitance Change: · Over 50% of initial value ESR Change(@1kHz): · Under 200% of initial value</p>																					
High Temperature Loading	<p>Charge Voltage: 4.2V Test Temperature: 70°C+0°C/-3°C Duration: 1000hrs.+24/-0hrs. Charge up to 4.2V with 500mA and keep it for 30min. Characteristics are measured at 25°C. Allow device to sit for 2hrs. min. at 25°C prior to measurement. Connect two balance resistors (4.7kΩ or less) in parallel with each capacitor.</p>	<p>Capacitance Change: · Over 70% of initial value ESR Change(@1kHz): · Under 140% of initial value</p>																					

Electrical Characteristics

Capacitance and ESR Temperature Characteristics (V.S. 25°C)

DMF3Z5R5H474M3DTA0

Capacitance

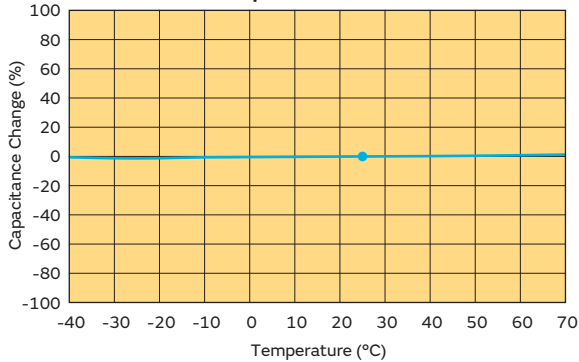

ESR

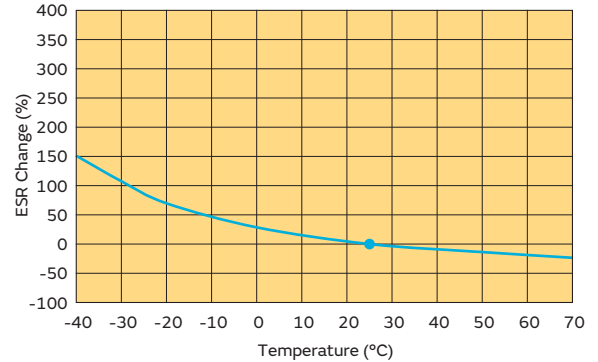

DMF4B5R5G105M3DTA0

Capacitance

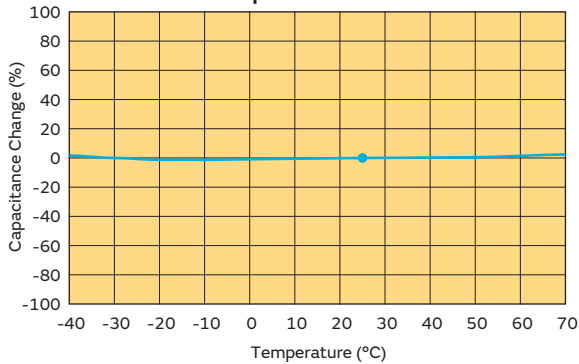

ESR

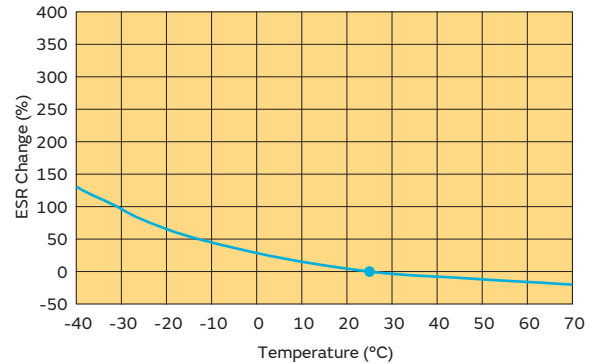

Leakage Current

DMF3Z5R5H474M3DTA0

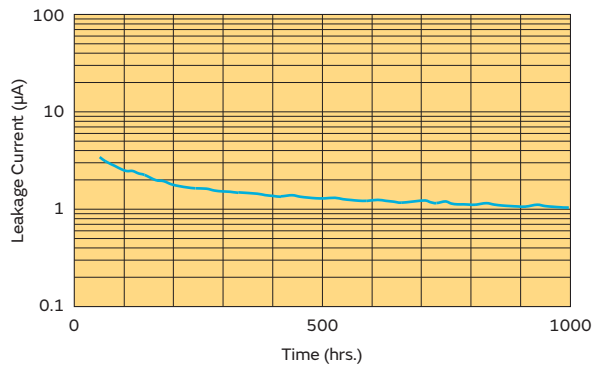

DMF4B5R5G105M3DTA0

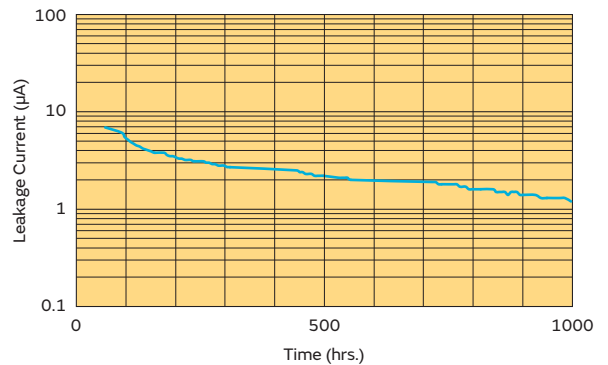

Charge Characteristic

DMF3Z5R5H474M3DTA0

Constant Current Charge (@25°C)

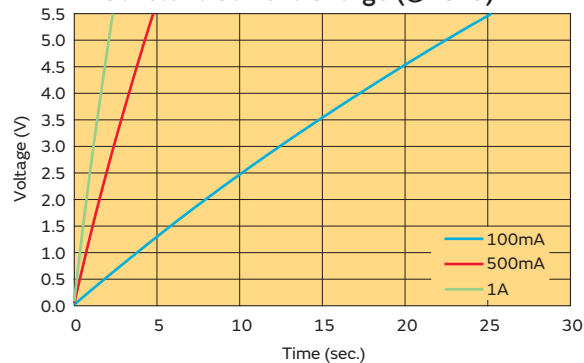

DMF4B5R5G105M3DTA0

Constant Current Charge (@25°C)

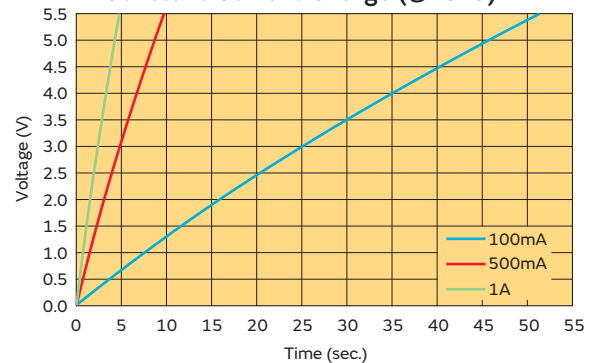

■ Discharge Characteristic

DMF3Z5R5H474M3DTA0

Constant Current Discharge (@25°C)
 (Charge Voltage: 5.5V)

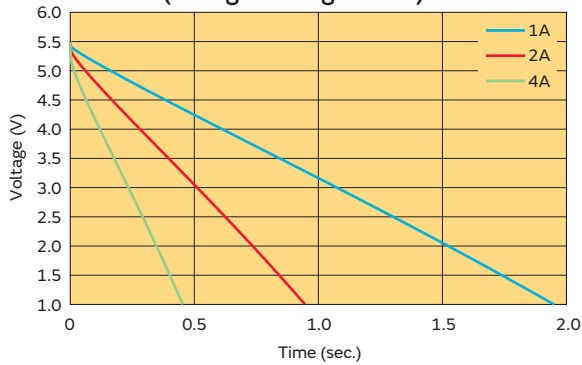

Constant Power Discharge (@25°C)
 (Charge Voltage: 5.5V)

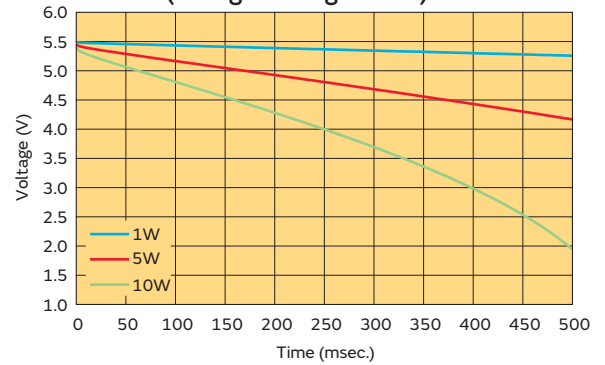

DMF4B5R5G105M3DTA0

Constant Current Discharge (@25°C)
 (Charge Voltage: 5.5V)

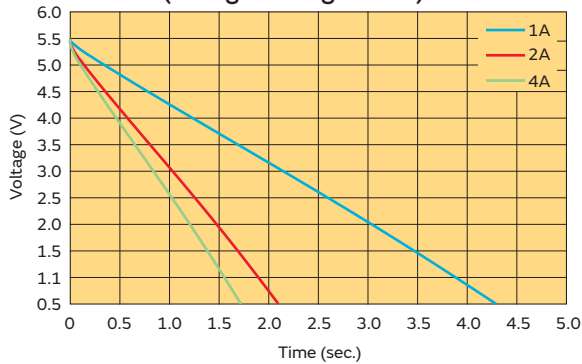

Constant Power Discharge (@25°C)
 (Charge Voltage: 5.5V)

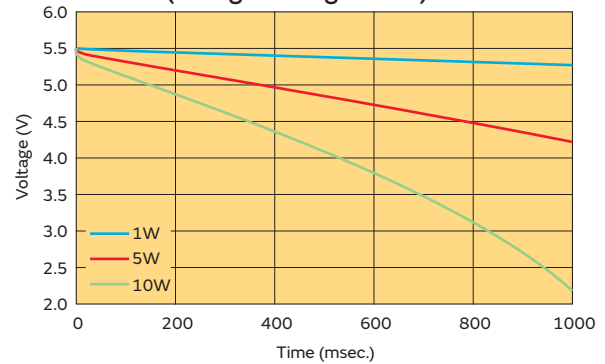

■ Charge-Discharge Cycle Characteristic (Test Condition: Charge Voltage 5.5V@25°C)

DMF3Z5R5H474M3DTA0

Capacitance

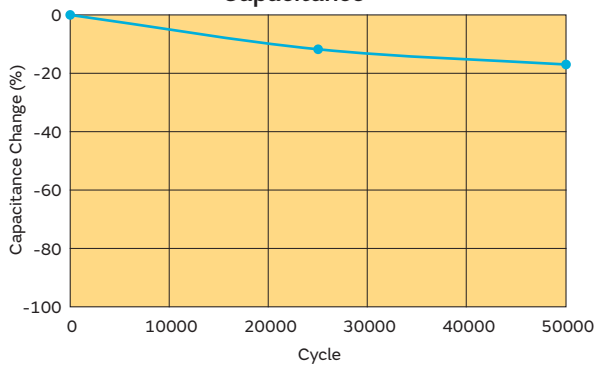

ESR

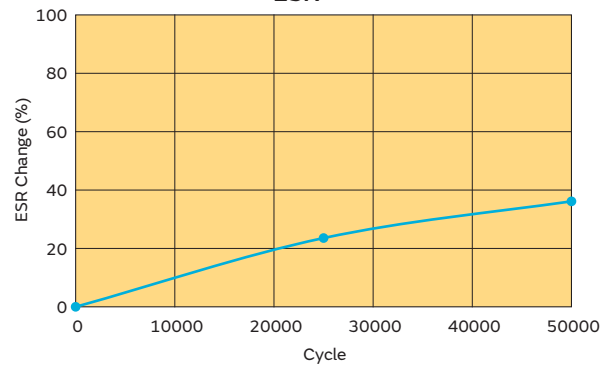

Characteristics are measured at 25,000cycles and 50,000cycles only.

Continued on the following page. ↗

Continued from the preceding page. ↘

DMF4B5R5G105M3DTA0

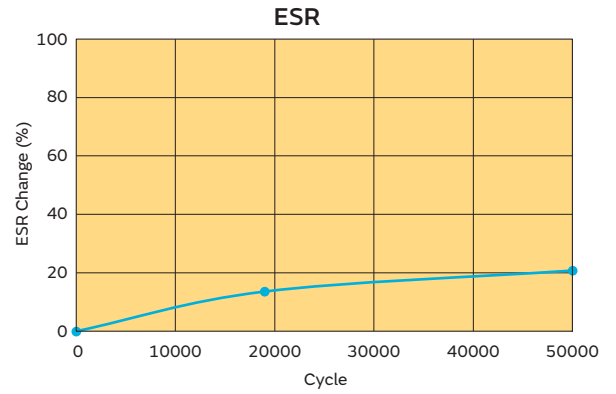
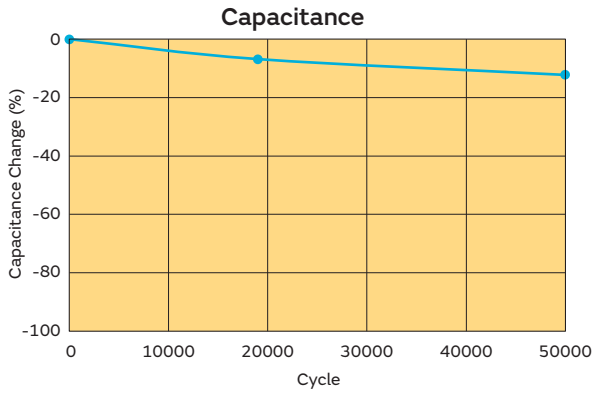

Characteristics are measured at 19,000cycles and 50,000cycles only.

■ High Temperature Loading (Test Condition: Loading Voltage 4.2V@70°C)

DMF3Z5R5H474M3DTA0

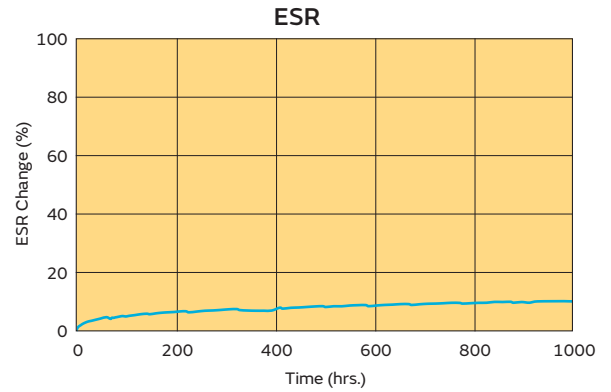
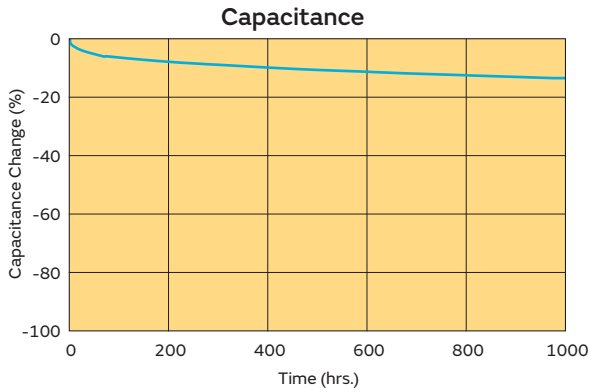

DMF4B5R5G105M3DTA0

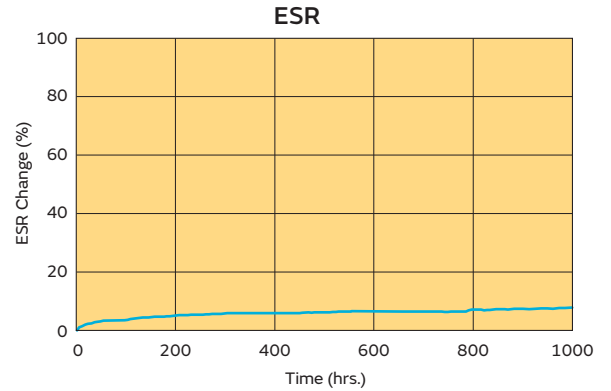
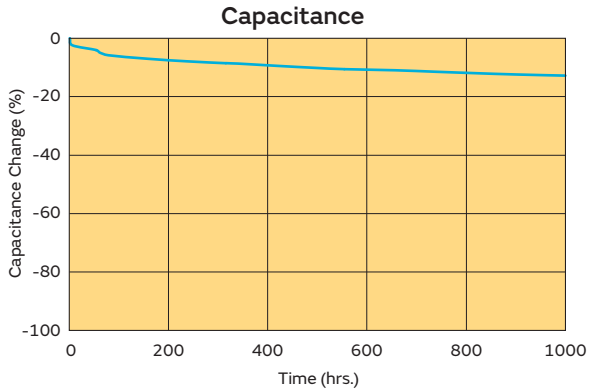

Caution before Use

■ Cautions for Design

- <1> Voltage Balance Control
 - This product consists of two individual cells connected electrically in series. When in use, please be sure to control the voltage of each cell and keep capacitor voltage within operating voltage range (0 to 5.5V). Balance control is needed in order to prevent the excessive voltage (over 1/2 voltage of applied voltage) being applied to either cell. Excessive voltage of either cell may shorten the lifetime of capacitor, distort the capacitor shape or cause electrolyte leakage. For details, please see our specification sheet or contact your local Murata representative.
- <2> Polarity
 - This product has polarity. Please do not reverse polarity when in use. Reverse polarity may damage electrolyte or the electrode inside. Please verify the orientation of the capacitor before use in accordance with the Markings of polarity on the product.
- <3> Considerations for Operation on AC
 - When using this product on AC, not only the effective voltage but also peak voltage should be within operating voltage range (0 to 5.5V).
- <4> Limited Operating Life (Derating)
 - The lifetime of this product depends on temperature and voltage condition. For details, please see our specification sheet or contact your local Murata representative.
- <5> Self Heating Temperature
 - When repeating charge and discharge in a short cycle, self heating is generated by internal resistance. The product temperature should not exceed 70°C, including any self heating.
- <6> Use Environment
 - The capacitor package is covered by insulation layer. In some part, however, metal is exposed. Please keep this product from coming in contact with other device or circuit.
 - This product cannot be used under any acidic or alkaline environment.
 - At extremely low pressure, this product may not be able to provide expected performance.
- <7> Resin Coating
 - If coating/molding the device with resin, there is a risk that some resins may erode metal, or cure-stress of resin may distort terminal or package shape. So please pay careful attention in selecting resin. Prior to use, please make the reliability evaluation with the device mounted in your application set.
- <8> Disassembly
 - This device uses a volatile organic electrolyte. Please do not disassemble it.
- <9> Disposal
 - This device should be disposed of as industrial waste in accordance with local laws and regulations. Never throw this device into fire.
- <10> Response to IATA Dangerous Goods Regulations
 - According to the 54th Edition of IATA Dangerous Goods Regulations effective from January 1, 2013, supercapacitors (EDLCs) with an energy storage capacity greater than 0.3Wh are treated as dangerous goods and introduced as UN3499 in Class 9. However, the energy storage capacity of each of Murata's supercapacitors is not greater than 0.3Wh. Therefore, Murata's supercapacitors are not covered by this regulation.

■ Cautions for Soldering and Assembling ⚠

- (1) Reflow and flow soldering cannot be used because a capacitor body temperature will rise beyond the maximum allowable temperature. Please use other mounting methods. These may include hand soldering, etc.
- (2) Please do not apply excessive force to the capacitor during insertion as well as after soldering. The excessive force may result in damage to electrode terminals and/or degradation of electrical performance.
- (3) Hand Soldering
 - Please solder under following conditions.
 - Solder Type: Resin flux cored solder wire (ø1.2mm)
 - Solder: Lead-free solder: Sn-3Ag-0.5Cu
 - Soldering iron temperature at 350°C±10°C
 - Solder iron wattage: 70W or less
 - Soldering time: 3 to 4sec.
 - Allowable soldering frequencies: Max. 3 times/terminal.
 - Please do not touch laminate package directly with the solder iron.
- (4) Please do not wash the device after soldering.

■ Storage Conditions

- Storage condition without opening outer package
 - 30°C 60%RH for 1year (Before opening outer package)
 - * Remark: This product cannot be baked.
- Storage conditions after opening outer package
 - (1) Term of warranty of this device is 3 months after sealed outer package is opened.
 - (2) Storage environment
 - Please adhere to the following conditions in sealed package.
 - Temperature: 5 to 35°C
 - Humidity: no more than 70%RH. No condensation.
 - Avoid any acidic or alkaline environment.
 - Avoid excessive external force while in storage.
 - (3) Please keep device in sealed outer package before use.
 - (4) Please do not apply any heat treatment before use.

Packaging

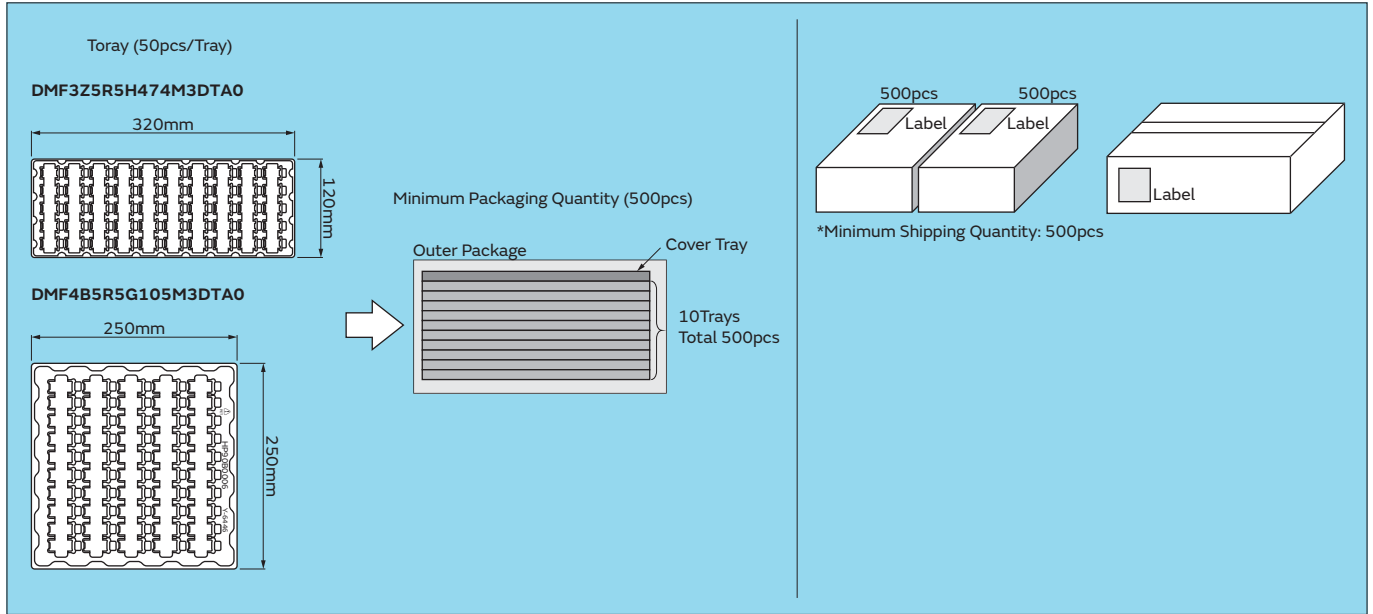

Global Locations

For details please visit www.murata.com



⚠ Note

1 Export Control

For customers outside Japan:

No Murata products should be used or sold, through any channels, for use in the design, development, production, utilization, maintenance or operation of, or otherwise contribution to (1) any weapons (Weapons of Mass Destruction [nuclear, chemical or biological weapons or missiles] or conventional weapons) or (2) goods or systems specially designed or intended for military end-use or utilization by military end-users.

For customers in Japan:

For products which are controlled items subject to the "Foreign Exchange and Foreign Trade Law" of Japan, the export license specified by the law is required for export.

2 Please contact our sales representatives or product engineers before using the products in this catalog for the applications listed below, which require especially high reliability for the prevention of defects which might directly damage a third party's life, body or property, or when one of our products is intended for use in applications other than those specified in this catalog.

- ① Aircraft equipment
- ② Aerospace equipment
- ③ Undersea equipment
- ④ Power plant equipment
- ⑤ Medical equipment
- ⑥ Transportation equipment (vehicles, trains, ships, etc.)
- ⑦ Traffic signal equipment
- ⑧ Disaster prevention / crime prevention equipment
- ⑨ Data-processing equipment
- ⑩ Application of similar complexity and/or reliability requirements to the applications listed above

3 Product specifications in this catalog are as of May 2016. They are subject to change or our products in it may be discontinued without advance notice. Please check with our sales representatives or product engineers before ordering. If there are any questions, please contact our sales representatives or product engineers.

4 Please read rating and ⚠CAUTION (for storage, operating, rating, soldering, mounting and handling) in this catalog to prevent smoking and/or burning, etc.

5 This catalog has only typical specifications. Therefore, please approve our product specifications or transact the approval sheet for product specifications before ordering.

6 Please note that unless otherwise specified, we shall assume no responsibility whatsoever for any conflict or dispute that may occur in connection with the effect of our and/or a third party's intellectual property rights and other related rights in consideration of your use of our products and/or information described or contained in our catalogs. In this connection, no representation shall be made to the effect that any third parties are authorized to use the rights mentioned above under licenses without our consent.

7 No ozone depleting substances (ODS) under the Montreal Protocol are used in our manufacturing process.

Murata Manufacturing Co., Ltd.

www.murata.com

muRata
INNOVATOR IN ELECTRONICS