

DE2E3KH152MA3B

" # " indicates a package specification code.



< List of part numbers with package codes >
DE2E3KH152MA3B

Shape

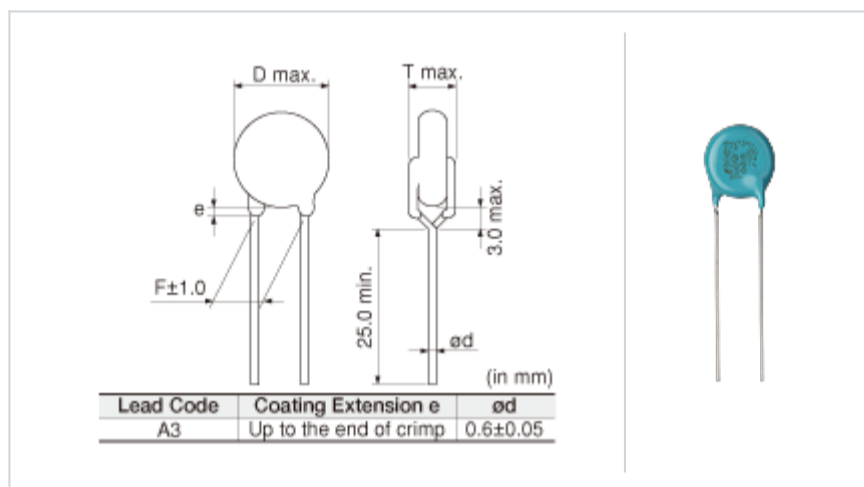

Notes

X1/Y2 Class Certified Products
Please use replacement

References

Packaging	Specifications	Minimum quantity
B	Packing in bulk	250

L size or outer diameter D (mm)	9.0 mm max.
T size	7.0 mm max.
Lead spacing F	7.5 ± 1.0mm
Lead diameter d	0.6 ± 0.05mm
Paint dripping e	Up to the end of crimp

Specifications

Capacitance	1500pF ± 20%
Rated voltage	250Vac(r.m.s.)
Temperature characteristics (complied standard)	E(JIS)
Capacitance change rate	+20/-55%
Temperature range of temperature characteristics	-25 to 85
Operating temperature range	-40 to 125

⚠ Attention

- 1.This datasheet is downloaded from the website of Murata Manufacturing Co., Ltd. Therefore, it ' s specifications are subject to change or our products in it may be discontinued without advance notice. Please check with our sales representatives or product engineers before ordering.
- 2.This datasheet has only typical specifications because there is no space for detailed specifications. Therefore, please review our product specifications or consult the approval sheet for product specifications before ordering.