

# Chip Monolithic Ceramic Capacitors

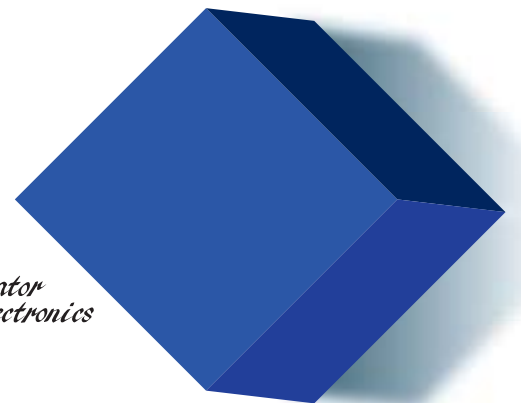
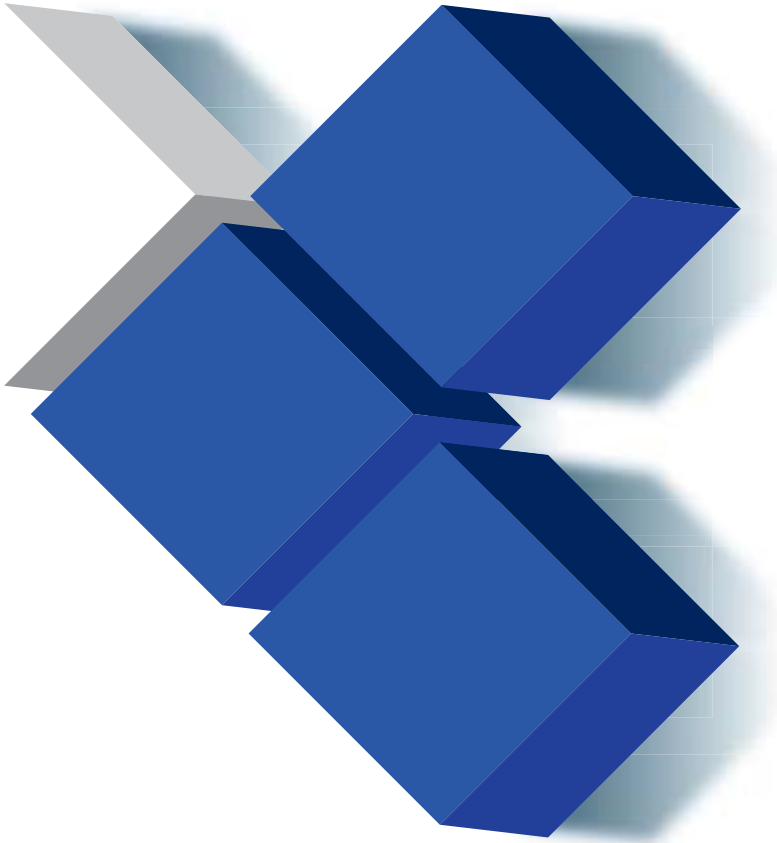

Murata  
Manufacturing Co., Ltd.

*Innovator  
in Electronics*

## Explanation of Symbols in This Catalog

**Ultra-compact**

Lx W dimension: products of 0.6 x 0.3 mm or less

**HiQ**

Low dissipation for high frequency  
 By devising ceramic materials and electrode materials, low dissipation is achieved in frequency bands of VHF, UHF and microwave or beyond.

**Low ESL**

Low inductance  
 This capacitor is designed so that the parasitic inductance component (ESL) that the capacitor has on the high frequency side becomes lower.

**Anti-noise**

Product suitable for acoustic noise reduction and low distortion  
 This product suppresses acoustic noise, which occurs when a ceramic capacitor is used, by devising the materials and configuration.

**Deflecting crack**

Product resistant to deflection cracking  
 This capacitor is designed to prevent failures as much as possible by short mode caused by cracking when there is board deflection.

**Soldering crack**

Product with solder cracking suppression  
 This capacitor is configured with metal terminals and leads connected to the chip. The metal terminals and leads relieve the stress from expansion and contraction of the solder, to suppress solder cracking.

**Derating**

Voltage and temperature derating recommended product  
 This product is suitable when a voltage continuously applied to a capacitor in an operating circuit, is used below (derated) the rated voltage of the capacitor.  
 This model guarantees the test conditions in the endurance test, at a rated voltage x 100% at the maximum operating temperature. A reliability assurance level equivalent to a common product can be secured, by using this product within the voltage and temperature derated conditions recommended in the figure below.

Recommended Conditions of the Derating Operating Voltage and Temperature

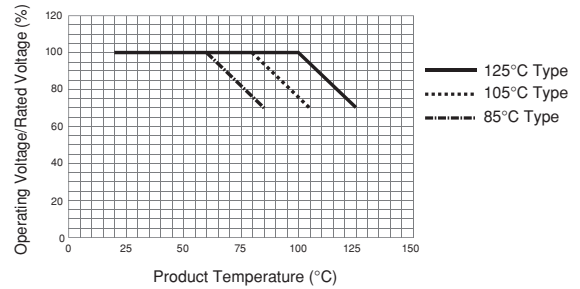

**EU RoHS Compliant**

- All the products in this catalog comply with EU RoHS.
- EU RoHS is "the European Directive 2011/65/EU on the Restriction of the Use of Certain Hazardous Substances in Electrical and Electronic Equipment."
- For more details, please refer to our website 'Murata's Approach for EU RoHS' (<http://www.murata.com/info/rohs.html>).

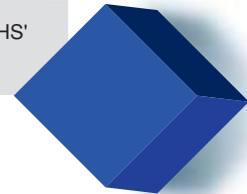

## For General Purpose GRM Series Capacitance Table

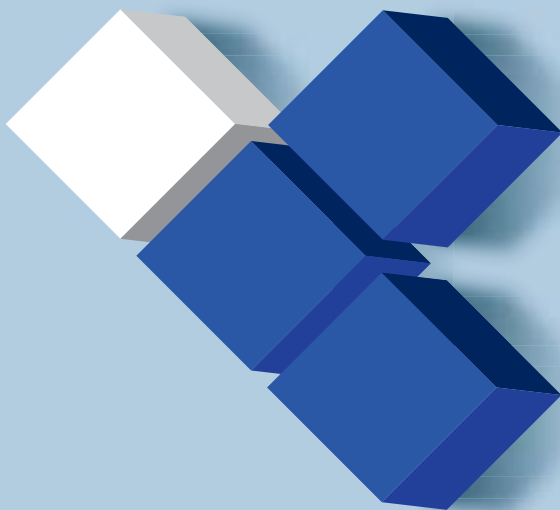

# Contents

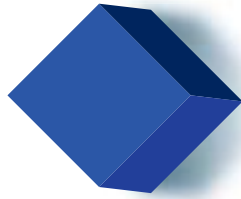

Product specifications are as of July 2012.

Selection Guide .....	p2
Capacitance Table .....	p3
Part Numbering .....	p15

## Chip Monolithic Ceramic Capacitors

Cap. Table

For General Purpose GRM Series (Less than 250Vdc) .....	p21	separate volume
--	-----	-----------------

Capacitor Array GNM Series .....	p76	p4
----------------------------------	-----	----

Low ESL LLL/LLR/LLA/LLM Series .....	p79	p5
--------------------------------------	-----	----

High-Q Type GJM Series .....	p82	p7
------------------------------	-----	----

High Frequency GQM Series .....	p104	p8
---------------------------------	------	----

Monolithic Microchip GMA Series .....	p113	p9
---------------------------------------	------	----

For Bonding GMD Series .....	p115	p10
------------------------------	------	-----

⚠Caution/Notice .....	p118
-----------------------	------

## Chip Monolithic Ceramic Capacitors (Medium Voltage)

Cap. Table

### For General Purpose GRM (250Vdc min.)/GRJ/GR3 Series

Temperature Compensating Type		
GRM Series (250Vdc min.) .....	p136	separate volume
High Dielectric Constant Type		
GRM Series (250Vdc min.) .....	p143	separate volume
Soft Termination Type GRJ Series .....	p148	p11
Large Capacitance and High Allowable		
Ripple Current GR3 Series .....	p153	p11

### Only for Applications

For LCD Backlight Inverter Circuit		
GRM/DC3.15kV Series .....	p158	p12
For Information Devices GR4 Series .....	p161	p12
For Camera Flash Circuit GR7 Series .....	p165	p12

### AC250V Type (Which Meet Japanese Law)

GA2 Series .....	p169	p12
------------------	------	-----

### Safety Standard Certified GA3 Series

UL, IEC60384-14 Class X1/Y2 Type GC ..	p173	p13
IEC60384-14 Class Y2, X1/Y2 Type GF ..	p174	p13
IEC60384-14 Class Y3 Type GD .....	p176	p13
IEC60384-14 Class X2 Type GB .....	p177	p13

Reference Data (Typical Example) .....	p182
Package .....	p185
⚠Caution/Notice .....	p188

## Metal Terminal Monolithic Ceramic Capacitors

Cap. Table

### For General Purpose KRM/KR3 Series

High Capacitance for General Use		
KRM Series .....	p200	p14
Large Capacitance and High Allowable		
Ripple Current KR3 Series .....	p204	p14

Package .....	p208
⚠Caution/Notice .....	p210

ISO 9001 Certifications .....	p215
Introduction of WEB SimSurfing .....	p216
EMICON-FUN! .....	p217
Product Information .....	p218

Please check the MURATA home page (<http://www.murata.com/>) if you cannot find the part number in the catalog.

## Selection Guide For Chip Monolithic Ceramic Capacitors

	Function	Type	Series
Applications?	Decoupling, Smoothing	High Capacitance	<b>GRM (X5R, X7R, Y5V etc.)</b> 68pF–150μF
		Array (2 or 4 Elements)	<b>GNM</b> 470pF–2.2μF
	Frequency Control/Tuning, Impedance Matching	Class 1 TC's	<b>GRM (C0G)</b> 0.1pF–0.1μF
			<b>GRM (U2J etc.)</b>
	High Speed Decoupling	Low Inductance (Reverse Geometry)	<b>LLL</b> 2200pF–10μF
		Low Inductance (Controlled ESR)	<b>LLR</b> 1.0μF
		Low Inductance (Multi-Termination)	<b>LLA/LLM (From 1GHz)</b> 0.01μF–4.7μF
	High Frequency	Low ESR, Ultra Small	<b>GJM (500MHz to 10GHz)</b> 0.1pF–47pF
		Lowest ESR	<b>GQM (500MHz to 10GHz)</b> 0.1pF–100pF
	Optical Communications	Wire-Die-Bonding	<b>GMA</b> 100pF–0.47μF <b>GMD</b> 100pF–0.47μF
	250Vdc min. High-Frequency Snubber	250V/630V/1kV/2kV/3.15kV Low Dissipation	<b>GRM (C0G, U2J)</b> 10pF–47000pF
	250Vdc min. LCD Backlight Inverter	3.15kV Low Dissipation	<b>GRM (C0G)</b> 5pF–47pF
	250Vdc min. Decoupling, Smoothing	250V/630V/1kV High Capacitance	<b>GRM (X7R)</b> 220pF–1μF
		250V/630V/1kV Soft Termination	<b>GRJ (X7R)</b> 470pF–1μF
		250V/450V/630V Large Capacitance and High Allowable Ripple Current	<b>GR3 (X7T)</b> 10000pF–1μF
	250Vdc min. For Camera Flash Circuit only	350V High Capacitance	<b>GR7</b> 10000pF–47000pF
	250Vdc min. For Information Devices only	2kV High Capacitance	<b>GR4</b> 100pF–10000pF
		Safety Standard Certified	<b>Type GD</b> 10pF–4700pF <b>Type GF</b> 10pF–4700pF
AC Lines Noise Removal	Safety Standard Certified	<b>Type GC</b> 100pF–330pF <b>Type GF</b> 470pF–4700pF <b>Type GB</b> 10000pF–56000pF	
	AC250V which meets Japanese Law	<b>GA2</b> 470pF–0.1μF	
Automotive (Powertrain, Safety Equipment)	High Capacitance	<b>GCM (X7R etc.)</b> 100pF–47μF	
	Class 1 TC's	<b>GCM (C0G etc.)</b> 1.0pF–56000pF	
250Vdc min. for Automotive (Powertrain, Safety Equipment)	250V/630V/1kV Low Dissipation	<b>GCM (U2J)</b> 10pF–47000pF	
	250V/630V Soft Termination	<b>GCJ (X7R)</b> 1000pF–0.47μF	

## Capacitance Table

### ● Temperature Characteristics Table

Temperature Characteristic Codes		Temperature Characteristics			Operating Temperature Range	Capacitance Change Each Temperature (%)					
						-55°C		-25°C		-10°C	
Public STD Code	Reference Temperature	Temperature Range	Capacitance Change or Temperature Coefficient	Max.		Min.	Max.	Min.	Max.	Min.	
				C0G	EIA	25°C	25 to 125°C	0±30ppm/°C	-55 to 125°C	0.58	-0.24
C0H	EIA	25°C	25 to 125°C	0±60ppm/°C	-55 to 125°C	0.87	-0.48	0.59	-0.33	0.38	-0.21
CK	JIS	20°C	20 to 125°C	0±250ppm/°C	-55 to 125°C	2.56	-1.88	1.54	-1.13	1.02	-0.75
CJ	JIS	20°C	20 to 125°C	0±120ppm/°C	-55 to 125°C	1.37	-0.9	0.82	-0.54	0.55	-0.36
CH	JIS	20°C	20 to 125°C	0±60ppm/°C	-55 to 125°C	0.82	-0.45	0.49	-0.27	0.33	-0.18
SL	JIS	20°C	20 to 85°C	+350 to -1000ppm/°C	-55 to 125°C	-	-	-	-	-	-
P2H	EIA	25°C	25 to 85°C	-150±60ppm/°C	-55 to 125°C	2.33	0.72	1.61	0.5	1.02	0.32
PK	JIS	20°C	20 to 85°C	-150±250ppm/°C	-25 to 85°C	-	-	2.36	-0.45	1.57	-0.3
PJ	JIS	20°C	20 to 85°C	-150±120ppm/°C	-25 to 85°C	-	-	1.65	0.14	1.1	0.09
PH	JIS	20°C	20 to 85°C	-150±60ppm/°C	-25 to 85°C	-	-	1.32	0.41	0.88	0.27
R2H	EIA	25°C	25 to 85°C	-220±60ppm/°C	-55 to 125°C	3.02	1.28	2.08	0.88	1.32	0.56
RK	JIS	20°C	20 to 85°C	-220±250ppm/°C	-25 to 85°C	-	-	2.74	-0.14	1.83	-0.09
RJ	JIS	20°C	20 to 85°C	-220±120ppm/°C	-25 to 85°C	-	-	2.03	0.45	1.35	0.3
RH	JIS	20°C	20 to 85°C	-220±60ppm/°C	-25 to 85°C	-	-	1.7	0.72	1.13	0.48
S2H	EIA	25°C	25 to 85°C	-330±60ppm/°C	-55 to 125°C	4.09	2.16	2.81	1.49	1.79	0.95
SK	JIS	20°C	20 to 85°C	-330±250ppm/°C	-25 to 85°C	-	-	3.35	0.36	2.23	0.24
SJ	JIS	20°C	20 to 85°C	-330±120ppm/°C	-25 to 85°C	-	-	2.63	0.95	1.76	0.63
SH	JIS	20°C	20 to 85°C	-330±60ppm/°C	-25 to 85°C	-	-	2.3	1.22	1.54	0.81
T2H	EIA	25°C	25 to 85°C	-470±60ppm/°C	-55 to 125°C	5.46	3.28	3.75	2.26	2.39	1.44
TK	JIS	20°C	20 to 85°C	-470±250ppm/°C	-25 to 85°C	-	-	4.12	0.99	2.74	0.66
TJ	JIS	20°C	20 to 85°C	-470±120ppm/°C	-25 to 85°C	-	-	3.4	1.58	2.27	1.05
TH	JIS	20°C	20 to 85°C	-470±60ppm/°C	-25 to 85°C	-	-	3.07	1.85	2.05	1.23
U2J	EIA	25°C	25 to 125°C	-750±120ppm/°C	-55 to 125°C	8.78	5.04	6.04	3.47	3.84	2.21
UK	JIS	20°C	20 to 85°C	-750±250ppm/°C	-25 to 85°C	-	-	5.65	2.25	3.77	1.5
UJ	JIS	20°C	20 to 85°C	-750±120ppm/°C	-25 to 85°C	-	-	4.94	2.84	3.29	1.89
X7R	EIA	25°C	-55 to 125°C	±15%	-55 to 125°C	-	-	-	-	-	-
X7S	EIA	25°C	-55 to 125°C	±22%	-55 to 125°C	-	-	-	-	-	-
X7T	EIA	25°C	-55 to 125°C	+22%, -33%	-55 to 125°C	-	-	-	-	-	-
X7U	EIA	25°C	-55 to 125°C	+22%, -56%	-55 to 125°C	-	-	-	-	-	-
R	JIS	20°C	-55 to 125°C	±15%	-55 to 125°C	-	-	-	-	-	-
X6S	EIA	25°C	-55 to 105°C	±22%	-55 to 105°C	-	-	-	-	-	-
X6T	EIA	25°C	-55 to 105°C	+22%, -33%	-55 to 105°C	-	-	-	-	-	-
X5R	EIA	25°C	-55 to 85°C	±15%	-55 to 85°C	-	-	-	-	-	-
X5S	EIA	25°C	-55 to 85°C	±22%	-55 to 85°C	-	-	-	-	-	-
B	JIS	20°C	-25 to 85°C	±10%	-25 to 85°C	-	-	-	-	-	-
-: Murata Temperature Characteristic		25°C	-55 to 125°C	±10%	-55 to 125°C	-	-	-	-	-	-

### ■ GRM Series

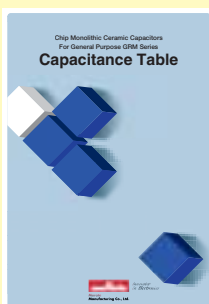

For the Capacitance Table of General Purpose GRM Series, please review the inserted Capacitance Table of "Chip Monolithic Ceramic Capacitor and General Purpose GRM Series".

# Capacitance Table

p00

Each number in the Part Number List refers to the page number printed at the bottom of the page.

## GRM Series Temperature Compensating Type

p00

← Part Number List

JIS:

CK

CJ

CH

SL

PK

PJ

PH

RK

RJ

RH

SK

SJ

SH

TK

TJ

TH

UK

UJ

EIA:

C0G

P2H

R2H

S2H

T2H

U2J

LxW (mm)	0.4x0.2				0.6x0.3								1.0x0.5									
T max. (mm)	0.22				0.33								0.33				0.55					
Rated Voltage (Vdc)	16		10		50			25					50				50					
Cap. / TC Code	C0G	CΔ	C0G	CH	C0G	CΔ	UΔ	R2H	RΔ	S2H	SΔ	T2H	TΔ	UJ	C0G	CΔ	C0G	CΔ	P2H	PΔ	R2H	RΔ
0.1pF					p28	p32									p36	p38	p39	p42				
0.2pF	p22	p25			p28	p32									p36	p38	p39	p42				
0.5pF	p22	p25			p28	p32									p36	p38	p39	p42				
1.0pF	p22	p25			p28	p32	p35	p35	p35	p35	p36	p36	p36		p37	p38	p39	p42	p46	p46	p46	p46
2.0pF	p22	p25			p29	p32	p35	p35	p35	p36	p36	p36	p36		p37	p38	p39	p43	p46	p46	p46	p46
3.0pF	p22	p25			p29	p32	p35	p35	p35	p36	p36	p36	p36		p37	p38	p39	p43	p46	p46	p46	p46
4.0pF	p23	p26			p29	p33	p35	p35	p35	p36	p36	p36	p36		p37	p38	p40	p43	p46	p46	p46	p46
5.0pF	p23	p26			p30	p33	p35	p35	p35	p36	p36	p36	p36		p37	p38	p40	p44	p46	p46	p46	p46
6.0pF	p23	p26			p30	p33	p35	p35	p35	p36	p36	p36	p36		p37	p38	p40	p44	p46	p46	p46	p46
7.0pF	p24	p27			p30	p34	p35	p35	p35	p36	p36	p36	p36		p37	p38	p41	p44	p46	p46	p46	p46
8.0pF	p24	p27			p31	p34	p35	p35	p35	p36	p36	p36	p36		p37	p38	p41	p45	p46	p46	p46	p46
9.0pF	p24	p28			p31	p34	p35	p35	p35	p36	p36	p36	p36		p37	p38	p41	p45	p46	p46	p46	p46
10pF	p25	p28			p31	p35	p35	p35	p35	p36	p36	p36	p36		p37	p38	p42	p45	p46	p46	p46	p46
12pF	p25	p28			p31	p35	p35	p35	p35	p36	p36	p36	p36		p37	p39	p42	p45	p46	p46	p46	p46
15pF	p25	p28			p31	p35	p35	p35	p35	p36	p36	p36	p36		p37	p39	p42	p45	p46	p46	p46	p46
18pF	p25	p28			p31	p35		p35	p35	p36	p36	p36	p36	p36	p37	p39	p42	p45	p46	p46	p46	p46
22pF	p25	p28			p31	p35		p35	p35	p36	p36	p36	p36	p36	p37	p39	p42	p45	p46	p46	p46	p46
27pF	p25	p28			p31	p35		p35	p35	p36	p36	p36	p36	p36	p37	p39	p42	p46	p46	p46	p46	p46
33pF	p25	p28			p31	p35		p35	p35	p36	p36	p36	p36	p36	p37	p39	p42	p46			p46	p46
39pF	p25	p28			p32	p35		p35	p35	p36	p36	p36	p36	p36	p37	p39	p42	p46				
47pF	p25	p28			p32	p35		p35	p35	p36	p36	p36	p36	p36	p37	p39	p42	p46				
56pF			p28	p28	p32	p35		p35	p35	p36	p36	p36	p36	p36	p37	p39	p42	p46				
68pF			p28	p28	p32	p35		p35	p35	p36	p36	p36	p36	p36	p37	p39	p42	p46				
82pF			p28	p28	p32	p35		p35	p35	p36	p36	p36	p36	p36	p37	p39	p42	p46				
100pF			p28	p28	p32	p35		p35	p35	p36	p36	p36	p36	p36	p37	p39	p42	p46				
120pF															p37	p39	p42	p46				
150pF															p37	p39	p42	p46				
180pF															p38	p39	p42	p46				
220pF															p38	p39	p42	p46				
270pF															p38	p39	p42	p46				
330pF															p38	p39	p42	p46				
390pF															p38	p39	p42	p46				
470pF															p38	p39	p42	p46				
560pF															p38	p39	p42	p46				
680pF															p38	p39	p42	p46				
820pF																	p42	p46				
1000pF																	p42	p46				

The indication for every 0.1 pF has been omitted for less than 10 pF. Refer to the Part Number List for details.



# Capacitance Table

p00

Each number in the Part Number List refers to the page number printed at the bottom of the page.

(→ ■ GRM Series Temperature Compensating Type)

p00

← Part Number List

JIS:

CK

CJ

CH

SL

PK

PJ

PH

RK

RJ

RH

SK

SJ

SH

TK

TJ

TH

UK

UJ

EIA:

C0G

P2H

R2H

S2H

T2H

U2J

LxW (mm)	1.0x0.5										1.6x0.8												
	0.55										0.5					0.9							
	50					10					50			100		50			10				
Cap. / TC Code	S2H	SΔ	T2H	TΔ	UΔ	SL	U2J	UJ	SL	U2J	UJ	SL	U2J	UJ	C0G	CΔ	C0G	CΔ	SL	U2J	UJ	SL	
0.5pF															p48	p51	p55	p58					
1.0pF	p46	p47	p47	p47	p47										p48	p51	p55	p58					
2.0pF	p46	p47	p47	p47	p47										p48	p52	p55	p58					
3.0pF	p46	p47	p47	p47	p47										p49	p52	p55	p59					
4.0pF	p46	p47	p47	p47	p47										p49	p52	p55	p59					
5.0pF	p46	p47	p47	p47	p47										p49	p52	p56	p59					
6.0pF	p46	p47	p47	p47	p47										p49	p53	p56	p59					
7.0pF	p47	p47	p47	p47	p47										p50	p53	p56	p60					
8.0pF	p47	p47	p47	p47	p47										p50	p54	p57	p60					
9.0pF	p47	p47	p47	p47	p47										p51	p54	p57	p61					
10pF	p47	p47	p47	p47	p47										p51	p54	p58	p61					
12pF	p47	p47	p47	p47	p47										p51	p54	p58	p61					
15pF	p47	p47	p47	p47	p47										p51	p54	p58	p61					
18pF	p47	p47	p47	p47	p47										p51	p54	p58	p61					
22pF	p47	p47	p47	p47	p47										p51	p54	p58	p61					
27pF	p47	p47	p47	p47	p47										p51	p54	p58	p61					
33pF	p47	p47	p47	p47	p47										p51	p54	p58	p61					
39pF	p47	p47	p47	p47	p47										p51	p54	p58	p61					
47pF			p47	p47	p47										p51	p54	p58	p61					
56pF			p47	p47	p47										p51	p54	p58	p61					
68pF			p47	p47	p47										p51	p54	p58	p61					
82pF			p47	p47	p47										p51	p54	p58	p61					
100pF			p47	p47	p47										p51	p54	p58	p61					
120pF					p47										p51	p54	p58	p61					
150pF					p47										p51	p54	p58	p61					
180pF					p47										p51	p54	p58	p61					
220pF															p51	p54	p58	p61					
270pF															p51	p54	p58	p61					
330pF															p51	p54	p58	p61					
390pF															p51	p54	p58	p61					
470pF															p51	p54	p58	p61					
560pF															p51	p54	p58	p61					
680pF															p51	p54	p58	p61					
820pF															p51	p54	p58	p61					
1000pF															p51	p54	p58	p61					p61
1200pF						p47	p47	p48							p51	p54	p58	p61	p61	p61	p61		
1500pF						p47	p47	p48							p51	p55	p58	p61	p61	p61	p61		
1800pF						p47	p47	p48									p58	p61	p61	p61	p61		
2200pF						p47	p48	p48	p48	p48	p48						p58	p61	p61	p61	p61		
2700pF						p47	p48	p48	p48	p48	p48						p58	p61	p61	p61	p61		
3300pF						p47	p48	p48	p48	p48	p48						p58	p61	p61	p61	p61		
3900pF						p47	p48	p48	p48	p48	p48						p58	p61	p61	p61	p61		
4700pF						p47	p48	p48	p48	p48	p48								p61	p61	p61		
5600pF												p48	p48	p48					p61	p61	p62		
6800pF												p48	p48	p48					p61	p61	p62		
8200pF												p48	p48	p48					p61	p61	p62		
10000pF												p48	p48	p48					p61	p61	p62		
12000pF																							p62
15000pF																							p62
18000pF																							p62
22000pF																							p62

The indication for every 0.1 pF has been omitted for less than 10 pF. Refer to the Part Number List for details.



# Capacitance Table p00 Each number in the Part Number List refers to the page number printed at the bottom of the page.

(→ ■ GRM Series Temperature Compensating Type)

p00 ← Part Number List    JIS: CK CJ CH SL PK PJ PH RK RJ RH SK SJ SH TK TJ TH UK UJ  
 EIA: C0G P2H R2H S2H T2H U2J

LxW (mm)	1.6x0.8		2.0x1.25																				
	0.9		0.7						0.95						1								
Rated Voltage (Vdc)	10		100		50				50				10		250		50						
Cap. / TC Code	U2J	UJ	C0G	CH	C0G	CH	SL	U2J	UJ	C0G	CH	SL	U2J	UJ	SL	U2J	UJ	C0G	U2J	SL	U2J	UJ	
10pF																		p136					
12pF																		p136					
15pF																		p136					
18pF																		p136					
22pF																		p136					
27pF																		p136					
33pF																		p136					
39pF																		p136					
47pF																		p136					
56pF																		p136					
68pF																		p136					
82pF																		p136					
100pF			p62	p62														p136	p137				
120pF			p62	p62														p136	p137				
150pF			p62	p62														p136	p137				
180pF			p62	p62														p136	p137				
220pF			p62	p62														p136	p137				
270pF			p62	p62														p136	p137				
330pF			p62	p62														p136	p137				
390pF			p62	p62															p137				
470pF			p62	p62															p137				
560pF			p62	p62															p137				
680pF			p62	p62															p137				
820pF			p62	p62															p137				
1000pF			p62	p62															p137				
1200pF			p62	p62	p62	p62													p138				
1500pF			p62	p62	p62	p62													p138				
1800pF			p62	p62	p62	p62													p138				
2200pF			p62	p62	p62	p62													p138				
2700pF			p62	p62	p62	p62																	
3300pF			p62	p62	p62	p62																	
3900pF					p62	p62																	
4700pF					p62	p62																	
5600pF										p62	p62												
6800pF										p62	p62												
8200pF										p62	p62												
10000pF										p62	p62	p62											
12000pF	p62	p62					p62	p62	p62	p62	p62												
15000pF	p62	p62					p62	p62	p62	p62	p62												
18000pF	p62	p62					p62	p62	p62														
22000pF	p62	p62													p62	p62	p62						
27000pF															p62	p62	p62						
33000pF																				p62	p62	p63	
39000pF																							
47000pF																							
56000pF																		p62	p62	p62			





# Capacitance Table p00 Each number in the Part Number List refers to the page number printed at the bottom of the page.

(→ ■ GRM Series Temperature Compensating Type)

p00 ← Part Number List   
 JIS: CK CJ CH SL PK PJ PH RK RJ RH SK SJ SH TK TJ TH UK UJ  
 EIA: C0G P2H R2H S2H T2H U2J

LxW (mm)	2.0x1.25									3.2x1.6														
	1.35						1.45			0.95						1								
Rated Voltage (Vdc)	50					10			250	100		50				2000	1000		630		250			
Cap. / TC Code	C0G	CH	SL	U2J	UJ	SL	U2J	UJ	U2J	C0G	CH	C0G	CH	SL	U2J	UJ	U2J	C0G	U2J	C0G	U2J	U2J		
10pF																		p139	p137	p139	p136	p138		
12pF																			p139	p137	p139	p136	p138	
15pF																			p139	p137	p139	p136	p138	
18pF																			p139	p137	p139	p136	p138	
22pF																			p139	p137	p139	p137	p138	
27pF																			p139	p137	p139	p137	p138	
33pF																			p139	p137	p139	p137	p138	
39pF																			p139	p137	p139	p137	p138	
47pF																			p139	p137	p139	p137	p138	
56pF																			p139	p137	p139	p137	p138	
68pF																			p139	p137	p139	p137	p138	
82pF																				p137	p139	p137	p138	
100pF																				p137	p139	p137	p138	
120pF																				p137	p139	p137	p138	
150pF																				p137	p139	p137	p138	
180pF																				p137	p139	p137	p138	
220pF																				p137	p139	p137	p138	
270pF																					p139	p137	p138	
330pF																					p139	p137	p138	
390pF																						p137	p138	
470pF																						p137	p138	
560pF																						p137	p138	
680pF																							p138	
820pF																							p138	
1000pF																							p138	
1200pF																							p138	
1500pF																							p138	
1800pF											p63	p63											p138	
2200pF											p63	p63											p138	
2700pF										p138	p63	p63												p138
3300pF										p138	p63	p63												p138
3900pF										p138	p63	p63												p138
4700pF										p138	p63	p63												p138
5600pF										p138	p63	p63												p138
6800pF											p63	p63												
8200pF											p63	p63												
10000pF											p63	p63												
12000pF											p63	p63	p63	p63										
15000pF											p63	p63	p63	p63										
18000pF	p63	p63									p63	p63	p63	p63										
22000pF	p63	p63									p63	p63	p63	p63										
27000pF													p63	p63										
33000pF													p63	p63										
39000pF			p63	p63	p63								p63	p63										
47000pF			p63	p63	p63																			
56000pF															p63	p63	p63							
68000pF						p63	p63	p63																
82000pF						p63	p63	p63																
0.1μF						p63	p63	p63																

# Capacitance Table

p00

Each number in the Part Number List refers to the page number printed at the bottom of the page.

(→ ■ GRM Series Temperature Compensating Type)

p00

← Part Number List

- JIS: CK CJ CH SL PK PJ PH RK RJ RH SK SJ SH TK TJ TH UK UJ
- EIA: C0G P2H R2H S2H T2H U2J

LxW (mm)	3.2x1.6										3.2x2.5													
T max. (mm)	1.25					1.8					1		1.25		1.5		2							
Rated Voltage (Vdc)	1000	630		250	50					1000	630	50		2000	630	2000	1000	630	1000	630	1000	630		
Cap. / TC Code	U2J	C0G	U2J	U2J	C0G	CH	SL	U2J	UJ	U2J	U2J	C0G	CH	U2J	U2J	U2J	U2J	U2J	U2J	U2J	U2J	U2J	U2J	U2J
82pF														p140										
100pF														p140										
120pF														p140										
150pF														p140										
180pF																p140								
220pF																p140								
270pF																								
330pF																								
390pF	p139																							
470pF	p139																							
560pF	p139																							
680pF	p139	p137																						
820pF		p137								p139														
1000pF		p137								p139														
1200pF																p138		p139						
1500pF																p138			p139					
1800pF																p138							p139	
2200pF																p138							p139	
2700pF			p138																					
3300pF			p138																					
3900pF												p138												
4700pF												p138												
5600pF																		p138						
6800pF																							p138	
8200pF																								p138
10000pF																								p138
12000pF																								
15000pF																								
18000pF																								
22000pF																								
27000pF																								
33000pF																								
39000pF																								
47000pF						p63	p63																	
56000pF						p63	p63																	
68000pF							p63	p63	p63							p63	p63							
82000pF							p63	p63	p63							p63	p63							
0.1μF							p63	p63	p63							p63	p63							



# Capacitance Table p00 Each number in the Part Number List refers to the page number printed at the bottom of the page.

(→ ■ GRM Series Temperature Compensating Type)

p00 ← Part Number List    JIS: CK CJ CH SL PK PJ PH RK RJ RH SK SJ SH TK TJ TH UK UJ  
 EIA: C0G P2H R2H S2H T2H U2J

LxW (mm)	4.5x2.0	4.5x3.2				5.7x5.0			
	T max. (mm)	1	1.5	2	1.5	2	1.5	2	
Rated Voltage (Vdc)	3150	1000	630	1000	630	1000	630	1000	630
Cap. / TC Code	U2J	U2J	U2J	U2J	U2J	U2J	U2J	U2J	U2J
27pF	p140								
33pF	p140								
39pF	p140								
47pF	p140								
56pF	p140								
68pF	p140								
82pF	p140								
100pF	p140								
120pF									
150pF									
180pF									
220pF									
270pF									
330pF									
390pF									
470pF									
560pF									
680pF									
820pF									
1000pF									
1200pF									
1500pF									
1800pF									
2200pF									
2700pF	p139								
3300pF	p139								
3900pF			p139						
4700pF			p139						
5600pF					p139				
6800pF					p139				
8200pF							p139		
10000pF							p139		
12000pF		p139							
15000pF			p139						
18000pF			p139						
22000pF			p139						
27000pF						p139			
33000pF									p139
39000pF									p139
47000pF									p139

# Capacitance Table

p00

Each number in the Part Number List refers to the page number printed at the bottom of the page.

## ■ GRM Series High Dielectric Constant Type

p00

← Part Number List

JIS:

R

B

EIA:

X7R

X7S

X7T

X7U

X6S

X6T

X5R

X5S

LxW (mm)	0.4x0.2				0.6x0.3										1.0x0.5								
T max. (mm)	0.22				0.33										0.22								
Rated Voltage (Vdc)	10		6.3	4	50		25		16		10		6.3		4	10	6.3	4	2.5				
Cap. / TC Code	X7R	X5R, B	X5R, B	X5R	X7R	B	X7R, R	X5R, B	X7R, R	X5R, B	X7R, R	X5R, B	X7R, R	X6S	X5R, B	X6S	X5R, B	X6S	X5R, B	X7T	X6Δ	X7T	
68pF	p64	p64	p64																				
100pF	p64	p64	p64		p65	p65	p65	p65	p65	p65													
150pF	p64	p64	p64		p65	p65	p65	p65	p65	p65													
220pF	p64	p64	p64		p65	p65	p65	p65	p65	p65													
330pF	p64	p64	p64		p65	p65	p65	p65	p65	p65													
470pF	p64	p64	p64		p65	p65	p65	p65	p65	p65													
680pF		p64	p64	p64	p64		p65	p65	p65	p65	p65												
1000pF		p64	p64	p64	p64		p65	p65	p65	p65	p65												
1500pF		p64	p64	p64	p64		p65	p65	p65	p65	p65												
2200pF		p64	p64	p64	p64				p65	p65	p65	p65	p65										
3300pF		p64	p64	p64	p64				p65	p65	p65	p65	p65										
4700pF		p64	p64	p64	p64						p65	p65	p65	p66	p66	p66		p66					
6800pF		p64	p64	p64	p64						p65	p65	p66	p66	p66	p66		p66					
10000pF		p64	p64	p64	p64				p65	p65	p65	p65	p66	p66	p66	p66		p66	p66				
12000pF													p66	p66									
15000pF			p64	p64									p66	p66		p66	p66	p66					
18000pF													p66	p66									
22000pF			p64	p64									p66	p66		p66	p66	p66					
27000pF													p66	p66									
33000pF			p64	p64									p66	p66		p66	p66	p66					
39000pF													p66	p66									
47000pF			p64	p64									p66	p66		p66	p66	p66					
68000pF			p64	p64									p66	p66		p66							
0.1μF			p64	p64						p65	p65		p66	p66		p66		p66	p66	p67	p67	p67	p67
0.15μF																							
0.22μF													p66		p66	p66	p66	p66	p66	p67	p67	p67	p67
0.33μF																							
0.47μF																				p67	p67		p67
0.68μF																							
1.0μF																							
2.2μF																							
4.7μF																							
10μF																							
22μF																							
47μF																							
100μF																							
150μF																							



# Capacitance Table

p00

Each number in the Part Number List refers to the page number printed at the bottom of the page.

(→ ■ GRM Series High Dielectric Constant Type)

p00 ← Part Number List    JIS: R B    EIA: X7R X7S X7T X7U X6S X6T X5R X5S

LxW (mm)	1.0x0.5																								
	0.3						0.33						0.55												
T max. (mm)	0.3						0.33						0.55												
Rated Voltage (Vdc)	50		25		16		10		10		6.3		4		100		50		25		16		10		
Cap. / TC Code	X7R, R	B	X7R	B	X7R	B	X5R	X5R, B	X6T	X5R, B	X6T	X5R	X7R	X7Δ, R	X6S	X5R, B	X7R, R	X6S	X5R, B	X7R, R	X5R, B	X7R, R	X5R, B	X7R, R	
68pF																									
100pF																									
150pF																									
220pF	p67	p67											p67	p67	p68		p68								
330pF	p67	p67											p67	p67	p68		p68								
470pF	p67	p67											p67	p67	p68		p68								
680pF	p67	p67											p67	p67	p68		p68								
1000pF	p67	p67											p67	p67	p68		p68	p68							
1500pF	p67	p67											p67	p67	p68		p68								
2200pF			p67	p67									p67	p67	p68		p68	p68							
3300pF					p67	p67							p67	p67	p68		p68								
4700pF					p67	p67							p67	p67	p68		p68	p68					p68		
6800pF					p67	p67								p67	p68		p68	p68	p68				p68		
10000pF					p67	p67								p67	p68		p68	p68	p68				p68		
12000pF																									
15000pF							p67							p67		p68	p68	p68				p68			
18000pF																									
22000pF							p67							p67		p68	p68	p68				p68			
27000pF																									
33000pF							p67							p67		p68	p68	p68				p68	p68	p68	p69
39000pF																									
47000pF																									
68000pF																									
0.1μF																									
0.15μF																									
0.22μF																									
0.33μF																									
0.47μF																									
0.68μF																									
1.0μF																									
2.2μF																									
4.7μF																									
10μF																									
22μF																									
47μF																									
100μF																									
150μF																									



# Capacitance Table

p00

Each number in the Part Number List refers to the page number printed at the bottom of the page.

(→ ■ GRM Series High Dielectric Constant Type)

p00 ← Part Number List    JIS: **R**   **B**    EIA: **X7R**   **X7S**   **X7T**   **X7U**   **X6S**   **X6T**   **X5R**   **X5S**

LxW (mm)	1.0x0.5										1.6x0.8																	
	0.55				0.55, 0.6	0.6, 0.7	0.6	0.7		0.5		0.9						0.9, 0.95, 1										
T max. (mm)																												
Rated Voltage (Vdc)	10		6.3		4		6.3	4	2.5		2.5		25	16	250		100		50		25			16	6.3	2.5	25	
Cap. / TC Code	X6S	X5R, B	X7R	X6S	X7R	X6Δ	X5R, B	X5R, B	X6T	X5R	X5R, B	X5R, B	X7R	X7R	X7R, R	X5R, B	X7R, R	X6S	X7Δ, R	X6S	X6S	X6S	X5R, B	X5R, B	X5R, B	X5R, B	X5R, B	
68pF																												
100pF																												
150pF																												
220pF																												
330pF																												
470pF																												
680pF																												
1000pF																												
1500pF																												
2200pF																												0.9 p71
3300pF																												0.9 p71
4700pF																												0.9 p71
6800pF																												0.9 p71
10000pF																												0.9 p71
12000pF																												0.9 p71
15000pF																												0.9 p71
18000pF																												0.9 p71
22000pF																												0.9 p71
27000pF																												0.9 p71
33000pF																												0.9 p71
39000pF																												0.9 p71
47000pF																												0.9 p71
68000pF																												0.9 p71
0.1μF																												0.9 p71
0.15μF		p69	p69				p69																					0.9 p71
0.22μF		p69	p69				p69																					0.9 p71
0.33μF		p69	p69				p69																					0.9 p71
0.47μF		p69	p69				p69																					0.9 p71
0.68μF		p69	p69																									0.9 p71
1.0μF		p69		p69			p69																					0.9 p71
2.2μF		p69	p69				p69																					0.9 p71
4.7μF																												0.95, 1 p72
10μF																												1 p72
22μF																												
47μF																												
100μF																												
150μF																												



# Capacitance Table

p00

Each number in the Part Number List refers to the page number printed at the bottom of the page.

(→ ■ GRM Series High Dielectric Constant Type)

p00

← Part Number List

JIS:

R

B

EIA:

X7R

X7S

X7T

X7U

X6S

X6T

X5R

X5S

LxW (mm)	1.6x0.8										2.0x1.25												
	0.9, 0.95, 1		0.9, 1						0.9, 0.95	1	0.7		0.95										
T max. (mm)	16		16		10		6.3		4		10	35	25	16	100	50	35	25			16		
Rated Voltage (Vdc)	16		16		10		6.3		4		10	35	25	16	100	50	35	25			16		
Cap. / TC Code	X5R, B	X6S	X7Δ	X6S	X7Δ	X5R, B	X6S	X5R, B	X5R, B	X5R	X5R	X6S	X7R	X5R, B	X6S	X5R	X7R	R	X6S	X5R	B	X7R	
68pF																							
100pF																							
150pF																							
220pF																							
330pF																							
470pF																							
680pF																							
1000pF																							
1500pF																							
2200pF																							
3300pF																							
4700pF																							
6800pF																							
10000pF																							
12000pF																							
15000pF																							
18000pF																							
22000pF																							
27000pF																							
33000pF																							
39000pF																							
47000pF																							
68000pF																							
0.1μF																							
0.15μF																							
0.22μF																							
0.33μF																							
0.47μF																							
0.68μF																							
1.0μF																							
2.2μF																							
4.7μF																							
10μF																							
22μF																							
47μF																							
100μF																							
150μF																							





# Capacitance Table p00 Each number in the Part Number List refers to the page number printed at the bottom of the page.

(→ ■ GRM Series High Dielectric Constant Type)

p00 ← Part Number List    JIS: R B    EIA: X7R X7S X7T X7U X6S X6T X5R X5S

LxW (mm)	2.0x1.25																					
T max. (mm)	0.95												0.95, 1		1		1.35					
Rated Voltage (Vdc)	16				10				6.3				4		50	250	100	100	50	25		16
Cap. / TC Code	R	X6S	X5R	B	X7Δ	X5R	B	X6S	X5R	B	X6S	X5R	X7R, R	X7R	X7R	X7R	X7R, R	X5R, B	X7R, R	X6S	X5R, B	X7R
68pF																						
100pF																						
150pF																						
220pF																						
330pF																						
470pF																						
680pF																						
1000pF																						
1500pF																						
2200pF																						
3300pF																						
4700pF																						
6800pF																						
10000pF																						
12000pF																						
15000pF																						
18000pF																						
22000pF																						
27000pF																						
33000pF																						
39000pF																						
47000pF																						
68000pF																						
0.1μF																						
0.15μF																						
0.22μF																						
0.33μF																						
0.47μF																						
0.68μF	<span style="background-color: yellow;">p72</span>																					
1.0μF																						
2.2μF																						
4.7μF																						
10μF																						
22μF																						
47μF																						
100μF																						
150μF																						



# Capacitance Table

p00

Each number in the Part Number List refers to the page number printed at the bottom of the page.

(→ ■ GRM Series High Dielectric Constant Type)

p00

← Part Number List

JIS:

R

B

EIA:

X7R

X7S

X7T

X7U

X6S

X6T

X5R

X5S

LxW (mm)	2.0x1.25																						
T max. (mm)	1.35				1.4												1.45						
Rated Voltage (Vdc)	16		10	6.3	100	50	25		16		10		6.3		4		250	25	6.3	4			
Cap. / TC Code	X6S	X5R, B	X6S	X6S	X7R	X5R, B	X7R, R	X5R, B	X7R	X6S	X7R	B	X7R	X6S	X5R, B	X7U	X6S	X7R	X5R	X5R, B	X6S	X5R, B	
68pF																							
100pF																							
150pF																							
220pF																							
330pF																							
470pF																							
680pF																							
1000pF																							
1500pF																							
2200pF																							
3300pF																							
4700pF																							
6800pF																							
10000pF																							
12000pF																							
15000pF																							
18000pF																							
22000pF																							
27000pF																							
33000pF																							
39000pF																							
47000pF																							
68000pF																							
0.1μF																							
0.15μF																							
0.22μF																							
0.33μF																							
0.47μF																							
0.68μF																							
1.0μF																							
2.2μF																							
4.7μF																							
10μF																							
22μF																							
47μF																							
100μF																							
150μF																							



# Capacitance Table

p00

Each number in the Part Number List refers to the page number printed at the bottom of the page.

(→ ■ GRM Series High Dielectric Constant Type)

p00

← Part Number List

JIS:

R

B

EIA:

X7R

X7S

X7T

X7U

X6S

X6T

X5R

X5S

LxW (mm)	3.2x1.6																						
T max. (mm)	0.7		0.95									1.25						1.25, 1.3		1.8			
Rated Voltage (Vdc)	25	16	100	50	35	25	16	10	6.3	1000	630	250	50	16	100	25	630						
Cap. / TC Code	X5R, B	X6S	X7R	X7R	X5R	X7R, R	B	X6S	X5R, B	X5R, B	X6S	X5R, B	X7R	X7R	X7R	X7R, R	B	X6S	B	X7R	X5R, B	X7R	
68pF																							
100pF																							
150pF																							
220pF																							
330pF																							
470pF																							
680pF																							
1000pF																							
1500pF																							
2200pF																							
3300pF																							
4700pF																							
6800pF																							
10000pF																							
12000pF																							
15000pF																							
18000pF																							
22000pF																							
27000pF																							
33000pF																							
39000pF																							
47000pF																							
68000pF																							
0.1μF																							
0.15μF																							
0.22μF																							
0.33μF																							
0.47μF																							
0.68μF																							
1.0μF																							
2.2μF																							
4.7μF																							
10μF																							
22μF																							
47μF																							
100μF																							
150μF																							



# Capacitance Table p00 Each number in the Part Number List refers to the page number printed at the bottom of the page.

(→ ■ GRM Series High Dielectric Constant Type)

p00 ← Part Number List    JIS: R B    EIA: X7R X7S X7T X7U X6S X6T X5R X5S

LxW (mm)	3.2x1.6																	3.2x2.5					
	1.8												1.8, 1.9				1.9	1					
T max. (mm)	1.8												1.8, 1.9				1.9	1					
Rated Voltage (Vdc)	250	50		25		16		10		6.3		100	6.3	4		4	6.3	4					
Cap. / TC Code	X7R	X7R	X5R, B	X7R	X6S	X5R, B	X7R, R	X6S	X5R, B	X7R	X6S	X5R, B	X7Δ	X7R	X6Δ	X5R, B	X7U	X6Δ	X5R	X5S	X6T	X5S	
68pF																							
100pF																							
150pF																							
220pF																							
330pF																							
470pF																							
680pF																							
1000pF																							
1500pF																							
2200pF																							
3300pF																							
4700pF																							
6800pF																							
10000pF																							
12000pF																							
15000pF																							
18000pF																							
22000pF																							
27000pF																							
33000pF	p143																						
39000pF																							
47000pF	p143																						
68000pF																							
0.1μF	p143																						
0.15μF																							
0.22μF																							
0.33μF																							
0.47μF																							
0.68μF																							
1.0μF																1.8 p74							
2.2μF	p74	p74	p74													1.9 p74							
4.7μF	p74	p74	p74				p74	p74															
10μF			p74	p74	p74	p74	p74		p74	p74													
22μF						p74	p74		p74	p74	p74	p74	p74			1.8 p74							
47μF													p74	p74	p74	1.8 p74	1.8 p74	1.8 p74	1.8 p74	1.8 p74			
100μF																1.9 p74	1.9 p74	1.9 p74	1.9 p74	1.9 p74	p74		
150μF																					p75	p75	p75



# Capacitance Table

p00

Each number in the Part Number List refers to the page number printed at the bottom of the page.

(→ ■ GRM Series High Dielectric Constant Type)

p00

← Part Number List

JIS:

R

B

EIA:

X7R

X7S

X7T

X7U

X6S

X6T

X5R

X5S

LxW (mm)	3.2x2.5																						
T max. (mm)	1	1.5					1.8	2			2.2	2.7											
Rated Voltage (Vdc)	2.5	1000	630	250	50	10	100	1000	630	250	25	100	50	35	25			16					
Cap. / TC Code	X6T	X7R	X7R	X7R	X7R	B	X6S	X7R	X7R	X7R	X7R	X6S	X7R	X7R	X5R, B	X7R	X5R, B	X7R	X6S	X5R, B	X7R		
68pF																							
100pF																							
150pF																							
220pF																							
330pF																							
470pF																							
680pF																							
1000pF																							
1500pF																							
2200pF																							
3300pF																							
4700pF																							
6800pF		p144																					
10000pF		p144																					
12000pF																							
15000pF										p144													
18000pF																							
22000pF			p144							p144													
27000pF																							
33000pF										p144													
39000pF																							
47000pF										p144													
68000pF				p143																			
0.1μF																							
0.15μF				p143																			
0.22μF																							
0.33μF																							
0.47μF																							
0.68μF					p75	p75				p75													
1.0μF										p75													
2.2μF															p75								
4.7μF																p75	p75						
10μF																p75	p75	p75	p75	p75	p75		
22μF																							
47μF																							
100μF																							
150μF		p75																					



# Capacitance Table p00 Each number in the Part Number List refers to the page number printed at the bottom of the page.

(→ ■ GRM Series High Dielectric Constant Type)

p00 ← Part Number List    JIS: R B    EIA: X7R X7S X7T X7U X6S X6T X5R X5S

LxW (mm)	3.2x2.5									4.5x3.2					5.7x5.0				
T max. (mm)	2.7									1.5		2			2				
Rated Voltage (Vdc)	16			10			6.3			4		630	250	1000	630	250	1000	630	250
Cap. / TC Code	X6S	X5R, B	X7R	X6S	X5R, B	X7Δ	X6S	X5R, B	X7U	X6S	X7R	X7R	X7R	X7R	X7R	X7R	X7R	X7R	X7R
68pF																			
100pF																			
150pF																			
220pF																			
330pF																			
470pF																			
680pF																			
1000pF																			
1500pF																			
2200pF																			
3300pF																			
4700pF																			
6800pF																			
10000pF																			
12000pF																			
15000pF																			
18000pF																			
22000pF																			
27000pF																			
33000pF																			
39000pF																			
47000pF																			
68000pF																			
0.1μF																			
0.15μF																			
0.22μF																			
0.33μF																			
0.47μF																			
0.68μF																			
1.0μF																			
2.2μF																			
4.7μF																			
10μF																			
22μF																			
47μF																			
100μF																			
150μF																			

# Capacitance Table

## ■ GNM Series High Dielectric Constant Type

p00 ← Part Number List    JIS: R B    EIA: X7R X5R

Number of Elements	2																						
LxW (mm)	0.9x0.6								1.37x1.0														
T max. (mm)	0.5								0.55						0.7								
Rated Voltage (Vdc)	16		10		4		16		10		50				25				16				
Cap. / TC Code	X5R	B	X5R	B	X5R	B	X7R	R	X5R	B	X5R	B	X7R	R	X5R	B	X7R	R	X5R	B	X7R	R	
470pF																							
1000pF															p77	p77	p77	p77					
2200pF																	p77	p77	p77	p77			
4700pF																	p77	p77	p77	p77			
10000pF	p77	p77	p77	p77																			
22000pF	p77	p77	p77	p77																		p77	p77
47000pF	p77	p77	p77	p77																		p77	p77
0.1μF	p77	p77	p77	p77			p77	p77		p77												p77	p77
0.22μF																							
0.47μF																							
1.0μF					p77	p77			p77		p77	p77											
2.2μF																							



Number of Elements	2												4										
LxW (mm)	1.37x1.0												2.0x1.25										
T max. (mm)	0.7						0.8						0.55				0.7						
Rated Voltage (Vdc)	16		10		16		10		6.3		16		10		6.3		50						
Cap. / TC Code	X5R	B	X7R	R	X5R	B	X5R	B	X5R	B	X5R	B	X7R	R	B	X5R	B	X5R	B	X7R	R	B	
470pF																					p77		p77
1000pF																					p77	p77	p77
2200pF																							
4700pF																							
10000pF																							
22000pF	p77	p77	p77	p77	p77	p77																	
47000pF	p77	p77	p77	p77	p77	p77																	
0.1μF		p77			p77	p77							p77	p77	p77								
0.22μF							p77									p77	p77	p77	p77				
0.47μF																							
1.0μF							p77	p77	p77	p77						p77	p77	p77	p77				
2.2μF									p77	p77	p77	p77											



Number of Elements	4									
LxW (mm)	2.0x1.25									
T max. (mm)	0.7			0.95						
Rated Voltage (Vdc)	25			16			10		6.3	
Cap. / TC Code	X7R	R	B	X7R	R	B	X5R	B	X5R	B
470pF										
1000pF										
2200pF	p77	p77	p77							
4700pF	p77	p77	p77							
10000pF	p77	p77	p78							
22000pF				p78	p78	p78				
47000pF				p78	p78	p78				
0.1μF				p78	p78	p78				
0.22μF										
0.47μF										
1.0μF							p78	p78	p78	p78
2.2μF										



# Capacitance Table

## ■ LLL Series High Dielectric Constant Type

p00 ← Part Number List EIA: X7R X7S X6S X5R

LxW (mm)	0.5x1.0				0.8x1.6								1.25x2.0										
T max. (mm)	0.35		0.5				0.55	0.6				0.5				0.7				0.95			
Rated Voltage (Vdc)	6.3	4	25	16	10	4	4	50	25	16	10	4	50	25	16	10	6.3	4	50	25	10	16	
Cap. / TC Code	X6S	X7S	X7R	X7R	X7R	X7S	X7S	X7R	X7R	X7R	X7R	X7S	X7R	X7R	X7R	X7R	X7R	X7S	X7R	X7R	X7R	X7R	
2200pF								p80															
4700pF								p80															
10000pF			p80						p80					p80							p80		
22000pF				p80					p80					p80							p80		
47000pF				p80						p80					p80							p80	
0.1μF	p80				p80						p80					p80						p80	
0.22μF	p80					p80						p80					p80					p80	p80
0.47μF		p80										p80						p80					
1.0μF							p80												p80				
2.2μF							p80																
4.7μF																							
10μF																							



LxW (mm)	1.25x2.0		1.6x3.2																	
T max. (mm)	0.95		0.5						0.8						1.25					
Rated Voltage (Vdc)	10	4	50	25	16	10	50	25	16	10	6.3	50	25	16	10	6.3				
Cap. / TC Code	X7R	X7S	X7R	X7R	X7R	X7R	X7R	X7R	X7R	X7R	X7R	X7R	X7R	X7R	X7R	X7R	X5R			
2200pF																				
4700pF																				
10000pF			p80					p80												
22000pF			p80					p80												
47000pF				p80				p80												
0.1μF				p80				p80						p80						
0.22μF					p80				p80					p80						
0.47μF	p80					p80				p80				p80						
1.0μF	p80									p80				p80						
2.2μF		p80									p80				p80					
4.7μF																p80				
10μF																	p80			

## ■ LLR Series High Dielectric Constant Type

p00 ← Part Number List EIA: X7S

LxW (mm)	0.8x1.6			
T max. (mm)	0.55			
Rated Voltage (Vdc)	4			
TC Code	X7S			
Cap. / ESR (mΩ)	100	220	470	1000
1.0μF	p80	p80	p80	p80

# Capacitance Table

## ■ LLA Series High Dielectric Constant Type

p00 ← Part Number List EIA: X7R X7S

L×W (mm)	1.6× 0.8	2.0×1.25										3.2×1.6						
		0.55					0.95					0.55			0.95		1.25	
T max. (mm)	0.55																	
Rated Voltage (Vdc)	4	25	16	10	6.3	4	25	16	10	6.3	4	16	10	6.3	16	10	16	10
Cap. / TC Code	X7S	X7R	X7R	X7R	X7R	X7S	X7R	X7R	X7R	X7R	X7S	X7R	X7R	X7R	X7R	X7R	X7R	X7R
10000pF		p81					p81											
22000pF		p81					p81											
47000pF			p81				p81											
0.1μF	p81		p81					p81										
0.22μF	p81			p81				p81				p81						
0.47μF	p81				p81				p81				p81		p81			
1.0μF	p81					p81				p81				p81		p81	p81	
2.2μF	p81						p81				p81			p81				p81
4.7μF						p81					p81							

## ■ LLM Series High Dielectric Constant Type

p00 ← Part Number List EIA: X7R X7S

L×W (mm)	2.0×1.25				3.2×1.6		
	0.55				0.55		
Rated Voltage (Vdc)	25	16	6.3	4	16	10	6.3
Cap. / TC Code	X7R	X7R	X7R	X7S	X7R	X7R	X7R
10000pF	p81						
22000pF	p81						
47000pF		p81					
0.1μF		p81		p81			
0.22μF			p81		p81		
0.47μF			p81			p81	
1.0μF				p81			
2.2μF				p81			p81

# Capacitance Table

## ■ GJM Series Temperature Compensating Type

p00 ← Part Number List    JIS: **CK** **CJ** **CH**    EIA: **C0G** **C0H**

LxW (mm)	0.4x0.2		0.6x0.3				1.0x0.5	
T max. (mm)	0.22		0.33				0.55	
Rated Voltage (Vdc)	16		25		6.3		50	
Cap. / TC Code	C0G	CΔ	C0Δ	CΔ	C0G	CH	C0G	CΔ
0.1pF							p96	p99
0.2pF	p83	p86	p89	p92			p96	p99
1.0pF	p83	p86	p89	p92			p96	p99
2.0pF	p83	p86	p89	p92			p96	p99
3.0pF	p83	p86	p90	p93			p96	p100
4.0pF	p84	p87	p90	p93			p97	p100
5.0pF	p84	p87	p90	p93			p97	p100
6.0pF	p84	p87	p90	p94			p97	p101
7.0pF	p85	p88	p91	p94			p98	p101
8.0pF	p85	p88	p91	p94			p98	p101
9.0pF	p85	p88	p92	p95			p98	p102
10pF	p86	p89	p92	p95			p99	p102
11pF			p92	p95			p99	p102
12pF			p92	p95			p99	p102
13pF			p92	p95			p99	p102
15pF			p92	p95			p99	p102
16pF			p92	p95			p99	p102
18pF			p92	p95			p99	p102
20pF			p92	p95			p99	p102
22pF					p95	p95	p99	p102
24pF					p95	p95	p99	p102
27pF					p95	p95	p99	p102
30pF					p95	p95	p99	p102
33pF					p95	p95	p99	p102
36pF							p99	p102
39pF							p99	p102
43pF							p99	p103
47pF							p99	p103

The indication for every 0.1 pF has been omitted for less than 10 pF. Refer to the Part Number List for details.

# Capacitance Table

## ■ GQM Series Temperature Compensating Type

p00 ← Part Number List    JIS: **CK** **CJ** **CH**    EIA: **C0G**

LxW (mm)	1.6x0.8					2.0x1.25					2.8x2.8
T max. (mm)	0.8	0.9				0.95				1	1.35
Rated Voltage (Vdc)	250	100	50			100	50			250	500
Cap. / TC Code	C0G	C0G	CΔ	C0G	CH	C0G	CΔ	C0G	CH	C0G	C0G
0.1pF	p105										
0.5pF	p105	p105	p106			p108	p108			p110	p111
1.0pF	p105	p106	p106			p108	p108			p110	p111
2.0pF	p105	p106	p106			p108	p109			p110	p111
3.0pF	p105	p106	p106			p108	p109			p110	p111
4.0pF	p105	p106	p106			p108	p109			p110	p111
5.0pF	p105	p106	p106			p108	p109			p110	p111
6.0pF	p105	p106	p106			p108	p109			p110	p111
7.0pF	p105			p106	p107	p108	p109			p110	p111
8.0pF	p105			p106	p107	p108	p109			p110	p111
9.0pF	p105			p107	p107	p108	p109			p110	p111
10pF	p105			p107	p107	p108	p109			p110	p111
11pF	p105			p107	p107	p108	p109			p110	p111
12pF	p105			p107	p107	p108	p109			p110	p111
13pF	p105			p107	p107	p108	p109			p110	p112
15pF	p105			p107	p107	p108	p109			p110	p112
16pF	p105			p107	p107	p108	p109			p110	p112
18pF	p105			p107	p107	p108	p109			p110	p112
20pF	p105			p107	p107			p109	p109	p110	p112
22pF	p105			p107	p107			p109	p109	p110	p112
24pF	p105			p107	p107			p109	p109	p111	p112
27pF	p105			p107	p107			p109	p109	p111	p112
30pF	p105			p107	p107			p109	p109	p111	p112
33pF	p105			p107	p107			p109	p110	p111	p112
36pF	p105			p107	p107			p109	p110	p111	p112
39pF	p105			p107	p107			p109	p110	p111	p112
43pF	p105			p107	p107			p109	p110	p111	p112
47pF	p105			p107	p107			p109	p110	p111	p112
51pF				p107	p107			p109	p110	p111	p112
56pF				p107	p107			p109	p110	p111	p112
62pF				p107	p107			p109	p110	p111	p112
68pF				p107	p108			p109	p110	p111	p112
75pF				p107	p108			p109	p110	p111	p112
82pF				p107	p108			p109	p110	p111	p112
91pF				p107	p108			p109	p110	p111	p112
100pF				p107	p108			p109	p110	p111	p112

The indication for every 0.1 pF has been omitted for less than 10 pF. Refer to the Part Number List for details.

# Capacitance Table

## ■ GMA Series High Dielectric Constant Type

p00 ← Part Number List    JIS: R B    EIA: X7R X5R

LxW (mm)	0.38x0.38		0.5x0.5								0.8x0.8							
	0.35		0.4								0.6							
T max. (mm)	0.35		0.4								0.6							
Rated Voltage (Vdc)	10		100	25		10		6.3		100	25		10		6.3			
Cap. / TC Code	X7R	R	X7R	X7R	B	X7R	R	B	X5R	B	X7R	X7R	B	X7R	R	B	X5R	B
100pF			p114															
150pF			p114															
220pF			p114															
330pF			p114															
470pF			p114															
680pF			p114															
1000pF			p114															
1500pF				p114	p114						p114							
2200pF				p114	p114						p114							
3300pF				p114	p114						p114							
4700pF				p114	p114						p114							
6800pF						p114	p114	p114			p114							
10000pF	p114	p114				p114	p114	p114				p114	p114					
15000pF						p114	p114	p114				p114	p114					
22000pF						p114	p114	p114				p114	p114					
33000pF														p114	p114	p114		
47000pF														p114	p114	p114		
68000pF														p114	p114	p114		
0.1μF										p114	p114			p114	p114	p114		
0.47μF																	p114	p114

# Capacitance Table

## ■ GMD Series High Dielectric Constant Type

ρ00 ← Part Number List    JIS: R B    EIA: X7R X5R

LxW (mm)	0.6x0.3										1.0x0.5												
	0.33										0.55												
T max. (mm)	0.33										0.55												
Rated Voltage (Vdc)	25			16			10			6.3		50			25			16			10		
Cap. / TC Code	X7R	R	B	X7R	R	B	X7R	R	B	X5R	B	X7R	R	B	X7R	R	B	X7R	R	B	X5R	B	
100pF	p116	p116	p116																				
120pF	p116	p116	p116																				
150pF	p116	p116	p116																				
180pF	p116	p116	p116																				
220pF	p116	p116	p116									p116	p116	p117									
270pF	p116	p116	p116									p116	p117	p117									
330pF	p116	p116	p116									p116	p117	p117									
390pF	p116	p116	p116									p116	p117	p117									
470pF	p116	p116	p116									p116	p117	p117									
560pF	p116	p116	p116									p116	p117	p117									
680pF	p116	p116	p116									p116	p117	p117									
820pF	p116	p116	p116									p116	p117	p117									
1000pF	p116	p116	p116									p116	p117	p117									
1200pF	p116	p116	p116									p116	p117	p117									
1500pF	p116	p116	p116									p116	p117	p117									
1800pF				p116	p116	p116						p116	p117	p117									
2200pF				p116	p116	p116						p116	p117	p117									
2700pF				p116	p116	p116						p116	p117	p117									
3300pF				p116	p116	p116						p116	p117	p117									
3900pF							p116	p116	p116			p116	p117	p117									
4700pF							p116	p116	p116			p116	p117	p117									
5600pF							p116	p116	p116						p117	p117	p117						
6800pF							p116	p116	p116						p117	p117	p117						
8200pF							p116	p116	p116						p117	p117	p117						
10000pF							p116	p116	p116						p117	p117	p117						
12000pF															p117	p117	p117						
15000pF															p117	p117	p117						
18000pF															p117	p117	p117						
22000pF															p117	p117	p117						
27000pF															p117	p117	p117						
33000pF															p117	p117	p117						
39000pF															p117	p117	p117						
47000pF															p117	p117	p117						
56000pF										p116	p116							p117	p117	p117			
68000pF										p116	p116							p117	p117	p117			
82000pF										p116	p116							p117	p117	p117			
0.1μF										p116	p116							p117	p117	p117			
0.12μF																					p117	p117	
0.15μF																					p117	p117	
0.18μF																					p117	p117	
0.22μF																					p117	p117	
0.27μF																					p117	p117	
0.33μF																					p117	p117	
0.39μF																					p117	p117	
0.47μF																					p117	p117	

# Capacitance Table

## ■ GRJ Series High Dielectric Constant Type

p00 ← Part Number List EIA: X7R

LxW (mm)	2.0x1.25		3.2x1.6						3.2x2.5						4.5x3.2				5.7x5.0				
	T max. (mm)	1	1.45	1.25			1.8			1.5			2			1.5		2		2			
Rated Voltage (Vdc)	250	250	1000	630	250	1000	630	250	1000	630	250	1000	630	250	630	250	1000	630	250	1000	630	250	
Cap. / TC Code	X7R	X7R	X7R	X7R	X7R	X7R	X7R	X7R	X7R	X7R	X7R	X7R	X7R	X7R	X7R	X7R	X7R	X7R	X7R	X7R	X7R	X7R	X7R
470pF			p149																				
680pF			p149																				
1000pF	p148		p149	p149																			
1500pF	p148		p149	p149																			
2200pF	p148		p149	p149																			
3300pF	p148		p149	p149																			
4700pF	p148		p149	p149																			
6800pF	p148			p149		p149				p149													
10000pF		p148		p149		p149				p149													
15000pF		p148			p148		p149					p149											
22000pF		p148			p148		p149			p149			p149										
33000pF								p148				p149					p149						
47000pF								p148				p149					p149						
68000pF					p148					p148				p149							p149		
0.1μF								p148						p148			p149				p149		
0.15μF										p148					p148							p149	
0.22μF														p148						p148		p149	
0.33μF																			p148				p148
0.47μF																			p148				p148
0.68μF																							p148
1.0μF																							p148

## ■ GR3 Series High Dielectric Constant Type

p00 ← Part Number List EIA: X7T

LxW (mm)	2.0x1.25		3.2x1.6						3.2x2.5						4.5x3.2				5.7x5.0						
	T max. (mm)	1	1.45	1	1.25			1.8			1.5			2			1.5		2		2			2.7	
Rated Voltage (Vdc)	250	250	450	250	630	450	250	630	450	250	630	250	630	450	250	630	450	250	630	450	250	630	450	250	
Cap. / TC Code	X7T	X7T	X7T	X7T	X7T	X7T	X7T	X7T	X7T	X7T	X7T	X7T	X7T	X7T	X7T	X7T	X7T	X7T	X7T	X7T	X7T	X7T	X7T	X7T	X7T
10000pF	p153		p153		p154																				
15000pF	p153		p153				p154																		
22000pF		p153			p153					p154															
33000pF				p153	p153							p154													
47000pF						p153		p153					p154												
68000pF									p153					p153			p154								
0.1μF											p153			p153					p154						
0.15μF														p153			p153			p154					
0.22μF															p153					p153			p154		
0.27μF																							p154		
0.33μF																	p153								
0.47μF																			p153	p153					
0.56μF																									p153
0.68μF																						p153			
1.0μF																									p153



# Capacitance Table

## ■ GRM/DC3.15kV Series High Dielectric Constant Type

p00 ← Part Number List EIA: C0G

LxW (mm)	4.5x 2.0
T max. (mm)	1
Rated Voltage (Vdc)	3150
Cap. / TC Code	C0G
5.0pF	p158
10pF	p158
12pF	p158
15pF	p158
18pF	p158
22pF	p158
27pF	p158
33pF	p158
39pF	p158
47pF	p158

## ■ GR4 Series High Dielectric Constant Type

p00 ← Part Number List EIA: X7R

LxW (mm)	4.5x 2.0	4.5x3.2		5.7x 5.0
T max. (mm)	1.5	1.5	2	2
Rated Voltage (Vdc)	2000	2000	2000	2000
Cap. / TC Code	X7R	X7R	X7R	X7R
100pF	p161			
120pF	p161			
150pF	p161			
180pF	p161			
220pF	p161			
270pF	p161			
330pF	p161			
390pF	p161			
470pF	p161			
560pF	p161			
680pF	p161			
820pF	p161			
1000pF	p161			
1200pF	p161			
1500pF	p161			
1800pF		p161		
2200pF		p161		
2700pF		p161		
3300pF		p161		
3900pF		p161		
4700pF			p161	
10000pF				p161

## ■ GR7 Series

p00 ← Part Number List Murata Temperature Characteristic: -

LxW (mm)	2.0x1.25		3.2x1.6		
T max. (mm)	1	1.45	1	1.25	1.8
Rated Voltage (Vdc)	350	350	350	350	350
Cap. / TC Code	-	-	-	-	-
10000pF	p165		p165		
15000pF	p165		p165		
22000pF		p165	p165	p165	
27000pF		p165	p165		
33000pF			p165	p165	
47000pF					p165

## ■ GA2 Series High Dielectric Constant Type

p00 ← Part Number List EIA: X7R

LxW (mm)	4.5x 2.0	4.5x3.2		5.7x 5.0
T max. (mm)	1.5	1.5	2	2
Rated Voltage (Vac(r.m.s.))	250	250	250	250
Cap. / TC Code	X7R	X7R	X7R	X7R
470pF	p169			
1000pF	p169			
2200pF		p169		
3300pF		p169		
4700pF			p169	
10000pF		p169		
22000pF		p169		
47000pF			p169	
0.1μF				p169

## Capacitance Table

### GA3 Series UL, IEC60384-14 Class X1/Y2 Type GC High Dielectric Constant Type

ρ00 ← Part Number List    EIA: X7R

LxW (mm)	5.7×5.0
T max. (mm)	2.3
Rated Voltage (Vac(r.m.s.))	250
Cap. / TC Code	X7R
100pF	p173
150pF	p173
220pF	p173
330pF	p173

### GA3 Series IEC60384-14 Class Y2, X1/Y2 Type GF

ρ00 ← Part Number List    JIS: SL    EIA: X7R

LxW (mm)	4.5×2.0			5.7×2.8	5.7×5.0	
	1	1.5	2.2	1.5	1.5	2
Rated Voltage (Vac(r.m.s.))	250	250	250	250	250	250
Cap. / TC Code	SL	X7R	SL	X7R	X7R	X7R
10pF			p174			
12pF			p174			
15pF			p174			
18pF			p174			
22pF			p174			
27pF	p174					
33pF	p174					
39pF	p174					
47pF	p174					
56pF	p174					
68pF	p174					
82pF	p174					
100pF		p174				
150pF		p174				
220pF			p174			
330pF			p174			
470pF		p174		p174		
680pF		p174		p174		
1000pF			p174	p174		
1500pF				p175		
1800pF					p175	
2200pF					p175	
3300pF						p175
4700pF						p175

### GA3 Series IEC60384-14 Class Y3 Type GD

ρ00 ← Part Number List    JIS: SL    EIA: X7R

LxW (mm)	4.5×2.0			4.5×3.2	
	1	1.5	2.2	1.5	2
Rated Voltage (Vac(r.m.s.))	250	250	250	250	250
Cap. / TC Code	SL	X7R	SL	X7R	X7R
10pF			p176		
12pF			p176		
15pF			p176		
18pF			p176		
22pF			p176		
27pF	p176				
33pF	p176				
39pF	p176				
47pF	p176				
56pF	p176				
68pF	p176				
82pF	p176				
100pF		p176			
150pF		p176			
220pF		p176			
330pF		p176			
470pF		p176			
680pF		p176			
1000pF		p176			
1500pF		p176			
1800pF				p176	
2200pF				p176	
4700pF					p176

### GA3 Series IEC60384-14 Class X2 Type GB High Dielectric Constant Type

ρ00 ← Part Number List    EIA: X7R

LxW (mm)	5.7×5.0			
	1.5	2	2.5	2.9
Rated Voltage (Vac(r.m.s.))	250	250	250	250
Cap. / TC Code	X7R	X7R	X7R	X7R
10000pF	p177			
15000pF	p177			
22000pF		p177		
33000pF			p177	
47000pF			p177	
56000pF				p177

# Capacitance Table

## ■ KRM Series High Dielectric Constant Type

p00 ← Part Number List EIA: X7R X6S X5R

LxW (mm)	3.5x1.7						6.1x5.3													
	2		2.9		2.9	2.9	3				3.9				5		6.7			
T max. (mm)	2		2.9		2.9	2.9	3				3.9				5		6.7			
Rated Voltage (Vdc)	25	100	50	25	50	100	100	63	50	25	100	63	50	25	100	25	100	63	50	25
Cap. / TC Code	X5R	X7R	X7R	X6S	X7R	X7R	X7R	X7R	X7R	X7R	X7R	X7R	X7R	X7R	X7R	X7R	X7R	X7R	X7R	X7R
1.0μF		p200																		
2.2μF					p200	p200														
4.7μF			p200				p200	p200	p200											
6.8μF											p200									
10μF	p200			p200								p200	p200		p200					
15μF										p200								p200		
22μF														p200				p200	p200	
33μF															p200					
47μF																				p200

## ■ KR3 Series High Dielectric Constant Type

p00 ← Part Number List EIA: X7T

LxW (mm)	6.1x5.3									
	3			3.9			5	6.7		
T max. (mm)	3			3.9			5	6.7		
Rated Voltage (Vdc)	630	450	250	630	450	250	450	630	450	250
Cap. / TC Code	X7T	X7T	X7T	X7T	X7T	X7T	X7T	X7T	X7T	X7T
0.1μF	p204									
0.15μF	p204									
0.22μF		p204		p204						
0.27μF				p204						
0.47μF		p204	p204					p204		
0.56μF					p204			p204		
1.0μF						p204	p204			
1.2μF									p204	
2.2μF										p204

## ● Part Numbering

### Chip Monolithic Ceramic Capacitors

(Part Number) 

GR	M	18	8	B1	1H	102	K	A01	D
①	②	③	④	⑤	⑥	⑦	⑧	⑨	⑩

#### ① Product ID

#### ② Series

Product ID	Code	Series
<b>GR</b>	<b>J</b>	Soft Termination Type
	<b>M</b>	Tin Plated Layer
	<b>3</b>	Large Capacitance and High Allowable Ripple Current
	<b>4</b>	Only for Information Devices
	<b>7</b>	Only for Camera Flash Circuit
<b>GQ</b>	<b>M</b>	High Frequency for Flow/Reflow Soldering
<b>GM</b>	<b>A</b>	Monolithic Microchip
	<b>D</b>	For Bonding
<b>GN</b>	<b>M</b>	Capacitor Array
<b>LL</b>	<b>L</b>	Low ESL Type
	<b>R</b>	Controlled ESR Low ESL Type
	<b>A</b>	8-termination Low ESL Type
	<b>M</b>	10-termination Low ESL Type
<b>GJ</b>	<b>M</b>	High Frequency Low Loss Type
	<b>4</b>	Low Distortion Type
	<b>8</b>	Low Acoustic Type
<b>GA</b>	<b>2</b>	For AC250V (r.m.s.)
	<b>3</b>	Safety Standard Certified Type
<b>GW</b>	<b>M</b>	For Decoupling

#### ③ Dimensions (L×W)

Code	Dimensions (L×W)	EIA
<b>02</b>	0.4×0.2mm	01005
<b>03</b>	0.6×0.3mm	0201
<b>05</b>	0.5×0.5mm	0202
<b>08</b>	0.8×0.8mm	0303
<b>0D</b>	0.38×0.38mm	015015
<b>0M</b>	0.9×0.6mm	0302
<b>15</b>	1.0×0.5mm	0402
<b>18</b>	1.6×0.8mm	0603
<b>1M</b>	1.37×1.0mm	0504
<b>1U</b>	0.6×1.0mm	02404
<b>21</b>	2.0×1.25mm	0805
<b>22</b>	2.8×2.8mm	1111
<b>31</b>	3.2×1.6mm	1206
<b>32</b>	3.2×2.5mm	1210
<b>42</b>	4.5×2.0mm	1808
<b>43</b>	4.5×3.2mm	1812
<b>52</b>	5.7×2.8mm	2211
<b>55</b>	5.7×5.0mm	2220

#### ④ Dimension (T) (Except GNM)

Code	Dimension (T)
<b>2</b>	0.2mm
<b>3</b>	0.3mm
<b>4</b>	0.4mm
<b>5</b>	0.5mm
<b>6</b>	0.6mm
<b>7</b>	0.7mm
<b>8</b>	0.8mm
<b>9</b>	0.85mm
<b>A</b>	1.0mm
<b>B</b>	1.25mm
<b>C</b>	1.6mm
<b>D</b>	2.0mm
<b>E</b>	2.5mm
<b>F</b>	3.2mm
<b>M</b>	1.15mm
<b>N</b>	1.35mm
<b>Q</b>	1.5mm
<b>R</b>	1.8mm
<b>S</b>	2.8mm
<b>X</b>	Depends on individual standards.

#### ④ Elements (GNM Only)

Code	Elements
<b>2</b>	2-elements
<b>4</b>	4-elements

Continued on the following page.

Continued from the preceding page.

⑤ Temperature Characteristics

Temperature Characteristic Codes			Temperature Characteristics			Operating Temperature Range	Capacitance Change Each Temperature (%)					
Code	Public STD Code	Reference Temperature	Temperature Range	Capacitance Change or Temperature Coefficient	-55°C		-25°C		-10°C			
					Max.		Min.	Max.	Min.	Max.	Min.	
0C	CHA	*2	20°C	20 to 150°C	0±60ppm/°C	-55 to 150°C	0.82	-0.45	0.49	-0.27	0.33	-0.18
1C	CG	JIS	20°C	20 to 125°C	0±30ppm/°C	-55 to 125°C	0.54	-0.23	0.33	-0.14	0.22	-0.09
1X	SL	JIS	20°C	20 to 85°C	+350 to -1000ppm/°C	-55 to 125°C	-	-	-	-	-	-
2C	CH	JIS	20°C	20 to 125°C	0±60ppm/°C	-55 to 125°C	0.82	-0.45	0.49	-0.27	0.33	-0.18
2P	PH	JIS	20°C	20 to 85°C	-150±60ppm/°C	-25 to 85°C	-	-	1.32	0.41	0.88	0.27
2R	RH	JIS	20°C	20 to 85°C	-220±60ppm/°C	-25 to 85°C	-	-	1.7	0.72	1.13	0.48
2S	SH	JIS	20°C	20 to 85°C	-330±60ppm/°C	-25 to 85°C	-	-	2.3	1.22	1.54	0.81
2T	TH	JIS	20°C	20 to 85°C	-470±60ppm/°C	-25 to 85°C	-	-	3.07	1.85	2.05	1.23
3C	CJ	JIS	20°C	20 to 125°C	0±120ppm/°C	-55 to 125°C	1.37	-0.9	0.82	-0.54	0.55	-0.36
3P	PJ	JIS	20°C	20 to 85°C	-150±120ppm/°C	-25 to 85°C	-	-	1.65	0.14	1.1	0.09
3R	RJ	JIS	20°C	20 to 85°C	-220±120ppm/°C	-25 to 85°C	-	-	2.03	0.45	1.35	0.3
3S	SJ	JIS	20°C	20 to 85°C	-330±120ppm/°C	-25 to 85°C	-	-	2.63	0.95	1.76	0.63
3T	TJ	JIS	20°C	20 to 85°C	-470±120ppm/°C	-25 to 85°C	-	-	3.4	1.58	2.27	1.05
3U	UJ	JIS	20°C	20 to 85°C	-750±120ppm/°C	-25 to 85°C	-	-	4.94	2.84	3.29	1.89
4C	CK	JIS	20°C	20 to 125°C	0±250ppm/°C	-55 to 125°C	2.56	-1.88	1.54	-1.13	1.02	-0.75
4P	PK	JIS	20°C	20 to 85°C	-150±250ppm/°C	-25 to 85°C	-	-	2.36	-0.45	1.57	-0.3
4R	RK	JIS	20°C	20 to 85°C	-220±250ppm/°C	-25 to 85°C	-	-	2.74	-0.14	1.83	-0.09
4S	SK	JIS	20°C	20 to 85°C	-330±250ppm/°C	-25 to 85°C	-	-	3.35	0.36	2.23	0.24
4T	TK	JIS	20°C	20 to 85°C	-470±250ppm/°C	-25 to 85°C	-	-	4.12	0.99	2.74	0.66
4U	UK	JIS	20°C	20 to 85°C	-750±250ppm/°C	-25 to 85°C	-	-	5.65	2.25	3.77	1.5
5C	C0G	EIA	25°C	25 to 125°C	0±30ppm/°C	-55 to 125°C	0.58	-0.24	0.4	-0.17	0.25	-0.11
5G	X8G	*2	25°C	25 to 150°C	0±30ppm/°C	-55 to 150°C	0.58	-0.24	0.4	-0.17	0.25	-0.11
6C	C0H	EIA	25°C	25 to 125°C	0±60ppm/°C	-55 to 125°C	0.87	-0.48	0.59	-0.33	0.38	-0.21
6P	P2H	EIA	25°C	25 to 85°C	-150±60ppm/°C	-55 to 125°C	2.33	0.72	1.61	0.5	1.02	0.32
6R	R2H	EIA	25°C	25 to 85°C	-220±60ppm/°C	-55 to 125°C	3.02	1.28	2.08	0.88	1.32	0.56
6S	S2H	EIA	25°C	25 to 85°C	-330±60ppm/°C	-55 to 125°C	4.09	2.16	2.81	1.49	1.79	0.95
6T	T2H	EIA	25°C	25 to 85°C	-470±60ppm/°C	-55 to 125°C	5.46	3.28	3.75	2.26	2.39	1.44
7U	U2J	EIA	25°C	25 to 125°C *5	-750±120ppm/°C	-55 to 125°C	8.78	5.04	6.04	3.47	3.84	2.21
B1	B *1	JIS	20°C	-25 to 85°C	±10%	-25 to 85°C	-	-	-	-	-	-
B3	B	JIS	20°C	-25 to 85°C	±10%	-25 to 85°C	-	-	-	-	-	-
C3	C	JIS	20°C	-25 to 85°C	±20%	-25 to 125°C	-	-	-	-	-	-
				85 to 125°C	+15%, -30%		-	-	-	-	-	-
C6	X5S	EIA	25°C	-55 to 85°C	±22%	-55 to 85°C	-	-	-	-	-	-
C7	X7S	EIA	25°C	-55 to 125°C	±22%	-55 to 125°C	-	-	-	-	-	-
C8	X6S	EIA	25°C	-55 to 105°C	±22%	-55 to 105°C	-	-	-	-	-	-
D3	D	JIS	20°C	-25 to 125°C	+20%, -30%	-25 to 85°C	-	-	-	-	-	-
D6	X5T	EIA	25°C	-55 to 125°C	+22%, -33%	-55 to 125°C	-	-	-	-	-	-
D7	X7T	EIA	25°C	-55 to 125°C	+22%, -33%	-55 to 125°C	-	-	-	-	-	-
D8	X6T	EIA	25°C	-55 to 105°C	+22%, -33%	-55 to 105°C	-	-	-	-	-	-
E1	E (1/2Ur)	JIS	20°C	-25 to 85°C	+20%, -55%	-25 to 85°C	-	-	-	-	-	-
E4	Z5U	EIA	25°C	10 to 85°C	+22%, -56%	10 to 85°C	-	-	-	-	-	-
E7	X7U	EIA	25°C	-55 to 125°C	+22%, -56%	-55 to 125°C	-	-	-	-	-	-
F1	F *1	JIS	20°C	-25 to 85°C	+30%, -80%	-25 to 85°C	-	-	-	-	-	-
F4	Z5V	EIA	25°C	10 to 85°C	+22%, -82%	-20 to 85°C	-	-	-	-	-	-
F5	Y5V	EIA	25°C	-30 to 85°C	+22%, -82%	-30 to 85°C	-	-	-	-	-	-
J1	JA	*2	20°C	-25 to 105°C	-20% max.	-25 to 105°C	-	-	-	-	-	-
L8	X8L	*2	25°C	-55 to 150°C	+15%, -40%	-55 to 150°C	-	-	-	-	-	-

\*1 Capacitance change is specified with 50% rated voltage applied.

\*2 Murata Temperature Characteristic Code.

\*5 Rated Voltage 100Vdc max: 25 to 85°C

Continued on the following page. ↗

Please check the MURATA home page (<http://www.murata.com/>) if you cannot find the part number in the catalog.

Continued from the preceding page.

Temperature Characteristic Codes			Temperature Characteristics			Operating Temperature Range	Capacitance Change Each Temperature (%)					
Code	Public STD Code	Reference Temperature	Temperature Range	Capacitance Change or Temperature Coefficient	-55°C		-25°C		-10°C			
					Max.		Min.	Max.	Min.	Max.	Min.	
R1	R *1	JIS	20°C	-55 to 125°C	±15%	-55 to 125°C	-	-	-	-	-	-
R3	R	JIS	20°C	-55 to 125°C	±15%	-55 to 125°C	-	-	-	-	-	-
R6	X5R	EIA	25°C	-55 to 85°C	±15%	-55 to 85°C	-	-	-	-	-	-
R7	X7R	EIA	25°C	-55 to 125°C	±15%	-55 to 125°C	-	-	-	-	-	-
R8	R *1	JIS	20°C	-25 to 85°C	±15%	-25 to 85°C	-	-	-	-	-	-
R9	X8R	EIA	25°C	-55 to 150°C	±15%	-55 to 150°C	-	-	-	-	-	-
W0	-	*2	25°C	-55 to 125°C	±10% *3	-55 to 125°C	-	-	-	-	-	-
					+22%, -33% *4		-	-	-	-	-	-

\*1 Capacitance change is specified with 50% rated voltage applied.

\*2 Murata Temperature Characteristic Code.

\*3 Apply DC350V bias.

\*4 No DC bias.

⑥ Rated Voltage

Code	Rated Voltage
0E	DC2.5V
0G	DC4V
0J	DC6.3V
1A	DC10V
1C	DC16V
1E	DC25V
YA	DC35V
1H	DC50V
2A	DC100V
2D	DC200V
2E	DC250V
YD	DC300V
2W	DC450V
2H	DC500V
2J	DC630V
3A	DC1kV
3D	DC2kV
3F	DC3.15kV
BB	DC350V (for Camera Flash Circuit)
E2	AC250V
GC	X1/Y2; AC250V (Safety Standard Certified Type GC)
GF	Y2, X1/Y2; AC250V (Safety Standard Certified Type GF)
GD	Y3; AC250V (Safety Standard Certified Type GD)
GB	X2; AC250V (Safety Standard Certified Type GB)

⑦ Capacitance

Expressed by three-digit alphanumerics. The unit is picofarad (pF). The first and second figures are significant digits, and the third figure expresses the number of zeros which follow the two numbers. If there is a decimal point, it is expressed by the capital letter "R." In this case, all figures are significant digits. If any alphabet, other than "R", is included, this indicates the specific part number is a non-standard part.

Ex.)

Code	Capacitance
R50	0.5pF
1R0	1.0pF
100	10pF
103	10000pF

⑧ Capacitance Tolerance

Code	Capacitance Tolerance
B	±0.1pF
C	±0.25pF
D	±0.5pF (10pF and below)
	±0.5% (10pF and over)
F	±1%
G	±2%
J	±5%
K	±10%
M	±20%
N	±30%
R	Depends on individual standards.
W	±0.05pF
X	Depends on individual standards.
Y	Depends on individual standards.
Z	+80/-20%

⑨ Individual Specification Code (Except LLR)

Expressed by three figures.

⑩ ESR (LLR Only)

Code	ESR
E01	100mΩ
E03	220mΩ
E05	470mΩ
E07	1000mΩ

⑩ Packaging

Code	Packaging
L	ø180mm Embossed Taping
D	ø180mm Paper Taping
E	ø180mm Paper Taping (LLL15)
K	ø330mm Embossed Taping
J	ø330mm Paper Taping
F	ø330mm Paper Taping (LLL15)
B	Bulk
C	Bulk Case
T	Bulk Tray

Please check the MURATA home page (<http://www.murata.com/>) if you cannot find the part number in the catalog.

### Metal Terminal Monolithic Ceramic Capacitors

(Part Number)

KR	M	55	T	R7	2A	106	M	H01	K
①	②	③	④	⑤	⑥	⑦	⑧	⑨	⑩

① Product ID

② Series

Product ID	Code	Series
KR	M	Metal Terminal Monolithic Ceramic Capacitors (DC25V to DC100V)
KR	3	Metal Terminal Monolithic Ceramic Capacitors Large Capacitance and High Allowable Ripple Current Type (DC250V to DC630V)

③ Chip Dimension (L×W)

Code	Chip Dimension	EIA
31	3.2×1.6mm	1206
55	5.7×5.0mm	2220

⑤ Temperature Characteristics

Temperature Characteristic Codes			Temperature Characteristics			Operating Temperature Range
Code	Public STD Code		Reference Temperature	Temperature Range	Temperature Coefficient	
C8	X6S	EIA	25°C	-55 to 105°C	±22%	-55 to 105°C
D7	X7T	EIA	25°C	-55 to 125°C	+22/-33%	-55 to 125°C
R6	X5R	EIA	25°C	-55 to 85°C	±15%	-55 to 85°C
R7	X7R	EIA	25°C	-55 to 125°C	±15%	-55 to 125°C

⑥ Rated Voltage

Code	Rated Voltage
1E	DC25V
1H	DC50V
1J	DC63V
2A	DC100V
2E	DC250V
2W	DC450V
2J	DC630V

⑦ Capacitance

Expressed by three-digit alphanumerics. The unit is pico-farad (pF). The first and second figures are significant digits, and the third figure expresses the number of zeros that follow the two numbers.

Ex.)

Code	Capacitance
105	1.0μF
225	2.2μF
106	10μF
226	22μF

④ Height Dimension (T)

Code	Dimension (T)
F	1.9mm
K	2.7mm
L	2.8mm
Q	3.7mm
T	4.8mm
W	6.4mm

⑧ Capacitance Tolerance

Code	Capacitance Tolerance
K	±10%
M	±20%

⑨ Individual Specification Code

Expressed by three figures.

⑩ Package

Code	Package
K	ø330mm Embossed Taping

Please check the MURATA home page (<http://www.murata.com/>) if you cannot find the part number in the catalog.

# Contents

## Chip Monolithic Ceramic Capacitors

For General Purpose GRM Series  
 (Less than 250Vdc) ..... p21

Capacitor Array GNM Series ..... p76

Low ESL LLL/LLR/LLA/LLM Series ..... p79

High-Q Type GJM Series ..... p82

High Frequency GQM Series ..... p104

Monolithic Microchip GMA Series ..... p113

For Bonding GMD Series ..... p115

⚠Caution/Notice ..... p118

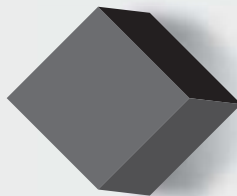
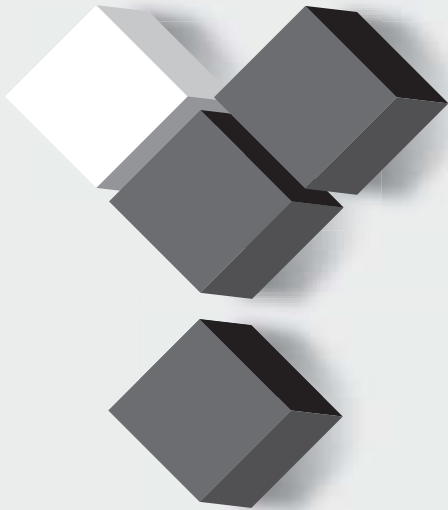

For General Purpose  
 GRM Series

Capacitor Array  
 GNM Series

Low ESL  
 LLL Series

High-Q Type  
 GJM Series

High Frequency  
 GQM Series

Monolithic Microchip  
 GMA Series

For Bonding  
 GMD Series

Product Information



# SEARCH

SPECIFICATIONS AND TEST METHODS, Package, Chart of characteristic data, please refer to the search for capacitor page WEB.

<http://www.murata.com/products/capacitor/>

The screenshot shows the Murata product page for part number GRM155R60J224ME01#. The page is divided into several sections:

- Image:** Shows a 3D model and a photograph of the capacitor component.
- Specifications & application:** A sidebar containing:
  - Rated value: 0.22 μF ±20%
  - Rated voltage: 6.3 Vdc
  - Package: 0603 (1.6 x 0.8 mm)
  - Distance between external terminals (pitch): 0.8 mm
  - Lead wire length: 0.50 mm
  - Specifications:
    - Capacitance: 0.22 μF ±20%
    - Rated voltage: 6.3 Vdc
    - Temperature characteristic (standard standard): ±20%
    - Capacitance change rate: ±1%
    - Temperature range of temperature characteristics: -55 to +125
    - Operating temperature range: -55 to +125
  - Reference:
 

Part No.	Quantity	Minimum quantity
01	10000	10000
02	50000	50000
03	100000	100000
04	200000	200000
- Chart of characteristic data:** A grid of six graphs:
  - Frequency characteristics (ESR, Impedance): Shows ESR and Impedance vs. Frequency.
  - S parameter (Smith chart S11): A Smith chart showing the reflection coefficient.
  - DC bias characteristics: Shows Capacitance vs. DC Bias Voltage.
  - AC voltage characteristics: Shows Capacitance vs. AC Voltage.
  - Capacitance - temperature characteristics: Shows Capacitance vs. Temperature.
  - Calorific property by ripple current: Shows Temperature Rise vs. Ripple Current.

## Detailed specifications sheet

- Rated value
- SPECIFICATIONS AND TEST METHODS
- Package
- Caution, Notice (Storage, Soldering and Mounting, ....etc.)

## Chart of characteristic data

- The main products published characteristic data.
- Frequency characteristics(ESR, Impedance)
  - S parameter(Smith chart S11)
  - DC bias characteristics
  - AC voltage characteristics
  - Capacitance - temperature characteristics
  - Calorific property by ripple current

## Chip Monolithic Ceramic Capacitors

# For General Purpose GRM Series (Less than 250Vdc)

The most widely used capacitor in the world!  
Ideal capacitors can be selected from an abundant lineup.

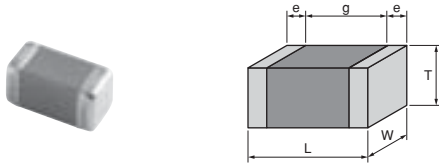

- 1 Lineup of small size and large capacity capacitors is available.
- 2 Since the external electrodes consist of a plated structure, the product is excellent in soldering heat resistance, and flow (GRM18/21/31 types only) and reflow soldering can be used.
- 3 High reliability with no polarity.
- 4 Low impedance in high frequencies, and excellent in pulse response and noise elimination.
- 5 The profile dimensions have been standardized with high precision, therefore high reliability can be acquired in the case of automatic mounting.
- 6 Paper tape or embossed tape is used for the packaging, according to the chip size.  
GRM15/18/21 (T = 0.6, 1.25) can also be supplied in bulk cases.

For General Purpose  
GRM Series

Capacitor Array  
GNM Series

Low ESL  
LL□ Series

High-Q Type  
GJM Series

High Frequency  
GQM Series

Monolithic Microchip  
GMA Series

For Bonding  
GMD Series

Product Information

# GRM Series Temperature Compensating Type Part Number List

■ 0.4x0.2mm Ultra-compact

T max.	Rated Voltage	TC Code	Cap.	Tol.	Part Number
0.22mm	16Vdc	C0G	0.2pF	±0.05pF	GRM0225C1CR20WD05#
				±0.1pF	GRM0225C1CR20BD05#
			0.3pF	±0.05pF	GRM0225C1CR30WD05#
				±0.1pF	GRM0225C1CR30BD05#
			0.4pF	±0.05pF	GRM0225C1CR40WD05#
				±0.1pF	GRM0225C1CR40BD05#
			0.5pF	±0.05pF	GRM0225C1CR50WD05#
				±0.1pF	GRM0225C1CR50BD05#
			0.6pF	±0.05pF	GRM0225C1CR60WD05#
				±0.1pF	GRM0225C1CR60BD05#
			0.7pF	±0.05pF	GRM0225C1CR70WD05#
				±0.1pF	GRM0225C1CR70BD05#
			0.8pF	±0.05pF	GRM0225C1CR80WD05#
				±0.1pF	GRM0225C1CR80BD05#
			0.9pF	±0.05pF	GRM0225C1CR90WD05#
				±0.1pF	GRM0225C1CR90BD05#
			1.0pF	±0.05pF	GRM0225C1C1R0WD05#
				±0.1pF	GRM0225C1C1R0BD05#
				±0.25pF	GRM0225C1C1R0CD05#
			1.1pF	±0.05pF	GRM0225C1C1R1WD05#
				±0.1pF	GRM0225C1C1R1BD05#
				±0.25pF	GRM0225C1C1R1CD05#
			1.2pF	±0.05pF	GRM0225C1C1R2WD05#
				±0.1pF	GRM0225C1C1R2BD05#
				±0.25pF	GRM0225C1C1R2CD05#
			1.3pF	±0.05pF	GRM0225C1C1R3WD05#
				±0.1pF	GRM0225C1C1R3BD05#
				±0.25pF	GRM0225C1C1R3CD05#
			1.4pF	±0.05pF	GRM0225C1C1R4WD05#
				±0.1pF	GRM0225C1C1R4BD05#
				±0.25pF	GRM0225C1C1R4CD05#
			1.5pF	±0.05pF	GRM0225C1C1R5WD05#
				±0.1pF	GRM0225C1C1R5BD05#
				±0.25pF	GRM0225C1C1R5CD05#
			1.6pF	±0.05pF	GRM0225C1C1R6WD05#
				±0.1pF	GRM0225C1C1R6BD05#
				±0.25pF	GRM0225C1C1R6CD05#
			1.7pF	±0.05pF	GRM0225C1C1R7WD05#
				±0.1pF	GRM0225C1C1R7BD05#
				±0.25pF	GRM0225C1C1R7CD05#
			1.8pF	±0.05pF	GRM0225C1C1R8WD05#
				±0.1pF	GRM0225C1C1R8BD05#
				±0.25pF	GRM0225C1C1R8CD05#
			1.9pF	±0.05pF	GRM0225C1C1R9WD05#
				±0.1pF	GRM0225C1C1R9BD05#
				±0.25pF	GRM0225C1C1R9CD05#
			2.0pF	±0.05pF	GRM0225C1C2R0WD05#
				±0.1pF	GRM0225C1C2R0BD05#
±0.25pF	GRM0225C1C2R0CD05#				
2.1pF	±0.05pF	GRM0225C1C2R1WD05#			
	±0.1pF	GRM0225C1C2R1BD05#			
	±0.25pF	GRM0225C1C2R1CD05#			

T max.	Rated Voltage	TC Code	Cap.	Tol.	Part Number
0.22mm	16Vdc	C0G	2.2pF	±0.05pF	GRM0225C1C2R2WD05#
				±0.1pF	GRM0225C1C2R2BD05#
				±0.25pF	GRM0225C1C2R2CD05#
			2.3pF	±0.05pF	GRM0225C1C2R3WD05#
				±0.1pF	GRM0225C1C2R3BD05#
				±0.25pF	GRM0225C1C2R3CD05#
			2.4pF	±0.05pF	GRM0225C1C2R4WD05#
				±0.1pF	GRM0225C1C2R4BD05#
				±0.25pF	GRM0225C1C2R4CD05#
			2.5pF	±0.05pF	GRM0225C1C2R5WD05#
				±0.1pF	GRM0225C1C2R5BD05#
				±0.25pF	GRM0225C1C2R5CD05#
			2.6pF	±0.05pF	GRM0225C1C2R6WD05#
				±0.1pF	GRM0225C1C2R6BD05#
				±0.25pF	GRM0225C1C2R6CD05#
			2.7pF	±0.05pF	GRM0225C1C2R7WD05#
				±0.1pF	GRM0225C1C2R7BD05#
				±0.25pF	GRM0225C1C2R7CD05#
			2.8pF	±0.05pF	GRM0225C1C2R8WD05#
				±0.1pF	GRM0225C1C2R8BD05#
				±0.25pF	GRM0225C1C2R8CD05#
			2.9pF	±0.05pF	GRM0225C1C2R9WD05#
				±0.1pF	GRM0225C1C2R9BD05#
				±0.25pF	GRM0225C1C2R9CD05#
			3.0pF	±0.05pF	GRM0225C1C3R0WD05#
				±0.1pF	GRM0225C1C3R0BD05#
				±0.25pF	GRM0225C1C3R0CD05#
			3.1pF	±0.05pF	GRM0225C1C3R1WD05#
				±0.1pF	GRM0225C1C3R1BD05#
				±0.25pF	GRM0225C1C3R1CD05#
			3.2pF	±0.05pF	GRM0225C1C3R2WD05#
				±0.1pF	GRM0225C1C3R2BD05#
				±0.25pF	GRM0225C1C3R2CD05#
			3.3pF	±0.05pF	GRM0225C1C3R3WD05#
				±0.1pF	GRM0225C1C3R3BD05#
				±0.25pF	GRM0225C1C3R3CD05#
			3.4pF	±0.05pF	GRM0225C1C3R4WD05#
				±0.1pF	GRM0225C1C3R4BD05#
				±0.25pF	GRM0225C1C3R4CD05#
			3.5pF	±0.05pF	GRM0225C1C3R5WD05#
				±0.1pF	GRM0225C1C3R5BD05#
				±0.25pF	GRM0225C1C3R5CD05#
			3.6pF	±0.05pF	GRM0225C1C3R6WD05#
				±0.1pF	GRM0225C1C3R6BD05#
				±0.25pF	GRM0225C1C3R6CD05#
			3.7pF	±0.05pF	GRM0225C1C3R7WD05#
				±0.1pF	GRM0225C1C3R7BD05#
				±0.25pF	GRM0225C1C3R7CD05#
3.8pF	±0.05pF	GRM0225C1C3R8WD05#			
	±0.1pF	GRM0225C1C3R8BD05#			
	±0.25pF	GRM0225C1C3R8CD05#			
3.9pF	±0.05pF	GRM0225C1C3R9WD05#			
	±0.1pF	GRM0225C1C3R9BD05#			
	±0.25pF	GRM0225C1C3R9CD05#			

Part number # indicates the package specification code.

For General Purpose GRM Series  
 Capacitor Array GNM Series  
 Low ESL LLI Series  
 High-Q Type GJM Series  
 High Frequency GQM Series  
 Monolithic Microchip GMA Series  
 For Bonding GMD Series  
 Product Information

## GRM Series Temperature Compensating Type Part Number List

(→ ■ 0.4x0.2mm)

T max.	Rated Voltage	TC Code	Cap.	Tol.	Part Number
0.22mm	16Vdc	C0G	4.0pF	±0.05pF	GRM0225C1C4R0WD05#
				±0.1pF	GRM0225C1C4R0BD05#
				±0.25pF	GRM0225C1C4R0CD05#
			4.1pF	±0.05pF	GRM0225C1C4R1WD05#
				±0.1pF	GRM0225C1C4R1BD05#
				±0.25pF	GRM0225C1C4R1CD05#
			4.2pF	±0.05pF	GRM0225C1C4R2WD05#
				±0.1pF	GRM0225C1C4R2BD05#
				±0.25pF	GRM0225C1C4R2CD05#
			4.3pF	±0.05pF	GRM0225C1C4R3WD05#
				±0.1pF	GRM0225C1C4R3BD05#
				±0.25pF	GRM0225C1C4R3CD05#
			4.4pF	±0.05pF	GRM0225C1C4R4WD05#
				±0.1pF	GRM0225C1C4R4BD05#
				±0.25pF	GRM0225C1C4R4CD05#
			4.5pF	±0.05pF	GRM0225C1C4R5WD05#
				±0.1pF	GRM0225C1C4R5BD05#
				±0.25pF	GRM0225C1C4R5CD05#
			4.6pF	±0.05pF	GRM0225C1C4R6WD05#
				±0.1pF	GRM0225C1C4R6BD05#
				±0.25pF	GRM0225C1C4R6CD05#
			4.7pF	±0.05pF	GRM0225C1C4R7WD05#
				±0.1pF	GRM0225C1C4R7BD05#
				±0.25pF	GRM0225C1C4R7CD05#
			4.8pF	±0.05pF	GRM0225C1C4R8WD05#
				±0.1pF	GRM0225C1C4R8BD05#
				±0.25pF	GRM0225C1C4R8CD05#
			4.9pF	±0.05pF	GRM0225C1C4R9WD05#
				±0.1pF	GRM0225C1C4R9BD05#
				±0.25pF	GRM0225C1C4R9CD05#
			5.0pF	±0.05pF	GRM0225C1C5R0WD05#
				±0.1pF	GRM0225C1C5R0BD05#
				±0.25pF	GRM0225C1C5R0CD05#
			5.1pF	±0.05pF	GRM0225C1C5R1WD05#
				±0.1pF	GRM0225C1C5R1BD05#
				±0.25pF	GRM0225C1C5R1CD05#
				±0.5pF	GRM0225C1C5R1DD05#
			5.2pF	±0.05pF	GRM0225C1C5R2WD05#
				±0.1pF	GRM0225C1C5R2BD05#
				±0.25pF	GRM0225C1C5R2CD05#
				±0.5pF	GRM0225C1C5R2DD05#
			5.3pF	±0.05pF	GRM0225C1C5R3WD05#
				±0.1pF	GRM0225C1C5R3BD05#
				±0.25pF	GRM0225C1C5R3CD05#
				±0.5pF	GRM0225C1C5R3DD05#
			5.4pF	±0.05pF	GRM0225C1C5R4WD05#
				±0.1pF	GRM0225C1C5R4BD05#
				±0.25pF	GRM0225C1C5R4CD05#
				±0.5pF	GRM0225C1C5R4DD05#
			5.5pF	±0.05pF	GRM0225C1C5R5WD05#
				±0.1pF	GRM0225C1C5R5BD05#
				±0.25pF	GRM0225C1C5R5CD05#
				±0.5pF	GRM0225C1C5R5DD05#
			5.6pF	±0.05pF	GRM0225C1C5R6WD05#

T max.	Rated Voltage	TC Code	Cap.	Tol.	Part Number
0.22mm	16Vdc	C0G	5.6pF	±0.1pF	GRM0225C1C5R6BD05#
				±0.25pF	GRM0225C1C5R6CD05#
				±0.5pF	GRM0225C1C5R6DD05#
			5.7pF	±0.05pF	GRM0225C1C5R7WD05#
				±0.1pF	GRM0225C1C5R7BD05#
				±0.25pF	GRM0225C1C5R7CD05#
			5.8pF	±0.05pF	GRM0225C1C5R8WD05#
				±0.1pF	GRM0225C1C5R8BD05#
				±0.25pF	GRM0225C1C5R8CD05#
			5.9pF	±0.05pF	GRM0225C1C5R9WD05#
				±0.1pF	GRM0225C1C5R9BD05#
				±0.25pF	GRM0225C1C5R9CD05#
			6.0pF	±0.05pF	GRM0225C1C6R0WD05#
				±0.1pF	GRM0225C1C6R0BD05#
				±0.25pF	GRM0225C1C6R0CD05#
			6.1pF	±0.05pF	GRM0225C1C6R1WD05#
				±0.1pF	GRM0225C1C6R1BD05#
				±0.25pF	GRM0225C1C6R1CD05#
			6.2pF	±0.05pF	GRM0225C1C6R2WD05#
				±0.1pF	GRM0225C1C6R2BD05#
				±0.25pF	GRM0225C1C6R2CD05#
			6.3pF	±0.05pF	GRM0225C1C6R3WD05#
				±0.1pF	GRM0225C1C6R3BD05#
				±0.25pF	GRM0225C1C6R3CD05#
			6.4pF	±0.05pF	GRM0225C1C6R4WD05#
				±0.1pF	GRM0225C1C6R4BD05#
				±0.25pF	GRM0225C1C6R4CD05#
			6.5pF	±0.05pF	GRM0225C1C6R5WD05#
				±0.1pF	GRM0225C1C6R5BD05#
				±0.25pF	GRM0225C1C6R5CD05#
			6.6pF	±0.05pF	GRM0225C1C6R6WD05#
				±0.1pF	GRM0225C1C6R6BD05#
				±0.25pF	GRM0225C1C6R6CD05#
			6.7pF	±0.05pF	GRM0225C1C6R7WD05#
				±0.1pF	GRM0225C1C6R7BD05#
				±0.25pF	GRM0225C1C6R7CD05#
			6.8pF	±0.05pF	GRM0225C1C6R8WD05#
				±0.1pF	GRM0225C1C6R8BD05#
				±0.25pF	GRM0225C1C6R8CD05#
			6.9pF	±0.05pF	GRM0225C1C6R9WD05#
				±0.1pF	GRM0225C1C6R9BD05#
				±0.25pF	GRM0225C1C6R9CD05#

Part number # indicates the package specification code.

## GRM Series Temperature Compensating Type Part Number List

(→ ■ 0.4x0.2mm)

T max.	Rated Voltage	TC Code	Cap.	Tol.	Part Number	
0.22mm	16Vdc	C0G	6.9pF	±0.5pF	GRM0225C1C6R9DD05#	
				7.0pF	±0.05pF	GRM0225C1C7R0WD05#
					±0.1pF	GRM0225C1C7R0BD05#
			±0.25pF		GRM0225C1C7R0CD05#	
			7.1pF	±0.5pF	GRM0225C1C7R0DD05#	
				±0.05pF	GRM0225C1C7R1WD05#	
				±0.1pF	GRM0225C1C7R1BD05#	
			7.2pF	±0.25pF	GRM0225C1C7R1CD05#	
				±0.5pF	GRM0225C1C7R1DD05#	
				±0.05pF	GRM0225C1C7R2WD05#	
			7.3pF	±0.1pF	GRM0225C1C7R2BD05#	
				±0.25pF	GRM0225C1C7R2CD05#	
				±0.5pF	GRM0225C1C7R2DD05#	
			7.4pF	±0.05pF	GRM0225C1C7R3WD05#	
				±0.1pF	GRM0225C1C7R3BD05#	
				±0.25pF	GRM0225C1C7R3CD05#	
			7.5pF	±0.5pF	GRM0225C1C7R3DD05#	
				±0.05pF	GRM0225C1C7R4WD05#	
				±0.1pF	GRM0225C1C7R4BD05#	
			7.6pF	±0.25pF	GRM0225C1C7R4CD05#	
				±0.5pF	GRM0225C1C7R4DD05#	
				±0.05pF	GRM0225C1C7R5WD05#	
			7.7pF	±0.1pF	GRM0225C1C7R5BD05#	
				±0.25pF	GRM0225C1C7R5CD05#	
				±0.5pF	GRM0225C1C7R5DD05#	
			7.8pF	±0.05pF	GRM0225C1C7R6WD05#	
				±0.1pF	GRM0225C1C7R6BD05#	
				±0.25pF	GRM0225C1C7R6CD05#	
			7.9pF	±0.5pF	GRM0225C1C7R6DD05#	
				±0.05pF	GRM0225C1C7R7WD05#	
				±0.1pF	GRM0225C1C7R7BD05#	
			8.0pF	±0.25pF	GRM0225C1C7R7CD05#	
				±0.5pF	GRM0225C1C7R7DD05#	
				±0.05pF	GRM0225C1C7R8WD05#	
			8.1pF	±0.1pF	GRM0225C1C7R8BD05#	
				±0.25pF	GRM0225C1C7R8CD05#	
				±0.5pF	GRM0225C1C7R8DD05#	
			8.2pF	±0.05pF	GRM0225C1C7R9WD05#	
				±0.1pF	GRM0225C1C7R9BD05#	
				±0.25pF	GRM0225C1C7R9CD05#	
			8.3pF	±0.5pF	GRM0225C1C7R9DD05#	
				±0.05pF	GRM0225C1C8R0WD05#	
				±0.1pF	GRM0225C1C8R0BD05#	
			8.4pF	±0.25pF	GRM0225C1C8R0CD05#	
				±0.5pF	GRM0225C1C8R0DD05#	
				±0.05pF	GRM0225C1C8R1WD05#	
			8.5pF	±0.1pF	GRM0225C1C8R1BD05#	
				±0.25pF	GRM0225C1C8R1CD05#	
				±0.5pF	GRM0225C1C8R1DD05#	
			8.6pF	±0.05pF	GRM0225C1C8R2WD05#	
				±0.1pF	GRM0225C1C8R2BD05#	
				±0.25pF	GRM0225C1C8R2CD05#	
			8.7pF	±0.5pF	GRM0225C1C8R2DD05#	
				±0.05pF	GRM0225C1C8R3WD05#	
±0.1pF	GRM0225C1C8R3BD05#					
8.8pF	±0.25pF	GRM0225C1C8R3CD05#				
	±0.5pF	GRM0225C1C8R3DD05#				
	±0.05pF	GRM0225C1C8R4WD05#				
8.9pF	±0.1pF	GRM0225C1C8R4BD05#				
	±0.25pF	GRM0225C1C8R4CD05#				
	±0.5pF	GRM0225C1C8R4DD05#				
9.0pF	±0.05pF	GRM0225C1C8R5WD05#				
	±0.1pF	GRM0225C1C8R5BD05#				
	±0.25pF	GRM0225C1C8R5CD05#				
9.1pF	±0.5pF	GRM0225C1C8R5DD05#				
	±0.05pF	GRM0225C1C8R6WD05#				
	±0.1pF	GRM0225C1C8R6BD05#				
9.2pF	±0.25pF	GRM0225C1C8R6CD05#				
	±0.5pF	GRM0225C1C8R6DD05#				
	±0.05pF	GRM0225C1C8R7WD05#				
9.3pF	±0.1pF	GRM0225C1C8R7BD05#				
	±0.25pF	GRM0225C1C8R7CD05#				
	±0.5pF	GRM0225C1C8R7DD05#				
9.4pF	±0.05pF	GRM0225C1C8R8WD05#				
	±0.1pF	GRM0225C1C8R8BD05#				
	±0.25pF	GRM0225C1C8R8CD05#				
9.5pF	±0.5pF	GRM0225C1C8R8DD05#				
	±0.05pF	GRM0225C1C8R9WD05#				
	±0.1pF	GRM0225C1C8R9BD05#				
9.6pF	±0.25pF	GRM0225C1C8R9CD05#				
	±0.5pF	GRM0225C1C8R9DD05#				
	±0.05pF	GRM0225C1C9R0WD05#				
9.7pF	±0.1pF	GRM0225C1C9R0BD05#				
	±0.25pF	GRM0225C1C9R0CD05#				
	±0.5pF	GRM0225C1C9R0DD05#				
9.8pF	±0.05pF	GRM0225C1C9R1WD05#				
	±0.1pF	GRM0225C1C9R1BD05#				
	±0.25pF	GRM0225C1C9R1CD05#				
9.9pF	±0.5pF	GRM0225C1C9R1DD05#				
	±0.05pF	GRM0225C1C9R2WD05#				
	±0.1pF	GRM0225C1C9R2BD05#				
10.0pF	±0.25pF	GRM0225C1C9R2CD05#				
	±0.5pF	GRM0225C1C9R2DD05#				
	±0.05pF	GRM0225C1C9R3WD05#				
10.1pF	±0.1pF	GRM0225C1C9R3BD05#				
	±0.25pF	GRM0225C1C9R3CD05#				
	±0.5pF	GRM0225C1C9R3DD05#				
10.2pF	±0.05pF	GRM0225C1C9R4WD05#				
	±0.1pF	GRM0225C1C9R4BD05#				
	±0.25pF	GRM0225C1C9R4CD05#				
10.3pF	±0.5pF	GRM0225C1C9R4DD05#				
	±0.05pF	GRM0225C1C9R5WD05#				
	±0.1pF	GRM0225C1C9R5BD05#				
10.4pF	±0.25pF	GRM0225C1C9R5CD05#				
	±0.5pF	GRM0225C1C9R5DD05#				
	±0.05pF	GRM0225C1C9R6WD05#				
10.5pF	±0.1pF	GRM0225C1C9R6BD05#				
	±0.25pF	GRM0225C1C9R6CD05#				
	±0.5pF	GRM0225C1C9R6DD05#				

T max.	Rated Voltage	TC Code	Cap.	Tol.	Part Number
0.22mm	16Vdc	C0G	8.3pF	±0.1pF	GRM0225C1C8R3BD05#
				±0.25pF	GRM0225C1C8R3CD05#
				±0.5pF	GRM0225C1C8R3DD05#
			8.4pF	±0.05pF	GRM0225C1C8R4WD05#
				±0.1pF	GRM0225C1C8R4BD05#
				±0.25pF	GRM0225C1C8R4CD05#
			8.5pF	±0.5pF	GRM0225C1C8R4DD05#
				±0.05pF	GRM0225C1C8R5WD05#
				±0.1pF	GRM0225C1C8R5BD05#
			8.6pF	±0.25pF	GRM0225C1C8R5CD05#
				±0.5pF	GRM0225C1C8R5DD05#
				±0.05pF	GRM0225C1C8R6WD05#
			8.7pF	±0.1pF	GRM0225C1C8R6BD05#
				±0.25pF	GRM0225C1C8R6CD05#
				±0.5pF	GRM0225C1C8R6DD05#
			8.8pF	±0.05pF	GRM0225C1C8R7WD05#
				±0.1pF	GRM0225C1C8R7BD05#
				±0.25pF	GRM0225C1C8R7CD05#
			8.9pF	±0.5pF	GRM0225C1C8R7DD05#
				±0.05pF	GRM0225C1C8R8WD05#
				±0.1pF	GRM0225C1C8R8BD05#
			9.0pF	±0.25pF	GRM0225C1C8R8CD05#
				±0.5pF	GRM0225C1C8R8DD05#
				±0.05pF	GRM0225C1C8R9WD05#
			9.1pF	±0.1pF	GRM0225C1C8R9BD05#
				±0.25pF	GRM0225C1C8R9CD05#
				±0.5pF	GRM0225C1C8R9DD05#
			9.2pF	±0.05pF	GRM0225C1C9R0WD05#
				±0.1pF	GRM0225C1C9R0BD05#
				±0.25pF	GRM0225C1C9R0CD05#
			9.3pF	±0.5pF	GRM0225C1C9R0DD05#
				±0.05pF	GRM0225C1C9R1WD05#
				±0.1pF	GRM0225C1C9R1BD05#
			9.4pF	±0.25pF	GRM0225C1C9R1CD05#
				±0.5pF	GRM0225C1C9R1DD05#
				±0.05pF	GRM0225C1C9R2WD05#
			9.5pF	±0.1pF	GRM0225C1C9R2BD05#
				±0.25pF	GRM0225C1C9R2CD05#
				±0.5pF	GRM0225C1C9R2DD05#
			9.6pF	±0.05pF	GRM0225C1C9R3WD05#
				±0.1pF	GRM0225C1C9R3BD05#
				±0.25pF	GRM0225C1C9R3CD05#
			9.7pF	±0.5pF	GRM0225C1C9R3DD05#
				±0.05pF	GRM0225C1C9R4WD05#
				±0.1pF	GRM0225C1C9R4BD05#
			9.8pF	±0.25pF	GRM0225C1C9R4CD05#
				±0.5pF	GRM0225C1C9R4DD05#
				±0.05pF	GRM0225C1C9R5WD05#
			9.9pF	±0.1pF	GRM0225C1C9R5BD05#
				±0.25pF	GRM0225C1C9R5CD05#
				±0.5pF	GRM0225C1C9R5DD05#
			10.0pF	±0.05pF	GRM0225C1C9R6WD05#
				±0.1pF	GRM0225C1C9R6BD05#
				±0.25pF	GRM0225C1C9R6CD05#

Part number # indicates the package specification code.

For General Purpose GRM Series  
 Capacitor Array GNM Series  
 Low ESL LL Series  
 High-Q Type GJM Series  
 High Frequency GQM Series  
 Monolithic Microchip GMA Series  
 For Bonding GMD Series  
 Product Information



## GRM Series Temperature Compensating Type Part Number List

(→ ■ 0.4x0.2mm)

T max.	Rated Voltage	TC Code	Cap.	Tol.	Part Number	T max.	Rated Voltage	TC Code	Cap.	Tol.	Part Number
0.22mm	16Vdc	C0G	9.6pF	±0.5pF	GRM0225C1C9R6DD05#	0.22mm	16Vdc	CK	1.2pF	±0.1pF	GRM0224C1C1R2BD05#
				±0.05pF	GRM0225C1C9R7WD05#					±0.25pF	GRM0224C1C1R2CD05#
			9.7pF	±0.1pF	GRM0225C1C9R7BD05#	1.3pF	±0.05pF	GRM0224C1C1R3WD05#			
				±0.25pF	GRM0225C1C9R7CD05#		±0.1pF	GRM0224C1C1R3BD05#			
				±0.5pF	GRM0225C1C9R7DD05#		±0.25pF	GRM0224C1C1R3CD05#			
				9.8pF	±0.05pF		GRM0225C1C9R8WD05#	1.4pF	±0.05pF	GRM0224C1C1R4WD05#	
			±0.1pF		GRM0225C1C9R8BD05#	±0.1pF	GRM0224C1C1R4BD05#				
			±0.25pF		GRM0225C1C9R8CD05#	±0.25pF	GRM0224C1C1R4CD05#				
			±0.5pF		GRM0225C1C9R8DD05#	1.5pF	±0.05pF		GRM0224C1C1R5WD05#		
			±0.05pF	GRM0225C1C9R9WD05#	±0.1pF		GRM0224C1C1R5BD05#				
			±0.1pF	GRM0225C1C9R9BD05#	±0.25pF		GRM0224C1C1R5CD05#				
			9.9pF	±0.25pF	GRM0225C1C9R9CD05#	1.6pF	±0.05pF	GRM0224C1C1R6WD05#			
				±0.5pF	GRM0225C1C9R9DD05#		±0.1pF	GRM0224C1C1R6BD05#			
				10pF	±2%		GRM0225C1C100GD05#	±0.25pF	GRM0224C1C1R6CD05#		
			±5%		GRM0225C1C100JD05#	1.7pF	±0.05pF	GRM0224C1C1R7WD05#			
			12pF	±2%	GRM0225C1C120GD05#		±0.1pF	GRM0224C1C1R7BD05#			
				±5%	GRM0225C1C120JD05#		±0.25pF	GRM0224C1C1R7CD05#			
			15pF	±2%	GRM0225C1C150GD05#	1.8pF	±0.05pF	GRM0224C1C1R8WD05#			
				±5%	GRM0225C1C150JD05#		±0.1pF	GRM0224C1C1R8BD05#			
			18pF	±2%	GRM0225C1C180GD05#	±0.25pF	GRM0224C1C1R8CD05#				
				±5%	GRM0225C1C180JD05#	1.9pF	±0.05pF	GRM0224C1C1R9WD05#			
			22pF	±2%	GRM0225C1C220GD05#		±0.1pF	GRM0224C1C1R9BD05#			
				±5%	GRM0225C1C220JD05#		±0.25pF	GRM0224C1C1R9CD05#			
			27pF	±2%	GRM0225C1C270GD05#	2.0pF	±0.05pF	GRM0224C1C2R0WD05#			
				±5%	GRM0225C1C270JD05#		±0.1pF	GRM0224C1C2R0BD05#			
			33pF	±2%	GRM0225C1C330GD05#	±0.25pF	GRM0224C1C2R0CD05#				
				±5%	GRM0225C1C330JD05#	CJ	2.1pF	±0.05pF	GRM0223C1C2R1WD05#		
			39pF	±2%	GRM0225C1C390GD05#			±0.1pF	GRM0223C1C2R1BD05#		
				±5%	GRM0225C1C390JD05#			±0.25pF	GRM0223C1C2R1CD05#		
			47pF	±2%	GRM0225C1C470GD05#	2.2pF	±0.05pF	GRM0223C1C2R2WD05#			
		±5%		GRM0225C1C470JD05#	±0.1pF		GRM0223C1C2R2BD05#				
		0.2pF	±0.05pF	GRM0224C1CR20WD05#	±0.25pF		GRM0223C1C2R2CD05#				
			±0.1pF	GRM0224C1CR20BD05#	2.3pF	±0.05pF	GRM0223C1C2R3WD05#				
		0.3pF	±0.05pF	GRM0224C1CR30WD05#		±0.1pF	GRM0223C1C2R3BD05#				
			±0.1pF	GRM0224C1CR30BD05#	±0.25pF	GRM0223C1C2R3CD05#					
		0.4pF	±0.05pF	GRM0224C1CR40WD05#	2.4pF	±0.05pF	GRM0223C1C2R4WD05#				
			±0.1pF	GRM0224C1CR40BD05#		±0.1pF	GRM0223C1C2R4BD05#				
		0.5pF	±0.05pF	GRM0224C1CR50WD05#	±0.25pF	GRM0223C1C2R4CD05#					
			±0.1pF	GRM0224C1CR50BD05#	2.5pF	±0.05pF	GRM0223C1C2R5WD05#				
		0.6pF	±0.05pF	GRM0224C1CR60WD05#		±0.1pF	GRM0223C1C2R5BD05#				
			±0.1pF	GRM0224C1CR60BD05#		±0.25pF	GRM0223C1C2R5CD05#				
		0.7pF	±0.05pF	GRM0224C1CR70WD05#	2.6pF	±0.05pF	GRM0223C1C2R6WD05#				
			±0.1pF	GRM0224C1CR70BD05#		±0.1pF	GRM0223C1C2R6BD05#				
		0.8pF	±0.05pF	GRM0224C1CR80WD05#	±0.25pF	GRM0223C1C2R6CD05#					
			±0.1pF	GRM0224C1CR80BD05#	2.7pF	±0.05pF	GRM0223C1C2R7WD05#				
		0.9pF	±0.05pF	GRM0224C1CR90WD05#		±0.1pF	GRM0223C1C2R7BD05#				
			±0.1pF	GRM0224C1CR90BD05#		±0.25pF	GRM0223C1C2R7CD05#				
		1.0pF	±0.05pF	GRM0224C1C1R0WD05#	2.8pF	±0.05pF	GRM0223C1C2R8WD05#				
			±0.1pF	GRM0224C1C1R0BD05#		±0.1pF	GRM0223C1C2R8BD05#				
			±0.25pF	GRM0224C1C1R0CD05#		±0.25pF	GRM0223C1C2R8CD05#				
1.1pF	±0.05pF	GRM0224C1C1R1WD05#	2.9pF	±0.05pF	GRM0223C1C2R9WD05#						
	±0.1pF	GRM0224C1C1R1BD05#		±0.1pF	GRM0223C1C2R9BD05#						
	±0.25pF	GRM0224C1C1R1CD05#		±0.25pF	GRM0223C1C2R9CD05#						
1.2pF	±0.05pF	GRM0224C1C1R2WD05#	3.0pF	±0.05pF	GRM0223C1C3R0WD05#						

Part number # indicates the package specification code.

## GRM Series Temperature Compensating Type Part Number List

(→ ■ 0.4x0.2mm)

T max.	Rated Voltage	TC Code	Cap.	Tol.	Part Number		
0.22mm	16Vdc	CJ	3.0pF	±0.1pF	GRM0223C1C3R0BD05#		
				±0.25pF	GRM0223C1C3R0CD05#		
			3.1pF	±0.05pF	GRM0223C1C3R1WD05#		
				±0.1pF	GRM0223C1C3R1BD05#		
				±0.25pF	GRM0223C1C3R1CD05#		
			3.2pF	±0.05pF	GRM0223C1C3R2WD05#		
				±0.1pF	GRM0223C1C3R2BD05#		
				±0.25pF	GRM0223C1C3R2CD05#		
			3.3pF	±0.05pF	GRM0223C1C3R3WD05#		
				±0.1pF	GRM0223C1C3R3BD05#		
				±0.25pF	GRM0223C1C3R3CD05#		
			3.4pF	±0.05pF	GRM0223C1C3R4WD05#		
				±0.1pF	GRM0223C1C3R4BD05#		
				±0.25pF	GRM0223C1C3R4CD05#		
			3.5pF	±0.05pF	GRM0223C1C3R5WD05#		
				±0.1pF	GRM0223C1C3R5BD05#		
				±0.25pF	GRM0223C1C3R5CD05#		
			3.6pF	±0.05pF	GRM0223C1C3R6WD05#		
				±0.1pF	GRM0223C1C3R6BD05#		
				±0.25pF	GRM0223C1C3R6CD05#		
			3.7pF	±0.05pF	GRM0223C1C3R7WD05#		
				±0.1pF	GRM0223C1C3R7BD05#		
				±0.25pF	GRM0223C1C3R7CD05#		
			3.8pF	±0.05pF	GRM0223C1C3R8WD05#		
				±0.1pF	GRM0223C1C3R8BD05#		
				±0.25pF	GRM0223C1C3R8CD05#		
			3.9pF	±0.05pF	GRM0223C1C3R9WD05#		
				±0.1pF	GRM0223C1C3R9BD05#		
				±0.25pF	GRM0223C1C3R9CD05#		
			CH	16Vdc	4.0pF	±0.05pF	GRM0222C1C4R0WD05#
						±0.1pF	GRM0222C1C4R0BD05#
						±0.25pF	GRM0222C1C4R0CD05#
					4.1pF	±0.05pF	GRM0222C1C4R1WD05#
						±0.1pF	GRM0222C1C4R1BD05#
						±0.25pF	GRM0222C1C4R1CD05#
					4.2pF	±0.05pF	GRM0222C1C4R2WD05#
		±0.1pF				GRM0222C1C4R2BD05#	
		±0.25pF				GRM0222C1C4R2CD05#	
		4.3pF			±0.05pF	GRM0222C1C4R3WD05#	
					±0.1pF	GRM0222C1C4R3BD05#	
					±0.25pF	GRM0222C1C4R3CD05#	
		4.4pF			±0.05pF	GRM0222C1C4R4WD05#	
					±0.1pF	GRM0222C1C4R4BD05#	
					±0.25pF	GRM0222C1C4R4CD05#	
		4.5pF			±0.05pF	GRM0222C1C4R5WD05#	
					±0.1pF	GRM0222C1C4R5BD05#	
					±0.25pF	GRM0222C1C4R5CD05#	
		4.6pF			±0.05pF	GRM0222C1C4R6WD05#	
±0.1pF	GRM0222C1C4R6BD05#						
±0.25pF	GRM0222C1C4R6CD05#						
4.7pF	±0.05pF	GRM0222C1C4R7WD05#					
	±0.1pF	GRM0222C1C4R7BD05#					
	±0.25pF	GRM0222C1C4R7CD05#					
4.8pF	±0.05pF	GRM0222C1C4R8WD05#					

T max.	Rated Voltage	TC Code	Cap.	Tol.	Part Number
0.22mm	16Vdc	CH	4.8pF	±0.1pF	GRM0222C1C4R8BD05#
				±0.25pF	GRM0222C1C4R8CD05#
			4.9pF	±0.05pF	GRM0222C1C4R9WD05#
				±0.1pF	GRM0222C1C4R9BD05#
				±0.25pF	GRM0222C1C4R9CD05#
			5.0pF	±0.05pF	GRM0222C1C5R0WD05#
				±0.1pF	GRM0222C1C5R0BD05#
				±0.25pF	GRM0222C1C5R0CD05#
			5.1pF	±0.05pF	GRM0222C1C5R1WD05#
				±0.1pF	GRM0222C1C5R1BD05#
				±0.25pF	GRM0222C1C5R1CD05#
			5.2pF	±0.05pF	GRM0222C1C5R2WD05#
				±0.1pF	GRM0222C1C5R2BD05#
				±0.25pF	GRM0222C1C5R2CD05#
			5.3pF	±0.05pF	GRM0222C1C5R3WD05#
				±0.1pF	GRM0222C1C5R3BD05#
				±0.25pF	GRM0222C1C5R3CD05#
			5.4pF	±0.05pF	GRM0222C1C5R4WD05#
				±0.1pF	GRM0222C1C5R4BD05#
				±0.25pF	GRM0222C1C5R4CD05#
			5.5pF	±0.05pF	GRM0222C1C5R5WD05#
				±0.1pF	GRM0222C1C5R5BD05#
				±0.25pF	GRM0222C1C5R5CD05#
			5.6pF	±0.05pF	GRM0222C1C5R6WD05#
				±0.1pF	GRM0222C1C5R6BD05#
				±0.25pF	GRM0222C1C5R6CD05#
			5.7pF	±0.05pF	GRM0222C1C5R7WD05#
				±0.1pF	GRM0222C1C5R7BD05#
				±0.25pF	GRM0222C1C5R7CD05#
			5.8pF	±0.05pF	GRM0222C1C5R8WD05#
				±0.1pF	GRM0222C1C5R8BD05#
				±0.25pF	GRM0222C1C5R8CD05#
			5.9pF	±0.05pF	GRM0222C1C5R9WD05#
				±0.1pF	GRM0222C1C5R9BD05#
				±0.25pF	GRM0222C1C5R9CD05#
			6.0pF	±0.05pF	GRM0222C1C6R0WD05#
				±0.1pF	GRM0222C1C6R0BD05#
				±0.25pF	GRM0222C1C6R0CD05#
			6.1pF	±0.05pF	GRM0222C1C6R1WD05#
				±0.1pF	GRM0222C1C6R1BD05#
				±0.25pF	GRM0222C1C6R1CD05#
			6.2pF	±0.05pF	GRM0222C1C6R2WD05#
				±0.1pF	GRM0222C1C6R2BD05#

Part number # indicates the package specification code.

For General Purpose GRM Series

Capacitor Array GNM Series

Low ESL LLI Series

High-Q Type GJM Series

High Frequency GQM Series

Monolithic Microchip GMA Series

For Bonding GMD Series

Product Information

## GRM Series Temperature Compensating Type Part Number List

(→ ■ 0.4x0.2mm)

T max.	Rated Voltage	TC Code	Cap.	Tol.	Part Number
0.22mm	16Vdc	CH	6.2pF	±0.25pF	GRM0222C1C6R2CD05#
				±0.5pF	GRM0222C1C6R2DD05#
			6.3pF	±0.05pF	GRM0222C1C6R3WD05#
				±0.1pF	GRM0222C1C6R3BD05#
				±0.25pF	GRM0222C1C6R3CD05#
				±0.5pF	GRM0222C1C6R3DD05#
			6.4pF	±0.05pF	GRM0222C1C6R4WD05#
				±0.1pF	GRM0222C1C6R4BD05#
				±0.25pF	GRM0222C1C6R4CD05#
				±0.5pF	GRM0222C1C6R4DD05#
			6.5pF	±0.05pF	GRM0222C1C6R5WD05#
				±0.1pF	GRM0222C1C6R5BD05#
				±0.25pF	GRM0222C1C6R5CD05#
				±0.5pF	GRM0222C1C6R5DD05#
			6.6pF	±0.05pF	GRM0222C1C6R6WD05#
				±0.1pF	GRM0222C1C6R6BD05#
				±0.25pF	GRM0222C1C6R6CD05#
				±0.5pF	GRM0222C1C6R6DD05#
			6.7pF	±0.05pF	GRM0222C1C6R7WD05#
				±0.1pF	GRM0222C1C6R7BD05#
				±0.25pF	GRM0222C1C6R7CD05#
				±0.5pF	GRM0222C1C6R7DD05#
			6.8pF	±0.05pF	GRM0222C1C6R8WD05#
				±0.1pF	GRM0222C1C6R8BD05#
				±0.25pF	GRM0222C1C6R8CD05#
				±0.5pF	GRM0222C1C6R8DD05#
			6.9pF	±0.05pF	GRM0222C1C6R9WD05#
				±0.1pF	GRM0222C1C6R9BD05#
				±0.25pF	GRM0222C1C6R9CD05#
				±0.5pF	GRM0222C1C6R9DD05#
			7.0pF	±0.05pF	GRM0222C1C7R0WD05#
				±0.1pF	GRM0222C1C7R0BD05#
				±0.25pF	GRM0222C1C7R0CD05#
				±0.5pF	GRM0222C1C7R0DD05#
			7.1pF	±0.05pF	GRM0222C1C7R1WD05#
				±0.1pF	GRM0222C1C7R1BD05#
				±0.25pF	GRM0222C1C7R1CD05#
				±0.5pF	GRM0222C1C7R1DD05#
			7.2pF	±0.05pF	GRM0222C1C7R2WD05#
				±0.1pF	GRM0222C1C7R2BD05#
				±0.25pF	GRM0222C1C7R2CD05#
				±0.5pF	GRM0222C1C7R2DD05#
			7.3pF	±0.05pF	GRM0222C1C7R3WD05#
				±0.1pF	GRM0222C1C7R3BD05#
				±0.25pF	GRM0222C1C7R3CD05#
				±0.5pF	GRM0222C1C7R3DD05#
			7.4pF	±0.05pF	GRM0222C1C7R4WD05#
				±0.1pF	GRM0222C1C7R4BD05#
				±0.25pF	GRM0222C1C7R4CD05#
				±0.5pF	GRM0222C1C7R4DD05#
			7.5pF	±0.05pF	GRM0222C1C7R5WD05#
				±0.1pF	GRM0222C1C7R5BD05#
				±0.25pF	GRM0222C1C7R5CD05#
				±0.5pF	GRM0222C1C7R5DD05#

T max.	Rated Voltage	TC Code	Cap.	Tol.	Part Number
0.22mm	16Vdc	CH	7.6pF	±0.05pF	GRM0222C1C7R6WD05#
				±0.1pF	GRM0222C1C7R6BD05#
				±0.25pF	GRM0222C1C7R6CD05#
				±0.5pF	GRM0222C1C7R6DD05#
			7.7pF	±0.05pF	GRM0222C1C7R7WD05#
				±0.1pF	GRM0222C1C7R7BD05#
				±0.25pF	GRM0222C1C7R7CD05#
			7.8pF	±0.05pF	GRM0222C1C7R8WD05#
				±0.1pF	GRM0222C1C7R8BD05#
				±0.25pF	GRM0222C1C7R8CD05#
			7.9pF	±0.05pF	GRM0222C1C7R9WD05#
				±0.1pF	GRM0222C1C7R9BD05#
				±0.25pF	GRM0222C1C7R9CD05#
			8.0pF	±0.05pF	GRM0222C1C8R0WD05#
				±0.1pF	GRM0222C1C8R0BD05#
				±0.25pF	GRM0222C1C8R0CD05#
			8.1pF	±0.05pF	GRM0222C1C8R1WD05#
				±0.1pF	GRM0222C1C8R1BD05#
				±0.25pF	GRM0222C1C8R1CD05#
			8.2pF	±0.05pF	GRM0222C1C8R2WD05#
				±0.1pF	GRM0222C1C8R2BD05#
				±0.25pF	GRM0222C1C8R2CD05#
			8.3pF	±0.05pF	GRM0222C1C8R3WD05#
				±0.1pF	GRM0222C1C8R3BD05#
				±0.25pF	GRM0222C1C8R3CD05#
			8.4pF	±0.05pF	GRM0222C1C8R4WD05#
				±0.1pF	GRM0222C1C8R4BD05#
				±0.25pF	GRM0222C1C8R4CD05#
			8.5pF	±0.05pF	GRM0222C1C8R5WD05#
				±0.1pF	GRM0222C1C8R5BD05#
				±0.25pF	GRM0222C1C8R5CD05#
			8.6pF	±0.05pF	GRM0222C1C8R6WD05#
				±0.1pF	GRM0222C1C8R6BD05#
				±0.25pF	GRM0222C1C8R6CD05#
			8.7pF	±0.05pF	GRM0222C1C8R7WD05#
				±0.1pF	GRM0222C1C8R7BD05#
				±0.25pF	GRM0222C1C8R7CD05#
			8.8pF	±0.05pF	GRM0222C1C8R8WD05#
				±0.1pF	GRM0222C1C8R8BD05#
				±0.25pF	GRM0222C1C8R8CD05#
			8.9pF	±0.05pF	GRM0222C1C8R9WD05#
				±0.1pF	GRM0222C1C8R9BD05#

Part number # indicates the package specification code.



## GRM Series Temperature Compensating Type Part Number List

(→ ■ 0.4x0.2mm)

T max.	Rated Voltage	TC Code	Cap.	Tol.	Part Number
0.22mm	16Vdc	CH	8.9pF	±0.25pF	GRM0222C1C8R9CD05#
				±0.5pF	GRM0222C1C8R9DD05#
			9.0pF	±0.05pF	GRM0222C1C9R0WD05#
				±0.1pF	GRM0222C1C9R0BD05#
				±0.25pF	GRM0222C1C9R0CD05#
				±0.5pF	GRM0222C1C9R0DD05#
			9.1pF	±0.05pF	GRM0222C1C9R1WD05#
				±0.1pF	GRM0222C1C9R1BD05#
				±0.25pF	GRM0222C1C9R1CD05#
				±0.5pF	GRM0222C1C9R1DD05#
			9.2pF	±0.05pF	GRM0222C1C9R2WD05#
				±0.1pF	GRM0222C1C9R2BD05#
				±0.25pF	GRM0222C1C9R2CD05#
				±0.5pF	GRM0222C1C9R2DD05#
			9.3pF	±0.05pF	GRM0222C1C9R3WD05#
				±0.1pF	GRM0222C1C9R3BD05#
				±0.25pF	GRM0222C1C9R3CD05#
				±0.5pF	GRM0222C1C9R3DD05#
			9.4pF	±0.05pF	GRM0222C1C9R4WD05#
				±0.1pF	GRM0222C1C9R4BD05#
				±0.25pF	GRM0222C1C9R4CD05#
				±0.5pF	GRM0222C1C9R4DD05#
			9.5pF	±0.05pF	GRM0222C1C9R5WD05#
				±0.1pF	GRM0222C1C9R5BD05#
				±0.25pF	GRM0222C1C9R5CD05#
				±0.5pF	GRM0222C1C9R5DD05#
			9.6pF	±0.05pF	GRM0222C1C9R6WD05#
				±0.1pF	GRM0222C1C9R6BD05#
				±0.25pF	GRM0222C1C9R6CD05#
				±0.5pF	GRM0222C1C9R6DD05#
			9.7pF	±0.05pF	GRM0222C1C9R7WD05#
				±0.1pF	GRM0222C1C9R7BD05#
				±0.25pF	GRM0222C1C9R7CD05#
				±0.5pF	GRM0222C1C9R7DD05#
			9.8pF	±0.05pF	GRM0222C1C9R8WD05#
				±0.1pF	GRM0222C1C9R8BD05#
				±0.25pF	GRM0222C1C9R8CD05#
				±0.5pF	GRM0222C1C9R8DD05#
			9.9pF	±0.05pF	GRM0222C1C9R9WD05#
				±0.1pF	GRM0222C1C9R9BD05#
				±0.25pF	GRM0222C1C9R9CD05#
				±0.5pF	GRM0222C1C9R9DD05#
			10pF	±2%	GRM0222C1C100GD05#
				±5%	GRM0222C1C100JD05#
			12pF	±2%	GRM0222C1C120GD05#
				±5%	GRM0222C1C120JD05#
			15pF	±2%	GRM0222C1C150GD05#
				±5%	GRM0222C1C150JD05#
			18pF	±2%	GRM0222C1C180GD05#
				±5%	GRM0222C1C180JD05#
			22pF	±2%	GRM0222C1C220GD05#
				±5%	GRM0222C1C220JD05#
			27pF	±2%	GRM0222C1C270GD05#
				±5%	GRM0222C1C270JD05#

T max.	Rated Voltage	TC Code	Cap.	Tol.	Part Number		
0.22mm	16Vdc	CH	33pF	±2%	GRM0222C1C330GD05#		
				±5%	GRM0222C1C330JD05#		
			39pF	±2%	GRM0222C1C390GD05#		
				±5%	GRM0222C1C390JD05#		
			47pF	±2%	GRM0222C1C470GD05#		
				±5%	GRM0222C1C470JD05#		
			10Vdc	C0G	56pF	±2%	GRM0225C1A560GD05#
						±5%	GRM0225C1A560JD05#
					68pF	±2%	GRM0225C1A680GD05#
	±5%	GRM0225C1A680JD05#					
	82pF	±2%			GRM0225C1A820GD05#		
		±5%			GRM0225C1A820JD05#		
	100pF	±2%			GRM0225C1A101GD05#		
		±5%			GRM0225C1A101JD05#		
	CH	56pF			±2%	GRM0222C1A560GD05#	
			±5%	GRM0222C1A560JD05#			
		68pF	±2%	GRM0222C1A680GD05#			
			±5%	GRM0222C1A680JD05#			
82pF		±2%	GRM0222C1A820GD05#				
		±5%	GRM0222C1A820JD05#				
100pF		±2%	GRM0222C1A101GD05#				
		±5%	GRM0222C1A101JD05#				

■ 0.6x0.3mm Ultra-compact

T max.	Rated Voltage	TC Code	Cap.	Tol.	Part Number
0.33mm	50Vdc	C0G	0.1pF	±0.05pF	GRM0335C1HR10WA01#
				±0.1pF	GRM0335C1HR10BA01#
			0.2pF	±0.05pF	GRM0335C1HR20WA01#
				±0.1pF	GRM0335C1HR20BA01#
			0.3pF	±0.05pF	GRM0335C1HR30WA01#
				±0.1pF	GRM0335C1HR30BA01#
			0.4pF	±0.05pF	GRM0335C1HR40WA01#
				±0.1pF	GRM0335C1HR40BA01#
			0.5pF	±0.05pF	GRM0335C1HR50WA01#
				±0.1pF	GRM0335C1HR50BA01#
			0.6pF	±0.05pF	GRM0335C1HR60WA01#
				±0.1pF	GRM0335C1HR60BA01#
			0.7pF	±0.05pF	GRM0335C1HR70WA01#
				±0.1pF	GRM0335C1HR70BA01#
			0.8pF	±0.05pF	GRM0335C1HR80WA01#
				±0.1pF	GRM0335C1HR80BA01#
			0.9pF	±0.05pF	GRM0335C1HR90WA01#
				±0.1pF	GRM0335C1HR90BA01#
			1.0pF	±0.05pF	GRM0335C1H1R0WA01#
				±0.1pF	GRM0335C1H1R0BA01#
				±0.25pF	GRM0335C1H1R0CA01#
			1.1pF	±0.05pF	GRM0335C1H1R1WA01#
				±0.1pF	GRM0335C1H1R1BA01#
				±0.25pF	GRM0335C1H1R1CA01#
1.2pF	±0.05pF	GRM0335C1H1R2WA01#			
	±0.1pF	GRM0335C1H1R2BA01#			
	±0.25pF	GRM0335C1H1R2CA01#			

Part number # indicates the package specification code.

For General Purpose GRM Series  
 Capacitor Array GNM Series  
 Low ESL LLI Series  
 High-Q Type GJM Series  
 High Frequency GQM Series  
 Monolithic Microchip GMA Series  
 For Bonding GMD Series  
 Product Information

## GRM Series Temperature Compensating Type Part Number List

(→ ■ 0.6x0.3mm)

T max.	Rated Voltage	TC Code	Cap.	Tol.	Part Number
0.33mm	50Vdc	C0G	1.3pF	±0.05pF	GRM0335C1H1R3WA01#
				±0.1pF	GRM0335C1H1R3BA01#
				±0.25pF	GRM0335C1H1R3CA01#
			1.4pF	±0.05pF	GRM0335C1H1R4WA01#
				±0.1pF	GRM0335C1H1R4BA01#
				±0.25pF	GRM0335C1H1R4CA01#
			1.5pF	±0.05pF	GRM0335C1H1R5WA01#
				±0.1pF	GRM0335C1H1R5BA01#
				±0.25pF	GRM0335C1H1R5CA01#
			1.6pF	±0.05pF	GRM0335C1H1R6WA01#
				±0.1pF	GRM0335C1H1R6BA01#
				±0.25pF	GRM0335C1H1R6CA01#
			1.7pF	±0.05pF	GRM0335C1H1R7WA01#
				±0.1pF	GRM0335C1H1R7BA01#
				±0.25pF	GRM0335C1H1R7CA01#
			1.8pF	±0.05pF	GRM0335C1H1R8WA01#
				±0.1pF	GRM0335C1H1R8BA01#
				±0.25pF	GRM0335C1H1R8CA01#
			1.9pF	±0.05pF	GRM0335C1H1R9WA01#
				±0.1pF	GRM0335C1H1R9BA01#
				±0.25pF	GRM0335C1H1R9CA01#
			2.0pF	±0.05pF	GRM0335C1H2R0WA01#
				±0.1pF	GRM0335C1H2R0BA01#
				±0.25pF	GRM0335C1H2R0CA01#
			2.1pF	±0.05pF	GRM0335C1H2R1WA01#
				±0.1pF	GRM0335C1H2R1BA01#
				±0.25pF	GRM0335C1H2R1CA01#
			2.2pF	±0.05pF	GRM0335C1H2R2WA01#
				±0.1pF	GRM0335C1H2R2BA01#
				±0.25pF	GRM0335C1H2R2CA01#
			2.3pF	±0.05pF	GRM0335C1H2R3WA01#
				±0.1pF	GRM0335C1H2R3BA01#
				±0.25pF	GRM0335C1H2R3CA01#
			2.4pF	±0.05pF	GRM0335C1H2R4WA01#
				±0.1pF	GRM0335C1H2R4BA01#
				±0.25pF	GRM0335C1H2R4CA01#
			2.5pF	±0.05pF	GRM0335C1H2R5WA01#
				±0.1pF	GRM0335C1H2R5BA01#
				±0.25pF	GRM0335C1H2R5CA01#
			2.6pF	±0.05pF	GRM0335C1H2R6WA01#
				±0.1pF	GRM0335C1H2R6BA01#
				±0.25pF	GRM0335C1H2R6CA01#
			2.7pF	±0.05pF	GRM0335C1H2R7WA01#
				±0.1pF	GRM0335C1H2R7BA01#
				±0.25pF	GRM0335C1H2R7CA01#
2.8pF	±0.05pF	GRM0335C1H2R8WA01#			
	±0.1pF	GRM0335C1H2R8BA01#			
	±0.25pF	GRM0335C1H2R8CA01#			
2.9pF	±0.05pF	GRM0335C1H2R9WA01#			
	±0.1pF	GRM0335C1H2R9BA01#			
	±0.25pF	GRM0335C1H2R9CA01#			
3.0pF	±0.05pF	GRM0335C1H3R0WA01#			
	±0.1pF	GRM0335C1H3R0BA01#			
	±0.25pF	GRM0335C1H3R0CA01#			

T max.	Rated Voltage	TC Code	Cap.	Tol.	Part Number
0.33mm	50Vdc	C0G	3.1pF	±0.05pF	GRM0335C1H3R1WA01#
				±0.1pF	GRM0335C1H3R1BA01#
				±0.25pF	GRM0335C1H3R1CA01#
			3.2pF	±0.05pF	GRM0335C1H3R2WA01#
				±0.1pF	GRM0335C1H3R2BA01#
				±0.25pF	GRM0335C1H3R2CA01#
			3.3pF	±0.05pF	GRM0335C1H3R3WA01#
				±0.1pF	GRM0335C1H3R3BA01#
				±0.25pF	GRM0335C1H3R3CA01#
			3.4pF	±0.05pF	GRM0335C1H3R4WA01#
				±0.1pF	GRM0335C1H3R4BA01#
				±0.25pF	GRM0335C1H3R4CA01#
			3.5pF	±0.05pF	GRM0335C1H3R5WA01#
				±0.1pF	GRM0335C1H3R5BA01#
				±0.25pF	GRM0335C1H3R5CA01#
			3.6pF	±0.05pF	GRM0335C1H3R6WA01#
				±0.1pF	GRM0335C1H3R6BA01#
				±0.25pF	GRM0335C1H3R6CA01#
			3.7pF	±0.05pF	GRM0335C1H3R7WA01#
				±0.1pF	GRM0335C1H3R7BA01#
				±0.25pF	GRM0335C1H3R7CA01#
			3.8pF	±0.05pF	GRM0335C1H3R8WA01#
				±0.1pF	GRM0335C1H3R8BA01#
				±0.25pF	GRM0335C1H3R8CA01#
			3.9pF	±0.05pF	GRM0335C1H3R9WA01#
				±0.1pF	GRM0335C1H3R9BA01#
				±0.25pF	GRM0335C1H3R9CA01#
			4.0pF	±0.05pF	GRM0335C1H4R0WA01#
				±0.1pF	GRM0335C1H4R0BA01#
				±0.25pF	GRM0335C1H4R0CA01#
			4.1pF	±0.05pF	GRM0335C1H4R1WA01#
				±0.1pF	GRM0335C1H4R1BA01#
				±0.25pF	GRM0335C1H4R1CA01#
			4.2pF	±0.05pF	GRM0335C1H4R2WA01#
				±0.1pF	GRM0335C1H4R2BA01#
				±0.25pF	GRM0335C1H4R2CA01#
			4.3pF	±0.05pF	GRM0335C1H4R3WA01#
				±0.1pF	GRM0335C1H4R3BA01#
				±0.25pF	GRM0335C1H4R3CA01#
			4.4pF	±0.05pF	GRM0335C1H4R4WA01#
				±0.1pF	GRM0335C1H4R4BA01#
				±0.25pF	GRM0335C1H4R4CA01#
			4.5pF	±0.05pF	GRM0335C1H4R5WA01#
				±0.1pF	GRM0335C1H4R5BA01#
				±0.25pF	GRM0335C1H4R5CA01#
4.6pF	±0.05pF	GRM0335C1H4R6WA01#			
	±0.1pF	GRM0335C1H4R6BA01#			
	±0.25pF	GRM0335C1H4R6CA01#			
4.7pF	±0.05pF	GRM0335C1H4R7WA01#			
	±0.1pF	GRM0335C1H4R7BA01#			
	±0.25pF	GRM0335C1H4R7CA01#			
4.8pF	±0.05pF	GRM0335C1H4R8WA01#			
	±0.1pF	GRM0335C1H4R8BA01#			
	±0.25pF	GRM0335C1H4R8CA01#			

Part number # indicates the package specification code.

## GRM Series Temperature Compensating Type Part Number List

(→ ■ 0.6x0.3mm)

T max.	Rated Voltage	TC Code	Cap.	Tol.	Part Number
0.33mm	50Vdc	C0G	4.9pF	±0.05pF	GRM0335C1H4R9WA01#
				±0.1pF	GRM0335C1H4R9BA01#
				±0.25pF	GRM0335C1H4R9CA01#
			5.0pF	±0.05pF	GRM0335C1H5R0WA01#
				±0.1pF	GRM0335C1H5R0BA01#
				±0.25pF	GRM0335C1H5R0CA01#
			5.1pF	±0.05pF	GRM0335C1H5R1WA01#
				±0.1pF	GRM0335C1H5R1BA01#
				±0.25pF	GRM0335C1H5R1CA01#
				±0.5pF	GRM0335C1H5R1DA01#
			5.2pF	±0.05pF	GRM0335C1H5R2WA01#
				±0.1pF	GRM0335C1H5R2BA01#
				±0.25pF	GRM0335C1H5R2CA01#
				±0.5pF	GRM0335C1H5R2DA01#
			5.3pF	±0.05pF	GRM0335C1H5R3WA01#
				±0.1pF	GRM0335C1H5R3BA01#
				±0.25pF	GRM0335C1H5R3CA01#
				±0.5pF	GRM0335C1H5R3DA01#
			5.4pF	±0.05pF	GRM0335C1H5R4WA01#
				±0.1pF	GRM0335C1H5R4BA01#
				±0.25pF	GRM0335C1H5R4CA01#
				±0.5pF	GRM0335C1H5R4DA01#
			5.5pF	±0.05pF	GRM0335C1H5R5WA01#
				±0.1pF	GRM0335C1H5R5BA01#
				±0.25pF	GRM0335C1H5R5CA01#
				±0.5pF	GRM0335C1H5R5DA01#
			5.6pF	±0.05pF	GRM0335C1H5R6WA01#
				±0.1pF	GRM0335C1H5R6BA01#
				±0.25pF	GRM0335C1H5R6CA01#
				±0.5pF	GRM0335C1H5R6DA01#
			5.7pF	±0.05pF	GRM0335C1H5R7WA01#
				±0.1pF	GRM0335C1H5R7BA01#
				±0.25pF	GRM0335C1H5R7CA01#
				±0.5pF	GRM0335C1H5R7DA01#
			5.8pF	±0.05pF	GRM0335C1H5R8WA01#
				±0.1pF	GRM0335C1H5R8BA01#
				±0.25pF	GRM0335C1H5R8CA01#
				±0.5pF	GRM0335C1H5R8DA01#
			5.9pF	±0.05pF	GRM0335C1H5R9WA01#
				±0.1pF	GRM0335C1H5R9BA01#
				±0.25pF	GRM0335C1H5R9CA01#
				±0.5pF	GRM0335C1H5R9DA01#
			6.0pF	±0.05pF	GRM0335C1H6R0WA01#
				±0.1pF	GRM0335C1H6R0BA01#
				±0.25pF	GRM0335C1H6R0CA01#
				±0.5pF	GRM0335C1H6R0DA01#
			6.1pF	±0.05pF	GRM0335C1H6R1WA01#
				±0.1pF	GRM0335C1H6R1BA01#
				±0.25pF	GRM0335C1H6R1CA01#
				±0.5pF	GRM0335C1H6R1DA01#
			6.2pF	±0.05pF	GRM0335C1H6R2WA01#
				±0.1pF	GRM0335C1H6R2BA01#
				±0.25pF	GRM0335C1H6R2CA01#
				±0.5pF	GRM0335C1H6R2DA01#

T max.	Rated Voltage	TC Code	Cap.	Tol.	Part Number
0.33mm	50Vdc	C0G	6.3pF	±0.05pF	GRM0335C1H6R3WA01#
				±0.1pF	GRM0335C1H6R3BA01#
				±0.25pF	GRM0335C1H6R3CA01#
				±0.5pF	GRM0335C1H6R3DA01#
			6.4pF	±0.05pF	GRM0335C1H6R4WA01#
				±0.1pF	GRM0335C1H6R4BA01#
				±0.25pF	GRM0335C1H6R4CA01#
			6.5pF	±0.05pF	GRM0335C1H6R5WA01#
				±0.1pF	GRM0335C1H6R5BA01#
				±0.25pF	GRM0335C1H6R5CA01#
			6.6pF	±0.05pF	GRM0335C1H6R6WA01#
				±0.1pF	GRM0335C1H6R6BA01#
				±0.25pF	GRM0335C1H6R6CA01#
			6.7pF	±0.05pF	GRM0335C1H6R7WA01#
				±0.1pF	GRM0335C1H6R7BA01#
				±0.25pF	GRM0335C1H6R7CA01#
			6.8pF	±0.05pF	GRM0335C1H6R8WA01#
				±0.1pF	GRM0335C1H6R8BA01#
				±0.25pF	GRM0335C1H6R8CA01#
			6.9pF	±0.05pF	GRM0335C1H6R9WA01#
				±0.1pF	GRM0335C1H6R9BA01#
				±0.25pF	GRM0335C1H6R9CA01#
			7.0pF	±0.05pF	GRM0335C1H7R0WA01#
				±0.1pF	GRM0335C1H7R0BA01#
				±0.25pF	GRM0335C1H7R0CA01#
			7.1pF	±0.05pF	GRM0335C1H7R1WA01#
				±0.1pF	GRM0335C1H7R1BA01#
				±0.25pF	GRM0335C1H7R1CA01#
			7.2pF	±0.05pF	GRM0335C1H7R2WA01#
				±0.1pF	GRM0335C1H7R2BA01#
				±0.25pF	GRM0335C1H7R2CA01#
			7.3pF	±0.05pF	GRM0335C1H7R3WA01#
				±0.1pF	GRM0335C1H7R3BA01#
				±0.25pF	GRM0335C1H7R3CA01#
			7.4pF	±0.05pF	GRM0335C1H7R4WA01#
				±0.1pF	GRM0335C1H7R4BA01#
				±0.25pF	GRM0335C1H7R4CA01#
			7.5pF	±0.05pF	GRM0335C1H7R5WA01#
				±0.1pF	GRM0335C1H7R5BA01#
				±0.25pF	GRM0335C1H7R5CA01#
			7.6pF	±0.05pF	GRM0335C1H7R6WA01#
				±0.1pF	GRM0335C1H7R6BA01#

Part number # indicates the package specification code.

For General Purpose GRM Series  
 Capacitor Array GNM Series  
 Low ESL LLI Series  
 High-Q Type GJM Series  
 High Frequency GQM Series  
 Monolithic Microchip GMA Series  
 For Bonding GMD Series  
 Product Information

## GRM Series Temperature Compensating Type Part Number List

(→ ■ 0.6x0.3mm)

T max.	Rated Voltage	TC Code	Cap.	Tol.	Part Number
0.33mm	50Vdc	C0G	7.6pF	±0.25pF	GRM0335C1H7R6CA01#
				±0.5pF	GRM0335C1H7R6DA01#
			7.7pF	±0.05pF	GRM0335C1H7R7WA01#
				±0.1pF	GRM0335C1H7R7BA01#
				±0.25pF	GRM0335C1H7R7CA01#
			7.8pF	±0.05pF	GRM0335C1H7R8WA01#
				±0.1pF	GRM0335C1H7R8BA01#
				±0.25pF	GRM0335C1H7R8CA01#
				±0.5pF	GRM0335C1H7R8DA01#
			7.9pF	±0.05pF	GRM0335C1H7R9WA01#
				±0.1pF	GRM0335C1H7R9BA01#
				±0.25pF	GRM0335C1H7R9CA01#
			8.0pF	±0.05pF	GRM0335C1H8R0WA01#
				±0.1pF	GRM0335C1H8R0BA01#
				±0.25pF	GRM0335C1H8R0CA01#
			8.1pF	±0.05pF	GRM0335C1H8R1WA01#
				±0.1pF	GRM0335C1H8R1BA01#
				±0.25pF	GRM0335C1H8R1CA01#
				±0.5pF	GRM0335C1H8R1DA01#
			8.2pF	±0.05pF	GRM0335C1H8R2WA01#
				±0.1pF	GRM0335C1H8R2BA01#
				±0.25pF	GRM0335C1H8R2CA01#
				±0.5pF	GRM0335C1H8R2DA01#
			8.3pF	±0.05pF	GRM0335C1H8R3WA01#
				±0.1pF	GRM0335C1H8R3BA01#
				±0.25pF	GRM0335C1H8R3CA01#
				±0.5pF	GRM0335C1H8R3DA01#
			8.4pF	±0.05pF	GRM0335C1H8R4WA01#
				±0.1pF	GRM0335C1H8R4BA01#
				±0.25pF	GRM0335C1H8R4CA01#
				±0.5pF	GRM0335C1H8R4DA01#
			8.5pF	±0.05pF	GRM0335C1H8R5WA01#
				±0.1pF	GRM0335C1H8R5BA01#
				±0.25pF	GRM0335C1H8R5CA01#
				±0.5pF	GRM0335C1H8R5DA01#
			8.6pF	±0.05pF	GRM0335C1H8R6WA01#
				±0.1pF	GRM0335C1H8R6BA01#
				±0.25pF	GRM0335C1H8R6CA01#
				±0.5pF	GRM0335C1H8R6DA01#
			8.7pF	±0.05pF	GRM0335C1H8R7WA01#
				±0.1pF	GRM0335C1H8R7BA01#
				±0.25pF	GRM0335C1H8R7CA01#
				±0.5pF	GRM0335C1H8R7DA01#
			8.8pF	±0.05pF	GRM0335C1H8R8WA01#
				±0.1pF	GRM0335C1H8R8BA01#
				±0.25pF	GRM0335C1H8R8CA01#
				±0.5pF	GRM0335C1H8R8DA01#
			8.9pF	±0.05pF	GRM0335C1H8R9WA01#
				±0.1pF	GRM0335C1H8R9BA01#
				±0.25pF	GRM0335C1H8R9CA01#
				±0.5pF	GRM0335C1H8R9DA01#

T max.	Rated Voltage	TC Code	Cap.	Tol.	Part Number
0.33mm	50Vdc	C0G	9.0pF	±0.05pF	GRM0335C1H9R0WA01#
				±0.1pF	GRM0335C1H9R0BA01#
				±0.25pF	GRM0335C1H9R0CA01#
				±0.5pF	GRM0335C1H9R0DA01#
			9.1pF	±0.05pF	GRM0335C1H9R1WA01#
				±0.1pF	GRM0335C1H9R1BA01#
				±0.25pF	GRM0335C1H9R1CA01#
			9.2pF	±0.05pF	GRM0335C1H9R2WA01#
				±0.1pF	GRM0335C1H9R2BA01#
				±0.25pF	GRM0335C1H9R2CA01#
			9.3pF	±0.05pF	GRM0335C1H9R3WA01#
				±0.1pF	GRM0335C1H9R3BA01#
				±0.25pF	GRM0335C1H9R3CA01#
			9.4pF	±0.05pF	GRM0335C1H9R4WA01#
				±0.1pF	GRM0335C1H9R4BA01#
				±0.25pF	GRM0335C1H9R4CA01#
			9.5pF	±0.05pF	GRM0335C1H9R5WA01#
				±0.1pF	GRM0335C1H9R5BA01#
				±0.25pF	GRM0335C1H9R5CA01#
			9.6pF	±0.05pF	GRM0335C1H9R6WA01#
				±0.1pF	GRM0335C1H9R6BA01#
				±0.25pF	GRM0335C1H9R6CA01#
			9.7pF	±0.05pF	GRM0335C1H9R7WA01#
				±0.1pF	GRM0335C1H9R7BA01#
				±0.25pF	GRM0335C1H9R7CA01#
			9.8pF	±0.05pF	GRM0335C1H9R8WA01#
				±0.1pF	GRM0335C1H9R8BA01#
				±0.25pF	GRM0335C1H9R8CA01#
			9.9pF	±0.05pF	GRM0335C1H9R9WA01#
				±0.1pF	GRM0335C1H9R9BA01#
				±0.25pF	GRM0335C1H9R9CA01#
			10pF	±2%	GRM0335C1H100GA01#
				±5%	GRM0335C1H100JA01#
			12pF	±2%	GRM0335C1H120GA01#
				±5%	GRM0335C1H120JA01#
			15pF	±2%	GRM0335C1H150GA01#
				±5%	GRM0335C1H150JA01#
			18pF	±2%	GRM0335C1H180GA01#
				±5%	GRM0335C1H180JA01#
			22pF	±2%	GRM0335C1H220GA01#
				±5%	GRM0335C1H220JA01#
			27pF	±2%	GRM0335C1H270GA01#
±5%	GRM0335C1H270JA01#				
33pF	±2%	GRM0335C1H330GA01#			
	±5%	GRM0335C1H330JA01#			

Part number # indicates the package specification code.



## GRM Series Temperature Compensating Type Part Number List

(→ ■ 0.6x0.3mm)

T max.	Rated Voltage	TC Code	Cap.	Tol.	Part Number	
0.33mm	50Vdc	C0G	39pF	±2%	GRM0335C1H390GA01#	
				±5%	GRM0335C1H390JA01#	
			47pF	±2%	GRM0335C1H470GA01#	
				±5%	GRM0335C1H470JA01#	
			56pF	±2%	GRM0335C1H560GA01#	
				±5%	GRM0335C1H560JA01#	
			68pF	±2%	GRM0335C1H680GA01#	
				±5%	GRM0335C1H680JA01#	
			82pF	±2%	GRM0335C1H820GA01#	
				±5%	GRM0335C1H820JA01#	
			100pF	±2%	GRM0335C1H101GA01#	
				±5%	GRM0335C1H101JA01#	
					GRM0335C1H101JA01#	
			CK	0.1pF	±0.05pF	GRM0334C1HR10WA01#
					±0.1pF	GRM0334C1HR10BA01#
				0.2pF	±0.05pF	GRM0334C1HR20WA01#
					±0.1pF	GRM0334C1HR20BA01#
				0.3pF	±0.05pF	GRM0334C1HR30WA01#
					±0.1pF	GRM0334C1HR30BA01#
				0.4pF	±0.05pF	GRM0334C1HR40WA01#
					±0.1pF	GRM0334C1HR40BA01#
				0.5pF	±0.05pF	GRM0334C1HR50WA01#
					±0.1pF	GRM0334C1HR50BA01#
				0.6pF	±0.05pF	GRM0334C1HR60WA01#
		±0.1pF			GRM0334C1HR60BA01#	
		0.7pF		±0.05pF	GRM0334C1HR70WA01#	
				±0.1pF	GRM0334C1HR70BA01#	
		0.8pF		±0.05pF	GRM0334C1HR80WA01#	
				±0.1pF	GRM0334C1HR80BA01#	
		0.9pF		±0.05pF	GRM0334C1HR90WA01#	
				±0.1pF	GRM0334C1HR90BA01#	
		1.0pF		±0.05pF	GRM0334C1H1R0WA01#	
				±0.1pF	GRM0334C1H1R0BA01#	
				±0.25pF	GRM0334C1H1R0CA01#	
		1.1pF		±0.05pF	GRM0334C1H1R1WA01#	
				±0.1pF	GRM0334C1H1R1BA01#	
				±0.25pF	GRM0334C1H1R1CA01#	
		1.2pF	±0.05pF	GRM0334C1H1R2WA01#		
			±0.1pF	GRM0334C1H1R2BA01#		
			±0.25pF	GRM0334C1H1R2CA01#		
		1.3pF	±0.05pF	GRM0334C1H1R3WA01#		
			±0.1pF	GRM0334C1H1R3BA01#		
			±0.25pF	GRM0334C1H1R3CA01#		
		1.4pF	±0.05pF	GRM0334C1H1R4WA01#		
			±0.1pF	GRM0334C1H1R4BA01#		
			±0.25pF	GRM0334C1H1R4CA01#		
		1.5pF	±0.05pF	GRM0334C1H1R5WA01#		
			±0.1pF	GRM0334C1H1R5BA01#		
±0.25pF	GRM0334C1H1R5CA01#					
1.6pF	±0.05pF	GRM0334C1H1R6WA01#				
	±0.1pF	GRM0334C1H1R6BA01#				
	±0.25pF	GRM0334C1H1R6CA01#				
1.7pF	±0.05pF	GRM0334C1H1R7WA01#				
	±0.1pF	GRM0334C1H1R7BA01#				
	±0.25pF	GRM0334C1H1R7CA01#				

T max.	Rated Voltage	TC Code	Cap.	Tol.	Part Number	
0.33mm	50Vdc	CK	1.8pF	±0.05pF	GRM0334C1H1R8WA01#	
				±0.1pF	GRM0334C1H1R8BA01#	
				±0.25pF	GRM0334C1H1R8CA01#	
			1.9pF	±0.05pF	GRM0334C1H1R9WA01#	
				±0.1pF	GRM0334C1H1R9BA01#	
				±0.25pF	GRM0334C1H1R9CA01#	
			2.0pF	±0.05pF	GRM0334C1H2R0WA01#	
				±0.1pF	GRM0334C1H2R0BA01#	
				±0.25pF	GRM0334C1H2R0CA01#	
			CJ	2.1pF	±0.05pF	GRM0333C1H2R1WA01#
					±0.1pF	GRM0333C1H2R1BA01#
					±0.25pF	GRM0333C1H2R1CA01#
			2.2pF	±0.05pF	GRM0333C1H2R2WA01#	
				±0.1pF	GRM0333C1H2R2BA01#	
				±0.25pF	GRM0333C1H2R2CA01#	
			2.3pF	±0.05pF	GRM0333C1H2R3WA01#	
				±0.1pF	GRM0333C1H2R3BA01#	
				±0.25pF	GRM0333C1H2R3CA01#	
			2.4pF	±0.05pF	GRM0333C1H2R4WA01#	
				±0.1pF	GRM0333C1H2R4BA01#	
				±0.25pF	GRM0333C1H2R4CA01#	
			2.5pF	±0.05pF	GRM0333C1H2R5WA01#	
				±0.1pF	GRM0333C1H2R5BA01#	
				±0.25pF	GRM0333C1H2R5CA01#	
		2.6pF	±0.05pF	GRM0333C1H2R6WA01#		
			±0.1pF	GRM0333C1H2R6BA01#		
			±0.25pF	GRM0333C1H2R6CA01#		
		2.7pF	±0.05pF	GRM0333C1H2R7WA01#		
			±0.1pF	GRM0333C1H2R7BA01#		
			±0.25pF	GRM0333C1H2R7CA01#		
		2.8pF	±0.05pF	GRM0333C1H2R8WA01#		
			±0.1pF	GRM0333C1H2R8BA01#		
			±0.25pF	GRM0333C1H2R8CA01#		
		2.9pF	±0.05pF	GRM0333C1H2R9WA01#		
			±0.1pF	GRM0333C1H2R9BA01#		
			±0.25pF	GRM0333C1H2R9CA01#		
		3.0pF	±0.05pF	GRM0333C1H3R0WA01#		
			±0.1pF	GRM0333C1H3R0BA01#		
			±0.25pF	GRM0333C1H3R0CA01#		
		3.1pF	±0.05pF	GRM0333C1H3R1WA01#		
			±0.1pF	GRM0333C1H3R1BA01#		
			±0.25pF	GRM0333C1H3R1CA01#		
		3.2pF	±0.05pF	GRM0333C1H3R2WA01#		
			±0.1pF	GRM0333C1H3R2BA01#		
			±0.25pF	GRM0333C1H3R2CA01#		
		3.3pF	±0.05pF	GRM0333C1H3R3WA01#		
			±0.1pF	GRM0333C1H3R3BA01#		
			±0.25pF	GRM0333C1H3R3CA01#		
3.4pF	±0.05pF	GRM0333C1H3R4WA01#				
	±0.1pF	GRM0333C1H3R4BA01#				
	±0.25pF	GRM0333C1H3R4CA01#				
3.5pF	±0.05pF	GRM0333C1H3R5WA01#				
	±0.1pF	GRM0333C1H3R5BA01#				
	±0.25pF	GRM0333C1H3R5CA01#				

Part number # indicates the package specification code.

For General Purpose GRM Series

Capacitor Array GNM Series

Low ESL LLI Series

High-Q Type GJM Series

High Frequency GQM Series

Monolithic Microchip GMA Series

For Bonding GMD Series

Product Information

## GRM Series Temperature Compensating Type Part Number List

(→ ■ 0.6x0.3mm)

T max.	Rated Voltage	TC Code	Cap.	Tol.	Part Number	
0.33mm	50Vdc	CJ	3.6pF	±0.05pF	GRM0333C1H3R6WA01#	
				±0.1pF	GRM0333C1H3R6BA01#	
				±0.25pF	GRM0333C1H3R6CA01#	
			3.7pF	±0.05pF	GRM0333C1H3R7WA01#	
				±0.1pF	GRM0333C1H3R7BA01#	
				±0.25pF	GRM0333C1H3R7CA01#	
			3.8pF	±0.05pF	GRM0333C1H3R8WA01#	
				±0.1pF	GRM0333C1H3R8BA01#	
				±0.25pF	GRM0333C1H3R8CA01#	
			3.9pF	±0.05pF	GRM0333C1H3R9WA01#	
				±0.1pF	GRM0333C1H3R9BA01#	
				±0.25pF	GRM0333C1H3R9CA01#	
			CH	4.0pF	±0.05pF	GRM0332C1H4R0WA01#
					±0.1pF	GRM0332C1H4R0BA01#
					±0.25pF	GRM0332C1H4R0CA01#
				4.1pF	±0.05pF	GRM0332C1H4R1WA01#
					±0.1pF	GRM0332C1H4R1BA01#
					±0.25pF	GRM0332C1H4R1CA01#
		4.2pF		±0.05pF	GRM0332C1H4R2WA01#	
				±0.1pF	GRM0332C1H4R2BA01#	
				±0.25pF	GRM0332C1H4R2CA01#	
		4.3pF		±0.05pF	GRM0332C1H4R3WA01#	
				±0.1pF	GRM0332C1H4R3BA01#	
				±0.25pF	GRM0332C1H4R3CA01#	
		4.4pF		±0.05pF	GRM0332C1H4R4WA01#	
				±0.1pF	GRM0332C1H4R4BA01#	
				±0.25pF	GRM0332C1H4R4CA01#	
		4.5pF		±0.05pF	GRM0332C1H4R5WA01#	
				±0.1pF	GRM0332C1H4R5BA01#	
				±0.25pF	GRM0332C1H4R5CA01#	
		4.6pF		±0.05pF	GRM0332C1H4R6WA01#	
				±0.1pF	GRM0332C1H4R6BA01#	
				±0.25pF	GRM0332C1H4R6CA01#	
		4.7pF		±0.05pF	GRM0332C1H4R7WA01#	
				±0.1pF	GRM0332C1H4R7BA01#	
				±0.25pF	GRM0332C1H4R7CA01#	
		4.8pF		±0.05pF	GRM0332C1H4R8WA01#	
				±0.1pF	GRM0332C1H4R8BA01#	
				±0.25pF	GRM0332C1H4R8CA01#	
		4.9pF		±0.05pF	GRM0332C1H4R9WA01#	
				±0.1pF	GRM0332C1H4R9BA01#	
				±0.25pF	GRM0332C1H4R9CA01#	
		5.0pF		±0.05pF	GRM0332C1H5R0WA01#	
				±0.1pF	GRM0332C1H5R0BA01#	
				±0.25pF	GRM0332C1H5R0CA01#	
		5.1pF		±0.05pF	GRM0332C1H5R1WA01#	
				±0.1pF	GRM0332C1H5R1BA01#	
				±0.25pF	GRM0332C1H5R1CA01#	
			±0.5pF	GRM0332C1H5R1DA01#		
		5.2pF	±0.05pF	GRM0332C1H5R2WA01#		
			±0.1pF	GRM0332C1H5R2BA01#		
			±0.25pF	GRM0332C1H5R2CA01#		
			±0.5pF	GRM0332C1H5R2DA01#		
		5.3pF	±0.05pF	GRM0332C1H5R3WA01#		

T max.	Rated Voltage	TC Code	Cap.	Tol.	Part Number
0.33mm	50Vdc	CH	5.3pF	±0.1pF	GRM0332C1H5R3BA01#
				±0.25pF	GRM0332C1H5R3CA01#
				±0.5pF	GRM0332C1H5R3DA01#
			5.4pF	±0.05pF	GRM0332C1H5R4WA01#
				±0.1pF	GRM0332C1H5R4BA01#
				±0.25pF	GRM0332C1H5R4CA01#
			5.5pF	±0.05pF	GRM0332C1H5R5WA01#
				±0.1pF	GRM0332C1H5R5BA01#
				±0.25pF	GRM0332C1H5R5CA01#
			5.6pF	±0.05pF	GRM0332C1H5R6WA01#
				±0.1pF	GRM0332C1H5R6BA01#
				±0.25pF	GRM0332C1H5R6CA01#
			5.7pF	±0.05pF	GRM0332C1H5R7WA01#
				±0.1pF	GRM0332C1H5R7BA01#
				±0.25pF	GRM0332C1H5R7CA01#
			5.8pF	±0.05pF	GRM0332C1H5R8WA01#
				±0.1pF	GRM0332C1H5R8BA01#
				±0.25pF	GRM0332C1H5R8CA01#
			5.9pF	±0.05pF	GRM0332C1H5R9WA01#
				±0.1pF	GRM0332C1H5R9BA01#
				±0.25pF	GRM0332C1H5R9CA01#
			6.0pF	±0.05pF	GRM0332C1H6R0WA01#
				±0.1pF	GRM0332C1H6R0BA01#
				±0.25pF	GRM0332C1H6R0CA01#
			6.1pF	±0.05pF	GRM0332C1H6R1WA01#
				±0.1pF	GRM0332C1H6R1BA01#
				±0.25pF	GRM0332C1H6R1CA01#
			6.2pF	±0.05pF	GRM0332C1H6R2WA01#
				±0.1pF	GRM0332C1H6R2BA01#
				±0.25pF	GRM0332C1H6R2CA01#
			6.3pF	±0.05pF	GRM0332C1H6R3WA01#
				±0.1pF	GRM0332C1H6R3BA01#
				±0.25pF	GRM0332C1H6R3CA01#
			6.4pF	±0.05pF	GRM0332C1H6R4WA01#
				±0.1pF	GRM0332C1H6R4BA01#
				±0.25pF	GRM0332C1H6R4CA01#
			6.5pF	±0.05pF	GRM0332C1H6R5WA01#
				±0.1pF	GRM0332C1H6R5BA01#
				±0.25pF	GRM0332C1H6R5CA01#
			6.6pF	±0.05pF	GRM0332C1H6R6WA01#
				±0.1pF	GRM0332C1H6R6BA01#
				±0.25pF	GRM0332C1H6R6CA01#

Part number # indicates the package specification code.

## GRM Series Temperature Compensating Type Part Number List

(→ ■ 0.6x0.3mm)

T max.	Rated Voltage	TC Code	Cap.	Tol.	Part Number	
0.33mm	50Vdc	CH	6.6pF	±0.5pF	GRM0332C1H6R6DA01#	
				±0.05pF	GRM0332C1H6R7WA01#	
					±0.1pF	GRM0332C1H6R7BA01#
			±0.25pF		GRM0332C1H6R7CA01#	
			±0.5pF	GRM0332C1H6R7DA01#		
				6.8pF	±0.05pF	GRM0332C1H6R8WA01#
					±0.1pF	GRM0332C1H6R8BA01#
			±0.25pF		GRM0332C1H6R8CA01#	
			±0.5pF	GRM0332C1H6R8DA01#		
			6.9pF	±0.05pF	GRM0332C1H6R9WA01#	
				±0.1pF	GRM0332C1H6R9BA01#	
				±0.25pF	GRM0332C1H6R9CA01#	
			±0.5pF	GRM0332C1H6R9DA01#		
			7.0pF	±0.05pF	GRM0332C1H7R0WA01#	
				±0.1pF	GRM0332C1H7R0BA01#	
				±0.25pF	GRM0332C1H7R0CA01#	
			±0.5pF	GRM0332C1H7R0DA01#		
			7.1pF	±0.05pF	GRM0332C1H7R1WA01#	
				±0.1pF	GRM0332C1H7R1BA01#	
				±0.25pF	GRM0332C1H7R1CA01#	
			±0.5pF	GRM0332C1H7R1DA01#		
			7.2pF	±0.05pF	GRM0332C1H7R2WA01#	
				±0.1pF	GRM0332C1H7R2BA01#	
				±0.25pF	GRM0332C1H7R2CA01#	
			±0.5pF	GRM0332C1H7R2DA01#		
			7.3pF	±0.05pF	GRM0332C1H7R3WA01#	
				±0.1pF	GRM0332C1H7R3BA01#	
				±0.25pF	GRM0332C1H7R3CA01#	
			±0.5pF	GRM0332C1H7R3DA01#		
			7.4pF	±0.05pF	GRM0332C1H7R4WA01#	
				±0.1pF	GRM0332C1H7R4BA01#	
				±0.25pF	GRM0332C1H7R4CA01#	
			±0.5pF	GRM0332C1H7R4DA01#		
			7.5pF	±0.05pF	GRM0332C1H7R5WA01#	
				±0.1pF	GRM0332C1H7R5BA01#	
				±0.25pF	GRM0332C1H7R5CA01#	
			±0.5pF	GRM0332C1H7R5DA01#		
			7.6pF	±0.05pF	GRM0332C1H7R6WA01#	
				±0.1pF	GRM0332C1H7R6BA01#	
				±0.25pF	GRM0332C1H7R6CA01#	
			±0.5pF	GRM0332C1H7R6DA01#		
			7.7pF	±0.05pF	GRM0332C1H7R7WA01#	
				±0.1pF	GRM0332C1H7R7BA01#	
				±0.25pF	GRM0332C1H7R7CA01#	
			±0.5pF	GRM0332C1H7R7DA01#		
			7.8pF	±0.05pF	GRM0332C1H7R8WA01#	
				±0.1pF	GRM0332C1H7R8BA01#	
				±0.25pF	GRM0332C1H7R8CA01#	
±0.5pF	GRM0332C1H7R8DA01#					
7.9pF	±0.05pF	GRM0332C1H7R9WA01#				
	±0.1pF	GRM0332C1H7R9BA01#				
	±0.25pF	GRM0332C1H7R9CA01#				
±0.5pF	GRM0332C1H7R9DA01#					
8.0pF	±0.05pF	GRM0332C1H8R0WA01#				

T max.	Rated Voltage	TC Code	Cap.	Tol.	Part Number
0.33mm	50Vdc	CH	8.0pF	±0.1pF	GRM0332C1H8R0BA01#
				±0.25pF	GRM0332C1H8R0CA01#
				±0.5pF	GRM0332C1H8R0DA01#
			8.1pF	±0.05pF	GRM0332C1H8R1WA01#
				±0.1pF	GRM0332C1H8R1BA01#
				±0.25pF	GRM0332C1H8R1CA01#
			±0.5pF	GRM0332C1H8R1DA01#	
			8.2pF	±0.05pF	GRM0332C1H8R2WA01#
				±0.1pF	GRM0332C1H8R2BA01#
				±0.25pF	GRM0332C1H8R2CA01#
			±0.5pF	GRM0332C1H8R2DA01#	
			8.3pF	±0.05pF	GRM0332C1H8R3WA01#
				±0.1pF	GRM0332C1H8R3BA01#
				±0.25pF	GRM0332C1H8R3CA01#
			±0.5pF	GRM0332C1H8R3DA01#	
			8.4pF	±0.05pF	GRM0332C1H8R4WA01#
				±0.1pF	GRM0332C1H8R4BA01#
				±0.25pF	GRM0332C1H8R4CA01#
			±0.5pF	GRM0332C1H8R4DA01#	
			8.5pF	±0.05pF	GRM0332C1H8R5WA01#
				±0.1pF	GRM0332C1H8R5BA01#
				±0.25pF	GRM0332C1H8R5CA01#
			±0.5pF	GRM0332C1H8R5DA01#	
			8.6pF	±0.05pF	GRM0332C1H8R6WA01#
				±0.1pF	GRM0332C1H8R6BA01#
				±0.25pF	GRM0332C1H8R6CA01#
			±0.5pF	GRM0332C1H8R6DA01#	
			8.7pF	±0.05pF	GRM0332C1H8R7WA01#
				±0.1pF	GRM0332C1H8R7BA01#
				±0.25pF	GRM0332C1H8R7CA01#
			±0.5pF	GRM0332C1H8R7DA01#	
			8.8pF	±0.05pF	GRM0332C1H8R8WA01#
				±0.1pF	GRM0332C1H8R8BA01#
				±0.25pF	GRM0332C1H8R8CA01#
			±0.5pF	GRM0332C1H8R8DA01#	
			8.9pF	±0.05pF	GRM0332C1H8R9WA01#
				±0.1pF	GRM0332C1H8R9BA01#
				±0.25pF	GRM0332C1H8R9CA01#
			±0.5pF	GRM0332C1H8R9DA01#	
			9.0pF	±0.05pF	GRM0332C1H9R0WA01#
				±0.1pF	GRM0332C1H9R0BA01#
				±0.25pF	GRM0332C1H9R0CA01#
			±0.5pF	GRM0332C1H9R0DA01#	
			9.1pF	±0.05pF	GRM0332C1H9R1WA01#
				±0.1pF	GRM0332C1H9R1BA01#
				±0.25pF	GRM0332C1H9R1CA01#
			±0.5pF	GRM0332C1H9R1DA01#	
			9.2pF	±0.05pF	GRM0332C1H9R2WA01#
±0.1pF	GRM0332C1H9R2BA01#				
±0.25pF	GRM0332C1H9R2CA01#				
±0.5pF	GRM0332C1H9R2DA01#				
9.3pF	±0.05pF	GRM0332C1H9R3WA01#			
	±0.1pF	GRM0332C1H9R3BA01#			
	±0.25pF	GRM0332C1H9R3CA01#			

Part number # indicates the package specification code.

For General Purpose GRM Series

Capacitor Array GNM Series

Low ESL LLI Series

High-Q Type GJM Series

High Frequency GQM Series

Monolithic Microchip GMA Series

For Bonding GMD Series

Product Information

## GRM Series Temperature Compensating Type Part Number List

(→ ■ 0.6x0.3mm)

T max.	Rated Voltage	TC Code	Cap.	Tol.	Part Number	
0.33mm	50Vdc	CH	9.3pF	±0.5pF	GRM0332C1H9R3DA01#	
				±0.05pF	GRM0332C1H9R4WA01#	
					±0.1pF	GRM0332C1H9R4BA01#
					±0.25pF	GRM0332C1H9R4CA01#
					±0.5pF	GRM0332C1H9R4DA01#
			9.5pF	±0.05pF	GRM0332C1H9R5WA01#	
				±0.1pF	GRM0332C1H9R5BA01#	
				±0.25pF	GRM0332C1H9R5CA01#	
				±0.5pF	GRM0332C1H9R5DA01#	
			9.6pF	±0.05pF	GRM0332C1H9R6WA01#	
				±0.1pF	GRM0332C1H9R6BA01#	
				±0.25pF	GRM0332C1H9R6CA01#	
				±0.5pF	GRM0332C1H9R6DA01#	
			9.7pF	±0.05pF	GRM0332C1H9R7WA01#	
				±0.1pF	GRM0332C1H9R7BA01#	
				±0.25pF	GRM0332C1H9R7CA01#	
				±0.5pF	GRM0332C1H9R7DA01#	
			9.8pF	±0.05pF	GRM0332C1H9R8WA01#	
				±0.1pF	GRM0332C1H9R8BA01#	
				±0.25pF	GRM0332C1H9R8CA01#	
				±0.5pF	GRM0332C1H9R8DA01#	
			9.9pF	±0.05pF	GRM0332C1H9R9WA01#	
				±0.1pF	GRM0332C1H9R9BA01#	
				±0.25pF	GRM0332C1H9R9CA01#	
				±0.5pF	GRM0332C1H9R9DA01#	
			10pF	±2%	GRM0332C1H100GA01#	
				±5%	GRM0332C1H100JA01#	
			12pF	±2%	GRM0332C1H120GA01#	
				±5%	GRM0332C1H120JA01#	
			15pF	±2%	GRM0332C1H150GA01#	
				±5%	GRM0332C1H150JA01#	
			18pF	±2%	GRM0332C1H180GA01#	
				±5%	GRM0332C1H180JA01#	
			22pF	±2%	GRM0332C1H220GA01#	
				±5%	GRM0332C1H220JA01#	
			27pF	±2%	GRM0332C1H270GA01#	
				±5%	GRM0332C1H270JA01#	
			33pF	±2%	GRM0332C1H330GA01#	
				±5%	GRM0332C1H330JA01#	
			39pF	±2%	GRM0332C1H390GA01#	
				±5%	GRM0332C1H390JA01#	
			47pF	±2%	GRM0332C1H470GA01#	
				±5%	GRM0332C1H470JA01#	
			56pF	±2%	GRM0332C1H560GA01#	
				±5%	GRM0332C1H560JA01#	
			68pF	±2%	GRM0332C1H680GA01#	
				±5%	GRM0332C1H680JA01#	
			82pF	±2%	GRM0332C1H820GA01#	
				±5%	GRM0332C1H820JA01#	
			100pF	±2%	GRM0332C1H101GA01#	
				±5%	GRM0332C1H101JA01#	
			UK	1.0pF	±0.25pF	GRM0334U1H1R0CD01#
				2.0pF	±0.25pF	GRM0334U1H2R0CD01#
			UJ	3.0pF	±0.25pF	GRM0333U1H3R0CD01#

T max.	Rated Voltage	TC Code	Cap.	Tol.	Part Number		
0.33mm	50Vdc	UJ	4.0pF	±0.25pF	GRM0333U1H4R0CD01#		
				±0.25pF	GRM0333U1H5R0CD01#		
				±0.5pF	GRM0333U1H6R0DD01#		
				±0.5pF	GRM0333U1H7R0DD01#		
				±0.5pF	GRM0333U1H8R0DD01#		
			9.0pF	±0.5pF	GRM0333U1H9R0DD01#		
				±5%	GRM0333U1H100JD01#		
				±5%	GRM0333U1H120JD01#		
				±5%	GRM0333U1H150JD01#		
				25Vdc	R2H	1.0pF	±0.25pF
			2.0pF			±0.25pF	GRM0336R1E2R0CD01#
			3.0pF			±0.25pF	GRM0336R1E3R0CD01#
			4.0pF			±0.25pF	GRM0336R1E4R0CD01#
			5.0pF			±0.25pF	GRM0336R1E5R0CD01#
			6.0pF			±0.5pF	GRM0336R1E6R0DD01#
			7.0pF			±0.5pF	GRM0336R1E7R0DD01#
			8.0pF			±0.5pF	GRM0336R1E8R0DD01#
			9.0pF			±0.5pF	GRM0336R1E9R0DD01#
			10pF			±5%	GRM0336R1E100JD01#
			12pF			±5%	GRM0336R1E120JD01#
			15pF			±5%	GRM0336R1E150JD01#
			18pF			±5%	GRM0336R1E180JD01#
			22pF			±5%	GRM0336R1E220JD01#
			27pF			±5%	GRM0336R1E270JD01#
			33pF	±5%	GRM0336R1E330JD01#		
			39pF	±5%	GRM0336R1E390JD01#		
			47pF	±5%	GRM0336R1E470JD01#		
			56pF	±5%	GRM0336R1E560JD01#		
			68pF	±5%	GRM0336R1E680JD01#		
			82pF	±5%	GRM0336R1E820JD01#		
			100pF	±5%	GRM0336R1E101JD01#		
			RK	1.0pF	±0.25pF	GRM0334R1E1R0CD01#	
					±0.25pF	GRM0334R1E2R0CD01#	
			RJ	3.0pF	±0.25pF	GRM0333R1E3R0CD01#	
			RH	4.0pF	±0.25pF	GRM0332R1E4R0CD01#	
				5.0pF	±0.25pF	GRM0332R1E5R0CD01#	
				6.0pF	±0.5pF	GRM0332R1E6R0DD01#	
				7.0pF	±0.5pF	GRM0332R1E7R0DD01#	
				8.0pF	±0.5pF	GRM0332R1E8R0DD01#	
				9.0pF	±0.5pF	GRM0332R1E9R0DD01#	
				10pF	±5%	GRM0332R1E100JD01#	
				12pF	±5%	GRM0332R1E120JD01#	
				15pF	±5%	GRM0332R1E150JD01#	
				18pF	±5%	GRM0332R1E180JD01#	
				22pF	±5%	GRM0332R1E220JD01#	
				27pF	±5%	GRM0332R1E270JD01#	
				33pF	±5%	GRM0332R1E330JD01#	
				39pF	±5%	GRM0332R1E390JD01#	
				47pF	±5%	GRM0332R1E470JD01#	
			56pF	±5%	GRM0332R1E560JD01#		
			68pF	±5%	GRM0332R1E680JD01#		
			82pF	±5%	GRM0332R1E820JD01#		
			100pF	±5%	GRM0332R1E101JD01#		
			S2H	1.0pF	±0.25pF	GRM0336S1E1R0CD01#	

Part number # indicates the package specification code.



# GRM Series Temperature Compensating Type Part Number List

(→ ■ 0.6x0.3mm)

T max.	Rated Voltage	TC Code	Cap.	Tol.	Part Number	
0.33mm	25Vdc	S2H	2.0pF	±0.25pF	GRM0336S1E2R0CD01#	
			3.0pF	±0.25pF	GRM0336S1E3R0CD01#	
			4.0pF	±0.25pF	GRM0336S1E4R0CD01#	
			5.0pF	±0.25pF	GRM0336S1E5R0CD01#	
			6.0pF	±0.5pF	GRM0336S1E6R0DD01#	
			7.0pF	±0.5pF	GRM0336S1E7R0DD01#	
			8.0pF	±0.5pF	GRM0336S1E8R0DD01#	
			9.0pF	±0.5pF	GRM0336S1E9R0DD01#	
			10pF	±5%	GRM0336S1E100JD01#	
			12pF	±5%	GRM0336S1E120JD01#	
			15pF	±5%	GRM0336S1E150JD01#	
			18pF	±5%	GRM0336S1E180JD01#	
			22pF	±5%	GRM0336S1E220JD01#	
			27pF	±5%	GRM0336S1E270JD01#	
			33pF	±5%	GRM0336S1E330JD01#	
			39pF	±5%	GRM0336S1E390JD01#	
			47pF	±5%	GRM0336S1E470JD01#	
			56pF	±5%	GRM0336S1E560JD01#	
			68pF	±5%	GRM0336S1E680JD01#	
			82pF	±5%	GRM0336S1E820JD01#	
			100pF	±5%	GRM0336S1E101JD01#	
			SK	1.0pF	±0.25pF	GRM0334S1E1R0CD01#
			2.0pF	±0.25pF	GRM0334S1E2R0CD01#	
			SJ	3.0pF	±0.25pF	GRM0333S1E3R0CD01#
			SH	4.0pF	±0.25pF	GRM0332S1E4R0CD01#
				5.0pF	±0.25pF	GRM0332S1E5R0CD01#
				6.0pF	±0.5pF	GRM0332S1E6R0DD01#
				7.0pF	±0.5pF	GRM0332S1E7R0DD01#
				8.0pF	±0.5pF	GRM0332S1E8R0DD01#
				9.0pF	±0.5pF	GRM0332S1E9R0DD01#
				10pF	±5%	GRM0332S1E100JD01#
				12pF	±5%	GRM0332S1E120JD01#
				15pF	±5%	GRM0332S1E150JD01#
				18pF	±5%	GRM0332S1E180JD01#
			22pF	±5%	GRM0332S1E220JD01#	
			27pF	±5%	GRM0332S1E270JD01#	
			33pF	±5%	GRM0332S1E330JD01#	
			39pF	±5%	GRM0332S1E390JD01#	
			47pF	±5%	GRM0332S1E470JD01#	
			56pF	±5%	GRM0332S1E560JD01#	
		68pF	±5%	GRM0332S1E680JD01#		
		82pF	±5%	GRM0332S1E820JD01#		
		100pF	±5%	GRM0332S1E101JD01#		
		T2H	1.0pF	±0.25pF	GRM0336T1E1R0CD01#	
			2.0pF	±0.25pF	GRM0336T1E2R0CD01#	
			3.0pF	±0.25pF	GRM0336T1E3R0CD01#	
			4.0pF	±0.25pF	GRM0336T1E4R0CD01#	
			5.0pF	±0.25pF	GRM0336T1E5R0CD01#	
			6.0pF	±0.5pF	GRM0336T1E6R0DD01#	
			7.0pF	±0.5pF	GRM0336T1E7R0DD01#	
			8.0pF	±0.5pF	GRM0336T1E8R0DD01#	
			9.0pF	±0.5pF	GRM0336T1E9R0DD01#	
			10pF	±5%	GRM0336T1E100JD01#	
			12pF	±5%	GRM0336T1E120JD01#	

T max.	Rated Voltage	TC Code	Cap.	Tol.	Part Number
0.33mm	25Vdc	T2H	15pF	±5%	GRM0336T1E150JD01#
			18pF	±5%	GRM0336T1E180JD01#
			22pF	±5%	GRM0336T1E220JD01#
			27pF	±5%	GRM0336T1E270JD01#
			33pF	±5%	GRM0336T1E330JD01#
			39pF	±5%	GRM0336T1E390JD01#
			47pF	±5%	GRM0336T1E470JD01#
			56pF	±5%	GRM0336T1E560JD01#
			68pF	±5%	GRM0336T1E680JD01#
			82pF	±5%	GRM0336T1E820JD01#
		100pF	±5%	GRM0336T1E101JD01#	
		TK	1.0pF	±0.25pF	GRM0334T1E1R0CD01#
			2.0pF	±0.25pF	GRM0334T1E2R0CD01#
		TJ	3.0pF	±0.25pF	GRM0333T1E3R0CD01#
		TH	4.0pF	±0.25pF	GRM0332T1E4R0CD01#
			5.0pF	±0.25pF	GRM0332T1E5R0CD01#
			6.0pF	±0.5pF	GRM0332T1E6R0DD01#
			7.0pF	±0.5pF	GRM0332T1E7R0DD01#
			8.0pF	±0.5pF	GRM0332T1E8R0DD01#
			9.0pF	±0.5pF	GRM0332T1E9R0DD01#
			10pF	±5%	GRM0332T1E100JD01#
			12pF	±5%	GRM0332T1E120JD01#
			15pF	±5%	GRM0332T1E150JD01#
			18pF	±5%	GRM0332T1E180JD01#
		22pF	±5%	GRM0332T1E220JD01#	
		27pF	±5%	GRM0332T1E270JD01#	
		33pF	±5%	GRM0332T1E330JD01#	
		39pF	±5%	GRM0332T1E390JD01#	
		47pF	±5%	GRM0332T1E470JD01#	
		56pF	±5%	GRM0332T1E560JD01#	
		68pF	±5%	GRM0332T1E680JD01#	
		82pF	±5%	GRM0332T1E820JD01#	
		100pF	±5%	GRM0332T1E101JD01#	
		UJ	18pF	±5%	GRM0333U1E180JD01#
			22pF	±5%	GRM0333U1E220JD01#
			27pF	±5%	GRM0333U1E270JD01#
			33pF	±5%	GRM0333U1E330JD01#
			39pF	±5%	GRM0333U1E390JD01#
			47pF	±5%	GRM0333U1E470JD01#
			56pF	±5%	GRM0333U1E560JD01#
			68pF	±5%	GRM0333U1E680JD01#
			82pF	±5%	GRM0333U1E820JD01#
			100pF	±5%	GRM0333U1E101JD01#

■ 1.0x0.5mm

T max.	Rated Voltage	TC Code	Cap.	Tol.	Part Number
0.33mm	50Vdc	C0G	0.1pF	±0.1pF	GRM1535C1HR10BDD5#
			0.2pF	±0.1pF	GRM1535C1HR20BDD5#
			0.3pF	±0.1pF	GRM1535C1HR30BDD5#
			0.4pF	±0.1pF	GRM1535C1HR40BDD5#
			0.5pF	±0.1pF	GRM1535C1HR50BDD5#
			0.6pF	±0.1pF	GRM1535C1HR60BDD5#

Part number # indicates the package specification code.

For General Purpose GRM Series  
 Capacitor Array GNM Series  
 Low ESL LLI Series  
 High-Q Type GJM Series  
 High Frequency GQM Series  
 Monolithic Microchip GMA Series  
 For Bonding GMD Series  
 Product Information

## GRM Series Temperature Compensating Type Part Number List

(→ ■ 1.0x0.5mm)

T max.	Rated Voltage	TC Code	Cap.	Tol.	Part Number
0.33mm	50Vdc	C0G	0.7pF	±0.1pF	GRM1535C1HR70BDD5#
			0.8pF	±0.1pF	GRM1535C1HR80BDD5#
			0.9pF	±0.1pF	GRM1535C1HR90BDD5#
			1.0pF	±0.25pF	GRM1535C1H1R0CDD5#
			1.1pF	±0.25pF	GRM1535C1H1R1CDD5#
			1.2pF	±0.25pF	GRM1535C1H1R2CDD5#
			1.3pF	±0.25pF	GRM1535C1H1R3CDD5#
			1.4pF	±0.25pF	GRM1535C1H1R4CDD5#
			1.5pF	±0.25pF	GRM1535C1H1R5CDD5#
			1.6pF	±0.25pF	GRM1535C1H1R6CDD5#
			1.7pF	±0.25pF	GRM1535C1H1R7CDD5#
			1.8pF	±0.25pF	GRM1535C1H1R8CDD5#
			1.9pF	±0.25pF	GRM1535C1H1R9CDD5#
			2.0pF	±0.25pF	GRM1535C1H2R0CDD5#
			2.1pF	±0.25pF	GRM1535C1H2R1CDD5#
			2.2pF	±0.25pF	GRM1535C1H2R2CDD5#
			2.3pF	±0.25pF	GRM1535C1H2R3CDD5#
			2.4pF	±0.25pF	GRM1535C1H2R4CDD5#
			2.5pF	±0.25pF	GRM1535C1H2R5CDD5#
			2.6pF	±0.25pF	GRM1535C1H2R6CDD5#
			2.7pF	±0.25pF	GRM1535C1H2R7CDD5#
			2.8pF	±0.25pF	GRM1535C1H2R8CDD5#
			2.9pF	±0.25pF	GRM1535C1H2R9CDD5#
			3.0pF	±0.25pF	GRM1535C1H3R0CDD5#
			3.1pF	±0.25pF	GRM1535C1H3R1CDD5#
			3.2pF	±0.25pF	GRM1535C1H3R2CDD5#
			3.3pF	±0.25pF	GRM1535C1H3R3CDD5#
			3.4pF	±0.25pF	GRM1535C1H3R4CDD5#
			3.5pF	±0.25pF	GRM1535C1H3R5CDD5#
			3.6pF	±0.25pF	GRM1535C1H3R6CDD5#
3.7pF	±0.25pF	GRM1535C1H3R7CDD5#			
3.8pF	±0.25pF	GRM1535C1H3R8CDD5#			
3.9pF	±0.25pF	GRM1535C1H3R9CDD5#			
4.0pF	±0.25pF	GRM1535C1H4R0CDD5#			
4.1pF	±0.25pF	GRM1535C1H4R1CDD5#			
4.2pF	±0.25pF	GRM1535C1H4R2CDD5#			
4.3pF	±0.25pF	GRM1535C1H4R3CDD5#			
4.4pF	±0.25pF	GRM1535C1H4R4CDD5#			
4.5pF	±0.25pF	GRM1535C1H4R5CDD5#			
4.6pF	±0.25pF	GRM1535C1H4R6CDD5#			
4.7pF	±0.25pF	GRM1535C1H4R7CDD5#			
4.8pF	±0.25pF	GRM1535C1H4R8CDD5#			
4.9pF	±0.25pF	GRM1535C1H4R9CDD5#			
5.0pF	±0.25pF	GRM1535C1H5R0CDD5#			
5.1pF	±0.5pF	GRM1535C1H5R1DDD5#			
5.2pF	±0.5pF	GRM1535C1H5R2DDD5#			
5.3pF	±0.5pF	GRM1535C1H5R3DDD5#			
5.4pF	±0.5pF	GRM1535C1H5R4DDD5#			
5.5pF	±0.5pF	GRM1535C1H5R5DDD5#			
5.6pF	±0.5pF	GRM1535C1H5R6DDD5#			
5.7pF	±0.5pF	GRM1535C1H5R7DDD5#			
5.8pF	±0.5pF	GRM1535C1H5R8DDD5#			
5.9pF	±0.5pF	GRM1535C1H5R9DDD5#			
6.0pF	±0.5pF	GRM1535C1H6R0DDD5#			

T max.	Rated Voltage	TC Code	Cap.	Tol.	Part Number
0.33mm	50Vdc	C0G	6.1pF	±0.5pF	GRM1535C1H6R1DDD5#
			6.2pF	±0.5pF	GRM1535C1H6R2DDD5#
			6.3pF	±0.5pF	GRM1535C1H6R3DDD5#
			6.4pF	±0.5pF	GRM1535C1H6R4DDD5#
			6.5pF	±0.5pF	GRM1535C1H6R5DDD5#
			6.6pF	±0.5pF	GRM1535C1H6R6DDD5#
			6.7pF	±0.5pF	GRM1535C1H6R7DDD5#
			6.8pF	±0.5pF	GRM1535C1H6R8DDD5#
			6.9pF	±0.5pF	GRM1535C1H6R9DDD5#
			7.0pF	±0.5pF	GRM1535C1H7R0DDD5#
			7.1pF	±0.5pF	GRM1535C1H7R1DDD5#
			7.2pF	±0.5pF	GRM1535C1H7R2DDD5#
			7.3pF	±0.5pF	GRM1535C1H7R3DDD5#
			7.4pF	±0.5pF	GRM1535C1H7R4DDD5#
			7.5pF	±0.5pF	GRM1535C1H7R5DDD5#
			7.6pF	±0.5pF	GRM1535C1H7R6DDD5#
			7.7pF	±0.5pF	GRM1535C1H7R7DDD5#
			7.8pF	±0.5pF	GRM1535C1H7R8DDD5#
			7.9pF	±0.5pF	GRM1535C1H7R9DDD5#
			8.0pF	±0.5pF	GRM1535C1H8R0DDD5#
			8.1pF	±0.5pF	GRM1535C1H8R1DDD5#
			8.2pF	±0.5pF	GRM1535C1H8R2DDD5#
			8.3pF	±0.5pF	GRM1535C1H8R3DDD5#
			8.4pF	±0.5pF	GRM1535C1H8R4DDD5#
			8.5pF	±0.5pF	GRM1535C1H8R5DDD5#
			8.6pF	±0.5pF	GRM1535C1H8R6DDD5#
			8.7pF	±0.5pF	GRM1535C1H8R7DDD5#
			8.8pF	±0.5pF	GRM1535C1H8R8DDD5#
			8.9pF	±0.5pF	GRM1535C1H8R9DDD5#
			9.0pF	±0.5pF	GRM1535C1H9R0DDD5#
9.1pF	±0.5pF	GRM1535C1H9R1DDD5#			
9.2pF	±0.5pF	GRM1535C1H9R2DDD5#			
9.3pF	±0.5pF	GRM1535C1H9R3DDD5#			
9.4pF	±0.5pF	GRM1535C1H9R4DDD5#			
9.5pF	±0.5pF	GRM1535C1H9R5DDD5#			
9.6pF	±0.5pF	GRM1535C1H9R6DDD5#			
9.7pF	±0.5pF	GRM1535C1H9R7DDD5#			
9.8pF	±0.5pF	GRM1535C1H9R8DDD5#			
9.9pF	±0.5pF	GRM1535C1H9R9DDD5#			
10pF	±5%	GRM1535C1H100JDD5#			
12pF	±5%	GRM1535C1H120JDD5#			
15pF	±5%	GRM1535C1H150JDD5#			
18pF	±5%	GRM1535C1H180JDD5#			
22pF	±5%	GRM1535C1H220JDD5#			
27pF	±5%	GRM1535C1H270JDD5#			
33pF	±5%	GRM1535C1H330JDD5#			
39pF	±5%	GRM1535C1H390JDD5#			
47pF	±5%	GRM1535C1H470JDD5#			
56pF	±5%	GRM1535C1H560JDD5#			
68pF	±5%	GRM1535C1H680JDD5#			
82pF	±5%	GRM1535C1H820JDD5#			
100pF	±5%	GRM1535C1H101JDD5#			
120pF	±5%	GRM1535C1H121JDD5#			
150pF	±5%	GRM1535C1H151JDD5#			

Part number # indicates the package specification code.

## GRM Series Temperature Compensating Type Part Number List

(→ ■ 1.0x0.5mm)

T max.	Rated Voltage	TC Code	Cap.	Tol.	Part Number	
0.33mm	50Vdc	COG	180pF	±5%	GRM1535C1H181JDD5#	
			220pF	±5%	GRM1535C1H221JDD5#	
			270pF	±5%	GRM1535C1H271JDD5#	
			330pF	±5%	GRM1535C1H331JDD5#	
			390pF	±5%	GRM1535C1H391JDD5#	
			470pF	±5%	GRM1535C1H471JDD5#	
			560pF	±5%	GRM1535C1H561JDD5#	
			680pF	±5%	GRM1535C1H681JDD5#	
		CK	0.1pF	±0.1pF	GRM1534C1HR10BDD5#	
			0.2pF	±0.1pF	GRM1534C1HR20BDD5#	
			0.3pF	±0.1pF	GRM1534C1HR30BDD5#	
			0.4pF	±0.1pF	GRM1534C1HR40BDD5#	
			0.5pF	±0.1pF	GRM1534C1HR50BDD5#	
			0.6pF	±0.1pF	GRM1534C1HR60BDD5#	
			0.7pF	±0.1pF	GRM1534C1HR70BDD5#	
			0.8pF	±0.1pF	GRM1534C1HR80BDD5#	
			0.9pF	±0.1pF	GRM1534C1HR90BDD5#	
			1.0pF	±0.25pF	GRM1534C1H1R0CDD5#	
			1.1pF	±0.25pF	GRM1534C1H1R1CDD5#	
			1.2pF	±0.25pF	GRM1534C1H1R2CDD5#	
			1.3pF	±0.25pF	GRM1534C1H1R3CDD5#	
			1.4pF	±0.25pF	GRM1534C1H1R4CDD5#	
			1.5pF	±0.25pF	GRM1534C1H1R5CDD5#	
			1.6pF	±0.25pF	GRM1534C1H1R6CDD5#	
			1.7pF	±0.25pF	GRM1534C1H1R7CDD5#	
			1.8pF	±0.25pF	GRM1534C1H1R8CDD5#	
			1.9pF	±0.25pF	GRM1534C1H1R9CDD5#	
			2.0pF	±0.25pF	GRM1534C1H2R0CDD5#	
			CJ	2.1pF	±0.25pF	GRM1533C1H2R1CDD5#
				2.2pF	±0.25pF	GRM1533C1H2R2CDD5#
				2.3pF	±0.25pF	GRM1533C1H2R3CDD5#
				2.4pF	±0.25pF	GRM1533C1H2R4CDD5#
				2.5pF	±0.25pF	GRM1533C1H2R5CDD5#
				2.6pF	±0.25pF	GRM1533C1H2R6CDD5#
				2.7pF	±0.25pF	GRM1533C1H2R7CDD5#
				2.8pF	±0.25pF	GRM1533C1H2R8CDD5#
				2.9pF	±0.25pF	GRM1533C1H2R9CDD5#
				3.0pF	±0.25pF	GRM1533C1H3R0CDD5#
				3.1pF	±0.25pF	GRM1533C1H3R1CDD5#
				3.2pF	±0.25pF	GRM1533C1H3R2CDD5#
		CH	3.3pF	±0.25pF	GRM1533C1H3R3CDD5#	
			3.4pF	±0.25pF	GRM1533C1H3R4CDD5#	
			3.5pF	±0.25pF	GRM1533C1H3R5CDD5#	
			3.6pF	±0.25pF	GRM1533C1H3R6CDD5#	
			3.7pF	±0.25pF	GRM1533C1H3R7CDD5#	
			3.8pF	±0.25pF	GRM1533C1H3R8CDD5#	
3.9pF	±0.25pF		GRM1533C1H3R9CDD5#			
4.0pF	±0.25pF		GRM1532C1H4R0CDD5#			
4.1pF	±0.25pF		GRM1532C1H4R1CDD5#			
4.2pF	±0.25pF		GRM1532C1H4R2CDD5#			
4.3pF	±0.25pF		GRM1532C1H4R3CDD5#			
4.4pF	±0.25pF		GRM1532C1H4R4CDD5#			
4.5pF	±0.25pF		GRM1532C1H4R5CDD5#			
4.6pF	±0.25pF		GRM1532C1H4R6CDD5#			

T max.	Rated Voltage	TC Code	Cap.	Tol.	Part Number
0.33mm	50Vdc	CH	4.7pF	±0.25pF	GRM1532C1H4R7CDD5#
			4.8pF	±0.25pF	GRM1532C1H4R8CDD5#
			4.9pF	±0.25pF	GRM1532C1H4R9CDD5#
			5.0pF	±0.25pF	GRM1532C1H5R0CDD5#
			5.1pF	±0.5pF	GRM1532C1H5R1DDD5#
			5.2pF	±0.5pF	GRM1532C1H5R2DDD5#
			5.3pF	±0.5pF	GRM1532C1H5R3DDD5#
			5.4pF	±0.5pF	GRM1532C1H5R4DDD5#
			5.5pF	±0.5pF	GRM1532C1H5R5DDD5#
			5.6pF	±0.5pF	GRM1532C1H5R6DDD5#
			5.7pF	±0.5pF	GRM1532C1H5R7DDD5#
			5.8pF	±0.5pF	GRM1532C1H5R8DDD5#
			5.9pF	±0.5pF	GRM1532C1H5R9DDD5#
			6.0pF	±0.5pF	GRM1532C1H6R0DDD5#
			6.1pF	±0.5pF	GRM1532C1H6R1DDD5#
			6.2pF	±0.5pF	GRM1532C1H6R2DDD5#
			6.3pF	±0.5pF	GRM1532C1H6R3DDD5#
			6.4pF	±0.5pF	GRM1532C1H6R4DDD5#
			6.5pF	±0.5pF	GRM1532C1H6R5DDD5#
			6.6pF	±0.5pF	GRM1532C1H6R6DDD5#
			6.7pF	±0.5pF	GRM1532C1H6R7DDD5#
			6.8pF	±0.5pF	GRM1532C1H6R8DDD5#
			6.9pF	±0.5pF	GRM1532C1H6R9DDD5#
			7.0pF	±0.5pF	GRM1532C1H7R0DDD5#
			7.1pF	±0.5pF	GRM1532C1H7R1DDD5#
			7.2pF	±0.5pF	GRM1532C1H7R2DDD5#
			7.3pF	±0.5pF	GRM1532C1H7R3DDD5#
			7.4pF	±0.5pF	GRM1532C1H7R4DDD5#
			7.5pF	±0.5pF	GRM1532C1H7R5DDD5#
			7.6pF	±0.5pF	GRM1532C1H7R6DDD5#
7.7pF	±0.5pF	GRM1532C1H7R7DDD5#			
7.8pF	±0.5pF	GRM1532C1H7R8DDD5#			
7.9pF	±0.5pF	GRM1532C1H7R9DDD5#			
8.0pF	±0.5pF	GRM1532C1H8R0DDD5#			
8.1pF	±0.5pF	GRM1532C1H8R1DDD5#			
8.2pF	±0.5pF	GRM1532C1H8R2DDD5#			
8.3pF	±0.5pF	GRM1532C1H8R3DDD5#			
8.4pF	±0.5pF	GRM1532C1H8R4DDD5#			
8.5pF	±0.5pF	GRM1532C1H8R5DDD5#			
8.6pF	±0.5pF	GRM1532C1H8R6DDD5#			
8.7pF	±0.5pF	GRM1532C1H8R7DDD5#			
8.8pF	±0.5pF	GRM1532C1H8R8DDD5#			
8.9pF	±0.5pF	GRM1532C1H8R9DDD5#			
9.0pF	±0.5pF	GRM1532C1H9R0DDD5#			
9.1pF	±0.5pF	GRM1532C1H9R1DDD5#			
9.2pF	±0.5pF	GRM1532C1H9R2DDD5#			
9.3pF	±0.5pF	GRM1532C1H9R3DDD5#			
9.4pF	±0.5pF	GRM1532C1H9R4DDD5#			
9.5pF	±0.5pF	GRM1532C1H9R5DDD5#			
9.6pF	±0.5pF	GRM1532C1H9R6DDD5#			
9.7pF	±0.5pF	GRM1532C1H9R7DDD5#			
9.8pF	±0.5pF	GRM1532C1H9R8DDD5#			
9.9pF	±0.5pF	GRM1532C1H9R9DDD5#			
10pF	±5%	GRM1532C1H100JDD5#			

Part number # indicates the package specification code.

For General Purpose GRM Series  
 Capacitor Array GNM Series  
 Low ESL LLI Series  
 High-Q Type GJM Series  
 High Frequency GQM Series  
 Monolithic Microchip GMA Series  
 For Bonding GMD Series  
 Product Information

## GRM Series Temperature Compensating Type Part Number List

(→ ■ 1.0x0.5mm)

T max.	Rated Voltage	TC Code	Cap.	Tol.	Part Number	T max.	Rated Voltage	TC Code	Cap.	Tol.	Part Number
0.33mm	50Vdc	CH	12pF	±5%	GRM1532C1H120JDD5#	0.55mm	50Vdc	C0G	1.4pF	±0.25pF	GRM1555C1H1R4CA01#
			15pF	±5%	GRM1532C1H150JDD5#				1.5pF	±0.05pF	GRM1555C1H1R5WA01#
			18pF	±5%	GRM1532C1H180JDD5#					±0.1pF	GRM1555C1H1R5BA01#
			22pF	±5%	GRM1532C1H220JDD5#					±0.25pF	GRM1555C1H1R5CA01#
			27pF	±5%	GRM1532C1H270JDD5#				1.6pF	±0.05pF	GRM1555C1H1R6WA01#
			33pF	±5%	GRM1532C1H330JDD5#					±0.1pF	GRM1555C1H1R6BA01#
			39pF	±5%	GRM1532C1H390JDD5#					±0.25pF	GRM1555C1H1R6CA01#
			47pF	±5%	GRM1532C1H470JDD5#				1.7pF	±0.05pF	GRM1555C1H1R7WA01#
			56pF	±5%	GRM1532C1H560JDD5#					±0.1pF	GRM1555C1H1R7BA01#
			68pF	±5%	GRM1532C1H680JDD5#					±0.25pF	GRM1555C1H1R7CA01#
			82pF	±5%	GRM1532C1H820JDD5#				1.8pF	±0.05pF	GRM1555C1H1R8WA01#
			100pF	±5%	GRM1532C1H101JDD5#					±0.1pF	GRM1555C1H1R8BA01#
			120pF	±5%	GRM1532C1H121JDD5#					±0.25pF	GRM1555C1H1R8CA01#
			150pF	±5%	GRM1532C1H151JDD5#				1.9pF	±0.05pF	GRM1555C1H1R9WA01#
			180pF	±5%	GRM1532C1H181JDD5#					±0.1pF	GRM1555C1H1R9BA01#
			220pF	±5%	GRM1532C1H221JDD5#					±0.25pF	GRM1555C1H1R9CA01#
			270pF	±5%	GRM1532C1H271JDD5#				2.0pF	±0.05pF	GRM1555C1H2R0WA01#
			330pF	±5%	GRM1532C1H331JDD5#					±0.1pF	GRM1555C1H2R0BA01#
			390pF	±5%	GRM1532C1H391JDD5#					±0.25pF	GRM1555C1H2R0CA01#
			470pF	±5%	GRM1532C1H471JDD5#				2.1pF	±0.05pF	GRM1555C1H2R1WA01#
560pF	±5%	GRM1532C1H561JDD5#		±0.1pF	GRM1555C1H2R1BA01#						
680pF	±5%	GRM1532C1H681JDD5#		±0.25pF	GRM1555C1H2R1CA01#						
0.55mm	50Vdc	C0G	0.1pF	±0.05pF	GRM1555C1HR10WA01#	2.2pF	±0.05pF	GRM1555C1H2R2WA01#			
				±0.1pF	GRM1555C1HR10BA01#		±0.1pF	GRM1555C1H2R2BA01#			
			0.2pF	±0.05pF	GRM1555C1HR20WA01#		±0.25pF	GRM1555C1H2R2CA01#			
				±0.1pF	GRM1555C1HR20BA01#	2.3pF	±0.05pF	GRM1555C1H2R3WA01#			
			0.3pF	±0.05pF	GRM1555C1HR30WA01#		±0.1pF	GRM1555C1H2R3BA01#			
				±0.1pF	GRM1555C1HR30BA01#		±0.25pF	GRM1555C1H2R3CA01#			
			0.4pF	±0.05pF	GRM1555C1HR40WA01#	2.4pF	±0.05pF	GRM1555C1H2R4WA01#			
				±0.1pF	GRM1555C1HR40BA01#		±0.1pF	GRM1555C1H2R4BA01#			
			0.5pF	±0.05pF	GRM1555C1HR50WA01#		±0.25pF	GRM1555C1H2R4CA01#			
				±0.1pF	GRM1555C1HR50BA01#	2.5pF	±0.05pF	GRM1555C1H2R5WA01#			
			0.6pF	±0.05pF	GRM1555C1HR60WA01#		±0.1pF	GRM1555C1H2R5BA01#			
				±0.1pF	GRM1555C1HR60BA01#		±0.25pF	GRM1555C1H2R5CA01#			
			0.7pF	±0.05pF	GRM1555C1HR70WA01#	2.6pF	±0.05pF	GRM1555C1H2R6WA01#			
				±0.1pF	GRM1555C1HR70BA01#		±0.1pF	GRM1555C1H2R6BA01#			
			0.8pF	±0.05pF	GRM1555C1HR80WA01#		±0.25pF	GRM1555C1H2R6CA01#			
				±0.1pF	GRM1555C1HR80BA01#	2.7pF	±0.05pF	GRM1555C1H2R7WA01#			
			0.9pF	±0.05pF	GRM1555C1HR90WA01#		±0.1pF	GRM1555C1H2R7BA01#			
				±0.1pF	GRM1555C1HR90BA01#		±0.25pF	GRM1555C1H2R7CA01#			
			1.0pF	±0.05pF	GRM1555C1H1R0WA01#	2.8pF	±0.05pF	GRM1555C1H2R8WA01#			
				±0.1pF	GRM1555C1H1R0BA01#		±0.1pF	GRM1555C1H2R8BA01#			
				±0.25pF	GRM1555C1H1R0CA01#		±0.25pF	GRM1555C1H2R8CA01#			
			1.1pF	±0.05pF	GRM1555C1H1R1WA01#	2.9pF	±0.05pF	GRM1555C1H2R9WA01#			
				±0.1pF	GRM1555C1H1R1BA01#		±0.1pF	GRM1555C1H2R9BA01#			
				±0.25pF	GRM1555C1H1R1CA01#		±0.25pF	GRM1555C1H2R9CA01#			
			1.2pF	±0.05pF	GRM1555C1H1R2WA01#	3.0pF	±0.05pF	GRM1555C1H3R0WA01#			
				±0.1pF	GRM1555C1H1R2BA01#		±0.1pF	GRM1555C1H3R0BA01#			
				±0.25pF	GRM1555C1H1R2CA01#		±0.25pF	GRM1555C1H3R0CA01#			
			1.3pF	±0.05pF	GRM1555C1H1R3WA01#	3.1pF	±0.05pF	GRM1555C1H3R1WA01#			
				±0.1pF	GRM1555C1H1R3BA01#		±0.1pF	GRM1555C1H3R1BA01#			
				±0.25pF	GRM1555C1H1R3CA01#		±0.25pF	GRM1555C1H3R1CA01#			
			1.4pF	±0.05pF	GRM1555C1H1R4WA01#	3.2pF	±0.05pF	GRM1555C1H3R2WA01#			
				±0.1pF	GRM1555C1H1R4BA01#		±0.1pF	GRM1555C1H3R2BA01#			

Part number # indicates the package specification code.



## GRM Series Temperature Compensating Type Part Number List

(→ ■ 1.0x0.5mm)

T max.	Rated Voltage	TC Code	Cap.	Tol.	Part Number	
0.55mm	50Vdc	C0G	3.2pF	±0.25pF	GRM1555C1H3R2CA01#	
				±0.05pF	GRM1555C1H3R3WA01#	
					±0.1pF	GRM1555C1H3R3BA01#
			±0.25pF	GRM1555C1H3R3CA01#		
				3.4pF	±0.05pF	GRM1555C1H3R4WA01#
					±0.1pF	GRM1555C1H3R4BA01#
			±0.25pF		GRM1555C1H3R4CA01#	
			3.5pF	±0.05pF	GRM1555C1H3R5WA01#	
				±0.1pF	GRM1555C1H3R5BA01#	
				±0.25pF	GRM1555C1H3R5CA01#	
			3.6pF	±0.05pF	GRM1555C1H3R6WA01#	
				±0.1pF	GRM1555C1H3R6BA01#	
				±0.25pF	GRM1555C1H3R6CA01#	
			3.7pF	±0.05pF	GRM1555C1H3R7WA01#	
				±0.1pF	GRM1555C1H3R7BA01#	
				±0.25pF	GRM1555C1H3R7CA01#	
			3.8pF	±0.05pF	GRM1555C1H3R8WA01#	
				±0.1pF	GRM1555C1H3R8BA01#	
				±0.25pF	GRM1555C1H3R8CA01#	
			3.9pF	±0.05pF	GRM1555C1H3R9WA01#	
				±0.1pF	GRM1555C1H3R9BA01#	
				±0.25pF	GRM1555C1H3R9CA01#	
			4.0pF	±0.05pF	GRM1555C1H4R0WA01#	
				±0.1pF	GRM1555C1H4R0BA01#	
				±0.25pF	GRM1555C1H4R0CA01#	
			4.1pF	±0.05pF	GRM1555C1H4R1WA01#	
				±0.1pF	GRM1555C1H4R1BA01#	
				±0.25pF	GRM1555C1H4R1CA01#	
			4.2pF	±0.05pF	GRM1555C1H4R2WA01#	
				±0.1pF	GRM1555C1H4R2BA01#	
				±0.25pF	GRM1555C1H4R2CA01#	
			4.3pF	±0.05pF	GRM1555C1H4R3WA01#	
				±0.1pF	GRM1555C1H4R3BA01#	
				±0.25pF	GRM1555C1H4R3CA01#	
			4.4pF	±0.05pF	GRM1555C1H4R4WA01#	
				±0.1pF	GRM1555C1H4R4BA01#	
				±0.25pF	GRM1555C1H4R4CA01#	
			4.5pF	±0.05pF	GRM1555C1H4R5WA01#	
				±0.1pF	GRM1555C1H4R5BA01#	
				±0.25pF	GRM1555C1H4R5CA01#	
			4.6pF	±0.05pF	GRM1555C1H4R6WA01#	
				±0.1pF	GRM1555C1H4R6BA01#	
				±0.25pF	GRM1555C1H4R6CA01#	
			4.7pF	±0.05pF	GRM1555C1H4R7WA01#	
				±0.1pF	GRM1555C1H4R7BA01#	
				±0.25pF	GRM1555C1H4R7CA01#	
			4.8pF	±0.05pF	GRM1555C1H4R8WA01#	
				±0.1pF	GRM1555C1H4R8BA01#	
				±0.25pF	GRM1555C1H4R8CA01#	
			4.9pF	±0.05pF	GRM1555C1H4R9WA01#	
				±0.1pF	GRM1555C1H4R9BA01#	
				±0.25pF	GRM1555C1H4R9CA01#	
			5.0pF	±0.05pF	GRM1555C1H5R0WA01#	
				±0.1pF	GRM1555C1H5R0BA01#	

T max.	Rated Voltage	TC Code	Cap.	Tol.	Part Number	
0.55mm	50Vdc	C0G	5.0pF	±0.25pF	GRM1555C1H5R0CA01#	
				±0.05pF	GRM1555C1H5R1WA01#	
					±0.1pF	GRM1555C1H5R1BA01#
			±0.25pF	GRM1555C1H5R1CA01#		
				5.2pF	±0.05pF	GRM1555C1H5R2WA01#
					±0.1pF	GRM1555C1H5R2BA01#
			±0.25pF		GRM1555C1H5R2CA01#	
			±0.5pF	GRM1555C1H5R2DA01#		
				5.3pF	±0.05pF	GRM1555C1H5R3WA01#
					±0.1pF	GRM1555C1H5R3BA01#
			±0.25pF		GRM1555C1H5R3CA01#	
			±0.5pF	GRM1555C1H5R3DA01#		
				5.4pF	±0.05pF	GRM1555C1H5R4WA01#
					±0.1pF	GRM1555C1H5R4BA01#
			±0.25pF		GRM1555C1H5R4CA01#	
			±0.5pF	GRM1555C1H5R4DA01#		
				5.5pF	±0.05pF	GRM1555C1H5R5WA01#
					±0.1pF	GRM1555C1H5R5BA01#
			±0.25pF		GRM1555C1H5R5CA01#	
			±0.5pF	GRM1555C1H5R5DA01#		
				5.6pF	±0.05pF	GRM1555C1H5R6WA01#
					±0.1pF	GRM1555C1H5R6BA01#
			±0.25pF		GRM1555C1H5R6CA01#	
			±0.5pF	GRM1555C1H5R6DA01#		
				5.7pF	±0.05pF	GRM1555C1H5R7WA01#
					±0.1pF	GRM1555C1H5R7BA01#
			±0.25pF		GRM1555C1H5R7CA01#	
			±0.5pF	GRM1555C1H5R7DA01#		
				5.8pF	±0.05pF	GRM1555C1H5R8WA01#
					±0.1pF	GRM1555C1H5R8BA01#
			±0.25pF		GRM1555C1H5R8CA01#	
			±0.5pF	GRM1555C1H5R8DA01#		
				5.9pF	±0.05pF	GRM1555C1H5R9WA01#
					±0.1pF	GRM1555C1H5R9BA01#
			±0.25pF		GRM1555C1H5R9CA01#	
			±0.5pF	GRM1555C1H5R9DA01#		
				6.0pF	±0.05pF	GRM1555C1H6R0WA01#
					±0.1pF	GRM1555C1H6R0BA01#
			±0.25pF		GRM1555C1H6R0CA01#	
			±0.5pF	GRM1555C1H6R0DA01#		
				6.1pF	±0.05pF	GRM1555C1H6R1WA01#
					±0.1pF	GRM1555C1H6R1BA01#
			±0.25pF		GRM1555C1H6R1CA01#	
			±0.5pF	GRM1555C1H6R1DA01#		
				6.2pF	±0.05pF	GRM1555C1H6R2WA01#
					±0.1pF	GRM1555C1H6R2BA01#
			±0.25pF		GRM1555C1H6R2CA01#	
			±0.5pF	GRM1555C1H6R2DA01#		
				6.3pF	±0.05pF	GRM1555C1H6R3WA01#
					±0.1pF	GRM1555C1H6R3BA01#
			±0.25pF		GRM1555C1H6R3CA01#	
			±0.5pF	GRM1555C1H6R3DA01#		
				6.4pF	±0.05pF	GRM1555C1H6R4WA01#

Part number # indicates the package specification code.

For General Purpose GRM Series

Capacitor Array GNM Series

Low ESL LLI Series

High-Q Type GJM Series

High Frequency GQM Series

Monolithic Microchip GMA Series

For Bonding GMD Series

Product Information

## GRM Series Temperature Compensating Type Part Number List

(→ ■ 1.0x0.5mm)

T max.	Rated Voltage	TC Code	Cap.	Tol.	Part Number
0.55mm	50Vdc	C0G	6.4pF	±0.1pF	GRM1555C1H6R4BA01#
				±0.25pF	GRM1555C1H6R4CA01#
				±0.5pF	GRM1555C1H6R4DA01#
			6.5pF	±0.05pF	GRM1555C1H6R5WA01#
				±0.1pF	GRM1555C1H6R5BA01#
				±0.25pF	GRM1555C1H6R5CA01#
			6.6pF	±0.05pF	GRM1555C1H6R6WA01#
				±0.1pF	GRM1555C1H6R6BA01#
				±0.25pF	GRM1555C1H6R6CA01#
			6.7pF	±0.05pF	GRM1555C1H6R7WA01#
				±0.1pF	GRM1555C1H6R7BA01#
				±0.25pF	GRM1555C1H6R7CA01#
			6.8pF	±0.05pF	GRM1555C1H6R8WA01#
				±0.1pF	GRM1555C1H6R8BA01#
				±0.25pF	GRM1555C1H6R8CA01#
			6.9pF	±0.05pF	GRM1555C1H6R9WA01#
				±0.1pF	GRM1555C1H6R9BA01#
				±0.25pF	GRM1555C1H6R9CA01#
			7.0pF	±0.05pF	GRM1555C1H7R0WA01#
				±0.1pF	GRM1555C1H7R0BA01#
				±0.25pF	GRM1555C1H7R0CA01#
			7.1pF	±0.05pF	GRM1555C1H7R1WA01#
				±0.1pF	GRM1555C1H7R1BA01#
				±0.25pF	GRM1555C1H7R1CA01#
			7.2pF	±0.05pF	GRM1555C1H7R2WA01#
				±0.1pF	GRM1555C1H7R2BA01#
				±0.25pF	GRM1555C1H7R2CA01#
			7.3pF	±0.05pF	GRM1555C1H7R3WA01#
				±0.1pF	GRM1555C1H7R3BA01#
				±0.25pF	GRM1555C1H7R3CA01#
			7.4pF	±0.05pF	GRM1555C1H7R4WA01#
				±0.1pF	GRM1555C1H7R4BA01#
				±0.25pF	GRM1555C1H7R4CA01#
			7.5pF	±0.05pF	GRM1555C1H7R5WA01#
				±0.1pF	GRM1555C1H7R5BA01#
				±0.25pF	GRM1555C1H7R5CA01#
			7.6pF	±0.05pF	GRM1555C1H7R6WA01#
				±0.1pF	GRM1555C1H7R6BA01#
				±0.25pF	GRM1555C1H7R6CA01#
			7.7pF	±0.05pF	GRM1555C1H7R7WA01#
				±0.1pF	GRM1555C1H7R7BA01#
				±0.25pF	GRM1555C1H7R7CA01#

T max.	Rated Voltage	TC Code	Cap.	Tol.	Part Number
0.55mm	50Vdc	C0G	7.7pF	±0.5pF	GRM1555C1H7R7DA01#
				±0.05pF	GRM1555C1H7R8WA01#
				±0.1pF	GRM1555C1H7R8BA01#
			7.8pF	±0.25pF	GRM1555C1H7R8CA01#
				±0.5pF	GRM1555C1H7R8DA01#
				7.9pF	±0.05pF
			±0.1pF		GRM1555C1H7R9BA01#
			±0.25pF		GRM1555C1H7R9CA01#
			8.0pF	±0.05pF	GRM1555C1H8R0WA01#
				±0.1pF	GRM1555C1H8R0BA01#
				±0.25pF	GRM1555C1H8R0CA01#
			8.1pF	±0.05pF	GRM1555C1H8R1WA01#
				±0.1pF	GRM1555C1H8R1BA01#
				±0.25pF	GRM1555C1H8R1CA01#
			8.2pF	±0.05pF	GRM1555C1H8R2WA01#
				±0.1pF	GRM1555C1H8R2BA01#
				±0.25pF	GRM1555C1H8R2CA01#
			8.3pF	±0.05pF	GRM1555C1H8R3WA01#
				±0.1pF	GRM1555C1H8R3BA01#
				±0.25pF	GRM1555C1H8R3CA01#
			8.4pF	±0.05pF	GRM1555C1H8R4WA01#
				±0.1pF	GRM1555C1H8R4BA01#
				±0.25pF	GRM1555C1H8R4CA01#
			8.5pF	±0.05pF	GRM1555C1H8R5WA01#
				±0.1pF	GRM1555C1H8R5BA01#
				±0.25pF	GRM1555C1H8R5CA01#
			8.6pF	±0.05pF	GRM1555C1H8R6WA01#
				±0.1pF	GRM1555C1H8R6BA01#
				±0.25pF	GRM1555C1H8R6CA01#
			8.7pF	±0.05pF	GRM1555C1H8R7WA01#
				±0.1pF	GRM1555C1H8R7BA01#
				±0.25pF	GRM1555C1H8R7CA01#
			8.8pF	±0.05pF	GRM1555C1H8R8WA01#
				±0.1pF	GRM1555C1H8R8BA01#
				±0.25pF	GRM1555C1H8R8CA01#
			8.9pF	±0.05pF	GRM1555C1H8R9WA01#
				±0.1pF	GRM1555C1H8R9BA01#
				±0.25pF	GRM1555C1H8R9CA01#
			9.0pF	±0.05pF	GRM1555C1H9R0WA01#
				±0.1pF	GRM1555C1H9R0BA01#
				±0.25pF	GRM1555C1H9R0CA01#
			9.1pF	±0.05pF	GRM1555C1H9R1WA01#
				±0.1pF	GRM1555C1H9R1BA01#
				±0.25pF	GRM1555C1H9R1CA01#

Part number # indicates the package specification code.

## GRM Series Temperature Compensating Type Part Number List

(→ ■ 1.0x0.5mm)

T max.	Rated Voltage	TC Code	Cap.	Tol.	Part Number
0.55mm	50Vdc	C0G	9.1pF	±0.1pF	GRM1555C1H9R1BA01#
				±0.25pF	GRM1555C1H9R1CA01#
				±0.5pF	GRM1555C1H9R1DA01#
			9.2pF	±0.05pF	GRM1555C1H9R2WA01#
				±0.1pF	GRM1555C1H9R2BA01#
				±0.25pF	GRM1555C1H9R2CA01#
			9.3pF	±0.05pF	GRM1555C1H9R3WA01#
				±0.1pF	GRM1555C1H9R3BA01#
				±0.25pF	GRM1555C1H9R3CA01#
			9.4pF	±0.05pF	GRM1555C1H9R4WA01#
				±0.1pF	GRM1555C1H9R4BA01#
				±0.25pF	GRM1555C1H9R4CA01#
			9.5pF	±0.05pF	GRM1555C1H9R5WA01#
				±0.1pF	GRM1555C1H9R5BA01#
				±0.25pF	GRM1555C1H9R5CA01#
			9.6pF	±0.05pF	GRM1555C1H9R6WA01#
				±0.1pF	GRM1555C1H9R6BA01#
				±0.25pF	GRM1555C1H9R6CA01#
			9.7pF	±0.05pF	GRM1555C1H9R7WA01#
				±0.1pF	GRM1555C1H9R7BA01#
				±0.25pF	GRM1555C1H9R7CA01#
			9.8pF	±0.05pF	GRM1555C1H9R8WA01#
				±0.1pF	GRM1555C1H9R8BA01#
				±0.25pF	GRM1555C1H9R8CA01#
			9.9pF	±0.05pF	GRM1555C1H9R9WA01#
				±0.1pF	GRM1555C1H9R9BA01#
				±0.25pF	GRM1555C1H9R9CA01#
			10pF	±2%	GRM1555C1H100GA01#
				±5%	GRM1555C1H100JA01#
			12pF	±2%	GRM1555C1H120GA01#
				±5%	GRM1555C1H120JA01#
			15pF	±2%	GRM1555C1H150GA01#
				±5%	GRM1555C1H150JA01#
			18pF	±2%	GRM1555C1H180GA01#
				±5%	GRM1555C1H180JA01#
			22pF	±2%	GRM1555C1H220GA01#
				±5%	GRM1555C1H220JA01#
			27pF	±2%	GRM1555C1H270GA01#
				±5%	GRM1555C1H270JA01#
			33pF	±2%	GRM1555C1H330GA01#
				±5%	GRM1555C1H330JA01#
			39pF	±2%	GRM1555C1H390GA01#
				±5%	GRM1555C1H390JA01#
			47pF	±2%	GRM1555C1H470GA01#
				±5%	GRM1555C1H470JA01#
			56pF	±2%	GRM1555C1H560GA01#

T max.	Rated Voltage	TC Code	Cap.	Tol.	Part Number			
0.55mm	50Vdc	C0G	56pF	±5%	GRM1555C1H560JA01#			
				±2%	GRM1555C1H680GA01#			
			68pF	±2%	GRM1555C1H680JA01#			
				±5%	GRM1555C1H680JA01#			
			82pF	±2%	GRM1555C1H820GA01#			
				±5%	GRM1555C1H820JA01#			
			100pF	±2%	GRM1555C1H101GA01#			
				±5%	GRM1555C1H101JA01#			
			120pF	±2%	GRM1555C1H121GA01#			
				±5%	GRM1555C1H121JA01#			
			150pF	±2%	GRM1555C1H151GA01#			
				±5%	GRM1555C1H151JA01#			
			180pF	±2%	GRM1555C1H181GA01#			
				±5%	GRM1555C1H181JA01#			
			220pF	±2%	GRM1555C1H221GA01#			
				±5%	GRM1555C1H221JA01#			
			270pF	±2%	GRM1555C1H271GA01#			
				±5%	GRM1555C1H271JA01#			
			330pF	±2%	GRM1555C1H331GA01#			
				±5%	GRM1555C1H331JA01#			
			390pF	±2%	GRM1555C1H391GA01#			
				±5%	GRM1555C1H391JA01#			
			470pF	±2%	GRM1555C1H471GA01#			
				±5%	GRM1555C1H471JA01#			
			560pF	±2%	GRM1555C1H561GA01#			
				±5%	GRM1555C1H561JA01#			
			680pF	±2%	GRM1555C1H681GA01#			
				±5%	GRM1555C1H681JA01#			
			820pF	±2%	GRM1555C1H821GA01#			
				±5%	GRM1555C1H821JA01#			
			1000pF	±2%	GRM1555C1H102GA01#			
				±5%	GRM1555C1H102JA01#			
			CK			0.1pF	±0.05pF	GRM1554C1HR10WA01#
							±0.1pF	GRM1554C1HR10BA01#
						0.2pF	±0.05pF	GRM1554C1HR20WA01#
							±0.1pF	GRM1554C1HR20BA01#
						0.3pF	±0.05pF	GRM1554C1HR30WA01#
							±0.1pF	GRM1554C1HR30BA01#
						0.4pF	±0.05pF	GRM1554C1HR40WA01#
							±0.1pF	GRM1554C1HR40BA01#
						0.5pF	±0.05pF	GRM1554C1HR50WA01#
							±0.1pF	GRM1554C1HR50BA01#
						0.6pF	±0.05pF	GRM1554C1HR60WA01#
							±0.1pF	GRM1554C1HR60BA01#
						0.7pF	±0.05pF	GRM1554C1HR70WA01#
							±0.1pF	GRM1554C1HR70BA01#
						0.8pF	±0.05pF	GRM1554C1HR80WA01#
							±0.1pF	GRM1554C1HR80BA01#
0.9pF	±0.05pF	GRM1554C1HR90WA01#						
	±0.1pF	GRM1554C1HR90BA01#						
1.0pF	±0.05pF	GRM1554C1H1R0WA01#						
	±0.1pF	GRM1554C1H1R0BA01#						
1.1pF	±0.05pF	GRM1554C1H1R1WA01#						
	±0.1pF	GRM1554C1H1R1BA01#						

Part number # indicates the package specification code.

For General Purpose GRM Series

Capacitor Array GNM Series

Low ESL LLI Series

High-Q Type GJM Series

High Frequency GQM Series

Monolithic Microchip GMA Series

For Bonding GMD Series

Product Information

## GRM Series Temperature Compensating Type Part Number List

(→ ■ 1.0x0.5mm)

T max.	Rated Voltage	TC Code	Cap.	Tol.	Part Number		
0.55mm	50Vdc	CK	1.1pF	±0.25pF	GRM1554C1H1R1CA01#		
				±0.05pF	GRM1554C1H1R2WA01#		
					±0.1pF	GRM1554C1H1R2BA01#	
			±0.25pF	GRM1554C1H1R2CA01#			
				1.3pF	±0.05pF	GRM1554C1H1R3WA01#	
					±0.1pF	GRM1554C1H1R3BA01#	
			±0.25pF		GRM1554C1H1R3CA01#		
			1.4pF	±0.05pF	GRM1554C1H1R4WA01#		
				±0.1pF	GRM1554C1H1R4BA01#		
				±0.25pF	GRM1554C1H1R4CA01#		
			1.5pF	±0.05pF	GRM1554C1H1R5WA01#		
				±0.1pF	GRM1554C1H1R5BA01#		
				±0.25pF	GRM1554C1H1R5CA01#		
			1.6pF	±0.05pF	GRM1554C1H1R6WA01#		
				±0.1pF	GRM1554C1H1R6BA01#		
				±0.25pF	GRM1554C1H1R6CA01#		
			1.7pF	±0.05pF	GRM1554C1H1R7WA01#		
				±0.1pF	GRM1554C1H1R7BA01#		
				±0.25pF	GRM1554C1H1R7CA01#		
			1.8pF	±0.05pF	GRM1554C1H1R8WA01#		
				±0.1pF	GRM1554C1H1R8BA01#		
				±0.25pF	GRM1554C1H1R8CA01#		
			1.9pF	±0.05pF	GRM1554C1H1R9WA01#		
				±0.1pF	GRM1554C1H1R9BA01#		
				±0.25pF	GRM1554C1H1R9CA01#		
			2.0pF	±0.05pF	GRM1554C1H2R0WA01#		
				±0.1pF	GRM1554C1H2R0BA01#		
				±0.25pF	GRM1554C1H2R0CA01#		
			CJ	50Vdc	2.1pF	±0.05pF	GRM1553C1H2R1WA01#
						±0.1pF	GRM1553C1H2R1BA01#
						±0.25pF	GRM1553C1H2R1CA01#
					2.2pF	±0.05pF	GRM1553C1H2R2WA01#
						±0.1pF	GRM1553C1H2R2BA01#
						±0.25pF	GRM1553C1H2R2CA01#
					2.3pF	±0.05pF	GRM1553C1H2R3WA01#
						±0.1pF	GRM1553C1H2R3BA01#
		±0.25pF				GRM1553C1H2R3CA01#	
		2.4pF			±0.05pF	GRM1553C1H2R4WA01#	
					±0.1pF	GRM1553C1H2R4BA01#	
					±0.25pF	GRM1553C1H2R4CA01#	
		2.5pF			±0.05pF	GRM1553C1H2R5WA01#	
					±0.1pF	GRM1553C1H2R5BA01#	
					±0.25pF	GRM1553C1H2R5CA01#	
		2.6pF			±0.05pF	GRM1553C1H2R6WA01#	
					±0.1pF	GRM1553C1H2R6BA01#	
					±0.25pF	GRM1553C1H2R6CA01#	
		2.7pF			±0.05pF	GRM1553C1H2R7WA01#	
					±0.1pF	GRM1553C1H2R7BA01#	
					±0.25pF	GRM1553C1H2R7CA01#	
		2.8pF			±0.05pF	GRM1553C1H2R8WA01#	
					±0.1pF	GRM1553C1H2R8BA01#	
					±0.25pF	GRM1553C1H2R8CA01#	
		2.9pF			±0.05pF	GRM1553C1H2R9WA01#	
					±0.1pF	GRM1553C1H2R9BA01#	

T max.	Rated Voltage	TC Code	Cap.	Tol.	Part Number		
0.55mm	50Vdc	CJ	2.9pF	±0.25pF	GRM1553C1H2R9CA01#		
				±0.05pF	GRM1553C1H3R0WA01#		
					±0.1pF	GRM1553C1H3R0BA01#	
			±0.25pF	GRM1553C1H3R0CA01#			
				3.1pF	±0.05pF	GRM1553C1H3R1WA01#	
					±0.1pF	GRM1553C1H3R1BA01#	
			±0.25pF		GRM1553C1H3R1CA01#		
			3.2pF	±0.05pF	GRM1553C1H3R2WA01#		
				±0.1pF	GRM1553C1H3R2BA01#		
				±0.25pF	GRM1553C1H3R2CA01#		
			3.3pF	±0.05pF	GRM1553C1H3R3WA01#		
				±0.1pF	GRM1553C1H3R3BA01#		
				±0.25pF	GRM1553C1H3R3CA01#		
			3.4pF	±0.05pF	GRM1553C1H3R4WA01#		
				±0.1pF	GRM1553C1H3R4BA01#		
				±0.25pF	GRM1553C1H3R4CA01#		
			3.5pF	±0.05pF	GRM1553C1H3R5WA01#		
				±0.1pF	GRM1553C1H3R5BA01#		
				±0.25pF	GRM1553C1H3R5CA01#		
			3.6pF	±0.05pF	GRM1553C1H3R6WA01#		
				±0.1pF	GRM1553C1H3R6BA01#		
				±0.25pF	GRM1553C1H3R6CA01#		
			3.7pF	±0.05pF	GRM1553C1H3R7WA01#		
				±0.1pF	GRM1553C1H3R7BA01#		
				±0.25pF	GRM1553C1H3R7CA01#		
			3.8pF	±0.05pF	GRM1553C1H3R8WA01#		
				±0.1pF	GRM1553C1H3R8BA01#		
				±0.25pF	GRM1553C1H3R8CA01#		
			3.9pF	±0.05pF	GRM1553C1H3R9WA01#		
				±0.1pF	GRM1553C1H3R9BA01#		
				±0.25pF	GRM1553C1H3R9CA01#		
			CH	50Vdc	4.0pF	±0.05pF	GRM1552C1H4R0WA01#
						±0.1pF	GRM1552C1H4R0BA01#
						±0.25pF	GRM1552C1H4R0CA01#
					4.1pF	±0.05pF	GRM1552C1H4R1WA01#
						±0.1pF	GRM1552C1H4R1BA01#
		±0.25pF				GRM1552C1H4R1CA01#	
		4.2pF			±0.05pF	GRM1552C1H4R2WA01#	
					±0.1pF	GRM1552C1H4R2BA01#	
					±0.25pF	GRM1552C1H4R2CA01#	
		4.3pF			±0.05pF	GRM1552C1H4R3WA01#	
					±0.1pF	GRM1552C1H4R3BA01#	
					±0.25pF	GRM1552C1H4R3CA01#	
		4.4pF			±0.05pF	GRM1552C1H4R4WA01#	
					±0.1pF	GRM1552C1H4R4BA01#	
					±0.25pF	GRM1552C1H4R4CA01#	
		4.5pF			±0.05pF	GRM1552C1H4R5WA01#	
					±0.1pF	GRM1552C1H4R5BA01#	
					±0.25pF	GRM1552C1H4R5CA01#	
		4.6pF			±0.05pF	GRM1552C1H4R6WA01#	
					±0.1pF	GRM1552C1H4R6BA01#	
					±0.25pF	GRM1552C1H4R6CA01#	
		4.7pF			±0.05pF	GRM1552C1H4R7WA01#	
					±0.1pF	GRM1552C1H4R7BA01#	

Part number # indicates the package specification code.



## GRM Series Temperature Compensating Type Part Number List

(→ ■ 1.0x0.5mm)

T max.	Rated Voltage	TC Code	Cap.	Tol.	Part Number	
0.55mm	50Vdc	CH	4.7pF	±0.25pF	GRM1552C1H4R7CA01#	
				±0.05pF	GRM1552C1H4R8WA01#	
					±0.1pF	GRM1552C1H4R8BA01#
					±0.25pF	GRM1552C1H4R8CA01#
			4.9pF	±0.05pF	GRM1552C1H4R9WA01#	
				±0.1pF	GRM1552C1H4R9BA01#	
				±0.25pF	GRM1552C1H4R9CA01#	
			5.0pF	±0.05pF	GRM1552C1H5R0WA01#	
				±0.1pF	GRM1552C1H5R0BA01#	
				±0.25pF	GRM1552C1H5R0CA01#	
			5.1pF	±0.05pF	GRM1552C1H5R1WA01#	
				±0.1pF	GRM1552C1H5R1BA01#	
				±0.25pF	GRM1552C1H5R1CA01#	
				±0.5pF	GRM1552C1H5R1DA01#	
			5.2pF	±0.05pF	GRM1552C1H5R2WA01#	
				±0.1pF	GRM1552C1H5R2BA01#	
				±0.25pF	GRM1552C1H5R2CA01#	
				±0.5pF	GRM1552C1H5R2DA01#	
			5.3pF	±0.05pF	GRM1552C1H5R3WA01#	
				±0.1pF	GRM1552C1H5R3BA01#	
				±0.25pF	GRM1552C1H5R3CA01#	
				±0.5pF	GRM1552C1H5R3DA01#	
			5.4pF	±0.05pF	GRM1552C1H5R4WA01#	
				±0.1pF	GRM1552C1H5R4BA01#	
				±0.25pF	GRM1552C1H5R4CA01#	
				±0.5pF	GRM1552C1H5R4DA01#	
			5.5pF	±0.05pF	GRM1552C1H5R5WA01#	
				±0.1pF	GRM1552C1H5R5BA01#	
				±0.25pF	GRM1552C1H5R5CA01#	
				±0.5pF	GRM1552C1H5R5DA01#	
			5.6pF	±0.05pF	GRM1552C1H5R6WA01#	
				±0.1pF	GRM1552C1H5R6BA01#	
				±0.25pF	GRM1552C1H5R6CA01#	
				±0.5pF	GRM1552C1H5R6DA01#	
			5.7pF	±0.05pF	GRM1552C1H5R7WA01#	
				±0.1pF	GRM1552C1H5R7BA01#	
				±0.25pF	GRM1552C1H5R7CA01#	
				±0.5pF	GRM1552C1H5R7DA01#	
			5.8pF	±0.05pF	GRM1552C1H5R8WA01#	
				±0.1pF	GRM1552C1H5R8BA01#	
				±0.25pF	GRM1552C1H5R8CA01#	
				±0.5pF	GRM1552C1H5R8DA01#	
			5.9pF	±0.05pF	GRM1552C1H5R9WA01#	
				±0.1pF	GRM1552C1H5R9BA01#	
				±0.25pF	GRM1552C1H5R9CA01#	
				±0.5pF	GRM1552C1H5R9DA01#	
			6.0pF	±0.05pF	GRM1552C1H6R0WA01#	
				±0.1pF	GRM1552C1H6R0BA01#	
				±0.25pF	GRM1552C1H6R0CA01#	
				±0.5pF	GRM1552C1H6R0DA01#	
			6.1pF	±0.05pF	GRM1552C1H6R1WA01#	
				±0.1pF	GRM1552C1H6R1BA01#	
				±0.25pF	GRM1552C1H6R1CA01#	
				±0.5pF	GRM1552C1H6R1DA01#	

T max.	Rated Voltage	TC Code	Cap.	Tol.	Part Number
0.55mm	50Vdc	CH	6.2pF	±0.05pF	GRM1552C1H6R2WA01#
				±0.1pF	GRM1552C1H6R2BA01#
				±0.25pF	GRM1552C1H6R2CA01#
				±0.5pF	GRM1552C1H6R2DA01#
			6.3pF	±0.05pF	GRM1552C1H6R3WA01#
				±0.1pF	GRM1552C1H6R3BA01#
				±0.25pF	GRM1552C1H6R3CA01#
				±0.5pF	GRM1552C1H6R3DA01#
			6.4pF	±0.05pF	GRM1552C1H6R4WA01#
				±0.1pF	GRM1552C1H6R4BA01#
				±0.25pF	GRM1552C1H6R4CA01#
			6.5pF	±0.05pF	GRM1552C1H6R5WA01#
				±0.1pF	GRM1552C1H6R5BA01#
				±0.25pF	GRM1552C1H6R5CA01#
				±0.5pF	GRM1552C1H6R5DA01#
			6.6pF	±0.05pF	GRM1552C1H6R6WA01#
				±0.1pF	GRM1552C1H6R6BA01#
				±0.25pF	GRM1552C1H6R6CA01#
				±0.5pF	GRM1552C1H6R6DA01#
			6.7pF	±0.05pF	GRM1552C1H6R7WA01#
				±0.1pF	GRM1552C1H6R7BA01#
				±0.25pF	GRM1552C1H6R7CA01#
				±0.5pF	GRM1552C1H6R7DA01#
			6.8pF	±0.05pF	GRM1552C1H6R8WA01#
				±0.1pF	GRM1552C1H6R8BA01#
				±0.25pF	GRM1552C1H6R8CA01#
				±0.5pF	GRM1552C1H6R8DA01#
			6.9pF	±0.05pF	GRM1552C1H6R9WA01#
				±0.1pF	GRM1552C1H6R9BA01#
				±0.25pF	GRM1552C1H6R9CA01#
				±0.5pF	GRM1552C1H6R9DA01#
			7.0pF	±0.05pF	GRM1552C1H7R0WA01#
				±0.1pF	GRM1552C1H7R0BA01#
				±0.25pF	GRM1552C1H7R0CA01#
				±0.5pF	GRM1552C1H7R0DA01#
			7.1pF	±0.05pF	GRM1552C1H7R1WA01#
				±0.1pF	GRM1552C1H7R1BA01#
				±0.25pF	GRM1552C1H7R1CA01#
				±0.5pF	GRM1552C1H7R1DA01#
			7.2pF	±0.05pF	GRM1552C1H7R2WA01#
				±0.1pF	GRM1552C1H7R2BA01#
				±0.25pF	GRM1552C1H7R2CA01#
				±0.5pF	GRM1552C1H7R2DA01#
			7.3pF	±0.05pF	GRM1552C1H7R3WA01#
				±0.1pF	GRM1552C1H7R3BA01#
				±0.25pF	GRM1552C1H7R3CA01#
				±0.5pF	GRM1552C1H7R3DA01#
			7.4pF	±0.05pF	GRM1552C1H7R4WA01#
				±0.1pF	GRM1552C1H7R4BA01#
				±0.25pF	GRM1552C1H7R4CA01#
				±0.5pF	GRM1552C1H7R4DA01#
			7.5pF	±0.05pF	GRM1552C1H7R5WA01#
				±0.1pF	GRM1552C1H7R5BA01#

Part number # indicates the package specification code.

For General Purpose GRM Series  
 Capacitor Array GNM Series  
 Low ESL LLI Series  
 High-Q Type GJM Series  
 High Frequency GQM Series  
 Monolithic Microchip GMA Series  
 For Bonding GMD Series  
 Product Information

## GRM Series Temperature Compensating Type Part Number List

(→ ■ 1.0x0.5mm)

T max.	Rated Voltage	TC Code	Cap.	Tol.	Part Number
0.55mm	50Vdc	CH	7.5pF	±0.25pF	GRM1552C1H7R5CA01#
				±0.5pF	GRM1552C1H7R5DA01#
			7.6pF	±0.05pF	GRM1552C1H7R6WA01#
				±0.1pF	GRM1552C1H7R6BA01#
				±0.25pF	GRM1552C1H7R6CA01#
				±0.5pF	GRM1552C1H7R6DA01#
			7.7pF	±0.05pF	GRM1552C1H7R7WA01#
				±0.1pF	GRM1552C1H7R7BA01#
				±0.25pF	GRM1552C1H7R7CA01#
				±0.5pF	GRM1552C1H7R7DA01#
			7.8pF	±0.05pF	GRM1552C1H7R8WA01#
				±0.1pF	GRM1552C1H7R8BA01#
				±0.25pF	GRM1552C1H7R8CA01#
				±0.5pF	GRM1552C1H7R8DA01#
			7.9pF	±0.05pF	GRM1552C1H7R9WA01#
				±0.1pF	GRM1552C1H7R9BA01#
				±0.25pF	GRM1552C1H7R9CA01#
				±0.5pF	GRM1552C1H7R9DA01#
			8.0pF	±0.05pF	GRM1552C1H8R0WA01#
				±0.1pF	GRM1552C1H8R0BA01#
				±0.25pF	GRM1552C1H8R0CA01#
				±0.5pF	GRM1552C1H8R0DA01#
			8.1pF	±0.05pF	GRM1552C1H8R1WA01#
				±0.1pF	GRM1552C1H8R1BA01#
				±0.25pF	GRM1552C1H8R1CA01#
				±0.5pF	GRM1552C1H8R1DA01#
			8.2pF	±0.05pF	GRM1552C1H8R2WA01#
				±0.1pF	GRM1552C1H8R2BA01#
				±0.25pF	GRM1552C1H8R2CA01#
				±0.5pF	GRM1552C1H8R2DA01#
			8.3pF	±0.05pF	GRM1552C1H8R3WA01#
				±0.1pF	GRM1552C1H8R3BA01#
				±0.25pF	GRM1552C1H8R3CA01#
				±0.5pF	GRM1552C1H8R3DA01#
			8.4pF	±0.05pF	GRM1552C1H8R4WA01#
				±0.1pF	GRM1552C1H8R4BA01#
				±0.25pF	GRM1552C1H8R4CA01#
				±0.5pF	GRM1552C1H8R4DA01#
			8.5pF	±0.05pF	GRM1552C1H8R5WA01#
				±0.1pF	GRM1552C1H8R5BA01#
				±0.25pF	GRM1552C1H8R5CA01#
				±0.5pF	GRM1552C1H8R5DA01#
			8.6pF	±0.05pF	GRM1552C1H8R6WA01#
				±0.1pF	GRM1552C1H8R6BA01#
				±0.25pF	GRM1552C1H8R6CA01#
				±0.5pF	GRM1552C1H8R6DA01#
			8.7pF	±0.05pF	GRM1552C1H8R7WA01#
				±0.1pF	GRM1552C1H8R7BA01#
±0.25pF	GRM1552C1H8R7CA01#				
±0.5pF	GRM1552C1H8R7DA01#				
8.8pF	±0.05pF	GRM1552C1H8R8WA01#			
	±0.1pF	GRM1552C1H8R8BA01#			
	±0.25pF	GRM1552C1H8R8CA01#			
	±0.5pF	GRM1552C1H8R8DA01#			

T max.	Rated Voltage	TC Code	Cap.	Tol.	Part Number
0.55mm	50Vdc	CH	8.9pF	±0.05pF	GRM1552C1H8R9WA01#
				±0.1pF	GRM1552C1H8R9BA01#
				±0.25pF	GRM1552C1H8R9CA01#
				±0.5pF	GRM1552C1H8R9DA01#
			9.0pF	±0.05pF	GRM1552C1H9R0WA01#
				±0.1pF	GRM1552C1H9R0BA01#
				±0.25pF	GRM1552C1H9R0CA01#
				±0.5pF	GRM1552C1H9R0DA01#
			9.1pF	±0.05pF	GRM1552C1H9R1WA01#
				±0.1pF	GRM1552C1H9R1BA01#
				±0.25pF	GRM1552C1H9R1CA01#
				±0.5pF	GRM1552C1H9R1DA01#
			9.2pF	±0.05pF	GRM1552C1H9R2WA01#
				±0.1pF	GRM1552C1H9R2BA01#
				±0.25pF	GRM1552C1H9R2CA01#
				±0.5pF	GRM1552C1H9R2DA01#
			9.3pF	±0.05pF	GRM1552C1H9R3WA01#
				±0.1pF	GRM1552C1H9R3BA01#
				±0.25pF	GRM1552C1H9R3CA01#
				±0.5pF	GRM1552C1H9R3DA01#
			9.4pF	±0.05pF	GRM1552C1H9R4WA01#
				±0.1pF	GRM1552C1H9R4BA01#
				±0.25pF	GRM1552C1H9R4CA01#
				±0.5pF	GRM1552C1H9R4DA01#
			9.5pF	±0.05pF	GRM1552C1H9R5WA01#
				±0.1pF	GRM1552C1H9R5BA01#
				±0.25pF	GRM1552C1H9R5CA01#
				±0.5pF	GRM1552C1H9R5DA01#
			9.6pF	±0.05pF	GRM1552C1H9R6WA01#
				±0.1pF	GRM1552C1H9R6BA01#
				±0.25pF	GRM1552C1H9R6CA01#
				±0.5pF	GRM1552C1H9R6DA01#
			9.7pF	±0.05pF	GRM1552C1H9R7WA01#
				±0.1pF	GRM1552C1H9R7BA01#
				±0.25pF	GRM1552C1H9R7CA01#
				±0.5pF	GRM1552C1H9R7DA01#
			9.8pF	±0.05pF	GRM1552C1H9R8WA01#
				±0.1pF	GRM1552C1H9R8BA01#
				±0.25pF	GRM1552C1H9R8CA01#
				±0.5pF	GRM1552C1H9R8DA01#
			9.9pF	±0.05pF	GRM1552C1H9R9WA01#
				±0.1pF	GRM1552C1H9R9BA01#
				±0.25pF	GRM1552C1H9R9CA01#
				±0.5pF	GRM1552C1H9R9DA01#
			10pF	±2%	GRM1552C1H100GA01#
				±5%	GRM1552C1H100JA01#
			12pF	±2%	GRM1552C1H120GA01#
				±5%	GRM1552C1H120JA01#
15pF	±2%	GRM1552C1H150GA01#			
	±5%	GRM1552C1H150JA01#			
18pF	±2%	GRM1552C1H180GA01#			
	±5%	GRM1552C1H180JA01#			
22pF	±2%	GRM1552C1H220GA01#			
	±5%	GRM1552C1H220JA01#			

Part number # indicates the package specification code.

## GRM Series Temperature Compensating Type Part Number List

(→ ■ 1.0x0.5mm)

T max.	Rated Voltage	TC Code	Cap.	Tol.	Part Number			
0.55mm	50Vdc	CH	27pF	±2%	GRM1552C1H270GA01#			
				±5%	GRM1552C1H270JA01#			
			33pF	±2%	GRM1552C1H330GA01#			
				±5%	GRM1552C1H330JA01#			
			39pF	±2%	GRM1552C1H390GA01#			
				±5%	GRM1552C1H390JA01#			
			47pF	±2%	GRM1552C1H470GA01#			
				±5%	GRM1552C1H470JA01#			
			56pF	±2%	GRM1552C1H560GA01#			
				±5%	GRM1552C1H560JA01#			
			68pF	±2%	GRM1552C1H680GA01#			
				±5%	GRM1552C1H680JA01#			
			82pF	±2%	GRM1552C1H820GA01#			
				±5%	GRM1552C1H820JA01#			
			100pF	±2%	GRM1552C1H101GA01#			
				±5%	GRM1552C1H101JA01#			
			120pF	±2%	GRM1552C1H121GA01#			
				±5%	GRM1552C1H121JA01#			
			150pF	±2%	GRM1552C1H151GA01#			
				±5%	GRM1552C1H151JA01#			
			180pF	±2%	GRM1552C1H181GA01#			
				±5%	GRM1552C1H181JA01#			
			220pF	±2%	GRM1552C1H221GA01#			
				±5%	GRM1552C1H221JA01#			
			270pF	±2%	GRM1552C1H271GA01#			
				±5%	GRM1552C1H271JA01#			
			330pF	±2%	GRM1552C1H331GA01#			
				±5%	GRM1552C1H331JA01#			
			390pF	±2%	GRM1552C1H391GA01#			
				±5%	GRM1552C1H391JA01#			
			470pF	±2%	GRM1552C1H471GA01#			
				±5%	GRM1552C1H471JA01#			
			560pF	±2%	GRM1552C1H561GA01#			
				±5%	GRM1552C1H561JA01#			
			680pF	±2%	GRM1552C1H681GA01#			
				±5%	GRM1552C1H681JA01#			
			820pF	±2%	GRM1552C1H821GA01#			
				±5%	GRM1552C1H821JA01#			
			1000pF	±2%	GRM1552C1H102GA01#			
				±5%	GRM1552C1H102JA01#			
			P2H	50Vdc	CH	1.0pF	±0.25pF	GRM1556P1H1R0CZ01#
							±0.25pF	GRM1556P1H2R0CZ01#
						3.0pF	±0.25pF	GRM1556P1H3R0CZ01#
							±0.25pF	GRM1556P1H4R0CZ01#
						5.0pF	±0.25pF	GRM1556P1H5R0CZ01#
							±0.5pF	GRM1556P1H6R0DZ01#
						7.0pF	±0.5pF	GRM1556P1H7R0DZ01#
							±0.5pF	GRM1556P1H8R0DZ01#
		9.0pF				±0.5pF	GRM1556P1H9R0DZ01#	
						±5%	GRM1556P1H100JZ01#	
		12pF				±5%	GRM1556P1H120JZ01#	
						±5%	GRM1556P1H150JZ01#	
18pF	±5%	GRM1556P1H180JZ01#						
	±5%	GRM1556P1H220JZ01#						

T max.	Rated Voltage	TC Code	Cap.	Tol.	Part Number		
0.55mm	50Vdc	P2H	27pF	±5%	GRM1556P1H270JZ01#		
				PK	1.0pF ±0.25pF	GRM1554P1H1R0CZ01#	
		PK	2.0pF	±0.25pF	GRM1554P1H2R0CZ01#		
				PJ	3.0pF ±0.25pF	GRM1553P1H3R0CZ01#	
		PH	4.0pF	±0.25pF	GRM1552P1H4R0CZ01#		
				5.0pF ±0.25pF	GRM1552P1H5R0CZ01#		
				6.0pF ±0.5pF	GRM1552P1H6R0DZ01#		
				7.0pF ±0.5pF	GRM1552P1H7R0DZ01#		
				8.0pF ±0.5pF	GRM1552P1H8R0DZ01#		
				9.0pF ±0.5pF	GRM1552P1H9R0DZ01#		
				10pF ±5%	GRM1552P1H100JZ01#		
				12pF ±5%	GRM1552P1H120JZ01#		
				15pF ±5%	GRM1552P1H150JZ01#		
				18pF ±5%	GRM1552P1H180JZ01#		
				22pF ±5%	GRM1552P1H220JZ01#		
				27pF ±5%	GRM1552P1H270JZ01#		
				R2H	1.0pF	±0.25pF	GRM1556R1H1R0CD01#
						2.0pF ±0.25pF	GRM1556R1H2R0CZ01#
		3.0pF ±0.25pF	GRM1556R1H3R0CZ01#				
		4.0pF ±0.25pF	GRM1556R1H4R0CZ01#				
		5.0pF ±0.25pF	GRM1556R1H5R0CZ01#				
		6.0pF ±0.5pF	GRM1556R1H6R0DZ01#				
		7.0pF ±0.5pF	GRM1556R1H7R0DZ01#				
		8.0pF ±0.5pF	GRM1556R1H8R0DZ01#				
		9.0pF ±0.5pF	GRM1556R1H9R0DZ01#				
		10pF ±5%	GRM1556R1H100JZ01#				
		12pF ±5%	GRM1556R1H120JZ01#				
		15pF ±5%	GRM1556R1H150JZ01#				
		18pF ±5%	GRM1556R1H180JZ01#				
		22pF ±5%	GRM1556R1H220JZ01#				
		RK	1.0pF	±0.25pF	GRM1554R1H1R0CD01#		
				2.0pF ±0.25pF	GRM1554R1H2R0CZ01#		
		RJ	3.0pF	±0.25pF	GRM1553R1H3R0CZ01#		
				RH	4.0pF	±0.25pF	GRM1552R1H4R0CZ01#
		5.0pF ±0.25pF	GRM1552R1H5R0CZ01#				
		6.0pF ±0.5pF	GRM1552R1H6R0DZ01#				
		7.0pF ±0.5pF	GRM1552R1H7R0DZ01#				
		8.0pF ±0.5pF	GRM1552R1H8R0DZ01#				
		9.0pF ±0.5pF	GRM1552R1H9R0DZ01#				
		10pF ±5%	GRM1552R1H100JZ01#				
		12pF ±5%	GRM1552R1H120JZ01#				
		15pF ±5%	GRM1552R1H150JZ01#				
		18pF ±5%	GRM1552R1H180JZ01#				
		22pF ±5%	GRM1552R1H220JZ01#				
		27pF ±5%	GRM1552R1H270JZ01#				
		33pF ±5%	GRM1552R1H330JZ01#				
		S2H	1.0pF			±0.25pF	GRM1556S1H1R0CD01#
				2.0pF ±0.25pF	GRM1556S1H2R0CZ01#		
				3.0pF ±0.25pF	GRM1556S1H3R0CZ01#		
				4.0pF ±0.25pF	GRM1556S1H4R0CZ01#		
				5.0pF ±0.25pF	GRM1556S1H5R0CZ01#		
				6.0pF ±0.5pF	GRM1556S1H6R0DZ01#		

Part number # indicates the package specification code.

For General Purpose GRM Series  
 Capacitor Array GNM Series  
 Low ESL LLI Series  
 High-Q Type GJM Series  
 High Frequency GQM Series  
 Monolithic Microchip GMA Series  
 For Bonding GMD Series  
 Product Information

# GRM Series Temperature Compensating Type Part Number List

(→ ■ 1.0x0.5mm)

T max.	Rated Voltage	TC Code	Cap.	Tol.	Part Number	
0.55mm	50Vdc	S2H	7.0pF	±0.5pF	GRM1556S1H7R0DZ01#	
			8.0pF	±0.5pF	GRM1556S1H8R0DZ01#	
			9.0pF	±0.5pF	GRM1556S1H9R0DZ01#	
			10pF	±5%	GRM1556S1H100JZ01#	
			12pF	±5%	GRM1556S1H120JZ01#	
			15pF	±5%	GRM1556S1H150JZ01#	
			18pF	±5%	GRM1556S1H180JZ01#	
			22pF	±5%	GRM1556S1H220JZ01#	
			27pF	±5%	GRM1556S1H270JZ01#	
			33pF	±5%	GRM1556S1H330JZ01#	
		39pF	±5%	GRM1556S1H390JZ01#		
		SK	1.0pF	±0.25pF	GRM1554S1H1R0CD01#	
			2.0pF	±0.25pF	GRM1554S1H2R0CZ01#	
		SJ	3.0pF	±0.25pF	GRM1553S1H3R0CZ01#	
		SH	4.0pF	±0.25pF	GRM1552S1H4R0CZ01#	
			5.0pF	±0.25pF	GRM1552S1H5R0CZ01#	
			6.0pF	±0.5pF	GRM1552S1H6R0DZ01#	
			7.0pF	±0.5pF	GRM1552S1H7R0DZ01#	
			8.0pF	±0.5pF	GRM1552S1H8R0DZ01#	
			9.0pF	±0.5pF	GRM1552S1H9R0DZ01#	
			10pF	±5%	GRM1552S1H100JZ01#	
			12pF	±5%	GRM1552S1H120JZ01#	
			15pF	±5%	GRM1552S1H150JZ01#	
			18pF	±5%	GRM1552S1H180JZ01#	
		T2H	22pF	±5%	GRM1552S1H220JZ01#	
			27pF	±5%	GRM1552S1H270JZ01#	
			33pF	±5%	GRM1552S1H330JZ01#	
			39pF	±5%	GRM1552S1H390JZ01#	
			1.0pF	±0.25pF	GRM1556T1H1R0CD01#	
			2.0pF	±0.25pF	GRM1556T1H2R0CD01#	
			3.0pF	±0.25pF	GRM1556T1H3R0CD01#	
			4.0pF	±0.25pF	GRM1556T1H4R0CD01#	
			5.0pF	±0.25pF	GRM1556T1H5R0CD01#	
			6.0pF	±0.5pF	GRM1556T1H6R0DD01#	
		TK	7.0pF	±0.5pF	GRM1556T1H7R0DD01#	
			8.0pF	±0.5pF	GRM1556T1H8R0DD01#	
			9.0pF	±0.5pF	GRM1556T1H9R0DD01#	
			10pF	±5%	GRM1556T1H100JD01#	
			12pF	±5%	GRM1556T1H120JD01#	
			15pF	±5%	GRM1556T1H150JD01#	
			18pF	±5%	GRM1556T1H180JD01#	
			22pF	±5%	GRM1556T1H220JD01#	
			27pF	±5%	GRM1556T1H270JD01#	
			33pF	±5%	GRM1556T1H330JD01#	
		TJ	39pF	±5%	GRM1556T1H390JD01#	
			47pF	±5%	GRM1556T1H470JD01#	
			56pF	±5%	GRM1556T1H560JD01#	
			68pF	±5%	GRM1556T1H680JD01#	
			82pF	±5%	GRM1556T1H820JD01#	
			100pF	±5%	GRM1556T1H101JD01#	
			TH	1.0pF	±0.25pF	GRM1554T1H1R0CD01#
				2.0pF	±0.25pF	GRM1554T1H2R0CD01#

T max.	Rated Voltage	TC Code	Cap.	Tol.	Part Number	
0.55mm	50Vdc	TH	5.0pF	±0.25pF	GRM1552T1H5R0CD01#	
			6.0pF	±0.5pF	GRM1552T1H6R0DD01#	
			7.0pF	±0.5pF	GRM1552T1H7R0DD01#	
			8.0pF	±0.5pF	GRM1552T1H8R0DD01#	
			9.0pF	±0.5pF	GRM1552T1H9R0DD01#	
			10pF	±5%	GRM1552T1H100JD01#	
			12pF	±5%	GRM1552T1H120JD01#	
			15pF	±5%	GRM1552T1H150JD01#	
			18pF	±5%	GRM1552T1H180JD01#	
			22pF	±5%	GRM1552T1H220JD01#	
		UK	27pF	±5%	GRM1552T1H270JD01#	
			33pF	±5%	GRM1552T1H330JD01#	
			39pF	±5%	GRM1552T1H390JD01#	
			47pF	±5%	GRM1552T1H470JD01#	
			56pF	±5%	GRM1552T1H560JD01#	
			68pF	±5%	GRM1552T1H680JD01#	
			82pF	±5%	GRM1552T1H820JD01#	
			100pF	±5%	GRM1552T1H101JD01#	
			UU	1.0pF	±0.25pF	GRM1554U1H1R0CZ01#
				2.0pF	±0.25pF	GRM1554U1H2R0CZ01#
		3.0pF		±0.25pF	GRM1553U1H3R0CZ01#	
		4.0pF		±0.25pF	GRM1553U1H4R0CZ01#	
		5.0pF		±0.25pF	GRM1553U1H5R0CZ01#	
		6.0pF		±0.5pF	GRM1553U1H6R0DZ01#	
		7.0pF		±0.5pF	GRM1553U1H7R0DZ01#	
		8.0pF		±0.5pF	GRM1553U1H8R0DZ01#	
		9.0pF		±0.5pF	GRM1553U1H9R0DZ01#	
		10pF		±5%	GRM1553U1H100JZ01#	
		SL	12pF	±5%	GRM1553U1H120JZ01#	
			15pF	±5%	GRM1553U1H150JZ01#	
			18pF	±5%	GRM1553U1H180JZ01#	
			22pF	±5%	GRM1553U1H220JZ01#	
			27pF	±5%	GRM1553U1H270JZ01#	
			33pF	±5%	GRM1553U1H330JZ01#	
			39pF	±5%	GRM1553U1H390JZ01#	
			47pF	±5%	GRM1553U1H470JZ01#	
			56pF	±5%	GRM1553U1H560JZ01#	
			68pF	±5%	GRM1553U1H680JZ01#	
		U2J	82pF	±5%	GRM1553U1H820JZ01#	
			100pF	±5%	GRM1553U1H101JZ01#	
			120pF	±5%	GRM1553U1H121JZ01#	
			150pF	±5%	GRM1553U1H151JZ01#	
			180pF	±5%	GRM1553U1H181JZ01#	
			1200pF	±5%	GRM1551X1A122JA01#	
			1500pF	±5%	GRM1551X1A152JA01#	
			1800pF	±5%	GRM1551X1A182JA01#	
			2200pF	±5%	GRM1551X1A222JA01#	
			2700pF	±5%	GRM1551X1A272JA01#	
		SL	3300pF	±5%	GRM1551X1A332JA01#	
			3900pF	±5%	GRM1551X1A392JA01#	
			4700pF	±5%	GRM1551X1A472JA01#	
			1200pF	±5%	GRM1557U1A122JA01#	
			1500pF	±5%	GRM1557U1A152JA01#	
			1800pF	±5%	GRM1557U1A182JA01#	

For General Purpose GRM Series  
 Capacitor Array GNM Series  
 Low ESL LL Series  
 High-Q Type GJM Series  
 High Frequency GQM Series  
 Monolithic Microchip GMA Series  
 For Bonding GMD Series  
 Product Information

Part number # indicates the package specification code.



## GRM Series Temperature Compensating Type Part Number List

(→ ■ 1.0x0.5mm)

T max.	Rated Voltage	TC Code	Cap.	Tol.	Part Number
0.55mm	10Vdc	U2J	2200pF	±5%	GRM1557U1A222JA01#
			2700pF	±5%	GRM1557U1A272JA01#
			3300pF	±5%	GRM1557U1A332JA01#
			3900pF	±5%	GRM1557U1A392JA01#
			4700pF	±5%	GRM1557U1A472JA01#
		UJ	1200pF	±5%	GRM1553U1A122JA01#
			1500pF	±5%	GRM1553U1A152JA01#
			1800pF	±5%	GRM1553U1A182JA01#
			2200pF	±5%	GRM1553U1A222JA01#
			2700pF	±5%	GRM1553U1A272JA01#
			3300pF	±5%	GRM1553U1A332JA01#
			3900pF	±5%	GRM1553U1A392JA01#
			4700pF	±5%	GRM1553U1A472JA01#

■ 1.6x0.8mm

T max.	Rated Voltage	TC Code	Cap.	Tol.	Part Number				
0.5mm	50Vdc	SL	2200pF	±5%	GRM1851X1H222JA44#				
			2700pF	±5%	GRM1851X1H272JA44#				
			3300pF	±5%	GRM1851X1H332JA44#				
			3900pF	±5%	GRM1851X1H392JA44#				
			4700pF	±5%	GRM1851X1H472JA44#				
		U2J	2200pF	±5%	GRM1857U1H222JA44#				
			2700pF	±5%	GRM1857U1H272JA44#				
			3300pF	±5%	GRM1857U1H332JA44#				
			3900pF	±5%	GRM1857U1H392JA44#				
			4700pF	±5%	GRM1857U1H472JA44#				
			UJ	2200pF	±5%	GRM1853U1H222JA44#			
				2700pF	±5%	GRM1853U1H272JA44#			
				3300pF	±5%	GRM1853U1H332JA44#			
				3900pF	±5%	GRM1853U1H392JA44#			
				4700pF	±5%	GRM1853U1H472JA44#			
		10Vdc	SL	5600pF	±5%	GRM1851X1A562JA44#			
				6800pF	±5%	GRM1851X1A682JA44#			
				8200pF	±5%	GRM1851X1A822JA44#			
				10000pF	±5%	GRM1851X1A103JA44#			
			U2J	5600pF	±5%	GRM1857U1A562JA44#			
				6800pF	±5%	GRM1857U1A682JA44#			
				8200pF	±5%	GRM1857U1A822JA44#			
				10000pF	±5%	GRM1857U1A103JA44#			
				UJ	5600pF	±5%	GRM1853U1A562JA44#		
			6800pF		±5%	GRM1853U1A682JA44#			
			8200pF		±5%	GRM1853U1A822JA44#			
			10000pF		±5%	GRM1853U1A103JA44#			
			0.9mm		100Vdc	C0G	0.5pF	±0.05pF	GRM1885C2AR50WA01#
								±0.1pF	GRM1885C2AR50BA01#
				0.6pF			±0.05pF	GRM1885C2AR60WA01#	
±0.1pF	GRM1885C2AR60BA01#								
0.7pF	±0.05pF	GRM1885C2AR70WA01#							
	±0.1pF	GRM1885C2AR70BA01#							
0.8pF	±0.05pF	GRM1885C2AR80WA01#							
	±0.1pF	GRM1885C2AR80BA01#							
0.9pF	±0.05pF	GRM1885C2AR90WA01#							

T max.	Rated Voltage	TC Code	Cap.	Tol.	Part Number	
0.9mm	100Vdc	C0G	0.9pF	±0.1pF	GRM1885C2AR90BA01#	
				±0.05pF	GRM1885C2A1R0WA01#	
					GRM1885C2A1R0BA01#	
			±0.25pF	GRM1885C2A1R0CA01#		
				1.1pF	±0.05pF	GRM1885C2A1R1WA01#
					±0.1pF	GRM1885C2A1R1BA01#
			±0.25pF		GRM1885C2A1R1CA01#	
			1.2pF	±0.05pF	GRM1885C2A1R2WA01#	
				±0.1pF	GRM1885C2A1R2BA01#	
				±0.25pF	GRM1885C2A1R2CA01#	
			1.3pF	±0.05pF	GRM1885C2A1R3WA01#	
				±0.1pF	GRM1885C2A1R3BA01#	
				±0.25pF	GRM1885C2A1R3CA01#	
			1.4pF	±0.05pF	GRM1885C2A1R4WA01#	
				±0.1pF	GRM1885C2A1R4BA01#	
				±0.25pF	GRM1885C2A1R4CA01#	
			1.5pF	±0.05pF	GRM1885C2A1R5WA01#	
				±0.1pF	GRM1885C2A1R5BA01#	
				±0.25pF	GRM1885C2A1R5CA01#	
			1.6pF	±0.05pF	GRM1885C2A1R6WA01#	
				±0.1pF	GRM1885C2A1R6BA01#	
				±0.25pF	GRM1885C2A1R6CA01#	
			1.7pF	±0.05pF	GRM1885C2A1R7WA01#	
				±0.1pF	GRM1885C2A1R7BA01#	
				±0.25pF	GRM1885C2A1R7CA01#	
			1.8pF	±0.05pF	GRM1885C2A1R8WA01#	
				±0.1pF	GRM1885C2A1R8BA01#	
				±0.25pF	GRM1885C2A1R8CA01#	
			1.9pF	±0.05pF	GRM1885C2A1R9WA01#	
				±0.1pF	GRM1885C2A1R9BA01#	
				±0.25pF	GRM1885C2A1R9CA01#	
			2.0pF	±0.05pF	GRM1885C2A2R0WA01#	
				±0.1pF	GRM1885C2A2R0BA01#	
				±0.25pF	GRM1885C2A2R0CA01#	
			2.1pF	±0.05pF	GRM1885C2A2R1WA01#	
				±0.1pF	GRM1885C2A2R1BA01#	
				±0.25pF	GRM1885C2A2R1CA01#	
			2.2pF	±0.05pF	GRM1885C2A2R2WA01#	
				±0.1pF	GRM1885C2A2R2BA01#	
				±0.25pF	GRM1885C2A2R2CA01#	
			2.3pF	±0.05pF	GRM1885C2A2R3WA01#	
				±0.1pF	GRM1885C2A2R3BA01#	
±0.25pF	GRM1885C2A2R3CA01#					
2.4pF	±0.05pF	GRM1885C2A2R4WA01#				
	±0.1pF	GRM1885C2A2R4BA01#				
	±0.25pF	GRM1885C2A2R4CA01#				
2.5pF	±0.05pF	GRM1885C2A2R5WA01#				
	±0.1pF	GRM1885C2A2R5BA01#				
	±0.25pF	GRM1885C2A2R5CA01#				
2.6pF	±0.05pF	GRM1885C2A2R6WA01#				
	±0.1pF	GRM1885C2A2R6BA01#				
	±0.25pF	GRM1885C2A2R6CA01#				
2.7pF	±0.05pF	GRM1885C2A2R7WA01#				
	±0.1pF	GRM1885C2A2R7BA01#				

Part number # indicates the package specification code.

For General Purpose GRM Series  
 Capacitor Array GNM Series  
 Low ESL LLI Series  
 High-Q Type GJM Series  
 High Frequency GQM Series  
 Monolithic Microchip GMA Series  
 For Bonding GMD Series  
 Product Information

## GRM Series Temperature Compensating Type Part Number List

(→ ■ 1.6x0.8mm)

T max.	Rated Voltage	TC Code	Cap.	Tol.	Part Number	
0.9mm	100Vdc	C0G	2.7pF	±0.25pF	GRM1885C2A2R7CA01#	
				±0.05pF	GRM1885C2A2R8WA01#	
					±0.1pF	GRM1885C2A2R8BA01#
			±0.25pF	GRM1885C2A2R8CA01#		
				2.9pF	±0.05pF	GRM1885C2A2R9WA01#
					±0.1pF	GRM1885C2A2R9BA01#
			±0.25pF		GRM1885C2A2R9CA01#	
			3.0pF	±0.05pF	GRM1885C2A3R0WA01#	
				±0.1pF	GRM1885C2A3R0BA01#	
				±0.25pF	GRM1885C2A3R0CA01#	
			3.1pF	±0.05pF	GRM1885C2A3R1WA01#	
				±0.1pF	GRM1885C2A3R1BA01#	
				±0.25pF	GRM1885C2A3R1CA01#	
			3.2pF	±0.05pF	GRM1885C2A3R2WA01#	
				±0.1pF	GRM1885C2A3R2BA01#	
				±0.25pF	GRM1885C2A3R2CA01#	
			3.3pF	±0.05pF	GRM1885C2A3R3WA01#	
				±0.1pF	GRM1885C2A3R3BA01#	
				±0.25pF	GRM1885C2A3R3CA01#	
			3.4pF	±0.05pF	GRM1885C2A3R4WA01#	
				±0.1pF	GRM1885C2A3R4BA01#	
				±0.25pF	GRM1885C2A3R4CA01#	
			3.5pF	±0.05pF	GRM1885C2A3R5WA01#	
				±0.1pF	GRM1885C2A3R5BA01#	
				±0.25pF	GRM1885C2A3R5CA01#	
			3.6pF	±0.05pF	GRM1885C2A3R6WA01#	
				±0.1pF	GRM1885C2A3R6BA01#	
				±0.25pF	GRM1885C2A3R6CA01#	
			3.7pF	±0.05pF	GRM1885C2A3R7WA01#	
				±0.1pF	GRM1885C2A3R7BA01#	
				±0.25pF	GRM1885C2A3R7CA01#	
			3.8pF	±0.05pF	GRM1885C2A3R8WA01#	
				±0.1pF	GRM1885C2A3R8BA01#	
				±0.25pF	GRM1885C2A3R8CA01#	
			3.9pF	±0.05pF	GRM1885C2A3R9WA01#	
				±0.1pF	GRM1885C2A3R9BA01#	
				±0.25pF	GRM1885C2A3R9CA01#	
			4.0pF	±0.05pF	GRM1885C2A4R0WA01#	
				±0.1pF	GRM1885C2A4R0BA01#	
				±0.25pF	GRM1885C2A4R0CA01#	
			4.1pF	±0.05pF	GRM1885C2A4R1WA01#	
				±0.1pF	GRM1885C2A4R1BA01#	
				±0.25pF	GRM1885C2A4R1CA01#	
			4.2pF	±0.05pF	GRM1885C2A4R2WA01#	
				±0.1pF	GRM1885C2A4R2BA01#	
				±0.25pF	GRM1885C2A4R2CA01#	
			4.3pF	±0.05pF	GRM1885C2A4R3WA01#	
				±0.1pF	GRM1885C2A4R3BA01#	
				±0.25pF	GRM1885C2A4R3CA01#	
			4.4pF	±0.05pF	GRM1885C2A4R4WA01#	
				±0.1pF	GRM1885C2A4R4BA01#	
				±0.25pF	GRM1885C2A4R4CA01#	
			4.5pF	±0.05pF	GRM1885C2A4R5WA01#	
				±0.1pF	GRM1885C2A4R5BA01#	

T max.	Rated Voltage	TC Code	Cap.	Tol.	Part Number	
0.9mm	100Vdc	C0G	4.5pF	±0.25pF	GRM1885C2A4R5CA01#	
				±0.05pF	GRM1885C2A4R6WA01#	
					±0.1pF	GRM1885C2A4R6BA01#
			±0.25pF	GRM1885C2A4R6CA01#		
				4.7pF	±0.05pF	GRM1885C2A4R7WA01#
					±0.1pF	GRM1885C2A4R7BA01#
			±0.25pF		GRM1885C2A4R7CA01#	
			4.8pF	±0.05pF	GRM1885C2A4R8WA01#	
				±0.1pF	GRM1885C2A4R8BA01#	
				±0.25pF	GRM1885C2A4R8CA01#	
			4.9pF	±0.05pF	GRM1885C2A4R9WA01#	
				±0.1pF	GRM1885C2A4R9BA01#	
				±0.25pF	GRM1885C2A4R9CA01#	
			5.0pF	±0.05pF	GRM1885C2A5R0WA01#	
				±0.1pF	GRM1885C2A5R0BA01#	
				±0.25pF	GRM1885C2A5R0CA01#	
			5.1pF	±0.05pF	GRM1885C2A5R1WA01#	
				±0.1pF	GRM1885C2A5R1BA01#	
				±0.25pF	GRM1885C2A5R1CA01#	
			±0.5pF	GRM1885C2A5R1DA01#		
				5.2pF	±0.05pF	GRM1885C2A5R2WA01#
					±0.1pF	GRM1885C2A5R2BA01#
			±0.25pF		GRM1885C2A5R2CA01#	
			±0.5pF	GRM1885C2A5R2DA01#		
				5.3pF	±0.05pF	GRM1885C2A5R3WA01#
					±0.1pF	GRM1885C2A5R3BA01#
			±0.25pF		GRM1885C2A5R3CA01#	
			±0.5pF	GRM1885C2A5R3DA01#		
				5.4pF	±0.05pF	GRM1885C2A5R4WA01#
					±0.1pF	GRM1885C2A5R4BA01#
			±0.25pF		GRM1885C2A5R4CA01#	
			±0.5pF	GRM1885C2A5R4DA01#		
				5.5pF	±0.05pF	GRM1885C2A5R5WA01#
					±0.1pF	GRM1885C2A5R5BA01#
			±0.25pF		GRM1885C2A5R5CA01#	
			±0.5pF	GRM1885C2A5R5DA01#		
				5.6pF	±0.05pF	GRM1885C2A5R6WA01#
					±0.1pF	GRM1885C2A5R6BA01#
			±0.25pF		GRM1885C2A5R6CA01#	
			±0.5pF	GRM1885C2A5R6DA01#		
				5.7pF	±0.05pF	GRM1885C2A5R7WA01#
					±0.1pF	GRM1885C2A5R7BA01#
			±0.25pF		GRM1885C2A5R7CA01#	
			±0.5pF	GRM1885C2A5R7DA01#		
				5.8pF	±0.05pF	GRM1885C2A5R8WA01#
					±0.1pF	GRM1885C2A5R8BA01#
			±0.25pF		GRM1885C2A5R8CA01#	
			±0.5pF	GRM1885C2A5R8DA01#		
				5.9pF	±0.05pF	GRM1885C2A5R9WA01#
					±0.1pF	GRM1885C2A5R9BA01#
			±0.25pF		GRM1885C2A5R9CA01#	
			±0.5pF	GRM1885C2A5R9DA01#		
				6.0pF	±0.05pF	GRM1885C2A6R0WA01#
					±0.1pF	GRM1885C2A6R0BA01#

Part number # indicates the package specification code.

## GRM Series Temperature Compensating Type Part Number List

(→ ■ 1.6x0.8mm)

T max.	Rated Voltage	TC Code	Cap.	Tol.	Part Number
0.9mm	100Vdc	C0G	6.0pF	±0.25pF	GRM1885C2A6R0CA01#
				±0.5pF	GRM1885C2A6R0DA01#
			6.1pF	±0.05pF	GRM1885C2A6R1WA01#
				±0.1pF	GRM1885C2A6R1BA01#
				±0.25pF	GRM1885C2A6R1CA01#
				±0.5pF	GRM1885C2A6R1DA01#
			6.2pF	±0.05pF	GRM1885C2A6R2WA01#
				±0.1pF	GRM1885C2A6R2BA01#
				±0.25pF	GRM1885C2A6R2CA01#
				±0.5pF	GRM1885C2A6R2DA01#
			6.3pF	±0.05pF	GRM1885C2A6R3WA01#
				±0.1pF	GRM1885C2A6R3BA01#
				±0.25pF	GRM1885C2A6R3CA01#
				±0.5pF	GRM1885C2A6R3DA01#
			6.4pF	±0.05pF	GRM1885C2A6R4WA01#
				±0.1pF	GRM1885C2A6R4BA01#
				±0.25pF	GRM1885C2A6R4CA01#
				±0.5pF	GRM1885C2A6R4DA01#
			6.5pF	±0.05pF	GRM1885C2A6R5WA01#
				±0.1pF	GRM1885C2A6R5BA01#
				±0.25pF	GRM1885C2A6R5CA01#
				±0.5pF	GRM1885C2A6R5DA01#
			6.6pF	±0.05pF	GRM1885C2A6R6WA01#
				±0.1pF	GRM1885C2A6R6BA01#
				±0.25pF	GRM1885C2A6R6CA01#
				±0.5pF	GRM1885C2A6R6DA01#
			6.7pF	±0.05pF	GRM1885C2A6R7WA01#
				±0.1pF	GRM1885C2A6R7BA01#
				±0.25pF	GRM1885C2A6R7CA01#
				±0.5pF	GRM1885C2A6R7DA01#
			6.8pF	±0.05pF	GRM1885C2A6R8WA01#
				±0.1pF	GRM1885C2A6R8BA01#
				±0.25pF	GRM1885C2A6R8CA01#
				±0.5pF	GRM1885C2A6R8DA01#
			6.9pF	±0.05pF	GRM1885C2A6R9WA01#
				±0.1pF	GRM1885C2A6R9BA01#
				±0.25pF	GRM1885C2A6R9CA01#
				±0.5pF	GRM1885C2A6R9DA01#
			7.0pF	±0.05pF	GRM1885C2A7R0WA01#
				±0.1pF	GRM1885C2A7R0BA01#
				±0.25pF	GRM1885C2A7R0CA01#
				±0.5pF	GRM1885C2A7R0DA01#
			7.1pF	±0.05pF	GRM1885C2A7R1WA01#
				±0.1pF	GRM1885C2A7R1BA01#
				±0.25pF	GRM1885C2A7R1CA01#
				±0.5pF	GRM1885C2A7R1DA01#
			7.2pF	±0.05pF	GRM1885C2A7R2WA01#
				±0.1pF	GRM1885C2A7R2BA01#
				±0.25pF	GRM1885C2A7R2CA01#
				±0.5pF	GRM1885C2A7R2DA01#
			7.3pF	±0.05pF	GRM1885C2A7R3WA01#
				±0.1pF	GRM1885C2A7R3BA01#
				±0.25pF	GRM1885C2A7R3CA01#
				±0.5pF	GRM1885C2A7R3DA01#

T max.	Rated Voltage	TC Code	Cap.	Tol.	Part Number
0.9mm	100Vdc	C0G	7.4pF	±0.05pF	GRM1885C2A7R4WA01#
				±0.1pF	GRM1885C2A7R4BA01#
				±0.25pF	GRM1885C2A7R4CA01#
				±0.5pF	GRM1885C2A7R4DA01#
			7.5pF	±0.05pF	GRM1885C2A7R5WA01#
				±0.1pF	GRM1885C2A7R5BA01#
				±0.25pF	GRM1885C2A7R5CA01#
				±0.5pF	GRM1885C2A7R5DA01#
			7.6pF	±0.05pF	GRM1885C2A7R6WA01#
				±0.1pF	GRM1885C2A7R6BA01#
				±0.25pF	GRM1885C2A7R6CA01#
				±0.5pF	GRM1885C2A7R6DA01#
			7.7pF	±0.05pF	GRM1885C2A7R7WA01#
				±0.1pF	GRM1885C2A7R7BA01#
				±0.25pF	GRM1885C2A7R7CA01#
				±0.5pF	GRM1885C2A7R7DA01#
			7.8pF	±0.05pF	GRM1885C2A7R8WA01#
				±0.1pF	GRM1885C2A7R8BA01#
				±0.25pF	GRM1885C2A7R8CA01#
				±0.5pF	GRM1885C2A7R8DA01#
			7.9pF	±0.05pF	GRM1885C2A7R9WA01#
				±0.1pF	GRM1885C2A7R9BA01#
				±0.25pF	GRM1885C2A7R9CA01#
				±0.5pF	GRM1885C2A7R9DA01#
			8.0pF	±0.05pF	GRM1885C2A8R0WA01#
				±0.1pF	GRM1885C2A8R0BA01#
				±0.25pF	GRM1885C2A8R0CA01#
				±0.5pF	GRM1885C2A8R0DA01#
			8.1pF	±0.05pF	GRM1885C2A8R1WA01#
				±0.1pF	GRM1885C2A8R1BA01#
				±0.25pF	GRM1885C2A8R1CA01#
				±0.5pF	GRM1885C2A8R1DA01#
			8.2pF	±0.05pF	GRM1885C2A8R2WA01#
				±0.1pF	GRM1885C2A8R2BA01#
				±0.25pF	GRM1885C2A8R2CA01#
				±0.5pF	GRM1885C2A8R2DA01#
			8.3pF	±0.05pF	GRM1885C2A8R3WA01#
				±0.1pF	GRM1885C2A8R3BA01#
				±0.25pF	GRM1885C2A8R3CA01#
				±0.5pF	GRM1885C2A8R3DA01#
			8.4pF	±0.05pF	GRM1885C2A8R4WA01#
				±0.1pF	GRM1885C2A8R4BA01#
				±0.25pF	GRM1885C2A8R4CA01#
				±0.5pF	GRM1885C2A8R4DA01#
			8.5pF	±0.05pF	GRM1885C2A8R5WA01#
				±0.1pF	GRM1885C2A8R5BA01#
				±0.25pF	GRM1885C2A8R5CA01#
				±0.5pF	GRM1885C2A8R5DA01#
			8.6pF	±0.05pF	GRM1885C2A8R6WA01#
				±0.1pF	GRM1885C2A8R6BA01#
				±0.25pF	GRM1885C2A8R6CA01#
				±0.5pF	GRM1885C2A8R6DA01#
			8.7pF	±0.05pF	GRM1885C2A8R7WA01#
				±0.1pF	GRM1885C2A8R7BA01#

Part number # indicates the package specification code.

For General Purpose GRM Series  
 Capacitor Array GNM Series  
 Low ESL LLI Series  
 High-Q Type GJM Series  
 High Frequency GQM Series  
 Monolithic Microchip GMA Series  
 For Bonding GMD Series  
 Product Information

## GRM Series Temperature Compensating Type Part Number List

(→ ■ 1.6x0.8mm)

T max.	Rated Voltage	TC Code	Cap.	Tol.	Part Number	T max.	Rated Voltage	TC Code	Cap.	Tol.	Part Number								
0.9mm	100Vdc	C0G	8.7pF	±0.25pF	GRM1885C2A8R7CA01#	0.9mm	100Vdc	C0G	22pF	±5%	GRM1885C2A220JA01#								
				±0.5pF	GRM1885C2A8R7DA01#					27pF	±5%	GRM1885C2A270JA01#							
			8.8pF	±0.05pF	GRM1885C2A8R8WA01#				0.9mm	100Vdc	C0G	22pF	±5%	GRM1885C2A220JA01#	33pF	±5%	GRM1885C2A330JA01#		
				±0.1pF	GRM1885C2A8R8BA01#										39pF	±5%	GRM1885C2A390JA01#		
				±0.25pF	GRM1885C2A8R8CA01#										47pF	±5%	GRM1885C2A470JA01#		
				±0.5pF	GRM1885C2A8R8DA01#										56pF	±5%	GRM1885C2A560JA01#		
				±0.05pF	GRM1885C2A8R9WA01#										68pF	±5%	GRM1885C2A680JA01#		
			8.9pF	±0.1pF	GRM1885C2A8R9BA01#				0.9mm	100Vdc	C0G	27pF	±5%	GRM1885C2A270JA01#	82pF	±5%	GRM1885C2A820JA01#		
				±0.25pF	GRM1885C2A8R9CA01#										100pF	±5%	GRM1885C2A101JA01#		
				±0.5pF	GRM1885C2A8R9DA01#										120pF	±5%	GRM1885C2A121JA01#		
				±0.05pF	GRM1885C2A9R0WA01#										150pF	±5%	GRM1885C2A151JA01#		
			9.0pF	±0.1pF	GRM1885C2A9R0BA01#				0.9mm	100Vdc	C0G	180pF	±5%	GRM1885C2A181JA01#	220pF	±5%	GRM1885C2A221JA01#		
				±0.25pF	GRM1885C2A9R0CA01#										270pF	±5%	GRM1885C2A271JA01#		
				±0.5pF	GRM1885C2A9R0DA01#										330pF	±5%	GRM1885C2A331JA01#		
				±0.05pF	GRM1885C2A9R1WA01#										390pF	±5%	GRM1885C2A391JA01#		
			9.1pF	±0.1pF	GRM1885C2A9R1BA01#				0.9mm	100Vdc	C0G	470pF	±5%	GRM1885C2A471JA01#	560pF	±5%	GRM1885C2A561JA01#		
				±0.25pF	GRM1885C2A9R1CA01#										680pF	±5%	GRM1885C2A681JA01#		
				±0.5pF	GRM1885C2A9R1DA01#										820pF	±5%	GRM1885C2A821JA01#		
				±0.05pF	GRM1885C2A9R2WA01#										1000pF	±5%	GRM1885C2A102JA01#		
			9.2pF	±0.1pF	GRM1885C2A9R2BA01#				0.9mm	100Vdc	C0G	1200pF	±5%	GRM1885C2A122JA01#	1500pF	±5%	GRM1885C2A152JA01#		
				±0.25pF	GRM1885C2A9R2CA01#										CK	0.5pF	±0.05pF	GRM1884C2AR50WA01#	
				±0.5pF	GRM1885C2A9R2DA01#												±0.1pF	GRM1884C2AR50BA01#	
				±0.05pF	GRM1885C2A9R3WA01#										0.6pF	±0.05pF	GRM1884C2AR60WA01#		
			±0.1pF	GRM1885C2A9R3BA01#	±0.1pF				GRM1884C2AR60BA01#										
			±0.25pF	GRM1885C2A9R3CA01#	0.7pF				±0.05pF	GRM1884C2AR70WA01#									
			±0.5pF	GRM1885C2A9R3DA01#					±0.1pF	GRM1884C2AR70BA01#									
			9.4pF	±0.05pF	GRM1885C2A9R4WA01#				0.9mm	100Vdc	C0G	0.8pF	±0.05pF	GRM1884C2AR80WA01#	±0.1pF	GRM1884C2AR80BA01#			
				±0.1pF	GRM1885C2A9R4BA01#										0.9pF	±0.05pF	GRM1884C2AR90WA01#		
				±0.25pF	GRM1885C2A9R4CA01#											±0.1pF	GRM1884C2AR90BA01#		
			9.5pF	±0.5pF	GRM1885C2A9R5DA01#				0.9mm	100Vdc	C0G	1.0pF	±0.05pF	GRM1884C2A1R0WA01#	±0.1pF	GRM1884C2A1R0BA01#			
				±0.05pF	GRM1885C2A9R6WA01#										±0.25pF	GRM1884C2A1R0CA01#			
				±0.1pF	GRM1885C2A9R6BA01#												1.1pF	±0.05pF	GRM1884C2A1R1WA01#
				±0.25pF	GRM1885C2A9R6CA01#													±0.1pF	GRM1884C2A1R1BA01#
			9.6pF	±0.5pF	GRM1885C2A9R6DA01#				0.9mm	100Vdc	C0G	1.2pF	±0.05pF	GRM1884C2A1R2WA01#	±0.25pF	GRM1884C2A1R1CA01#			
				±0.05pF	GRM1885C2A9R7WA01#										±0.25pF	GRM1884C2A1R2CA01#			
				±0.1pF	GRM1885C2A9R7BA01#												1.3pF	±0.05pF	GRM1884C2A1R3WA01#
				±0.25pF	GRM1885C2A9R7CA01#													±0.1pF	GRM1884C2A1R3BA01#
			9.7pF	±0.5pF	GRM1885C2A9R7DA01#				0.9mm	100Vdc	C0G	1.4pF	±0.05pF	GRM1884C2A1R4WA01#	±0.25pF	GRM1884C2A1R3CA01#			
				±0.05pF	GRM1885C2A9R8WA01#										±0.25pF	GRM1884C2A1R4CA01#			
				±0.1pF	GRM1885C2A9R8BA01#												1.5pF	±0.05pF	GRM1884C2A1R5WA01#
				±0.25pF	GRM1885C2A9R8CA01#													±0.1pF	GRM1884C2A1R5BA01#
			9.8pF	±0.5pF	GRM1885C2A9R8DA01#				0.9mm	100Vdc	C0G	1.6pF	±0.05pF	GRM1884C2A1R6WA01#	±0.25pF	GRM1884C2A1R5CA01#			
				±0.05pF	GRM1885C2A9R9WA01#										±0.25pF	GRM1884C2A1R6CA01#			
				±0.1pF	GRM1885C2A9R9BA01#												10pF	±5%	GRM1885C2A100JA01#
				±0.25pF	GRM1885C2A9R9CA01#													12pF	±5%
			9.9pF	±0.5pF	GRM1885C2A9R9DA01#				0.9mm	100Vdc	C0G	15pF	±5%	GRM1885C2A150JA01#	18pF	±5%	GRM1885C2A180JA01#		

Part number # indicates the package specification code.



## GRM Series Temperature Compensating Type Part Number List

(→ ■ 1.6x0.8mm)

T max.	Rated Voltage	TC Code	Cap.	Tol.	Part Number	
0.9mm	100Vdc	CK	1.7pF	±0.05pF	GRM1884C2A1R7WA01#	
				±0.1pF	GRM1884C2A1R7BA01#	
				±0.25pF	GRM1884C2A1R7CA01#	
			1.8pF	±0.05pF	GRM1884C2A1R8WA01#	
				±0.1pF	GRM1884C2A1R8BA01#	
				±0.25pF	GRM1884C2A1R8CA01#	
			1.9pF	±0.05pF	GRM1884C2A1R9WA01#	
				±0.1pF	GRM1884C2A1R9BA01#	
				±0.25pF	GRM1884C2A1R9CA01#	
			2.0pF	±0.05pF	GRM1884C2A2R0WA01#	
				±0.1pF	GRM1884C2A2R0BA01#	
				±0.25pF	GRM1884C2A2R0CA01#	
			CJ	2.1pF	±0.05pF	GRM1883C2A2R1WA01#
					±0.1pF	GRM1883C2A2R1BA01#
					±0.25pF	GRM1883C2A2R1CA01#
				2.2pF	±0.05pF	GRM1883C2A2R2WA01#
					±0.1pF	GRM1883C2A2R2BA01#
					±0.25pF	GRM1883C2A2R2CA01#
				2.3pF	±0.05pF	GRM1883C2A2R3WA01#
					±0.1pF	GRM1883C2A2R3BA01#
					±0.25pF	GRM1883C2A2R3CA01#
				2.4pF	±0.05pF	GRM1883C2A2R4WA01#
					±0.1pF	GRM1883C2A2R4BA01#
					±0.25pF	GRM1883C2A2R4CA01#
		2.5pF		±0.05pF	GRM1883C2A2R5WA01#	
				±0.1pF	GRM1883C2A2R5BA01#	
				±0.25pF	GRM1883C2A2R5CA01#	
		2.6pF		±0.05pF	GRM1883C2A2R6WA01#	
				±0.1pF	GRM1883C2A2R6BA01#	
				±0.25pF	GRM1883C2A2R6CA01#	
		2.7pF		±0.05pF	GRM1883C2A2R7WA01#	
				±0.1pF	GRM1883C2A2R7BA01#	
				±0.25pF	GRM1883C2A2R7CA01#	
		2.8pF		±0.05pF	GRM1883C2A2R8WA01#	
				±0.1pF	GRM1883C2A2R8BA01#	
				±0.25pF	GRM1883C2A2R8CA01#	
		2.9pF	±0.05pF	GRM1883C2A2R9WA01#		
			±0.1pF	GRM1883C2A2R9BA01#		
			±0.25pF	GRM1883C2A2R9CA01#		
		3.0pF	±0.05pF	GRM1883C2A3R0WA01#		
			±0.1pF	GRM1883C2A3R0BA01#		
			±0.25pF	GRM1883C2A3R0CA01#		
		3.1pF	±0.05pF	GRM1883C2A3R1WA01#		
			±0.1pF	GRM1883C2A3R1BA01#		
			±0.25pF	GRM1883C2A3R1CA01#		
		3.2pF	±0.05pF	GRM1883C2A3R2WA01#		
			±0.1pF	GRM1883C2A3R2BA01#		
			±0.25pF	GRM1883C2A3R2CA01#		
3.3pF	±0.05pF	GRM1883C2A3R3WA01#				
	±0.1pF	GRM1883C2A3R3BA01#				
	±0.25pF	GRM1883C2A3R3CA01#				
3.4pF	±0.05pF	GRM1883C2A3R4WA01#				
	±0.1pF	GRM1883C2A3R4BA01#				
	±0.25pF	GRM1883C2A3R4CA01#				

T max.	Rated Voltage	TC Code	Cap.	Tol.	Part Number	
0.9mm	100Vdc	CJ	3.5pF	±0.05pF	GRM1883C2A3R5WA01#	
				±0.1pF	GRM1883C2A3R5BA01#	
				±0.25pF	GRM1883C2A3R5CA01#	
			3.6pF	±0.05pF	GRM1883C2A3R6WA01#	
				±0.1pF	GRM1883C2A3R6BA01#	
				±0.25pF	GRM1883C2A3R6CA01#	
			3.7pF	±0.05pF	GRM1883C2A3R7WA01#	
				±0.1pF	GRM1883C2A3R7BA01#	
				±0.25pF	GRM1883C2A3R7CA01#	
			3.8pF	±0.05pF	GRM1883C2A3R8WA01#	
				±0.1pF	GRM1883C2A3R8BA01#	
				±0.25pF	GRM1883C2A3R8CA01#	
			3.9pF	±0.05pF	GRM1883C2A3R9WA01#	
				±0.1pF	GRM1883C2A3R9BA01#	
				±0.25pF	GRM1883C2A3R9CA01#	
			CH	4.0pF	±0.05pF	GRM1882C2A4R0WA01#
					±0.1pF	GRM1882C2A4R0BA01#
					±0.25pF	GRM1882C2A4R0CA01#
				4.1pF	±0.05pF	GRM1882C2A4R1WA01#
					±0.1pF	GRM1882C2A4R1BA01#
					±0.25pF	GRM1882C2A4R1CA01#
				4.2pF	±0.05pF	GRM1882C2A4R2WA01#
					±0.1pF	GRM1882C2A4R2BA01#
					±0.25pF	GRM1882C2A4R2CA01#
		4.3pF		±0.05pF	GRM1882C2A4R3WA01#	
				±0.1pF	GRM1882C2A4R3BA01#	
				±0.25pF	GRM1882C2A4R3CA01#	
		4.4pF		±0.05pF	GRM1882C2A4R4WA01#	
				±0.1pF	GRM1882C2A4R4BA01#	
				±0.25pF	GRM1882C2A4R4CA01#	
		4.5pF		±0.05pF	GRM1882C2A4R5WA01#	
				±0.1pF	GRM1882C2A4R5BA01#	
				±0.25pF	GRM1882C2A4R5CA01#	
		4.6pF		±0.05pF	GRM1882C2A4R6WA01#	
				±0.1pF	GRM1882C2A4R6BA01#	
				±0.25pF	GRM1882C2A4R6CA01#	
		4.7pF		±0.05pF	GRM1882C2A4R7WA01#	
				±0.1pF	GRM1882C2A4R7BA01#	
				±0.25pF	GRM1882C2A4R7CA01#	
		4.8pF	±0.05pF	GRM1882C2A4R8WA01#		
			±0.1pF	GRM1882C2A4R8BA01#		
			±0.25pF	GRM1882C2A4R8CA01#		
		4.9pF	±0.05pF	GRM1882C2A4R9WA01#		
			±0.1pF	GRM1882C2A4R9BA01#		
			±0.25pF	GRM1882C2A4R9CA01#		
		5.0pF	±0.05pF	GRM1882C2A5R0WA01#		
			±0.1pF	GRM1882C2A5R0BA01#		
			±0.25pF	GRM1882C2A5R0CA01#		
5.1pF	±0.05pF	GRM1882C2A5R1WA01#				
	±0.1pF	GRM1882C2A5R1BA01#				
	±0.25pF	GRM1882C2A5R1CA01#				
5.2pF	±0.05pF	GRM1882C2A5R2WA01#				
	±0.1pF	GRM1882C2A5R2BA01#				

Part number # indicates the package specification code.

For General Purpose GRM Series  
 Capacitor Array GNM Series  
 Low ESL LL Series  
 High-Q Type GJM Series  
 High Frequency GQM Series  
 Monolithic Microchip GMA Series  
 For Bonding GMD Series  
 Product Information

## GRM Series Temperature Compensating Type Part Number List

(→ ■ 1.6x0.8mm)

T max.	Rated Voltage	TC Code	Cap.	Tol.	Part Number
0.9mm	100Vdc	CH	5.2pF	±0.25pF	GRM1882C2A5R2CA01#
				±0.5pF	GRM1882C2A5R2DA01#
			5.3pF	±0.05pF	GRM1882C2A5R3WA01#
				±0.1pF	GRM1882C2A5R3BA01#
				±0.25pF	GRM1882C2A5R3CA01#
				±0.5pF	GRM1882C2A5R3DA01#
			5.4pF	±0.05pF	GRM1882C2A5R4WA01#
				±0.1pF	GRM1882C2A5R4BA01#
				±0.25pF	GRM1882C2A5R4CA01#
				±0.5pF	GRM1882C2A5R4DA01#
			5.5pF	±0.05pF	GRM1882C2A5R5WA01#
				±0.1pF	GRM1882C2A5R5BA01#
				±0.25pF	GRM1882C2A5R5CA01#
				±0.5pF	GRM1882C2A5R5DA01#
			5.6pF	±0.05pF	GRM1882C2A5R6WA01#
				±0.1pF	GRM1882C2A5R6BA01#
				±0.25pF	GRM1882C2A5R6CA01#
				±0.5pF	GRM1882C2A5R6DA01#
			5.7pF	±0.05pF	GRM1882C2A5R7WA01#
				±0.1pF	GRM1882C2A5R7BA01#
				±0.25pF	GRM1882C2A5R7CA01#
				±0.5pF	GRM1882C2A5R7DA01#
			5.8pF	±0.05pF	GRM1882C2A5R8WA01#
				±0.1pF	GRM1882C2A5R8BA01#
				±0.25pF	GRM1882C2A5R8CA01#
				±0.5pF	GRM1882C2A5R8DA01#
			5.9pF	±0.05pF	GRM1882C2A5R9WA01#
				±0.1pF	GRM1882C2A5R9BA01#
				±0.25pF	GRM1882C2A5R9CA01#
				±0.5pF	GRM1882C2A5R9DA01#
			6.0pF	±0.05pF	GRM1882C2A6R0WA01#
				±0.1pF	GRM1882C2A6R0BA01#
				±0.25pF	GRM1882C2A6R0CA01#
				±0.5pF	GRM1882C2A6R0DA01#
			6.1pF	±0.05pF	GRM1882C2A6R1WA01#
				±0.1pF	GRM1882C2A6R1BA01#
				±0.25pF	GRM1882C2A6R1CA01#
				±0.5pF	GRM1882C2A6R1DA01#
			6.2pF	±0.05pF	GRM1882C2A6R2WA01#
				±0.1pF	GRM1882C2A6R2BA01#
				±0.25pF	GRM1882C2A6R2CA01#
				±0.5pF	GRM1882C2A6R2DA01#
			6.3pF	±0.05pF	GRM1882C2A6R3WA01#
				±0.1pF	GRM1882C2A6R3BA01#
				±0.25pF	GRM1882C2A6R3CA01#
				±0.5pF	GRM1882C2A6R3DA01#
			6.4pF	±0.05pF	GRM1882C2A6R4WA01#
				±0.1pF	GRM1882C2A6R4BA01#
				±0.25pF	GRM1882C2A6R4CA01#
				±0.5pF	GRM1882C2A6R4DA01#
			6.5pF	±0.05pF	GRM1882C2A6R5WA01#
				±0.1pF	GRM1882C2A6R5BA01#
				±0.25pF	GRM1882C2A6R5CA01#
				±0.5pF	GRM1882C2A6R5DA01#

T max.	Rated Voltage	TC Code	Cap.	Tol.	Part Number
0.9mm	100Vdc	CH	6.6pF	±0.05pF	GRM1882C2A6R6WA01#
				±0.1pF	GRM1882C2A6R6BA01#
				±0.25pF	GRM1882C2A6R6CA01#
				±0.5pF	GRM1882C2A6R6DA01#
			6.7pF	±0.05pF	GRM1882C2A6R7WA01#
				±0.1pF	GRM1882C2A6R7BA01#
				±0.25pF	GRM1882C2A6R7CA01#
				±0.5pF	GRM1882C2A6R7DA01#
			6.8pF	±0.05pF	GRM1882C2A6R8WA01#
				±0.1pF	GRM1882C2A6R8BA01#
				±0.25pF	GRM1882C2A6R8CA01#
				±0.5pF	GRM1882C2A6R8DA01#
			6.9pF	±0.05pF	GRM1882C2A6R9WA01#
				±0.1pF	GRM1882C2A6R9BA01#
				±0.25pF	GRM1882C2A6R9CA01#
				±0.5pF	GRM1882C2A6R9DA01#
			7.0pF	±0.05pF	GRM1882C2A7R0WA01#
				±0.1pF	GRM1882C2A7R0BA01#
				±0.25pF	GRM1882C2A7R0CA01#
				±0.5pF	GRM1882C2A7R0DA01#
			7.1pF	±0.05pF	GRM1882C2A7R1WA01#
				±0.1pF	GRM1882C2A7R1BA01#
				±0.25pF	GRM1882C2A7R1CA01#
				±0.5pF	GRM1882C2A7R1DA01#
			7.2pF	±0.05pF	GRM1882C2A7R2WA01#
				±0.1pF	GRM1882C2A7R2BA01#
				±0.25pF	GRM1882C2A7R2CA01#
				±0.5pF	GRM1882C2A7R2DA01#
			7.3pF	±0.05pF	GRM1882C2A7R3WA01#
				±0.1pF	GRM1882C2A7R3BA01#
				±0.25pF	GRM1882C2A7R3CA01#
				±0.5pF	GRM1882C2A7R3DA01#
			7.4pF	±0.05pF	GRM1882C2A7R4WA01#
				±0.1pF	GRM1882C2A7R4BA01#
				±0.25pF	GRM1882C2A7R4CA01#
				±0.5pF	GRM1882C2A7R4DA01#
			7.5pF	±0.05pF	GRM1882C2A7R5WA01#
				±0.1pF	GRM1882C2A7R5BA01#
				±0.25pF	GRM1882C2A7R5CA01#
				±0.5pF	GRM1882C2A7R5DA01#
			7.6pF	±0.05pF	GRM1882C2A7R6WA01#
				±0.1pF	GRM1882C2A7R6BA01#
				±0.25pF	GRM1882C2A7R6CA01#
				±0.5pF	GRM1882C2A7R6DA01#
			7.7pF	±0.05pF	GRM1882C2A7R7WA01#
				±0.1pF	GRM1882C2A7R7BA01#
				±0.25pF	GRM1882C2A7R7CA01#
				±0.5pF	GRM1882C2A7R7DA01#
			7.8pF	±0.05pF	GRM1882C2A7R8WA01#
				±0.1pF	GRM1882C2A7R8BA01#
				±0.25pF	GRM1882C2A7R8CA01#
				±0.5pF	GRM1882C2A7R8DA01#
			7.9pF	±0.05pF	GRM1882C2A7R9WA01#
				±0.1pF	GRM1882C2A7R9BA01#

Part number # indicates the package specification code.

## GRM Series Temperature Compensating Type Part Number List

(→ ■ 1.6x0.8mm)

T max.	Rated Voltage	TC Code	Cap.	Tol.	Part Number
0.9mm	100Vdc	CH	7.9pF	±0.25pF	GRM1882C2A7R9CA01#
				±0.5pF	GRM1882C2A7R9DA01#
			8.0pF	±0.05pF	GRM1882C2A8R0WA01#
				±0.1pF	GRM1882C2A8R0BA01#
				±0.25pF	GRM1882C2A8R0CA01#
				±0.5pF	GRM1882C2A8R0DA01#
			8.1pF	±0.05pF	GRM1882C2A8R1WA01#
				±0.1pF	GRM1882C2A8R1BA01#
				±0.25pF	GRM1882C2A8R1CA01#
				±0.5pF	GRM1882C2A8R1DA01#
			8.2pF	±0.05pF	GRM1882C2A8R2WA01#
				±0.1pF	GRM1882C2A8R2BA01#
				±0.25pF	GRM1882C2A8R2CA01#
				±0.5pF	GRM1882C2A8R2DA01#
			8.3pF	±0.05pF	GRM1882C2A8R3WA01#
				±0.1pF	GRM1882C2A8R3BA01#
				±0.25pF	GRM1882C2A8R3CA01#
				±0.5pF	GRM1882C2A8R3DA01#
			8.4pF	±0.05pF	GRM1882C2A8R4WA01#
				±0.1pF	GRM1882C2A8R4BA01#
				±0.25pF	GRM1882C2A8R4CA01#
				±0.5pF	GRM1882C2A8R4DA01#
			8.5pF	±0.05pF	GRM1882C2A8R5WA01#
				±0.1pF	GRM1882C2A8R5BA01#
				±0.25pF	GRM1882C2A8R5CA01#
				±0.5pF	GRM1882C2A8R5DA01#
			8.6pF	±0.05pF	GRM1882C2A8R6WA01#
				±0.1pF	GRM1882C2A8R6BA01#
				±0.25pF	GRM1882C2A8R6CA01#
				±0.5pF	GRM1882C2A8R6DA01#
			8.7pF	±0.05pF	GRM1882C2A8R7WA01#
				±0.1pF	GRM1882C2A8R7BA01#
				±0.25pF	GRM1882C2A8R7CA01#
				±0.5pF	GRM1882C2A8R7DA01#
			8.8pF	±0.05pF	GRM1882C2A8R8WA01#
				±0.1pF	GRM1882C2A8R8BA01#
				±0.25pF	GRM1882C2A8R8CA01#
				±0.5pF	GRM1882C2A8R8DA01#
			8.9pF	±0.05pF	GRM1882C2A8R9WA01#
				±0.1pF	GRM1882C2A8R9BA01#
				±0.25pF	GRM1882C2A8R9CA01#
				±0.5pF	GRM1882C2A8R9DA01#
			9.0pF	±0.05pF	GRM1882C2A9R0WA01#
				±0.1pF	GRM1882C2A9R0BA01#
				±0.25pF	GRM1882C2A9R0CA01#
				±0.5pF	GRM1882C2A9R0DA01#
			9.1pF	±0.05pF	GRM1882C2A9R1WA01#
				±0.1pF	GRM1882C2A9R1BA01#
±0.25pF	GRM1882C2A9R1CA01#				
±0.5pF	GRM1882C2A9R1DA01#				
9.2pF	±0.05pF	GRM1882C2A9R2WA01#			
	±0.1pF	GRM1882C2A9R2BA01#			
	±0.25pF	GRM1882C2A9R2CA01#			
	±0.5pF	GRM1882C2A9R2DA01#			

T max.	Rated Voltage	TC Code	Cap.	Tol.	Part Number
0.9mm	100Vdc	CH	9.3pF	±0.05pF	GRM1882C2A9R3WA01#
				±0.1pF	GRM1882C2A9R3BA01#
				±0.25pF	GRM1882C2A9R3CA01#
				±0.5pF	GRM1882C2A9R3DA01#
			9.4pF	±0.05pF	GRM1882C2A9R4WA01#
				±0.1pF	GRM1882C2A9R4BA01#
				±0.25pF	GRM1882C2A9R4CA01#
				±0.5pF	GRM1882C2A9R4DA01#
			9.5pF	±0.05pF	GRM1882C2A9R5WA01#
				±0.1pF	GRM1882C2A9R5BA01#
				±0.25pF	GRM1882C2A9R5CA01#
				±0.5pF	GRM1882C2A9R5DA01#
			9.6pF	±0.05pF	GRM1882C2A9R6WA01#
				±0.1pF	GRM1882C2A9R6BA01#
				±0.25pF	GRM1882C2A9R6CA01#
				±0.5pF	GRM1882C2A9R6DA01#
			9.7pF	±0.05pF	GRM1882C2A9R7WA01#
				±0.1pF	GRM1882C2A9R7BA01#
				±0.25pF	GRM1882C2A9R7CA01#
				±0.5pF	GRM1882C2A9R7DA01#
			9.8pF	±0.05pF	GRM1882C2A9R8WA01#
				±0.1pF	GRM1882C2A9R8BA01#
				±0.25pF	GRM1882C2A9R8CA01#
				±0.5pF	GRM1882C2A9R8DA01#
			9.9pF	±0.05pF	GRM1882C2A9R9WA01#
				±0.1pF	GRM1882C2A9R9BA01#
				±0.25pF	GRM1882C2A9R9CA01#
				±0.5pF	GRM1882C2A9R9DA01#
			10pF	±5%	GRM1882C2A100JA01#
			12pF	±5%	GRM1882C2A120JA01#
			15pF	±5%	GRM1882C2A150JA01#
			18pF	±5%	GRM1882C2A180JA01#
			22pF	±5%	GRM1882C2A220JA01#
			27pF	±5%	GRM1882C2A270JA01#
			33pF	±5%	GRM1882C2A330JA01#
			39pF	±5%	GRM1882C2A390JA01#
			47pF	±5%	GRM1882C2A470JA01#
			56pF	±5%	GRM1882C2A560JA01#
			68pF	±5%	GRM1882C2A680JA01#
			82pF	±5%	GRM1882C2A820JA01#
			100pF	±5%	GRM1882C2A101JA01#
			120pF	±5%	GRM1882C2A121JA01#
			150pF	±5%	GRM1882C2A151JA01#
			180pF	±5%	GRM1882C2A181JA01#
			220pF	±5%	GRM1882C2A221JA01#
			270pF	±5%	GRM1882C2A271JA01#
			330pF	±5%	GRM1882C2A331JA01#
			390pF	±5%	GRM1882C2A391JA01#
470pF	±5%	GRM1882C2A471JA01#			
560pF	±5%	GRM1882C2A561JA01#			
680pF	±5%	GRM1882C2A681JA01#			
820pF	±5%	GRM1882C2A821JA01#			
1000pF	±5%	GRM1882C2A102JA01#			
1200pF	±5%	GRM1882C2A122JA01#			

Part number # indicates the package specification code.

For General Purpose GRM Series

Capacitor Array GNM Series

Low ESL LLI Series

High-Q Type GJM Series

High Frequency GQM Series

Monolithic Microchip GMA Series

For Bonding GMD Series

Product Information

## GRM Series Temperature Compensating Type Part Number List

(→ ■ 1.6x0.8mm)

T max.	Rated Voltage	TC Code	Cap.	Tol.	Part Number
0.9mm	100Vdc	CH	1500pF	±5%	GRM1882C2A152JA01#
		50Vdc	C0G	0.5pF	±0.05pF
	±0.1pF				GRM1885C1HR50BA01#
	±0.25pF				GRM1885C1HR50CA01#
	0.6pF			±0.05pF	GRM1885C1HR60WA01#
				±0.1pF	GRM1885C1HR60BA01#
				±0.25pF	GRM1885C1HR60CA01#
	0.7pF			±0.05pF	GRM1885C1HR70WA01#
				±0.1pF	GRM1885C1HR70BA01#
				±0.25pF	GRM1885C1HR70CA01#
	0.8pF			±0.05pF	GRM1885C1HR80WA01#
				±0.1pF	GRM1885C1HR80BA01#
				±0.25pF	GRM1885C1HR80CA01#
	0.9pF			±0.05pF	GRM1885C1HR90WA01#
				±0.1pF	GRM1885C1HR90BA01#
				±0.25pF	GRM1885C1HR90CA01#
	1.0pF			±0.05pF	GRM1885C1H1R0WA01#
				±0.1pF	GRM1885C1H1R0BA01#
				±0.25pF	GRM1885C1H1R0CA01#
	1.1pF			±0.05pF	GRM1885C1H1R1WA01#
				±0.1pF	GRM1885C1H1R1BA01#
				±0.25pF	GRM1885C1H1R1CA01#
	1.2pF			±0.05pF	GRM1885C1H1R2WA01#
				±0.1pF	GRM1885C1H1R2BA01#
				±0.25pF	GRM1885C1H1R2CA01#
	1.3pF			±0.05pF	GRM1885C1H1R3WA01#
				±0.1pF	GRM1885C1H1R3BA01#
				±0.25pF	GRM1885C1H1R3CA01#
	1.4pF			±0.05pF	GRM1885C1H1R4WA01#
				±0.1pF	GRM1885C1H1R4BA01#
				±0.25pF	GRM1885C1H1R4CA01#
	1.5pF			±0.05pF	GRM1885C1H1R5WA01#
				±0.1pF	GRM1885C1H1R5BA01#
				±0.25pF	GRM1885C1H1R5CA01#
	1.6pF			±0.05pF	GRM1885C1H1R6WA01#
				±0.1pF	GRM1885C1H1R6BA01#
				±0.25pF	GRM1885C1H1R6CA01#
	1.7pF			±0.05pF	GRM1885C1H1R7WA01#
				±0.1pF	GRM1885C1H1R7BA01#
				±0.25pF	GRM1885C1H1R7CA01#
	1.8pF			±0.05pF	GRM1885C1H1R8WA01#
				±0.1pF	GRM1885C1H1R8BA01#
				±0.25pF	GRM1885C1H1R8CA01#
	1.9pF			±0.05pF	GRM1885C1H1R9WA01#
				±0.1pF	GRM1885C1H1R9BA01#
				±0.25pF	GRM1885C1H1R9CA01#
	2.0pF			±0.05pF	GRM1885C1H2R0WA01#
		±0.1pF	GRM1885C1H2R0BA01#		
±0.25pF		GRM1885C1H2R0CA01#			
2.1pF	±0.05pF	GRM1885C1H2R1WA01#			
	±0.1pF	GRM1885C1H2R1BA01#			
	±0.25pF	GRM1885C1H2R1CA01#			
2.2pF	±0.05pF	GRM1885C1H2R2WA01#			
	±0.1pF	GRM1885C1H2R2BA01#			
	±0.25pF	GRM1885C1H2R2CA01#			
2.3pF	±0.05pF	GRM1885C1H2R3WA01#			
	±0.1pF	GRM1885C1H2R3BA01#			
	±0.25pF	GRM1885C1H2R3CA01#			
2.4pF	±0.05pF	GRM1885C1H2R4WA01#			

T max.	Rated Voltage	TC Code	Cap.	Tol.	Part Number
0.9mm	50Vdc	C0G	2.4pF	±0.1pF	GRM1885C1H2R4BA01#
				±0.25pF	GRM1885C1H2R4CA01#
			2.5pF	±0.05pF	GRM1885C1H2R5WA01#
				±0.1pF	GRM1885C1H2R5BA01#
				±0.25pF	GRM1885C1H2R5CA01#
			2.6pF	±0.05pF	GRM1885C1H2R6WA01#
				±0.1pF	GRM1885C1H2R6BA01#
				±0.25pF	GRM1885C1H2R6CA01#
			2.7pF	±0.05pF	GRM1885C1H2R7WA01#
				±0.1pF	GRM1885C1H2R7BA01#
				±0.25pF	GRM1885C1H2R7CA01#
			2.8pF	±0.05pF	GRM1885C1H2R8WA01#
				±0.1pF	GRM1885C1H2R8BA01#
				±0.25pF	GRM1885C1H2R8CA01#
			2.9pF	±0.05pF	GRM1885C1H2R9WA01#
				±0.1pF	GRM1885C1H2R9BA01#
				±0.25pF	GRM1885C1H2R9CA01#
			3.0pF	±0.05pF	GRM1885C1H3R0WA01#
				±0.1pF	GRM1885C1H3R0BA01#
				±0.25pF	GRM1885C1H3R0CA01#
			3.1pF	±0.05pF	GRM1885C1H3R1WA01#
				±0.1pF	GRM1885C1H3R1BA01#
				±0.25pF	GRM1885C1H3R1CA01#
			3.2pF	±0.05pF	GRM1885C1H3R2WA01#
				±0.1pF	GRM1885C1H3R2BA01#
				±0.25pF	GRM1885C1H3R2CA01#
			3.3pF	±0.05pF	GRM1885C1H3R3WA01#
				±0.1pF	GRM1885C1H3R3BA01#
				±0.25pF	GRM1885C1H3R3CA01#
			3.4pF	±0.05pF	GRM1885C1H3R4WA01#
				±0.1pF	GRM1885C1H3R4BA01#
				±0.25pF	GRM1885C1H3R4CA01#
			3.5pF	±0.05pF	GRM1885C1H3R5WA01#
				±0.1pF	GRM1885C1H3R5BA01#
				±0.25pF	GRM1885C1H3R5CA01#
			3.6pF	±0.05pF	GRM1885C1H3R6WA01#
				±0.1pF	GRM1885C1H3R6BA01#
				±0.25pF	GRM1885C1H3R6CA01#
			3.7pF	±0.05pF	GRM1885C1H3R7WA01#
				±0.1pF	GRM1885C1H3R7BA01#
				±0.25pF	GRM1885C1H3R7CA01#
			3.8pF	±0.05pF	GRM1885C1H3R8WA01#
				±0.1pF	GRM1885C1H3R8BA01#
				±0.25pF	GRM1885C1H3R8CA01#
			3.9pF	±0.05pF	GRM1885C1H3R9WA01#
				±0.1pF	GRM1885C1H3R9BA01#
				±0.25pF	GRM1885C1H3R9CA01#
			4.0pF	±0.05pF	GRM1885C1H4R0WA01#
±0.1pF	GRM1885C1H4R0BA01#				
±0.25pF	GRM1885C1H4R0CA01#				
4.1pF	±0.05pF	GRM1885C1H4R1WA01#			
	±0.1pF	GRM1885C1H4R1BA01#			
	±0.25pF	GRM1885C1H4R1CA01#			
4.2pF	±0.05pF	GRM1885C1H4R2WA01#			

Part number # indicates the package specification code.



## GRM Series Temperature Compensating Type Part Number List

(→ ■ 1.6x0.8mm)

T max.	Rated Voltage	TC Code	Cap.	Tol.	Part Number
0.9mm	50Vdc	C0G	4.2pF	±0.1pF	GRM1885C1H4R2BA01#
				±0.25pF	GRM1885C1H4R2CA01#
			4.3pF	±0.05pF	GRM1885C1H4R3WA01#
				±0.1pF	GRM1885C1H4R3BA01#
			4.4pF	±0.05pF	GRM1885C1H4R4WA01#
				±0.1pF	GRM1885C1H4R4BA01#
			4.5pF	±0.05pF	GRM1885C1H4R5WA01#
				±0.1pF	GRM1885C1H4R5BA01#
			4.6pF	±0.05pF	GRM1885C1H4R6WA01#
				±0.1pF	GRM1885C1H4R6BA01#
			4.7pF	±0.05pF	GRM1885C1H4R7WA01#
				±0.1pF	GRM1885C1H4R7BA01#
			4.8pF	±0.05pF	GRM1885C1H4R8WA01#
				±0.1pF	GRM1885C1H4R8BA01#
			4.9pF	±0.05pF	GRM1885C1H4R9WA01#
				±0.1pF	GRM1885C1H4R9BA01#
			5.0pF	±0.05pF	GRM1885C1H5R0WA01#
				±0.1pF	GRM1885C1H5R0BA01#
			5.1pF	±0.05pF	GRM1885C1H5R1WA01#
				±0.1pF	GRM1885C1H5R1BA01#
			5.2pF	±0.05pF	GRM1885C1H5R2WA01#
				±0.1pF	GRM1885C1H5R2BA01#
			5.3pF	±0.05pF	GRM1885C1H5R3WA01#
				±0.1pF	GRM1885C1H5R3BA01#
			5.4pF	±0.05pF	GRM1885C1H5R4WA01#
				±0.1pF	GRM1885C1H5R4BA01#
			5.5pF	±0.05pF	GRM1885C1H5R5WA01#
				±0.1pF	GRM1885C1H5R5BA01#
			5.6pF	±0.05pF	GRM1885C1H5R6WA01#
				±0.1pF	GRM1885C1H5R6BA01#
			5.7pF	±0.05pF	GRM1885C1H5R7WA01#
				±0.1pF	GRM1885C1H5R7BA01#

T max.	Rated Voltage	TC Code	Cap.	Tol.	Part Number
0.9mm	50Vdc	C0G	5.8pF	±0.05pF	GRM1885C1H5R8WA01#
				±0.1pF	GRM1885C1H5R8BA01#
				±0.25pF	GRM1885C1H5R8CA01#
				±0.5pF	GRM1885C1H5R8DA01#
			5.9pF	±0.05pF	GRM1885C1H5R9WA01#
				±0.1pF	GRM1885C1H5R9BA01#
				±0.25pF	GRM1885C1H5R9CA01#
				±0.5pF	GRM1885C1H5R9DA01#
			6.0pF	±0.05pF	GRM1885C1H6R0WA01#
				±0.1pF	GRM1885C1H6R0BA01#
				±0.25pF	GRM1885C1H6R0CA01#
				±0.5pF	GRM1885C1H6R0DA01#
			6.1pF	±0.05pF	GRM1885C1H6R1WA01#
				±0.1pF	GRM1885C1H6R1BA01#
				±0.25pF	GRM1885C1H6R1CA01#
				±0.5pF	GRM1885C1H6R1DA01#
			6.2pF	±0.05pF	GRM1885C1H6R2WA01#
				±0.1pF	GRM1885C1H6R2BA01#
				±0.25pF	GRM1885C1H6R2CA01#
				±0.5pF	GRM1885C1H6R2DA01#
			6.3pF	±0.05pF	GRM1885C1H6R3WA01#
				±0.1pF	GRM1885C1H6R3BA01#
				±0.25pF	GRM1885C1H6R3CA01#
				±0.5pF	GRM1885C1H6R3DA01#
			6.4pF	±0.05pF	GRM1885C1H6R4WA01#
				±0.1pF	GRM1885C1H6R4BA01#
				±0.25pF	GRM1885C1H6R4CA01#
				±0.5pF	GRM1885C1H6R4DA01#
			6.5pF	±0.05pF	GRM1885C1H6R5WA01#
				±0.1pF	GRM1885C1H6R5BA01#
				±0.25pF	GRM1885C1H6R5CA01#
				±0.5pF	GRM1885C1H6R5DA01#
			6.6pF	±0.05pF	GRM1885C1H6R6WA01#
				±0.1pF	GRM1885C1H6R6BA01#
				±0.25pF	GRM1885C1H6R6CA01#
				±0.5pF	GRM1885C1H6R6DA01#
			6.7pF	±0.05pF	GRM1885C1H6R7WA01#
				±0.1pF	GRM1885C1H6R7BA01#
				±0.25pF	GRM1885C1H6R7CA01#
				±0.5pF	GRM1885C1H6R7DA01#
			6.8pF	±0.05pF	GRM1885C1H6R8WA01#
				±0.1pF	GRM1885C1H6R8BA01#
±0.25pF	GRM1885C1H6R8CA01#				
±0.5pF	GRM1885C1H6R8DA01#				
6.9pF	±0.05pF	GRM1885C1H6R9WA01#			
	±0.1pF	GRM1885C1H6R9BA01#			
	±0.25pF	GRM1885C1H6R9CA01#			
	±0.5pF	GRM1885C1H6R9DA01#			
7.0pF	±0.05pF	GRM1885C1H7R0WA01#			
	±0.1pF	GRM1885C1H7R0BA01#			
	±0.25pF	GRM1885C1H7R0CA01#			
	±0.5pF	GRM1885C1H7R0DA01#			
7.1pF	±0.05pF	GRM1885C1H7R1WA01#			
	±0.1pF	GRM1885C1H7R1BA01#			

Part number # indicates the package specification code.

For General Purpose GRM Series  
 Capacitor Array GNM Series  
 Low ESL LLI Series  
 High-Q Type GJM Series  
 High Frequency GQM Series  
 Monolithic Microchip GMA Series  
 For Bonding GMD Series  
 Product Information

## GRM Series Temperature Compensating Type Part Number List

(→ ■ 1.6x0.8mm)

T max.	Rated Voltage	TC Code	Cap.	Tol.	Part Number
0.9mm	50Vdc	C0G	7.1pF	±0.25pF	GRM1885C1H7R1CA01#
				±0.5pF	GRM1885C1H7R1DA01#
			7.2pF	±0.05pF	GRM1885C1H7R2WA01#
				±0.1pF	GRM1885C1H7R2BA01#
				±0.25pF	GRM1885C1H7R2CA01#
				±0.5pF	GRM1885C1H7R2DA01#
			7.3pF	±0.05pF	GRM1885C1H7R3WA01#
				±0.1pF	GRM1885C1H7R3BA01#
				±0.25pF	GRM1885C1H7R3CA01#
				±0.5pF	GRM1885C1H7R3DA01#
			7.4pF	±0.05pF	GRM1885C1H7R4WA01#
				±0.1pF	GRM1885C1H7R4BA01#
				±0.25pF	GRM1885C1H7R4CA01#
				±0.5pF	GRM1885C1H7R4DA01#
			7.5pF	±0.05pF	GRM1885C1H7R5WA01#
				±0.1pF	GRM1885C1H7R5BA01#
				±0.25pF	GRM1885C1H7R5CA01#
				±0.5pF	GRM1885C1H7R5DA01#
			7.6pF	±0.05pF	GRM1885C1H7R6WA01#
				±0.1pF	GRM1885C1H7R6BA01#
				±0.25pF	GRM1885C1H7R6CA01#
				±0.5pF	GRM1885C1H7R6DA01#
			7.7pF	±0.05pF	GRM1885C1H7R7WA01#
				±0.1pF	GRM1885C1H7R7BA01#
				±0.25pF	GRM1885C1H7R7CA01#
				±0.5pF	GRM1885C1H7R7DA01#
			7.8pF	±0.05pF	GRM1885C1H7R8WA01#
				±0.1pF	GRM1885C1H7R8BA01#
				±0.25pF	GRM1885C1H7R8CA01#
				±0.5pF	GRM1885C1H7R8DA01#
			7.9pF	±0.05pF	GRM1885C1H7R9WA01#
				±0.1pF	GRM1885C1H7R9BA01#
				±0.25pF	GRM1885C1H7R9CA01#
				±0.5pF	GRM1885C1H7R9DA01#
			8.0pF	±0.05pF	GRM1885C1H8R0WA01#
				±0.1pF	GRM1885C1H8R0BA01#
				±0.25pF	GRM1885C1H8R0CA01#
				±0.5pF	GRM1885C1H8R0DA01#
			8.1pF	±0.05pF	GRM1885C1H8R1WA01#
				±0.1pF	GRM1885C1H8R1BA01#
				±0.25pF	GRM1885C1H8R1CA01#
				±0.5pF	GRM1885C1H8R1DA01#
			8.2pF	±0.05pF	GRM1885C1H8R2WA01#
				±0.1pF	GRM1885C1H8R2BA01#
				±0.25pF	GRM1885C1H8R2CA01#
				±0.5pF	GRM1885C1H8R2DA01#
			8.3pF	±0.05pF	GRM1885C1H8R3WA01#
				±0.1pF	GRM1885C1H8R3BA01#
±0.25pF	GRM1885C1H8R3CA01#				
±0.5pF	GRM1885C1H8R3DA01#				
8.4pF	±0.05pF	GRM1885C1H8R4WA01#			
	±0.1pF	GRM1885C1H8R4BA01#			
	±0.25pF	GRM1885C1H8R4CA01#			
	±0.5pF	GRM1885C1H8R4DA01#			

T max.	Rated Voltage	TC Code	Cap.	Tol.	Part Number
0.9mm	50Vdc	C0G	8.5pF	±0.05pF	GRM1885C1H8R5WA01#
				±0.1pF	GRM1885C1H8R5BA01#
				±0.25pF	GRM1885C1H8R5CA01#
				±0.5pF	GRM1885C1H8R5DA01#
			8.6pF	±0.05pF	GRM1885C1H8R6WA01#
				±0.1pF	GRM1885C1H8R6BA01#
				±0.25pF	GRM1885C1H8R6CA01#
				±0.5pF	GRM1885C1H8R6DA01#
			8.7pF	±0.05pF	GRM1885C1H8R7WA01#
				±0.1pF	GRM1885C1H8R7BA01#
				±0.25pF	GRM1885C1H8R7CA01#
				±0.5pF	GRM1885C1H8R7DA01#
			8.8pF	±0.05pF	GRM1885C1H8R8WA01#
				±0.1pF	GRM1885C1H8R8BA01#
				±0.25pF	GRM1885C1H8R8CA01#
				±0.5pF	GRM1885C1H8R8DA01#
			8.9pF	±0.05pF	GRM1885C1H8R9WA01#
				±0.1pF	GRM1885C1H8R9BA01#
				±0.25pF	GRM1885C1H8R9CA01#
				±0.5pF	GRM1885C1H8R9DA01#
			9.0pF	±0.05pF	GRM1885C1H9R0WA01#
				±0.1pF	GRM1885C1H9R0BA01#
				±0.25pF	GRM1885C1H9R0CA01#
				±0.5pF	GRM1885C1H9R0DA01#
			9.1pF	±0.05pF	GRM1885C1H9R1WA01#
				±0.1pF	GRM1885C1H9R1BA01#
				±0.25pF	GRM1885C1H9R1CA01#
				±0.5pF	GRM1885C1H9R1DA01#
			9.2pF	±0.05pF	GRM1885C1H9R2WA01#
				±0.1pF	GRM1885C1H9R2BA01#
				±0.25pF	GRM1885C1H9R2CA01#
				±0.5pF	GRM1885C1H9R2DA01#
			9.3pF	±0.05pF	GRM1885C1H9R3WA01#
				±0.1pF	GRM1885C1H9R3BA01#
				±0.25pF	GRM1885C1H9R3CA01#
				±0.5pF	GRM1885C1H9R3DA01#
			9.4pF	±0.05pF	GRM1885C1H9R4WA01#
				±0.1pF	GRM1885C1H9R4BA01#
				±0.25pF	GRM1885C1H9R4CA01#
				±0.5pF	GRM1885C1H9R4DA01#
			9.5pF	±0.05pF	GRM1885C1H9R5WA01#
				±0.1pF	GRM1885C1H9R5BA01#
				±0.25pF	GRM1885C1H9R5CA01#
				±0.5pF	GRM1885C1H9R5DA01#
			9.6pF	±0.05pF	GRM1885C1H9R6WA01#
				±0.1pF	GRM1885C1H9R6BA01#
				±0.25pF	GRM1885C1H9R6CA01#
				±0.5pF	GRM1885C1H9R6DA01#
9.7pF	±0.05pF	GRM1885C1H9R7WA01#			
	±0.1pF	GRM1885C1H9R7BA01#			
	±0.25pF	GRM1885C1H9R7CA01#			
	±0.5pF	GRM1885C1H9R7DA01#			
9.8pF	±0.05pF	GRM1885C1H9R8WA01#			
	±0.1pF	GRM1885C1H9R8BA01#			

Part number # indicates the package specification code.

## GRM Series Temperature Compensating Type Part Number List

(→ ■ 1.6x0.8mm)

T max.	Rated Voltage	TC Code	Cap.	Tol.	Part Number			
0.9mm	50Vdc	C0G	9.8pF	±0.25pF	GRM1885C1H9R8CA01#			
				±0.5pF	GRM1885C1H9R8DA01#			
			9.9pF	±0.05pF	GRM1885C1H9R9WA01#			
				±0.1pF	GRM1885C1H9R9BA01#			
				±0.25pF	GRM1885C1H9R9CA01#			
				±0.5pF	GRM1885C1H9R9DA01#			
			10pF	±5%	GRM1885C1H100JA01#			
			12pF	±5%	GRM1885C1H120JA01#			
			15pF	±5%	GRM1885C1H150JA01#			
			18pF	±5%	GRM1885C1H180JA01#			
			22pF	±5%	GRM1885C1H220JA01#			
			27pF	±5%	GRM1885C1H270JA01#			
			33pF	±5%	GRM1885C1H330JA01#			
			39pF	±5%	GRM1885C1H390JA01#			
			47pF	±5%	GRM1885C1H470JA01#			
			56pF	±5%	GRM1885C1H560JA01#			
			68pF	±5%	GRM1885C1H680JA01#			
			82pF	±5%	GRM1885C1H820JA01#			
			100pF	±5%	GRM1885C1H101JA01#			
			120pF	±5%	GRM1885C1H121JA01#			
			150pF	±5%	GRM1885C1H151JA01#			
			180pF	±5%	GRM1885C1H181JA01#			
			220pF	±5%	GRM1885C1H221JA01#			
			270pF	±5%	GRM1885C1H271JA01#			
			330pF	±5%	GRM1885C1H331JA01#			
			390pF	±5%	GRM1885C1H391JA01#			
			470pF	±5%	GRM1885C1H471JA01#			
			560pF	±5%	GRM1885C1H561JA01#			
			680pF	±5%	GRM1885C1H681JA01#			
			820pF	±5%	GRM1885C1H821JA01#			
			1000pF	±5%	GRM1885C1H102JA01#			
			1200pF	±5%	GRM1885C1H122JA01#			
			1500pF	±5%	GRM1885C1H152JA01#			
			1800pF	±5%	GRM1885C1H182JA01#			
			2200pF	±5%	GRM1885C1H222JA01#			
			2700pF	±5%	GRM1885C1H272JA01#			
			3300pF	±5%	GRM1885C1H332JA01#			
			3900pF	±5%	GRM1885C1H392JA01#			
			0.9mm	50Vdc	CK	0.5pF	±0.05pF	GRM1884C1HR50WA01#
							±0.1pF	GRM1884C1HR50BA01#
						0.6pF	±0.05pF	GRM1884C1HR60WA01#
							±0.1pF	GRM1884C1HR60BA01#
0.7pF	±0.05pF	GRM1884C1HR70WA01#						
	±0.1pF	GRM1884C1HR70BA01#						
0.8pF	±0.05pF	GRM1884C1HR80WA01#						
	±0.1pF	GRM1884C1HR80BA01#						
0.9pF	±0.05pF	GRM1884C1HR90WA01#						
	±0.1pF	GRM1884C1HR90BA01#						
1.0pF	±0.05pF	GRM1884C1H1R0WA01#						
	±0.1pF	GRM1884C1H1R0BA01#						
	±0.25pF	GRM1884C1H1R0CA01#						
1.1pF	±0.05pF	GRM1884C1H1R1WA01#						
	±0.1pF	GRM1884C1H1R1BA01#						
	±0.25pF	GRM1884C1H1R1CA01#						

T max.	Rated Voltage	TC Code	Cap.	Tol.	Part Number
0.9mm	50Vdc	CK	1.2pF	±0.05pF	GRM1884C1H1R2WA01#
				±0.1pF	GRM1884C1H1R2BA01#
				±0.25pF	GRM1884C1H1R2CA01#
			1.3pF	±0.05pF	GRM1884C1H1R3WA01#
				±0.1pF	GRM1884C1H1R3BA01#
				±0.25pF	GRM1884C1H1R3CA01#
			1.4pF	±0.05pF	GRM1884C1H1R4WA01#
				±0.1pF	GRM1884C1H1R4BA01#
				±0.25pF	GRM1884C1H1R4CA01#
			1.5pF	±0.05pF	GRM1884C1H1R5WA01#
				±0.1pF	GRM1884C1H1R5BA01#
				±0.25pF	GRM1884C1H1R5CA01#
			1.6pF	±0.05pF	GRM1884C1H1R6WA01#
				±0.1pF	GRM1884C1H1R6BA01#
				±0.25pF	GRM1884C1H1R6CA01#
			1.7pF	±0.05pF	GRM1884C1H1R7WA01#
				±0.1pF	GRM1884C1H1R7BA01#
				±0.25pF	GRM1884C1H1R7CA01#
			1.8pF	±0.05pF	GRM1884C1H1R8WA01#
				±0.1pF	GRM1884C1H1R8BA01#
				±0.25pF	GRM1884C1H1R8CA01#
			1.9pF	±0.05pF	GRM1884C1H1R9WA01#
				±0.1pF	GRM1884C1H1R9BA01#
				±0.25pF	GRM1884C1H1R9CA01#
		2.0pF	±0.05pF	GRM1884C1H2R0WA01#	
			±0.1pF	GRM1884C1H2R0BA01#	
			±0.25pF	GRM1884C1H2R0CA01#	
		2.1pF	±0.05pF	GRM1883C1H2R1WA01#	
				GRM1883C1H2R1BA01#	
				GRM1883C1H2R1CA01#	
		2.2pF	±0.05pF	GRM1883C1H2R2WA01#	
				GRM1883C1H2R2BA01#	
				GRM1883C1H2R2CA01#	
		2.3pF	±0.05pF	GRM1883C1H2R3WA01#	
				GRM1883C1H2R3BA01#	
				GRM1883C1H2R3CA01#	
		2.4pF	±0.05pF	GRM1883C1H2R4WA01#	
				GRM1883C1H2R4BA01#	
				GRM1883C1H2R4CA01#	
		2.5pF	±0.05pF	GRM1883C1H2R5WA01#	
				GRM1883C1H2R5BA01#	
				GRM1883C1H2R5CA01#	
2.6pF	±0.05pF	GRM1883C1H2R6WA01#			
		GRM1883C1H2R6BA01#			
		GRM1883C1H2R6CA01#			
2.7pF	±0.05pF	GRM1883C1H2R7WA01#			
		GRM1883C1H2R7BA01#			
		GRM1883C1H2R7CA01#			
2.8pF	±0.05pF	GRM1883C1H2R8WA01#			
		GRM1883C1H2R8BA01#			
		GRM1883C1H2R8CA01#			
2.9pF	±0.05pF	GRM1883C1H2R9WA01#			
		GRM1883C1H2R9BA01#			
		GRM1883C1H2R9CA01#			
0.9mm	50Vdc	CJ	2.1pF	±0.05pF	GRM1883C1H2R1WA01#
				±0.1pF	GRM1883C1H2R1BA01#
				±0.25pF	GRM1883C1H2R1CA01#
			2.2pF	±0.05pF	GRM1883C1H2R2WA01#
				±0.1pF	GRM1883C1H2R2BA01#
				±0.25pF	GRM1883C1H2R2CA01#
			2.3pF	±0.05pF	GRM1883C1H2R3WA01#
				±0.1pF	GRM1883C1H2R3BA01#
				±0.25pF	GRM1883C1H2R3CA01#
			2.4pF	±0.05pF	GRM1883C1H2R4WA01#
				±0.1pF	GRM1883C1H2R4BA01#
				±0.25pF	GRM1883C1H2R4CA01#
			2.5pF	±0.05pF	GRM1883C1H2R5WA01#
				±0.1pF	GRM1883C1H2R5BA01#
				±0.25pF	GRM1883C1H2R5CA01#
			2.6pF	±0.05pF	GRM1883C1H2R6WA01#
				±0.1pF	GRM1883C1H2R6BA01#
				±0.25pF	GRM1883C1H2R6CA01#
			2.7pF	±0.05pF	GRM1883C1H2R7WA01#
				±0.1pF	GRM1883C1H2R7BA01#
				±0.25pF	GRM1883C1H2R7CA01#
			2.8pF	±0.05pF	GRM1883C1H2R8WA01#
				±0.1pF	GRM1883C1H2R8BA01#
				±0.25pF	GRM1883C1H2R8CA01#
2.9pF	±0.05pF	GRM1883C1H2R9WA01#			
	±0.1pF	GRM1883C1H2R9BA01#			
	±0.25pF	GRM1883C1H2R9CA01#			

Part number # indicates the package specification code.

For General Purpose GRM Series

Capacitor Array GNM Series

Low ESL LLI Series

High-Q Type GJM Series

High Frequency GQM Series

Monolithic Microchip GMA Series

For Bonding GMD Series

Product Information



## GRM Series Temperature Compensating Type Part Number List

(→ ■ 1.6x0.8mm)

T max.	Rated Voltage	TC Code	Cap.	Tol.	Part Number	T max.	Rated Voltage	TC Code	Cap.	Tol.	Part Number					
0.9mm	50Vdc	CJ	3.0pF	±0.05pF	GRM1883C1H3R0WA01#	0.9mm	50Vdc	CH	4.8pF	±0.05pF	GRM1882C1H4R8WA01#					
				±0.1pF	GRM1883C1H3R0BA01#					±0.1pF	GRM1882C1H4R8BA01#					
				±0.25pF	GRM1883C1H3R0CA01#					±0.25pF	GRM1882C1H4R8CA01#					
			3.1pF	±0.05pF	GRM1883C1H3R1WA01#				4.9pF	±0.05pF	GRM1882C1H4R9WA01#					
				±0.1pF	GRM1883C1H3R1BA01#					±0.1pF	GRM1882C1H4R9BA01#					
				±0.25pF	GRM1883C1H3R1CA01#					±0.25pF	GRM1882C1H4R9CA01#					
			3.2pF	±0.05pF	GRM1883C1H3R2WA01#				5.0pF	±0.05pF	GRM1882C1H5R0WA01#					
				±0.1pF	GRM1883C1H3R2BA01#					±0.1pF	GRM1882C1H5R0BA01#					
				±0.25pF	GRM1883C1H3R2CA01#					±0.25pF	GRM1882C1H5R0CA01#					
			3.3pF	±0.05pF	GRM1883C1H3R3WA01#				5.1pF	±0.05pF	GRM1882C1H5R1WA01#					
				±0.1pF	GRM1883C1H3R3BA01#					±0.1pF	GRM1882C1H5R1BA01#					
				±0.25pF	GRM1883C1H3R3CA01#					±0.25pF	GRM1882C1H5R1CA01#					
			3.4pF	±0.05pF	GRM1883C1H3R4WA01#				5.2pF	±0.05pF	GRM1882C1H5R2WA01#					
				±0.1pF	GRM1883C1H3R4BA01#					±0.1pF	GRM1882C1H5R2BA01#					
				±0.25pF	GRM1883C1H3R4CA01#					±0.25pF	GRM1882C1H5R2CA01#					
			3.5pF	±0.05pF	GRM1883C1H3R5WA01#				5.3pF	±0.05pF	GRM1882C1H5R3WA01#					
				±0.1pF	GRM1883C1H3R5BA01#					±0.1pF	GRM1882C1H5R3BA01#					
				±0.25pF	GRM1883C1H3R5CA01#					±0.25pF	GRM1882C1H5R3CA01#					
			3.6pF	±0.05pF	GRM1883C1H3R6WA01#				5.4pF	±0.05pF	GRM1882C1H5R4WA01#					
				±0.1pF	GRM1883C1H3R6BA01#					±0.1pF	GRM1882C1H5R4BA01#					
				±0.25pF	GRM1883C1H3R6CA01#					±0.25pF	GRM1882C1H5R4CA01#					
			3.7pF	±0.05pF	GRM1883C1H3R7WA01#				5.5pF	±0.05pF	GRM1882C1H5R5WA01#					
				±0.1pF	GRM1883C1H3R7BA01#					±0.1pF	GRM1882C1H5R5BA01#					
				±0.25pF	GRM1883C1H3R7CA01#					±0.25pF	GRM1882C1H5R5CA01#					
			3.8pF	±0.05pF	GRM1883C1H3R8WA01#				5.6pF	±0.05pF	GRM1882C1H5R6WA01#					
				±0.1pF	GRM1883C1H3R8BA01#					±0.1pF	GRM1882C1H5R6BA01#					
				±0.25pF	GRM1883C1H3R8CA01#					±0.25pF	GRM1882C1H5R6CA01#					
			3.9pF	±0.05pF	GRM1883C1H3R9WA01#				5.7pF	±0.05pF	GRM1882C1H5R7WA01#					
				±0.1pF	GRM1883C1H3R9BA01#					±0.1pF	GRM1882C1H5R7BA01#					
				±0.25pF	GRM1883C1H3R9CA01#					±0.25pF	GRM1882C1H5R7CA01#					
			CH	50Vdc	4.0pF				±0.05pF	GRM1882C1H4R0WA01#	0.9mm	50Vdc	CH	5.8pF	±0.05pF	GRM1882C1H5R8WA01#
									±0.1pF	GRM1882C1H4R0BA01#					±0.1pF	GRM1882C1H5R8BA01#
									±0.25pF	GRM1882C1H4R0CA01#					±0.25pF	GRM1882C1H5R8CA01#
					4.1pF				±0.05pF	GRM1882C1H4R1WA01#				5.9pF	±0.05pF	GRM1882C1H5R9WA01#
									±0.1pF	GRM1882C1H4R1BA01#					±0.1pF	GRM1882C1H5R9BA01#
									±0.25pF	GRM1882C1H4R1CA01#					±0.25pF	GRM1882C1H5R9CA01#
		4.2pF			±0.05pF			GRM1882C1H4R2WA01#	6.0pF	±0.05pF				GRM1882C1H6R0WA01#		
					±0.1pF			GRM1882C1H4R2BA01#		±0.1pF				GRM1882C1H6R0BA01#		
					±0.25pF			GRM1882C1H4R2CA01#		±0.25pF				GRM1882C1H6R0CA01#		
		4.3pF			±0.05pF			GRM1882C1H4R3WA01#	6.1pF	±0.05pF				GRM1882C1H6R1WA01#		
					±0.1pF			GRM1882C1H4R3BA01#		±0.1pF				GRM1882C1H6R1BA01#		
					±0.25pF			GRM1882C1H4R3CA01#		±0.25pF				GRM1882C1H6R1CA01#		
		4.4pF			±0.05pF			GRM1882C1H4R4WA01#	6.2pF	±0.05pF				GRM1882C1H6R2WA01#		
					±0.1pF			GRM1882C1H4R4BA01#		±0.1pF				GRM1882C1H6R2BA01#		
					±0.25pF			GRM1882C1H4R4CA01#		±0.25pF				GRM1882C1H6R2CA01#		
		4.5pF			±0.05pF			GRM1882C1H4R5WA01#								
					±0.1pF			GRM1882C1H4R5BA01#								
					±0.25pF			GRM1882C1H4R5CA01#								
4.6pF	±0.05pF	GRM1882C1H4R6WA01#														
	±0.1pF	GRM1882C1H4R6BA01#														
	±0.25pF	GRM1882C1H4R6CA01#														
4.7pF	±0.05pF	GRM1882C1H4R7WA01#														
	±0.1pF	GRM1882C1H4R7BA01#														
	±0.25pF	GRM1882C1H4R7CA01#														

Part number # indicates the package specification code.

## GRM Series Temperature Compensating Type Part Number List

(→ ■ 1.6x0.8mm)

T max.	Rated Voltage	TC Code	Cap.	Tol.	Part Number
0.9mm	50Vdc	CH	6.2pF	±0.1pF	GRM1882C1H6R2BA01#
				±0.25pF	GRM1882C1H6R2CA01#
				±0.5pF	GRM1882C1H6R2DA01#
			6.3pF	±0.05pF	GRM1882C1H6R3WA01#
				±0.1pF	GRM1882C1H6R3BA01#
				±0.25pF	GRM1882C1H6R3CA01#
			6.4pF	±0.05pF	GRM1882C1H6R3DA01#
				±0.1pF	GRM1882C1H6R4WA01#
				±0.25pF	GRM1882C1H6R4BA01#
			6.5pF	±0.25pF	GRM1882C1H6R4CA01#
				±0.5pF	GRM1882C1H6R4DA01#
				±0.05pF	GRM1882C1H6R5WA01#
			6.6pF	±0.1pF	GRM1882C1H6R5BA01#
				±0.25pF	GRM1882C1H6R5CA01#
				±0.5pF	GRM1882C1H6R5DA01#
			6.7pF	±0.05pF	GRM1882C1H6R6WA01#
				±0.1pF	GRM1882C1H6R6BA01#
				±0.25pF	GRM1882C1H6R6CA01#
			6.8pF	±0.5pF	GRM1882C1H6R6DA01#
				±0.05pF	GRM1882C1H6R7WA01#
				±0.1pF	GRM1882C1H6R7BA01#
			6.9pF	±0.25pF	GRM1882C1H6R7CA01#
				±0.5pF	GRM1882C1H6R7DA01#
				±0.05pF	GRM1882C1H6R8WA01#
			7.0pF	±0.1pF	GRM1882C1H6R8BA01#
				±0.25pF	GRM1882C1H6R8CA01#
				±0.5pF	GRM1882C1H6R8DA01#
			7.1pF	±0.05pF	GRM1882C1H6R9WA01#
				±0.1pF	GRM1882C1H6R9BA01#
				±0.25pF	GRM1882C1H6R9CA01#
			7.2pF	±0.5pF	GRM1882C1H6R9DA01#
				±0.05pF	GRM1882C1H7R0WA01#
				±0.1pF	GRM1882C1H7R0BA01#
			7.3pF	±0.25pF	GRM1882C1H7R0CA01#
				±0.5pF	GRM1882C1H7R0DA01#
				±0.05pF	GRM1882C1H7R1WA01#
			7.4pF	±0.1pF	GRM1882C1H7R1BA01#
				±0.25pF	GRM1882C1H7R1CA01#
				±0.5pF	GRM1882C1H7R1DA01#
			7.5pF	±0.05pF	GRM1882C1H7R2WA01#
				±0.1pF	GRM1882C1H7R2BA01#
				±0.25pF	GRM1882C1H7R2CA01#
			7.6pF	±0.5pF	GRM1882C1H7R2DA01#
				±0.05pF	GRM1882C1H7R3WA01#
				±0.1pF	GRM1882C1H7R3BA01#
			7.7pF	±0.25pF	GRM1882C1H7R3CA01#
				±0.5pF	GRM1882C1H7R3DA01#
				±0.05pF	GRM1882C1H7R4WA01#
			7.8pF	±0.1pF	GRM1882C1H7R4BA01#
				±0.25pF	GRM1882C1H7R4CA01#
				±0.5pF	GRM1882C1H7R4DA01#
			7.9pF	±0.05pF	GRM1882C1H7R5WA01#
				±0.1pF	GRM1882C1H7R5BA01#
				±0.25pF	GRM1882C1H7R5CA01#
8.0pF	±0.5pF	GRM1882C1H7R5DA01#			
	±0.05pF	GRM1882C1H7R6WA01#			
	±0.1pF	GRM1882C1H7R6BA01#			
8.1pF	±0.25pF	GRM1882C1H7R6CA01#			
	±0.5pF	GRM1882C1H7R6DA01#			
	±0.05pF	GRM1882C1H7R7WA01#			
8.2pF	±0.1pF	GRM1882C1H7R7BA01#			
	±0.25pF	GRM1882C1H7R7CA01#			
	±0.5pF	GRM1882C1H7R7DA01#			
8.3pF	±0.05pF	GRM1882C1H7R8WA01#			
	±0.1pF	GRM1882C1H7R8BA01#			
	±0.25pF	GRM1882C1H7R8CA01#			
8.4pF	±0.5pF	GRM1882C1H7R8DA01#			
	±0.05pF	GRM1882C1H7R9WA01#			
	±0.1pF	GRM1882C1H7R9BA01#			
8.5pF	±0.25pF	GRM1882C1H7R9CA01#			
	±0.5pF	GRM1882C1H7R9DA01#			
	±0.05pF	GRM1882C1H8R0WA01#			
8.6pF	±0.1pF	GRM1882C1H8R0BA01#			
	±0.25pF	GRM1882C1H8R0CA01#			
	±0.5pF	GRM1882C1H8R0DA01#			
8.7pF	±0.05pF	GRM1882C1H8R1WA01#			
	±0.1pF	GRM1882C1H8R1BA01#			
	±0.25pF	GRM1882C1H8R1CA01#			
8.8pF	±0.5pF	GRM1882C1H8R1DA01#			
	±0.05pF	GRM1882C1H8R2WA01#			
	±0.1pF	GRM1882C1H8R2BA01#			
8.9pF	±0.25pF	GRM1882C1H8R2CA01#			
	±0.5pF	GRM1882C1H8R2DA01#			
	±0.05pF	GRM1882C1H8R3WA01#			
9.0pF	±0.1pF	GRM1882C1H8R3BA01#			
	±0.25pF	GRM1882C1H8R3CA01#			
	±0.5pF	GRM1882C1H8R3DA01#			
9.1pF	±0.05pF	GRM1882C1H8R4WA01#			
	±0.1pF	GRM1882C1H8R4BA01#			
	±0.25pF	GRM1882C1H8R4CA01#			
9.2pF	±0.5pF	GRM1882C1H8R4DA01#			
	±0.05pF	GRM1882C1H8R5WA01#			
	±0.1pF	GRM1882C1H8R5BA01#			
9.3pF	±0.25pF	GRM1882C1H8R5CA01#			
	±0.5pF	GRM1882C1H8R5DA01#			
	±0.05pF	GRM1882C1H8R6WA01#			
9.4pF	±0.1pF	GRM1882C1H8R6BA01#			
	±0.25pF	GRM1882C1H8R6CA01#			
	±0.5pF	GRM1882C1H8R6DA01#			
9.5pF	±0.05pF	GRM1882C1H8R7WA01#			
	±0.1pF	GRM1882C1H8R7BA01#			
	±0.25pF	GRM1882C1H8R7CA01#			
9.6pF	±0.5pF	GRM1882C1H8R7DA01#			
	±0.05pF	GRM1882C1H8R8WA01#			
	±0.1pF	GRM1882C1H8R8BA01#			
9.7pF	±0.25pF	GRM1882C1H8R8CA01#			
	±0.5pF	GRM1882C1H8R8DA01#			
	±0.05pF	GRM1882C1H8R9WA01#			
9.8pF	±0.1pF	GRM1882C1H8R9BA01#			
	±0.25pF	GRM1882C1H8R9CA01#			
	±0.5pF	GRM1882C1H8R9DA01#			
9.9pF	±0.05pF	GRM1882C1H8R0WA01#			
	±0.1pF	GRM1882C1H8R0BA01#			
	±0.25pF	GRM1882C1H8R0CA01#			
10.0pF	±0.5pF	GRM1882C1H8R0DA01#			

T max.	Rated Voltage	TC Code	Cap.	Tol.	Part Number
0.9mm	50Vdc	CH	7.5pF	±0.5pF	GRM1882C1H7R5DA01#
				±0.05pF	GRM1882C1H7R6WA01#
				±0.1pF	GRM1882C1H7R6BA01#
			7.6pF	±0.25pF	GRM1882C1H7R6CA01#
				±0.5pF	GRM1882C1H7R6DA01#
				±0.05pF	GRM1882C1H7R7WA01#
			7.7pF	±0.1pF	GRM1882C1H7R7BA01#
				±0.25pF	GRM1882C1H7R7CA01#
				±0.5pF	GRM1882C1H7R7DA01#
			7.8pF	±0.05pF	GRM1882C1H7R8WA01#
				±0.1pF	GRM1882C1H7R8BA01#
				±0.25pF	GRM1882C1H7R8CA01#
			7.9pF	±0.5pF	GRM1882C1H7R8DA01#
				±0.05pF	GRM1882C1H7R9WA01#
				±0.1pF	GRM1882C1H7R9BA01#
			8.0pF	±0.25pF	GRM1882C1H7R9CA01#
				±0.5pF	GRM1882C1H7R9DA01#
				±0.05pF	GRM1882C1H8R0WA01#
			8.1pF	±0.1pF	GRM1882C1H8R0BA01#
				±0.25pF	GRM1882C1H8R0CA01#
				±0.5pF	GRM1882C1H8R0DA01#
			8.2pF	±0.05pF	GRM1882C1H8R1WA01#
				±0.1pF	GRM1882C1H8R1BA01#
				±0.25pF	GRM1882C1H8R1CA01#
			8.3pF	±0.5pF	GRM1882C1H8R1DA01#
				±0.05pF	GRM1882C1H8R2WA01#
				±0.1pF	GRM1882C1H8R2BA01#
			8.4pF	±0.25pF	GRM1882C1H8R2CA01#
				±0.5pF	GRM1882C1H8R2DA01#
				±0.05pF	GRM1882C1H8R3WA01#
			8.5pF	±0.1pF	GRM1882C1H8R3BA01#
				±0.25pF	GRM1882C1H8R3CA01#
				±0.5pF	GRM1882C1H8R3DA01#
			8.6pF	±0.05pF	GRM1882C1H8R4WA01#
				±0.1pF	GRM1882C1H8R4BA01#
				±0.25pF	GRM1882C1H8R4CA01#
			8.7pF	±0.5pF	GRM1882C1H8R4DA01#
				±0.05pF	GRM1882C1H8R5WA01#
				±0.1pF	GRM1882C1H8R5BA01#
			8.8pF	±0.25pF	GRM1882C1H8R5CA01#
				±0.5pF	GRM1882C1H8R5DA01#
				±0.05pF	GRM1882C1H8R6WA01#
			8.9pF	±0.1pF	GRM1882C1H8R6BA01#
				±0.25pF	GRM1882C1H8R6CA01#
				±0.5pF	GRM1882C1H8R6DA01#
			9.0pF	±0.05pF	GRM1882C1H8R7WA01#
				±0.1pF	GRM1882C1H8R7BA01#
				±0.25pF	GRM1882C1H8R7CA01#
			9.1pF	±0.5pF	GRM1882C1H8R7DA01#
				±0.05pF	GRM1882C1H8R8WA01#
				±0.1pF	GRM1882C1H8R8BA01#
			9.2pF	±0.25pF	GRM1882C1H8R8CA01#
				±0.5pF	GRM1882C1H8R8DA01#
				±0.05pF	GRM1882C1H8R9WA01#
9.3pF	±0.1pF	GRM1882C1H8R9BA01#			
	±0.25pF	GRM1882C1H8R9CA01#			
	±0.5pF	GRM1882C1H8R9DA01#			
9.4pF	±0.05pF	GRM1882C1H8R0WA01#			
	±0.1pF	GRM1882C1H8R0BA01#			
	±0.25pF	GRM1882C1H8R0CA01#			
9.5pF	±0.5pF	GRM1882C1H8R0DA01#			

Part number # indicates the package specification code.

For General Purpose GRM Series  
 Capacitor Array GNM Series  
 Low ESL LLI Series  
 High-Q Type GJM Series  
 High Frequency GQM Series  
 Monolithic Microchip GMA Series  
 For Bonding GMD Series  
 Product Information

## GRM Series Temperature Compensating Type Part Number List

(→ ■ 1.6x0.8mm)

T max.	Rated Voltage	TC Code	Cap.	Tol.	Part Number	T max.	Rated Voltage	TC Code	Cap.	Tol.	Part Number
0.9mm	50Vdc	CH	8.9pF	±0.1pF	GRM1882C1H8R9BA01#	0.9mm	50Vdc	CH	82pF	±5%	GRM1882C1H820JA01#
				±0.25pF	GRM1882C1H8R9CA01#				100pF	±5%	GRM1882C1H101JA01#
				±0.5pF	GRM1882C1H8R9DA01#				120pF	±5%	GRM1882C1H121JA01#
			9.0pF	±0.05pF	GRM1882C1H9R0WA01#				150pF	±5%	GRM1882C1H151JA01#
				±0.1pF	GRM1882C1H9R0BA01#				180pF	±5%	GRM1882C1H181JA01#
				±0.25pF	GRM1882C1H9R0CA01#				220pF	±5%	GRM1882C1H221JA01#
			9.1pF	±0.05pF	GRM1882C1H9R1WA01#				270pF	±5%	GRM1882C1H271JA01#
				±0.1pF	GRM1882C1H9R1BA01#				330pF	±5%	GRM1882C1H331JA01#
				±0.25pF	GRM1882C1H9R1CA01#				390pF	±5%	GRM1882C1H391JA01#
				±0.5pF	GRM1882C1H9R1DA01#				470pF	±5%	GRM1882C1H471JA01#
			9.2pF	±0.05pF	GRM1882C1H9R2WA01#				560pF	±5%	GRM1882C1H561JA01#
				±0.1pF	GRM1882C1H9R2BA01#				680pF	±5%	GRM1882C1H681JA01#
				±0.25pF	GRM1882C1H9R2CA01#				820pF	±5%	GRM1882C1H821JA01#
				±0.5pF	GRM1882C1H9R2DA01#				1000pF	±5%	GRM1882C1H102JA01#
			9.3pF	±0.05pF	GRM1882C1H9R3WA01#				1200pF	±5%	GRM1882C1H122JA01#
				±0.1pF	GRM1882C1H9R3BA01#				1500pF	±5%	GRM1882C1H152JA01#
				±0.25pF	GRM1882C1H9R3CA01#				1800pF	±5%	GRM1882C1H182JA01#
				±0.5pF	GRM1882C1H9R3DA01#				2200pF	±5%	GRM1882C1H222JA01#
			9.4pF	±0.05pF	GRM1882C1H9R4WA01#				2700pF	±5%	GRM1882C1H272JA01#
				±0.1pF	GRM1882C1H9R4BA01#				3300pF	±5%	GRM1882C1H332JA01#
				±0.25pF	GRM1882C1H9R4CA01#				3900pF	±5%	GRM1882C1H392JA01#
				±0.5pF	GRM1882C1H9R4DA01#				1200pF	±5%	GRM1881X1H122JA01#
			9.5pF	±0.05pF	GRM1882C1H9R5WA01#				1500pF	±5%	GRM1881X1H152JA01#
				±0.1pF	GRM1882C1H9R5BA01#				1800pF	±5%	GRM1881X1H182JA01#
				±0.25pF	GRM1882C1H9R5CA01#				2200pF	±5%	GRM1881X1H222JA01#
				±0.5pF	GRM1882C1H9R5DA01#				2700pF	±5%	GRM1881X1H272JA01#
			9.6pF	±0.05pF	GRM1882C1H9R6WA01#				3300pF	±5%	GRM1881X1H332JA01#
				±0.1pF	GRM1882C1H9R6BA01#				3900pF	±5%	GRM1881X1H392JA01#
				±0.25pF	GRM1882C1H9R6CA01#				4700pF	±5%	GRM1881X1H472JA01#
				±0.5pF	GRM1882C1H9R6DA01#				5600pF	±5%	GRM1881X1H562JA01#
			9.7pF	±0.05pF	GRM1882C1H9R7WA01#				6800pF	±5%	GRM1881X1H682JA01#
				±0.1pF	GRM1882C1H9R7BA01#				8200pF	±5%	GRM1881X1H822JA01#
				±0.25pF	GRM1882C1H9R7CA01#				10000pF	±5%	GRM1881X1H103JA01#
				±0.5pF	GRM1882C1H9R7DA01#				1200pF	±5%	GRM1887U1H122JA01#
			9.8pF	±0.05pF	GRM1882C1H9R8WA01#				1500pF	±5%	GRM1887U1H152JA01#
				±0.1pF	GRM1882C1H9R8BA01#				1800pF	±5%	GRM1887U1H182JA01#
				±0.25pF	GRM1882C1H9R8CA01#				2200pF	±5%	GRM1887U1H222JA01#
				±0.5pF	GRM1882C1H9R8DA01#				2700pF	±5%	GRM1887U1H272JA01#
			9.9pF	±0.05pF	GRM1882C1H9R9WA01#				3300pF	±5%	GRM1887U1H332JA01#
				±0.1pF	GRM1882C1H9R9BA01#				3900pF	±5%	GRM1887U1H392JA01#
				±0.25pF	GRM1882C1H9R9CA01#				4700pF	±5%	GRM1887U1H472JA01#
				±0.5pF	GRM1882C1H9R9DA01#				5600pF	±5%	GRM1887U1H562JA01#
			10pF	±5%	GRM1882C1H100JA01#				6800pF	±5%	GRM1887U1H682JA01#
			12pF	±5%	GRM1882C1H120JA01#				8200pF	±5%	GRM1887U1H822JA01#
			15pF	±5%	GRM1882C1H150JA01#				10000pF	±5%	GRM1887U1H103JA01#
			18pF	±5%	GRM1882C1H180JA01#				1000pF	±5%	GRM1883U1H102JA01#
			22pF	±5%	GRM1882C1H220JA01#				1200pF	±5%	GRM1883U1H122JA01#
			27pF	±5%	GRM1882C1H270JA01#				1500pF	±5%	GRM1883U1H152JA01#
33pF	±5%	GRM1882C1H330JA01#	1800pF	±5%	GRM1883U1H182JA01#						
39pF	±5%	GRM1882C1H390JA01#	2200pF	±5%	GRM1883U1H222JA01#						
47pF	±5%	GRM1882C1H470JA01#	2700pF	±5%	GRM1883U1H272JA01#						
56pF	±5%	GRM1882C1H560JA01#	3300pF	±5%	GRM1883U1H332JA01#						
68pF	±5%	GRM1882C1H680JA01#	3900pF	±5%	GRM1883U1H392JA01#						
								SL	4700pF	±5%	GRM1883U1H472JA01#
								SL	5600pF	±5%	GRM1883U1H562JA01#
								SL	6800pF	±5%	GRM1883U1H682JA01#
								SL	8200pF	±5%	GRM1883U1H822JA01#
								SL	10000pF	±5%	GRM1883U1H103JA01#
								U2J	1200pF	±5%	GRM1887U1H122JA01#
								U2J	1500pF	±5%	GRM1887U1H152JA01#
								U2J	1800pF	±5%	GRM1887U1H182JA01#
								U2J	2200pF	±5%	GRM1887U1H222JA01#
								U2J	2700pF	±5%	GRM1887U1H272JA01#
								U2J	3300pF	±5%	GRM1887U1H332JA01#
								U2J	3900pF	±5%	GRM1887U1H392JA01#
								U2J	4700pF	±5%	GRM1887U1H472JA01#
								U2J	5600pF	±5%	GRM1887U1H562JA01#
								U2J	6800pF	±5%	GRM1887U1H682JA01#
								U2J	8200pF	±5%	GRM1887U1H822JA01#
								U2J	10000pF	±5%	GRM1887U1H103JA01#
								UJ	1000pF	±5%	GRM1883U1H102JA01#
								UJ	1200pF	±5%	GRM1883U1H122JA01#
								UJ	1500pF	±5%	GRM1883U1H152JA01#
								UJ	1800pF	±5%	GRM1883U1H182JA01#
								UJ	2200pF	±5%	GRM1883U1H222JA01#
								UJ	2700pF	±5%	GRM1883U1H272JA01#
								UJ	3300pF	±5%	GRM1883U1H332JA01#
								UJ	3900pF	±5%	GRM1883U1H392JA01#
								UJ	4700pF	±5%	GRM1883U1H472JA01#

Part number # indicates the package specification code.

For General Purpose  
GRM Series

Capacitor Array  
GNM Series

Low ESL  
LL□ Series

High-Q Type  
GJM Series

High Frequency  
GQM Series

Monolithic Microchip  
GMA Series

For Bonding  
GMD Series

Product Information

## GRM Series Temperature Compensating Type Part Number List

(→ ■ 1.6x0.8mm)

T max.	Rated Voltage	TC Code	Cap.	Tol.	Part Number
0.9mm	50Vdc	UJ	5600pF	±5%	GRM1883U1H562JA01#
			6800pF	±5%	GRM1883U1H682JA01#
			8200pF	±5%	GRM1883U1H822JA01#
			10000pF	±5%	GRM1883U1H103JA01#
	10Vdc	SL	12000pF	±5%	GRM1881X1A123JA01#
			15000pF	±5%	GRM1881X1A153JA01#
			18000pF	±5%	GRM1881X1A183JA01#
		U2J	22000pF	±5%	GRM1881X1A223JA01#
			12000pF	±5%	GRM1887U1A123JA01#
			15000pF	±5%	GRM1887U1A153JA01#
		UJ	18000pF	±5%	GRM1887U1A183JA01#
			22000pF	±5%	GRM1887U1A223JA01#
			12000pF	±5%	GRM1883U1A123JA01#
			15000pF	±5%	GRM1883U1A153JA01#
			18000pF	±5%	GRM1883U1A183JA01#
			22000pF	±5%	GRM1883U1A223JA01#

T max.	Rated Voltage	TC Code	Cap.	Tol.	Part Number	
0.7mm	100Vdc	CH	1500pF	±5%	GRM2162C2A152JA01#	
			1800pF	±5%	GRM2162C2A182JA01#	
			2200pF	±5%	GRM2162C2A222JA01#	
			2700pF	±5%	GRM2162C2A272JA01#	
			3300pF	±5%	GRM2162C2A332JA01#	
			1200pF	±5%	GRM2165C1H122JA01#	
		50Vdc	C0G	1500pF	±5%	GRM2165C1H152JA01#
				1800pF	±5%	GRM2165C1H182JA01#
				2200pF	±5%	GRM2165C1H222JA01#
				2700pF	±5%	GRM2165C1H272JA01#
				3300pF	±5%	GRM2165C1H332JA01#
				3900pF	±5%	GRM2165C1H392JA01#
	50Vdc	CH	4700pF	±5%	GRM2165C1H472JA01#	
			1200pF	±5%	GRM2162C1H122JA01#	
			1500pF	±5%	GRM2162C1H152JA01#	
			1800pF	±5%	GRM2162C1H182JA01#	
			2200pF	±5%	GRM2162C1H222JA01#	
			2700pF	±5%	GRM2162C1H272JA01#	
		SL	3300pF	±5%	GRM2162C1H332JA01#	
			3900pF	±5%	GRM2162C1H392JA01#	
			4700pF	±5%	GRM2162C1H472JA01#	
			12000pF	±5%	GRM2161X1H123JA01#	
			15000pF	±5%	GRM2161X1H153JA01#	
			18000pF	±5%	GRM2161X1H183JA01#	
U2J	UJ	12000pF	±5%	GRM2167U1H123JA01#		
		15000pF	±5%	GRM2167U1H153JA01#		
		18000pF	±5%	GRM2167U1H183JA01#		
	UJ	10000pF	±5%	GRM2163U1H103JA01#		
		12000pF	±5%	GRM2163U1H123JA01#		
		15000pF	±5%	GRM2163U1H153JA01#		
0.95mm	50Vdc	C0G	5600pF	±5%	GRM2195C1H562JA01#	
			6800pF	±5%	GRM2195C1H682JA01#	
			8200pF	±5%	GRM2195C1H822JA01#	
			10000pF	±5%	GRM2195C1H103JA01#	
			12000pF	±5%	GRM2195C1H123JA01#	
			15000pF	±5%	GRM2195C1H153JA01#	
	50Vdc	CH	5600pF	±5%	GRM2192C1H562JA01#	
			6800pF	±5%	GRM2192C1H682JA01#	
			8200pF	±5%	GRM2192C1H822JA01#	
			10000pF	±5%	GRM2192C1H103JA01#	
			12000pF	±5%	GRM2192C1H123JA01#	
			15000pF	±5%	GRM2192C1H153JA01#	
50Vdc	SL	22000pF	±5%	GRM2191X1H223JA01#		
		27000pF	±5%	GRM2191X1H273JA01#		
		22000pF	±5%	GRM2197U1H223JA01#		
	U2J	27000pF	±5%	GRM2197U1H273JA01#		
		22000pF	±5%	GRM2193U1H223JA01#		
		27000pF	±5%	GRM2193U1H273JA01#		
1mm	50Vdc	SL	56000pF	±5%	GRM2191X1A563JA01#	
			56000pF	±5%	GRM2197U1A563JA01#	
			56000pF	±5%	GRM2193U1A563JA01#	
	50Vdc	U2J	33000pF	±5%	GRM21A1X1H333JA39#	
			33000pF	±5%	GRM21A7U1H333JA39#	

■ 2.0x1.25mm

T max.	Rated Voltage	TC Code	Cap.	Tol.	Part Number	
0.7mm	100Vdc	C0G	100pF	±5%	GRM2165C2A101JA01#	
			120pF	±5%	GRM2165C2A121JA01#	
			150pF	±5%	GRM2165C2A151JA01#	
			180pF	±5%	GRM2165C2A181JA01#	
			220pF	±5%	GRM2165C2A221JA01#	
			270pF	±5%	GRM2165C2A271JA01#	
			330pF	±5%	GRM2165C2A331JA01#	
			390pF	±5%	GRM2165C2A391JA01#	
			470pF	±5%	GRM2165C2A471JA01#	
			560pF	±5%	GRM2165C2A561JA01#	
			680pF	±5%	GRM2165C2A681JA01#	
			820pF	±5%	GRM2165C2A821JA01#	
			1000pF	±5%	GRM2165C2A102JA01#	
			1200pF	±5%	GRM2165C2A122JA01#	
			1500pF	±5%	GRM2165C2A152JA01#	
			1800pF	±5%	GRM2165C2A182JA01#	
			2200pF	±5%	GRM2165C2A222JA01#	
			2700pF	±5%	GRM2165C2A272JA01#	
			3300pF	±5%	GRM2165C2A332JA01#	
			CH	100pF	±5%	GRM2162C2A101JA01#
				120pF	±5%	GRM2162C2A121JA01#
				150pF	±5%	GRM2162C2A151JA01#
				180pF	±5%	GRM2162C2A181JA01#
				220pF	±5%	GRM2162C2A221JA01#
				270pF	±5%	GRM2162C2A271JA01#
				330pF	±5%	GRM2162C2A331JA01#
				390pF	±5%	GRM2162C2A391JA01#
				470pF	±5%	GRM2162C2A471JA01#
		560pF		±5%	GRM2162C2A561JA01#	
		680pF		±5%	GRM2162C2A681JA01#	
		820pF		±5%	GRM2162C2A821JA01#	
		1000pF		±5%	GRM2162C2A102JA01#	
		1200pF		±5%	GRM2162C2A122JA01#	

Part number # indicates the package specification code.

For General Purpose GRM Series  
 Capacitor Array GNM Series  
 Low ESL LL Series  
 High-Q Type GJM Series  
 High Frequency GQM Series  
 Monolithic Microchip GMA Series  
 For Bonding GMD Series  
 Product Information



## GRM Series Temperature Compensating Type Part Number List

(→ ■ 2.0x1.25mm)

T max.	Rated Voltage	TC Code	Cap.	Tol.	Part Number	
1mm	50Vdc	UJ	33000pF	±5%	<b>GRM21A3U1H333JA39#</b>	
1.35mm	50Vdc	COG	18000pF	±5%	<b>GRM21B5C1H183JA01#</b>	
			22000pF	±5%	<b>GRM21B5C1H223JA01#</b>	
			CH	18000pF	±5%	<b>GRM21B2C1H183JA01#</b>
				22000pF	±5%	<b>GRM21B2C1H223JA01#</b>
			SL	39000pF	±5%	<b>GRM21B1X1H393JA01#</b>
				47000pF	±5%	<b>GRM21B1X1H473JA01#</b>
		U2J	39000pF	±5%	<b>GRM21B7U1H393JA01#</b>	
			47000pF	±5%	<b>GRM21B7U1H473JA01#</b>	
		UJ	39000pF	±5%	<b>GRM21B3U1H393JA01#</b>	
			47000pF	±5%	<b>GRM21B3U1H473JA01#</b>	
		10Vdc	SL	68000pF	±5%	<b>GRM21B1X1A683JA01#</b>
				82000pF	±5%	<b>GRM21B1X1A823JA01#</b>
	0.1μF			±5%	<b>GRM21B1X1A104JA01#</b>	
	U2J		68000pF	±5%	<b>GRM21B7U1A683JA01#</b>	
			82000pF	±5%	<b>GRM21B7U1A823JA01#</b>	
	0.1μF		±5%	<b>GRM21B7U1A104JA01#</b>		
	UJ	68000pF	±5%	<b>GRM21B3U1A683JA01#</b>		
		82000pF	±5%	<b>GRM21B3U1A823JA01#</b>		
0.1μF		±5%	<b>GRM21B3U1A104JA01#</b>			

■ 3.2x1.6mm

T max.	Rated Voltage	TC Code	Cap.	Tol.	Part Number	
0.95mm	100Vdc	COG	1800pF	±5%	<b>GRM3195C2A182JA01#</b>	
			2200pF	±5%	<b>GRM3195C2A222JA01#</b>	
			2700pF	±5%	<b>GRM3195C2A272JA01#</b>	
			3300pF	±5%	<b>GRM3195C2A332JA01#</b>	
			3900pF	±5%	<b>GRM3195C2A392JA01#</b>	
			4700pF	±5%	<b>GRM3195C2A472JA01#</b>	
			5600pF	±5%	<b>GRM3195C2A562JA01#</b>	
			6800pF	±5%	<b>GRM3195C2A682JA01#</b>	
			8200pF	±5%	<b>GRM3195C2A822JA01#</b>	
			10000pF	±5%	<b>GRM3195C2A103JA01#</b>	
			12000pF	±5%	<b>GRM3195C2A123JA01#</b>	
			15000pF	±5%	<b>GRM3195C2A153JA01#</b>	
			18000pF	±5%	<b>GRM3195C2A183JA01#</b>	
			22000pF	±5%	<b>GRM3195C2A223JA01#</b>	
			CH	1800pF	±5%	<b>GRM3192C2A182JA01#</b>
				2200pF	±5%	<b>GRM3192C2A222JA01#</b>
				2700pF	±5%	<b>GRM3192C2A272JA01#</b>
				3300pF	±5%	<b>GRM3192C2A332JA01#</b>
				3900pF	±5%	<b>GRM3192C2A392JA01#</b>
				4700pF	±5%	<b>GRM3192C2A472JA01#</b>
				5600pF	±5%	<b>GRM3192C2A562JA01#</b>
				6800pF	±5%	<b>GRM3192C2A682JA01#</b>
				8200pF	±5%	<b>GRM3192C2A822JA01#</b>
				10000pF	±5%	<b>GRM3192C2A103JA01#</b>
	12000pF	±5%		<b>GRM3192C2A123JA01#</b>		
	15000pF	±5%		<b>GRM3192C2A153JA01#</b>		
	18000pF	±5%	<b>GRM3192C2A183JA01#</b>			
	22000pF	±5%	<b>GRM3192C2A223JA01#</b>			
	50Vdc	COG	12000pF	±5%	<b>GRM3195C1H123JA01#</b>	

T max.	Rated Voltage	TC Code	Cap.	Tol.	Part Number			
0.95mm	50Vdc	COG	15000pF	±5%	<b>GRM3195C1H153JA01#</b>			
			18000pF	±5%	<b>GRM3195C1H183JA01#</b>			
			22000pF	±5%	<b>GRM3195C1H223JA01#</b>			
			27000pF	±5%	<b>GRM3195C1H273JA01#</b>			
			33000pF	±5%	<b>GRM3195C1H333JA01#</b>			
			39000pF	±5%	<b>GRM3195C1H393JA01#</b>			
			CH	12000pF	±5%	<b>GRM3192C1H123JA01#</b>		
				15000pF	±5%	<b>GRM3192C1H153JA01#</b>		
				18000pF	±5%	<b>GRM3192C1H183JA01#</b>		
				22000pF	±5%	<b>GRM3192C1H223JA01#</b>		
				27000pF	±5%	<b>GRM3192C1H273JA01#</b>		
				33000pF	±5%	<b>GRM3192C1H333JA01#</b>		
		SL	56000pF	±5%	<b>GRM3191X1H563JA01#</b>			
			U2J	56000pF	±5%	<b>GRM3197U1H563JA01#</b>		
			UJ	56000pF	±5%	<b>GRM3193U1H563JA01#</b>		
			1.25mm	50Vdc	COG	47000pF	±5%	<b>GRM31M5C1H473JA01#</b>
						56000pF	±5%	<b>GRM31M5C1H563JA01#</b>
						CH	47000pF	±5%
		56000pF			±5%		<b>GRM31M2C1H563JA01#</b>	
		SL			68000pF		±5%	<b>GRM31M1X1H683JA01#</b>
					82000pF	±5%	<b>GRM31M1X1H823JA01#</b>	
			0.1μF	±5%	<b>GRM31M1X1H104JA01#</b>			
			U2J	68000pF	±5%	<b>GRM31M7U1H683JA01#</b>		
				82000pF	±5%	<b>GRM31M7U1H823JA01#</b>		
0.1μF	±5%			<b>GRM31M7U1H104JA01#</b>				
UJ	68000pF	±5%	<b>GRM31M3U1H683JA01#</b>					
	82000pF	±5%	<b>GRM31M3U1H823JA01#</b>					
	0.1μF	±5%	<b>GRM31M3U1H104JA01#</b>					
1.8mm	50Vdc	COG	68000pF	±5%	<b>GRM31C5C1H683JA01#</b>			
			82000pF	±5%	<b>GRM31C5C1H823JA01#</b>			
			0.1μF	±5%	<b>GRM31C5C1H104JA01#</b>			
			CH	68000pF	±5%	<b>GRM31C2C1H683JA01#</b>		
				82000pF	±5%	<b>GRM31C2C1H823JA01#</b>		
				0.1μF	±5%	<b>GRM31C2C1H104JA01#</b>		

For General Purpose GRM Series  
 Capacitor Array GNM Series  
 Low ESL LLL Series  
 High-Q Type GJM Series  
 High Frequency GQM Series  
 Monolithic Microchip GMA Series  
 For Bonding GMD Series  
 Product Information

Part number # indicates the package specification code.

# GRM Series High Dielectric Constant Type Part Number List

■ 0.4x0.2mm Ultra-compact

T max.	Rated Voltage	TC Code	Cap.	Tol.	Part Number	
0.22mm	10Vdc	X7R	68pF	±10%	GRM022R71A680KA01#	
				±20%	GRM022R71A680MA01#	
			100pF	±10%	GRM022R71A101KA01#	
				±20%	GRM022R71A101MA01#	
			150pF	±10%	GRM022R71A151KA01#	
				±20%	GRM022R71A151MA01#	
			220pF	±10%	GRM022R71A221KA01#	
				±20%	GRM022R71A221MA01#	
			330pF	±10%	GRM022R71A331KA01#	
				±20%	GRM022R71A331MA01#	
			470pF	±10%	GRM022R71A471KA01#	
				±20%	GRM022R71A471MA01#	
			X5R	68pF	±10%	GRM022R61A680KA01#
					±20%	GRM022R61A680MA01#
				100pF	±10%	GRM022R61A101KA01#
					±20%	GRM022R61A101MA01#
				150pF	±10%	GRM022R61A151KA01#
					±20%	GRM022R61A151MA01#
				220pF	±10%	GRM022R61A221KA01#
					±20%	GRM022R61A221MA01#
				330pF	±10%	GRM022R61A331KA01#
					±20%	GRM022R61A331MA01#
				470pF	±10%	GRM022R61A471KA01#
					±20%	GRM022R61A471MA01#
		680pF		±10%	GRM022R61A681KE19#	
				±20%	GRM022R61A681ME19#	
		1000pF		±10%	GRM022R61A102KE19#	
				±20%	GRM022R61A102ME19#	
		1500pF		±10%	GRM022R61A152KE19#	
				±20%	GRM022R61A152ME19#	
		2200pF		±10%	GRM022R61A222KE19#	
				±20%	GRM022R61A222ME19#	
		3300pF		±10%	GRM022R61A332KE19#	
				±20%	GRM022R61A332ME19#	
		4700pF		±10%	GRM022R61A472KE19#	
				±20%	GRM022R61A472ME19#	
		6800pF	±10%	GRM022R61A682KE19#		
			±20%	GRM022R61A682ME19#		
		10000pF	±10%	GRM022R61A103KE19#		
			±20%	GRM022R61A103ME19#		
		B	68pF	±10%	GRM022B11A680KA01#	
				±20%	GRM022B11A680MA01#	
			100pF	±10%	GRM022B11A101KA01#	
				±20%	GRM022B11A101MA01#	
			150pF	±10%	GRM022B11A151KA01#	
				±20%	GRM022B11A151MA01#	
			220pF	±10%	GRM022B11A221KA01#	
				±20%	GRM022B11A221MA01#	
330pF	±10%		GRM022B11A331KA01#			
	±20%		GRM022B11A331MA01#			
470pF	±10%		GRM022B11A471KA01#			
	±20%		GRM022B11A471MA01#			

T max.	Rated Voltage	TC Code	Cap.	Tol.	Part Number		
0.22mm	10Vdc	B	680pF	±10%	GRM022B31A681KE19#		
				±20%	GRM022B31A681ME19#		
			1000pF	±10%	GRM022B31A102KE19#		
				±20%	GRM022B31A102ME19#		
			1500pF	±10%	GRM022B31A152KE19#		
				±20%	GRM022B31A152ME19#		
			2200pF	±10%	GRM022B31A222KE19#		
				±20%	GRM022B31A222ME19#		
			3300pF	±10%	GRM022B31A332KE19#		
				±20%	GRM022B31A332ME19#		
			4700pF	±10%	GRM022B31A472KE19#		
				±20%	GRM022B31A472ME19#		
			6800pF	±10%	GRM022B31A682KE19#		
				±20%	GRM022B31A682ME19#		
			10000pF	±10%	GRM022B31A103KE19#		
				±20%	GRM022B31A103ME19#		
			6.3Vdc	X5R	680pF	±20%	GRM022R60J681ME19#
						±20%	GRM022R60J102ME19#
					1000pF	±20%	GRM022R60J152ME19#
						±20%	GRM022R60J222ME19#
					1500pF	±20%	GRM022R60J332ME19#
						±20%	GRM022R60J472ME19#
					2200pF	±20%	GRM022R60J682ME19#
						±20%	GRM022R60J103ME19#
		3300pF			±20%	GRM022R60J153ME15#	
					±20%	GRM022R60J223KE15#	
		4700pF			±20%	GRM022R60J223ME15#	
					±20%	GRM022R60J333ME15#	
		6800pF			±20%	GRM022R60J473ME15#	
					±20%	GRM022R60J683ME15#	
		10000pF			±20%	GRM022R60J104ME15#	
					±20%	GRM022R60J104ME15#	
		B			680pF	±20%	GRM022B30J681ME19#
						±20%	GRM022B30J102ME19#
					1000pF	±20%	GRM022B30J152ME19#
						±20%	GRM022B30J222ME19#
					1500pF	±20%	GRM022B30J332ME19#
						±20%	GRM022B30J472ME19#
					2200pF	±20%	GRM022B30J682ME19#
						±20%	GRM022B30J103ME19#
			3300pF	±20%	GRM022R60G153KE15#		
				±20%	GRM022R60G223KE15#		
			4700pF	±20%	GRM022R60G333KE15#		
				±20%	GRM022R60G473KE15#		
			6800pF	±20%	GRM022R60G683ME15#		
				±20%	GRM022R60G104ME15#		
			4Vdc	X5R	15000pF	±10%	GRM022R60G153KE15#
						±20%	GRM022R60G223KE15#
22000pF	±10%				GRM022R60G333KE15#		
	±20%				GRM022R60G473KE15#		
33000pF	±10%				GRM022R60G683ME15#		
	±20%				GRM022R60G104ME15#		

Part number # indicates the package specification code.

For General Purpose GRM Series  
 Capacitor Array GNM Series  
 Low ESL LLI Series  
 High-Q Type GJM Series  
 High Frequency GQM Series  
 Monolithic Microchip GMA Series  
 For Bonding GMD Series  
 Product Information

## GRM Series High Dielectric Constant Type Part Number List

■ 0.6×0.3mm Ultra-compact

T max.	Rated Voltage	TC Code	Cap.	Tol.	Part Number
0.33mm	50Vdc	X7R	100pF	±10%	GRM033R71H101KA12#
				±20%	GRM033R71H101MA12#
			150pF	±10%	GRM033R71H151KA12#
				±20%	GRM033R71H151MA12#
			220pF	±10%	GRM033R71H221KA12#
				±20%	GRM033R71H221MA12#
			330pF	±10%	GRM033R71H331KA12#
				±20%	GRM033R71H331MA12#
			470pF	±10%	GRM033R71H471KA12#
				±20%	GRM033R71H471MA12#
			680pF	±10%	GRM033R71H681KA12#
				±20%	GRM033R71H681MA12#
		1000pF	±10%	GRM033R71H102KA12#	
			±20%	GRM033R71H102MA12#	
		1500pF	±10%	GRM033R71H152KA12#	
			±20%	GRM033R71H152MA12#	
		B	100pF	±10%	GRM033B31H101KA12#
				±20%	GRM033B31H101MA12#
			150pF	±10%	GRM033B31H151KA12#
				±20%	GRM033B31H151MA12#
			220pF	±10%	GRM033B31H221KA12#
				±20%	GRM033B31H221MA12#
			330pF	±10%	GRM033B31H331KA12#
				±20%	GRM033B31H331MA12#
	470pF		±10%	GRM033B31H471KA12#	
			±20%	GRM033B31H471MA12#	
	680pF		±10%	GRM033B31H681KA12#	
			±20%	GRM033B31H681MA12#	
	1000pF	±10%	GRM033B31H102KA12#		
		±20%	GRM033B31H102MA12#		
	1500pF	±10%	GRM033B31H152KA12#		
		±20%	GRM033B31H152MA12#		
	25Vdc	X7R	100pF	±10%	GRM033R71E101KA01#
				±10%	GRM033R71E151KA01#
			220pF	±10%	GRM033R71E221KA01#
				±10%	GRM033R71E331KA01#
			470pF	±10%	GRM033R71E471KA01#
				±10%	GRM033R71E681KA01#
			1000pF	±10%	GRM033R71E102KA01#
				±10%	GRM033R71E152KA01#
			2200pF	±10%	GRM033R71E222KA12#
				±20%	GRM033R71E222MA12#
			3300pF	±10%	GRM033R71E332KA12#
				±20%	GRM033R71E332MA12#
		R	100pF	±10%	GRM033R11E101KA01#
				±10%	GRM033R11E151KA01#
			220pF	±10%	GRM033R11E221KA01#
				±10%	GRM033R11E331KA01#
470pF			±10%	GRM033R11E471KA01#	
			±10%	GRM033R11E681KA01#	
1000pF			±10%	GRM033R11E102KA01#	
			±10%	GRM033R11E152KA01#	
2200pF			±10%	GRM033R11E222KA01#	
			±10%	GRM033R11E222MA01#	
3300pF			±10%	GRM033R11E332KA01#	
			±10%	GRM033R11E332MA01#	

T max.	Rated Voltage	TC Code	Cap.	Tol.	Part Number	
0.33mm	25Vdc	X5R	100pF	±10%	GRM033R61E101KA01#	
				±10%	GRM033R61E151KA01#	
			220pF	±10%	GRM033R61E221KA01#	
				±10%	GRM033R61E331KA01#	
			470pF	±10%	GRM033R61E471KA01#	
				±10%	GRM033R61E681KA01#	
			1000pF	±10%	GRM033R61E102KA01#	
				±10%	GRM033R61E103KA12#	
			10000pF	±10%	GRM033R61E103MA12#	
				±20%	GRM033R61E103MA12#	
			B	100pF	±10%	GRM033B11E101KA01#
					±10%	GRM033B11E151KA01#
		220pF		±10%	GRM033B11E221KA01#	
				±10%	GRM033B11E331KA01#	
		470pF		±10%	GRM033B11E471KA01#	
				±10%	GRM033B11E681KA01#	
		1000pF		±10%	GRM033B11E102KA01#	
				±20%	GRM033B11E102MA01#	
		1500pF		±10%	GRM033B11E152KA01#	
				±20%	GRM033B11E152MA01#	
		2200pF		±10%	GRM033B31E222KA12#	
				±20%	GRM033B31E222MA12#	
		3300pF	±10%	GRM033B31E332KA12#		
			±20%	GRM033B31E332MA12#		
	10000pF	±10%	GRM033B31E103KA12#			
		±20%	GRM033B31E103MA12#			
	16Vdc	X7R	2200pF	±10%	GRM033R71C222KA88#	
				±10%	GRM033R71C332KA88#	
			R	2200pF	±10%	GRM033R11C222KA88#
				3300pF	±10%	GRM033R11C332KA88#
		X5R	10000pF	±10%	GRM033R61C103KA12#	
				±20%	GRM033R61C103MA12#	
			0.1μF	±10%	GRM033R61C104KE84#	
				±20%	GRM033R61C104ME84#	
		B	2200pF	±10%	GRM033B31C222KA87#	
				±20%	GRM033B31C222MA87#	
			3300pF	±10%	GRM033B31C332KA87#	
				±20%	GRM033B31C332MA87#	
	10000pF	±10%	GRM033B31C103KA12#			
		±20%	GRM033B31C103MA12#			
	0.1μF	±10%	GRM033B31C104KE84#			
		±20%	GRM033B31C104ME84#			
	10Vdc	X7R	4700pF	±10%	GRM033R71A472KA01#	
				±20%	GRM033R71A472MA01#	
			6800pF	±10%	GRM033R71A682KA01#	
				±20%	GRM033R71A682MA01#	
			10000pF	±10%	GRM033R71A103KA01#	
				±20%	GRM033R71A103MA01#	
R		4700pF	±10%	GRM033R11A472KA01#		
			±20%	GRM033R11A472MA01#		
		6800pF	±10%	GRM033R11A682KA01#		
			±20%	GRM033R11A682MA01#		
		10000pF	±10%	GRM033R11A103KA01#		
			±20%	GRM033R11A103MA01#		
X5R	4700pF	±10%	GRM033R61A472KA01#			

Part number # indicates the package specification code.



## GRM Series High Dielectric Constant Type Part Number List

(→ ■ 0.6x0.3mm)

T max.	Rated Voltage	TC Code	Cap.	Tol.	Part Number		
0.33mm	10Vdc	X5R	4700pF	±20%	GRM033R61A472MA01#		
				±10%	GRM033R61A682KA01#		
			±20%	GRM033R61A682MA01#			
			10000pF	±10%	GRM033R61A103KA01#		
				±20%	GRM033R61A103MA01#		
			12000pF	±10%	GRM033R61A123KE84#		
				±20%	GRM033R61A123ME84#		
			15000pF	±10%	GRM033R61A153KE84#		
				±20%	GRM033R61A153ME84#		
			18000pF	±10%	GRM033R61A183KE84#		
				±20%	GRM033R61A183ME84#		
			22000pF	±10%	GRM033R61A223KE84#		
				±20%	GRM033R61A223ME84#		
			27000pF	±10%	GRM033R61A273KE84#		
				±20%	GRM033R61A273ME84#		
			33000pF	±10%	GRM033R61A333KE84#		
				±20%	GRM033R61A333ME84#		
			39000pF	±10%	GRM033R61A393KE84#		
				±20%	GRM033R61A393ME84#		
			47000pF	±10%	GRM033R61A473KE84#		
				±20%	GRM033R61A473ME84#		
			68000pF	±10%	GRM033R61A683KE84#		
				±20%	GRM033R61A683ME84#		
			0.1μF	±10%	GRM033R61A104KE84#		
				±20%	GRM033R61A104ME84#		
			0.22μF	±20%	GRM033R61A224ME90#	Derating	
			B	4700pF	±10%	GRM033B11A472KA01#	
					±20%	GRM033B11A472MA01#	
				6800pF	±10%	GRM033B11A682KA01#	
					±20%	GRM033B11A682MA01#	
		10000pF		±10%	GRM033B11A103KA01#		
				±20%	GRM033B11A103MA01#		
		12000pF		±10%	GRM033B31A123KE84#		
				±20%	GRM033B31A123ME84#		
		15000pF		±10%	GRM033B31A153KE84#		
				±20%	GRM033B31A153ME84#		
		18000pF		±10%	GRM033B31A183KE84#		
				±20%	GRM033B31A183ME84#		
		22000pF		±10%	GRM033B31A223KE84#		
				±20%	GRM033B31A223ME84#		
		27000pF		±10%	GRM033B31A273KE84#		
				±20%	GRM033B31A273ME84#		
		33000pF		±10%	GRM033B31A333KE84#		
				±20%	GRM033B31A333ME84#		
		39000pF		±10%	GRM033B31A393KE84#		
				±20%	GRM033B31A393ME84#		
		47000pF	±10%	GRM033B31A473KE84#			
			±20%	GRM033B31A473ME84#			
		68000pF	±10%	GRM033B31A683KE84#			
			±20%	GRM033B31A683ME84#			
0.1μF	±10%	GRM033B31A104KE84#					
	±20%	GRM033B31A104ME84#					
6.3Vdc	X7R	4700pF	±10%	GRM033R70J472KA01#			
		6800pF	±10%	GRM033R70J682KA01#			

T max.	Rated Voltage	TC Code	Cap.	Tol.	Part Number		
0.33mm	6.3Vdc	X7R	10000pF	±10%	GRM033R70J103KA01#		
				±10%	GRM033R10J472KA01#		
				±10%	GRM033R10J682KA01#		
			4700pF	±10%	GRM033R10J103KA01#		
				6800pF	±10%	GRM033C80J153KE01#	
					±20%	GRM033C80J153ME01#	
			22000pF	±10%	GRM033C80J223KE01#		
				±20%	GRM033C80J223ME01#		
			33000pF	±10%	GRM033C80J333KE01#		
				±20%	GRM033C80J333ME01#		
		47000pF	±10%	GRM033C80J473KE19#			
			±20%	GRM033C80J473ME19#			
		68000pF	±10%	GRM033C80J683KE84#	Derating		
			±20%	GRM033C80J683ME84#	Derating		
		0.1μF	±10%	GRM033C80J104KE84#	Derating		
			±20%	GRM033C80J104ME84#	Derating		
		0.22μF	±20%	GRM033C80J224ME90#	Derating		
			X5R	10000pF	±10%	GRM033R60J103KA01#	
		15000pF		±10%	GRM033R60J153KE01#		
		±20%		GRM033R60J153ME01#			
		22000pF	±10%	GRM033R60J223KE01#			
			±20%	GRM033R60J223ME01#			
		33000pF	±10%	GRM033R60J333KE01#			
			±20%	GRM033R60J333ME01#			
		47000pF	±10%	GRM033R60J473KE19#			
			±20%	GRM033R60J473ME19#			
		0.22μF	±20%	GRM033R60J224ME90#			
			B	4700pF	±10%	GRM033B10J472KA01#	
		6800pF		±10%	GRM033B10J682KA01#		
		10000pF		±10%	GRM033B10J103KA01#		
		15000pF		±10%	GRM033B10J153KE01#		
		±20%		GRM033B10J153ME01#			
		22000pF		±10%	GRM033B10J223KE01#		
		±20%		GRM033B10J223ME01#			
		33000pF		±10%	GRM033B10J333KE01#		
		±20%		GRM033B10J333ME01#			
		47000pF		±10%	GRM033B30J473KE18#		
		±20%	GRM033B30J473ME18#				
		4Vdc	X6S	0.22μF	±20%	GRM033C80G224ME90#	

■ 1.0x0.5mm

T max.	Rated Voltage	TC Code	Cap.	Tol.	Part Number		
0.22mm	10Vdc	X5R	0.1μF	±10%	GRM152R61A104KE19#	Derating	
				±20%	GRM152R61A104ME19#	Derating	
			0.22μF	±10%	GRM152R61A224KE19#	Derating	
				±20%	GRM152R61A224ME19#	Derating	
				B	0.1μF	±10%	GRM152B31A104KE19#
		±20%	GRM152B31A104ME19#		Derating		
		0.22μF	±10%	GRM152B31A224KE19#	Derating		
			±20%	GRM152B31A224ME19#	Derating		
		6.3Vdc	X6S	0.1μF	±10%	GRM152C80J104KE19#	Derating
					±20%	GRM152C80J104ME19#	Derating

Part number # indicates the package specification code.

For General Purpose GRM Series  
 Capacitor Array GNM Series  
 Low ESL LL Series  
 High-Q Type GJM Series  
 High Frequency GQM Series  
 Monolithic Microchip GMA Series  
 For Bonding GMD Series  
 Product Information

## GRM Series High Dielectric Constant Type Part Number List

(→ ■ 1.0x0.5mm)

T max.	Rated Voltage	TC Code	Cap.	Tol.	Part Number		
0.22mm	6.3Vdc	X6S	0.22μF	±10%	GRM152C80J224KE19#	<b>Derating</b>	
				±20%	GRM152C80J224ME19#	<b>Derating</b>	
			X5R	0.1μF	±10%	GRM152R60J104KE19#	
					±20%	GRM152R60J104ME19#	
				0.22μF	±10%	GRM152R60J224KE19#	
		±20%	GRM152R60J224ME19#				
		0.47μF	±20%	GRM152R60J474ME15#	<b>Derating</b>		
		B	0.1μF	±10%	GRM152B30J104KE19#		
				±20%	GRM152B30J104ME19#		
			0.22μF	±10%	GRM152B30J224KE19#		
	±20%			GRM152B30J224ME19#			
	0.47μF		±20%	GRM152B30J474ME15#	<b>Derating</b>		
	4Vdc	X7T	0.1μF	±10%	GRM152D70G104KE15#	<b>Derating</b>	
				±20%	GRM152D70G104ME15#	<b>Derating</b>	
			0.22μF	±10%	GRM152D70G224KE15#	<b>Derating</b>	
				±20%	GRM152D70G224ME15#	<b>Derating</b>	
			X6S	0.1μF	±10%	GRM152C80G104KE19#	
		±20%			GRM152C80G104ME19#		
		0.22μF		±10%	GRM152C80G224KE19#		
		±20%	GRM152C80G224ME19#				
X6T		0.47μF	±20%	GRM152D80G474ME15#			
2.5Vdc		X7T	0.1μF	±10%	GRM152D70E104KE19#		
	±20%			GRM152D70E104ME19#			
	0.22μF		±10%	GRM152D70E224KE19#			
			±20%	GRM152D70E224ME19#			
0.3mm	50Vdc	X7R	220pF	±10%	GRM15XR71H221KA86#		
			330pF	±10%	GRM15XR71H331KA86#		
			470pF	±10%	GRM15XR71H471KA86#		
			680pF	±10%	GRM15XR71H681KA86#		
			1000pF	±10%	GRM15XR71H102KA86#		
			1500pF	±10%	GRM15XR71H152KA86#		
		R	220pF	±10%	GRM15XR11H221KA86#		
			330pF	±10%	GRM15XR11H331KA86#		
			470pF	±10%	GRM15XR11H471KA86#		
			680pF	±10%	GRM15XR11H681KA86#		
	1000pF		±10%	GRM15XR11H102KA86#			
	1500pF		±10%	GRM15XR11H152KA86#			
	B		220pF	±10%	GRM15XB11H221KA86#		
			±20%	GRM15XB11H221MA86#			
		330pF	±10%	GRM15XB11H331KA86#			
		±20%	GRM15XB11H331MA86#				
		470pF	±10%	GRM15XB11H471KA86#			
		±20%	GRM15XB11H471MA86#				
	680pF	±10%	GRM15XB11H681KA86#				
		±20%	GRM15XB11H681MA86#				
1000pF	±10%	GRM15XB11H102KA86#					
±20%	GRM15XB11H102MA86#						
1500pF	±10%	GRM15XB11H152KA86#					
±20%	GRM15XB11H152MA86#						
25Vdc	X7R	2200pF	±10%	GRM15XR71E222KA86#			
			±20%	GRM15XR71E222MA86#			
	B	2200pF	±10%	GRM15XB11E222KA86#			
			±20%	GRM15XB11E222MA86#			
16Vdc	X7R	3300pF	±10%	GRM15XR71C332KA86#			
			±20%	GRM15XR71C332ME19#			

T max.	Rated Voltage	TC Code	Cap.	Tol.	Part Number		
0.3mm	16Vdc	X7R	3300pF	±20%	GRM15XR71C332MA86#		
			4700pF	±10%	GRM15XR71C472KA86#		
				±20%	GRM15XR71C472MA86#		
			6800pF	±10%	GRM15XR71C682KA86#		
				±20%	GRM15XR71C682MA86#		
			10000pF	±10%	GRM15XR71C103KA86#		
				±20%	GRM15XR71C103MA86#		
			B	3300pF	±10%	GRM15XB11C332KA86#	
					±20%	GRM15XB11C332MA86#	
				4700pF	±10%	GRM15XB11C472KA86#	
	±20%	GRM15XB11C472MA86#					
	6800pF	±10%		GRM15XB11C682KA86#			
		±20%		GRM15XB11C682MA86#			
	10000pF	±10%		GRM15XB11C103KA86#			
		±20%		GRM15XB11C103MA86#			
	10Vdc	X5R		15000pF	±10%	GRM15XR61A153KA86#	
					±20%	GRM15XR61A153MA86#	
			22000pF	±10%	GRM15XR61A223KA86#		
				±20%	GRM15XR61A223MA86#		
			33000pF	±10%	GRM15XR61A333KA86#		
±20%				GRM15XR61A333MA86#			
10Vdc		X5R	1.0μF	±20%	GRM153R61A105ME95#	<b>Derating</b>	
				B	1.0μF	±20%	GRM153B31A105ME95#
		6.3Vdc	X6T	1.0μF	±20%	GRM153D80J105ME95#	<b>Derating</b>
					X5R	1.0μF	±20%
B	1.0μF	±20%	GRM153B30J105ME95#				
		X5R	1.0μF	±20%	GRM153R60G105ME95#		
4Vdc	X6T	1.0μF	±20%	GRM153D80G105ME95#			
			X5R	1.0μF	±20%	GRM153R60G105ME95#	
0.55mm	100Vdc	X7R	220pF	±10%	GRM155R72A221KA01#		
			330pF	±10%	GRM155R72A331KA01#		
			470pF	±10%	GRM155R72A471KA01#		
			680pF	±10%	GRM155R72A681KA01#		
			1000pF	±10%	GRM155R72A102KA01#		
			1500pF	±10%	GRM155R72A152KA01#		
			2200pF	±10%	GRM155R72A222KA01#		
			3300pF	±10%	GRM155R72A332KA01#		
			4700pF	±10%	GRM155R72A472KA01#		
			50Vdc	X7R	220pF	±10%	GRM155R71H221KA01#
	330pF	±10%			GRM155R71H331KA01#		
	470pF	±10%			GRM155R71H471KA01#		
	680pF	±10%			GRM155R71H681KA01#		
	1000pF	±10%			GRM155R71H102KA01#		
	1500pF	±10%			GRM155R71H152KA01#		
	2200pF	±10%			GRM155R71H222KA01#		
	3300pF	±10%			GRM155R71H332KA01#		
	4700pF	±10%			GRM155R71H472KA01#		
	6800pF	±10%			GRM155R71H682KA88#		
	10000pF	X7S	10000pF	±10%	GRM155R71H103KA88#		
±20%				GRM155R71H103ME19#			
15000pF			±10%	GRM155R71H153KA12#			
			±20%	GRM155R71H153ME19#			
22000pF			±10%	GRM155R71H223KA12#			
			±20%	GRM155R71H223ME19#			
0.1μF			±10%	GRM155R71H104KE14#			
			±20%	GRM155R71H104ME14#			
33000pF			±10%	GRM155C71H333KE19#			
				GRM155C71H333ME19#			

Part number # indicates the package specification code.

For General Purpose GRM Series  
 Capacitor Array GNM Series  
 Low ESL LL Series  
 High-Q Type GJM Series  
 High Frequency GQM Series  
 Monolithic Microchip GMA Series  
 For Bonding GMD Series  
 Product Information

## GRM Series High Dielectric Constant Type Part Number List

(→ ■ 1.0x0.5mm)

T max.	Rated Voltage	TC Code	Cap.	Tol.	Part Number	
0.55mm	50Vdc	X7S	47000pF	±10%	GRM155C71H473KE19#	
				±20%	GRM155C71H473ME19#	
			68000pF	±10%	GRM155C71H683KE19#	
				±20%	GRM155C71H683ME19#	
			R	220pF	±10%	GRM155R11H221KA01#
					±20%	GRM155R11H221MA01#
				330pF	±10%	GRM155R11H331KA01#
					±20%	GRM155R11H331MA01#
				470pF	±10%	GRM155R11H471KA01#
					±20%	GRM155R11H471MA01#
				680pF	±10%	GRM155R11H681KA01#
					±20%	GRM155R11H681MA01#
		1000pF		±10%	GRM155R11H102KA01#	
				±20%	GRM155R11H102MA01#	
		1500pF		±10%	GRM155R11H152KA01#	
				±20%	GRM155R11H152MA01#	
		2200pF	±10%	GRM155R11H222KA01#		
			±20%	GRM155R11H222MA01#		
		3300pF	±10%	GRM155R11H332KA01#		
			±20%	GRM155R11H332MA01#		
		4700pF	±10%	GRM155R11H472KA01#		
			±20%	GRM155R11H472MA01#		
		6800pF	±10%	GRM155R11H682KA88#		
			±20%	GRM155R11H682MA88#		
		10000pF	±10%	GRM155R11H103KA88#		
			±20%	GRM155R11H103MA88#		
		X6S	0.1μF	±10%	GRM155C81H104KE14#	
				±20%	GRM155C81H104ME14#	
		X5R	1000pF	±10%	GRM155R61H102KA01#	
				±20%	GRM155R61H102MA01#	
			2200pF	±10%	GRM155R61H222KA01#	
				±20%	GRM155R61H222MA01#	
			4700pF	±10%	GRM155R61H472KA01#	
				±20%	GRM155R61H472MA01#	
			33000pF	±10%	GRM155R61H333KE19#	
				±20%	GRM155R61H333ME19#	
			47000pF	±10%	GRM155R61H473KE19#	
				±20%	GRM155R61H473ME19#	
			68000pF	±10%	GRM155R61H683KE19#	
				±20%	GRM155R61H683ME19#	
		0.1μF	±10%	GRM155R61H104KE14#		
			±20%	GRM155R61H104ME14#		
		B	220pF	±10%	GRM155B11H221KA01#	
				±20%	GRM155B11H221MA01#	
			330pF	±10%	GRM155B11H331KA01#	
				±20%	GRM155B11H331MA01#	
			470pF	±10%	GRM155B11H471KA01#	
				±20%	GRM155B11H471MA01#	
680pF	±10%		GRM155B11H681KA01#			
	±20%		GRM155B11H681MA01#			
1000pF	±10%		GRM155B11H102KA01#			
	±20%		GRM155B11H102MA01#			
1500pF	±10%		GRM155B11H152KA01#			
	±20%		GRM155B11H152MA01#			
2200pF	±10%		GRM155B11H222KA01#			
	±20%		GRM155B11H222MA01#			
3300pF	±10%		GRM155B11H332KA01#			
	±20%		GRM155B11H332MA01#			
4700pF	±10%		GRM155B11H472KA01#			
	±20%		GRM155B11H472MA01#			
6800pF	±10%	GRM155B31H682KA88#				
	±20%	GRM155B31H682MA88#				
10000pF	±10%	GRM155B31H103KA88#				
	±20%	GRM155B31H103MA88#				
15000pF	±10%	GRM155B31H153KA12#				
	±20%	GRM155B31H153MA12#				
22000pF	±10%	GRM155B31H223KA12#				
	±20%	GRM155B31H223MA12#				

T max.	Rated Voltage	TC Code	Cap.	Tol.	Part Number
0.55mm	50Vdc	B	0.1μF	±10%	GRM155B31H104KE14#
				±20%	GRM155B31H104ME14#
			6800pF	±10%	GRM155R71E682KA01#
				±20%	GRM155R71E682MA01#
			10000pF	±10%	GRM155R71E103KA01#
				±20%	GRM155R71E103MA01#
			15000pF	±10%	GRM155R71E153KA61#
				±20%	GRM155R71E153MA61#
			22000pF	±10%	GRM155R71E223KA61#
				±20%	GRM155R71E223MA61#
			33000pF	±10%	GRM155R71E333KA88#
				±20%	GRM155R71E333MA88#
		47000pF	±10%	GRM155R71E473KA88#	
			±20%	GRM155R71E473MA88#	
		0.1μF	±10%	GRM155R71E104KE14#	
			±20%	GRM155R71E104ME14#	
		R	6800pF	±10%	GRM155R11E682KA01#
				±20%	GRM155R11E682MA01#
			10000pF	±10%	GRM155R11E103KA01#
				±20%	GRM155R11E103MA01#
			15000pF	±10%	GRM155R11E153KA61#
				±20%	GRM155R11E153MA61#
			22000pF	±10%	GRM155R11E223KA61#
				±20%	GRM155R11E223MA61#
	33000pF		±10%	GRM155R11E333KA88#	
			±20%	GRM155R11E333MA88#	
	47000pF		±10%	GRM155R11E473KA88#	
			±20%	GRM155R11E473MA88#	
	X6S	68000pF	±10%	GRM155C81E683KA12#	
			±20%	GRM155C81E683MA12#	
	0.1μF	±10%	GRM155C81E104KA12#		
		±20%	GRM155C81E104MA12#		
	X5R	68000pF	±10%	GRM155R61E683KA87#	
			±20%	GRM155R61E683MA87#	
		0.1μF	±10%	GRM155R61E104KA87#	
			±20%	GRM155R61E104MA87#	
		1.0μF	±10%	GRM155R61E105KA12#	
			±20%	GRM155R61E105MA12#	
	B	4700pF	±10%	GRM155B11E472KA01#	
			±20%	GRM155B11E472MA01#	
	6800pF	±10%	GRM155B11E682KA01#		
		±20%	GRM155B11E682MA01#		
	10000pF	±10%	GRM155B11E103KA01#		
		±20%	GRM155B11E103MA01#		
	15000pF	±10%	GRM155B11E153KA61#		
		±20%	GRM155B11E153MA61#		
	22000pF	±10%	GRM155B11E223KA61#		
		±20%	GRM155B11E223MA61#		
33000pF	±10%	GRM155B31E333KA87#			
	±20%	GRM155B31E333MA87#			
47000pF	±10%	GRM155B31E473KA87#			
	±20%	GRM155B31E473MA87#			
68000pF	±10%	GRM155B31E683KA87#			
	±20%	GRM155B31E683MA87#			
0.1μF	±10%	GRM155B31E104KA87#			
	±20%	GRM155B31E104MA87#			
1.0μF	±10%	GRM155B31E105KA12#			
	±20%	GRM155B31E105MA12#			
16Vdc	X7R	33000pF	±10%	GRM155R71C333KA01#	
			±20%	GRM155R71C333MA01#	
		47000pF	±10%	GRM155R71C473KA01#	
			±20%	GRM155R71C473MA01#	
		68000pF	±10%	GRM155R71C683KA88#	
			±20%	GRM155R71C683MA88#	
	0.15μF	±10%	GRM155R71C154KA12#		
		±20%	GRM155R71C154MA12#		
	0.22μF	±10%	GRM155R71C224KA12#		
		±20%	GRM155R71C224MA12#		
	R	33000pF	±10%	GRM155R11C333KA01#	
			±20%	GRM155R11C333MA01#	
47000pF		±10%	GRM155R11C473KA01#		
	±20%	GRM155R11C473MA01#			
X5R	33000pF	±10%	GRM155R61C333KA01#		
		±20%	GRM155R61C333MA01#		
	47000pF	±10%	GRM155R61C473KA01#		
±20%		GRM155R61C473MA01#			
68000pF	±10%	GRM155R61C683KA88#			
	±20%	GRM155R61C683MA88#			

Part number # indicates the package specification code.

For General Purpose GRM Series

Capacitor Array GNM Series

Low ESL LLD Series

High-Q Type GJM Series

High Frequency GQM Series

Monolithic Microchip GMA Series

For Bonding GMD Series

Product Information

## GRM Series High Dielectric Constant Type Part Number List

(→ ■ 1.0x0.5mm)

T max.	Rated Voltage	TC Code	Cap.	Tol.	Part Number			
0.55mm	16Vdc	X5R	1.0μF	±10%	GRM155R61C105KA12#			
				±20%	GRM155R61C105MA12#			
			B	33000pF	±10%	GRM155B11C333KA01#		
				47000pF	±10%	GRM155B11C473KA01#		
				68000pF	±10%	GRM155B31C683KA87#		
				1.0μF	±10%	GRM155B31C105KA12#		
			±20%	GRM155B31C105MA12#				
		10Vdc	X7R	68000pF	±10%	GRM155R71A683KA01#		
					±20%	GRM155R71A683MA01#		
				R	68000pF	±10%	GRM155R11A683KA01#	
						±20%	GRM155R11A683MA01#	
			X6S	1.0μF	±10%	GRM155C81A105KA12#		
	±20%				GRM155C81A105MA12#			
	X5R			0.15μF	±10%	GRM155R61A154KE19#		
					±20%	GRM155R61A154ME19#		
			0.22μF	±10%	GRM155R61A224KE19#			
				±20%	GRM155R61A224ME19#			
			0.33μF	±10%	GRM155R61A334KE15#			
				±20%	GRM155R61A334ME15#			
	0.47μF		±10%	GRM155R61A474KE15#				
			±20%	GRM155R61A474ME15#				
	0.68μF		±10%	GRM155R61A684KE15#				
			±20%	GRM155R61A684ME15#				
	2.2μF		±10%	GRM155R61A225KE95#	Derating			
			±20%	GRM155R61A225ME95#	Derating			
	B	0.15μF	±10%	GRM155B31A154KE18#				
			±20%	GRM155B31A154ME18#				
		0.22μF	±10%	GRM155B31A224KE18#				
			±20%	GRM155B31A224ME18#				
		0.33μF	±10%	GRM155B31A334KE14#				
			±20%	GRM155B31A334ME14#				
		0.47μF	±10%	GRM155B31A474KE14#				
			±20%	GRM155B31A474ME14#				
		0.68μF	±10%	GRM155B31A684KE15#				
			±20%	GRM155B31A684ME15#				
		2.2μF	±10%	GRM155B31A225KE95#	Derating			
			±20%	GRM155B31A225ME95#	Derating			
	6.3Vdc	X7R	1.0μF	±10%	GRM155R70J105KA12#	Derating		
				±20%	GRM155R70J105MA12#	Derating		
			X6S	0.15μF	±10%	GRM155C80J154KE01#		
					±20%	GRM155C80J154ME01#		
				0.22μF	±10%	GRM155C80J224KE01#		
					±20%	GRM155C80J224ME01#		
		0.33μF		±10%	GRM155C80J334KE01#			
				±20%	GRM155C80J334ME01#			
		0.47μF	±10%	GRM155C80J474KE19#				
			±20%	GRM155C80J474ME19#				
		2.2μF	±10%	GRM155C80J225KE95#	Derating			
±20%			GRM155C80J225ME95#	Derating				
X5R		0.15μF	±10%	GRM155R60J154KE01#				
			±20%	GRM155R60J154ME01#				
		0.22μF	±10%	GRM155R60J224KE01#				
			±20%	GRM155R60J224ME01#				
		0.33μF	±10%	GRM155R60J334KE01#				
			±10%	GRM155R60J334ME01#				

T max.	Rated Voltage	TC Code	Cap.	Tol.	Part Number			
0.55mm	6.3Vdc	X5R	0.33μF	±20%	GRM155R60J334ME01#			
				±10%	GRM155R60J474KE19#			
				±20%	GRM155R60J474ME19#			
			0.68μF	±10%	GRM155R60J684KE19#			
				±20%	GRM155R60J684ME19#			
			2.2μF	±10%	GRM155R60J225KE95#			
		±20%		GRM155R60J225ME95#				
		B	0.15μF	±10%	GRM155B10J154KE01#			
				±20%	GRM155B10J154ME01#			
			0.22μF	±10%	GRM155B10J224KE01#			
				±20%	GRM155B10J224ME01#			
			0.33μF	±10%	GRM155B10J334KE01#			
				±20%	GRM155B10J334ME01#			
		4Vdc	X7R	1.0μF	±10%	GRM155R70G105KA12#		
					±20%	GRM155R70G105MA12#		
				X6S	0.15μF	±10%	GRM155C80G154KE01#	
			±20%			GRM155C80G154ME01#		
			0.22μF		±10%	GRM155C80G224KE01#		
	±20%			GRM155C80G224ME01#				
	X6T	2.2μF	±10%	GRM155D80G225KE95#				
			±20%	GRM155D80G225ME95#				
		0.33μF	±10%	GRM155C80G334KE01#				
			±20%	GRM155C80G334ME01#				
		0.47μF	±10%	GRM155C80G474KE01#				
			±20%	GRM155C80G474ME01#				
	0.6mm	6.3Vdc	X5R	4.7μF	±20%	GRM155R60J475ME47#	Derating	
					±10%	GRM155B30J475ME47#	Derating	
			4Vdc	X5R	4.7μF	±20%	GRM155R60G475ME47#	
						±10%	GRM155B30G475ME47#	
		2.5Vdc	X6T	4.7μF	±20%	GRM155D80E475ME47#	Derating	
		4Vdc	X5R	10μF	±20%	GRM155R60G106ME44#		
		2.5Vdc	X5R	10μF	±20%	GRM155R60E106ME16#		

■ 1.6x0.8mm

T max.	Rated Voltage	TC Code	Cap.	Tol.	Part Number		
0.5mm	25Vdc	X5R	1.0μF	±10%	GRM185R61E105KA12#	Derating	
				±20%	GRM185R61E105MA12#	Derating	
			B	1.0μF	±10%	GRM185B31E105KA12#	Derating
		±20%			GRM185B31E105MA12#	Derating	
		16Vdc	X5R	1.0μF	±10%	GRM185R61C105KE44#	
					±20%	GRM185R61C105ME44#	
	B			1.0μF	±10%	GRM185B31C105KE43#	
			±20%		GRM185B31C105ME43#		
	100Vdc		X7R	220pF	±10%	GRM188R72A221KA01#	
					±10%	GRM188R72A331KA01#	
		470pF		±10%	GRM188R72A471KA01#		

Part number # indicates the package specification code.



## GRM Series High Dielectric Constant Type Part Number List

(→ ■ 1.6x0.8mm)

T max.	Rated Voltage	TC Code	Cap.	Tol.	Part Number			
0.9mm	100Vdc	X7R	680pF	±10%	GRM188R72A681KA01#			
			1000pF	±10%	GRM188R72A102KA01#			
			1500pF	±10%	GRM188R72A152KA01#			
			2200pF	±10%	GRM188R72A222KA01#			
			3300pF	±10%	GRM188R72A332KA01#			
			4700pF	±10%	GRM188R72A472KA01#			
			6800pF	±10%	GRM188R72A682KA01#			
			10000pF	±10%	GRM188R72A103KA01#			
			15000pF	±10%	GRM188R72A153KAC4#			
				±20%	GRM188R72A153MAC4#			
			22000pF	±10%	GRM188R72A223KAC4#			
				±20%	GRM188R72A223MAC4#			
			0.1μF	±10%	GRM188R72A104KA35#			
			50Vdc	X7R	X7R	220pF	±10%	GRM188R71H221KA01#
						330pF	±10%	GRM188R71H331KA01#
	470pF	±10%				GRM188R71H471KA01#		
	680pF	±10%				GRM188R71H681KA01#		
	1000pF	±10%				GRM188R71H102KA01#		
	1500pF	±10%				GRM188R71H152KA01#		
	2200pF	±10%				GRM188R71H222KA01#		
	3300pF	±10%				GRM188R71H332KA01#		
	4700pF	±10%				GRM188R71H472KA01#		
	6800pF	±10%				GRM188R71H682KA01#		
	10000pF	±10%				GRM188R71H103KA01#		
	15000pF	±10%				GRM188R71H153KA01#		
	22000pF	±10%				GRM188R71H223KA01#		
	33000pF	±10%				GRM188R71H333KA61#		
	47000pF	±10%				GRM188R71H473KA61#		
	68000pF	±10%		GRM188R71H683KA93#				
	0.1μF	±10%		GRM188R71H104KA93#				
	R	R		R	220pF	±10%	GRM188R11H221KA01#	
					330pF	±10%	GRM188R11H331KA01#	
					470pF	±10%	GRM188R11H471KA01#	
680pF					±10%	GRM188R11H681KA01#		
1000pF					±10%	GRM188R11H102KA01#		
1500pF					±10%	GRM188R11H152KA01#		
2200pF					±10%	GRM188R11H222KA01#		
3300pF					±10%	GRM188R11H332KA01#		
4700pF					±10%	GRM188R11H472KA01#		
6800pF					±10%	GRM188R11H682KA01#		
10000pF					±10%	GRM188R11H103KA01#		
15000pF					±10%	GRM188R11H153KA01#		
22000pF					±10%	GRM188R11H223KA01#		
33000pF					±10%	GRM188R11H333KA61#		
47000pF					±10%	GRM188R11H473KA61#		
68000pF					±10%	GRM188R11H683KA93#		
0.1μF			±10%		GRM188R11H104KA93#			
X5R			X5R		X5R	1000pF	±10%	GRM188R61H102KA01#
	2200pF	±10%		GRM188R61H222KA01#				
	4700pF	±10%		GRM188R61H472KA01#				
	10000pF	±10%		GRM188R61H103KA01#				
	22000pF	±10%		GRM188R61H223KA01#				
	0.22μF	±10%		GRM188R61H224KAC4#				
	0.47μF	±10%		GRM188R61H474KA12#				

T max.	Rated Voltage	TC Code	Cap.	Tol.	Part Number	
0.9mm	50Vdc	X5R	0.47μF	±20%	GRM188R61H474MA12#	
			1.0μF	±10%	GRM188R61H105KAAL#	
				±20%	GRM188R61H105MAAL#	
			B	220pF	±10%	GRM188B11H221KA01#
					±20%	GRM188B11H221MA01#
				330pF	±10%	GRM188B11H331KA01#
					±20%	GRM188B11H331MA01#
				470pF	±10%	GRM188B11H471KA01#
					±20%	GRM188B11H471MA01#
				680pF	±10%	GRM188B11H681KA01#
		±20%			GRM188B11H681MA01#	
		1000pF		±10%	GRM188B11H102KA01#	
				±20%	GRM188B11H102MA01#	
		1500pF	±10%	GRM188B11H152KA01#		
			±20%	GRM188B11H152MA01#		
		2200pF	±10%	GRM188B11H222KA01#		
			±20%	GRM188B11H222MA01#		
		3300pF	±10%	GRM188B11H332KA01#		
			±20%	GRM188B11H332MA01#		
		4700pF	±10%	GRM188B11H472KA01#		
			±20%	GRM188B11H472MA01#		
		6800pF	±10%	GRM188B11H682KA01#		
			±20%	GRM188B11H682MA01#		
		10000pF	±10%	GRM188B11H103KA01#		
			±20%	GRM188B11H103MA01#		
	15000pF	±10%	GRM188B11H153KA01#			
		±20%	GRM188B11H153MA01#			
	22000pF	±10%	GRM188B11H223KA01#			
		±20%	GRM188B11H223MA01#			
	33000pF	±10%	GRM188B11H333KA61#			
		±20%	GRM188B11H333MA61#			
	47000pF	±10%	GRM188B11H473KA61#			
		±20%	GRM188B11H473MA61#			
	68000pF	±10%	GRM188B31H683KA92#			
		±20%	GRM188B31H683MA92#			
	0.1μF	±10%	GRM188B31H104KA92#			
		±20%	GRM188B31H104MA92#			
	0.15μF	±10%	GRM188B31H154KAC4#			
		±20%	GRM188B31H154MAC4#			
	0.22μF	±10%	GRM188B31H224KAC4#			
		±20%	GRM188B31H224MAC4#			
	1.0μF	±10%	GRM188B31H105KAAL#			
		±20%	GRM188B31H105MAAL#			
	25Vdc	X7R	X7R	15000pF	±10%	GRM188R71E153KA01#
				22000pF	±10%	GRM188R71E223KA01#
±20%					GRM188R71E223MA01#	
33000pF				±10%	GRM188R71E333KA01#	
47000pF				±10%	GRM188R71E473KA01#	
68000pF				±10%	GRM188R71E683KA01#	
0.15μF				±10%	GRM188R71E154KA01#	
0.22μF				±10%	GRM188R71E224KA88#	
0.47μF				±10%	GRM188R71E474KA12#	
1.0μF				±10%	GRM188R71E105KA12#	
	±20%	GRM188R71E105MA12#				

Part number # indicates the package specification code.

For General Purpose GRM Series

Capacitor Array GNM Series

Low ESL LLI Series

High-Q Type GJM Series

High Frequency GQM Series

Monolithic Microchip GMA Series

For Bonding GMD Series

Product Information

## GRM Series High Dielectric Constant Type Part Number List

(→ ■ 1.6x0.8mm)

T max.	Rated Voltage	TC Code	Cap.	Tol.	Part Number	T max.	Rated Voltage	TC Code	Cap.	Tol.	Part Number		
0.9mm	25Vdc	R	15000pF	±10%	GRM188R11E153KA01#	0.9mm	16Vdc	X7R	1.0μF	±20%	GRM188R71C105MA12#		
			22000pF	±10%	GRM188R11E223KA01#				±20%	GRM188R71C105ME15#			
				±20%	GRM188R11E223MA01#				X7S	0.68μF	±10%	GRM188C71C684KA12#	
			33000pF	±10%	GRM188R11E333KA01#					R	0.15μF	±10%	GRM188R11C154KA01#
			47000pF	±10%	GRM188R11E473KA01#						0.22μF	±10%	GRM188R11C224KA01#
			68000pF	±10%	GRM188R11E683KA01#						0.33μF	±10%	GRM188R11C334KA01#
			0.15μF	±10%	GRM188R11E154KA01#						0.47μF	±10%	GRM188R11C474KA88#
			0.22μF	±10%	GRM188R11E224KA88#					X6S	1.0μF	±10%	GRM188C81C105KA12#
				±10%	GRM188C81E105KAAD#						±20%	GRM188C81C105MA12#	
				±20%	GRM188C81E105MAAD#						2.2μF	±10%	GRM188C81C225KA12#
			±20%	GRM188C81C225MA12#	X5R			0.22μF			±10%	GRM188R61C224KA88#	
		0.1μF	±10%	GRM188R61E104KA01#				0.68μF			±10%	GRM188R61C684KA75#	
			±10%	GRM188R61E224KA88#				±20%	GRM188R61C684MA75#				
			±10%	GRM188R61E474KA12#				±20%	GRM188R61C684MA75#				
			±10%	GRM188R61E474MA12#				1.0μF	±10%		GRM188R61C105KA93#		
			±10%	GRM188R61E684KA75#				±20%	GRM188R61C105MA92#				
			±10%	GRM188R61E684MA75#				2.2μF	±10%		GRM188R61C225KE15#		
			±10%	GRM188R61E105KA12#				B	0.15μF	±10%	GRM188B11C154KA01#		
			±10%	GRM188R61E105MA12#					±20%	GRM188B11C224KA01#			
			±10%	GRM188R61E225KA12#					±20%	GRM188B11C224MA01#			
			±10%	GRM188R61E225MA12#	0.33μF				±10%	GRM188B11C334KA01#			
			±10%	GRM188R61E225MA12#	±20%				GRM188B11C334MA01#				
		2200pF	±10%	GRM188B11E222KA01#	0.68μF				±10%	GRM188B31C684KA75#			
		3300pF	±10%	GRM188B11E332KA01#	±20%				GRM188B31C684MA75#				
		4700pF	±10%	GRM188B11E472KA01#	1.0μF				±10%	GRM188B31C105KA92#			
		6800pF	±10%	GRM188B11E682KA01#	±20%				GRM188B31C105MA92#				
		10000pF	±10%	GRM188B11E103KA01#	2.2μF				±10%	GRM188B31C225KE14#			
			±20%	GRM188B11E103MA01#	10Vdc			X7R	0.33μF	±10%	GRM188R71A334KA61#		
		15000pF	±10%	GRM188B11E153KA01#					±20%	GRM188R71A334MA61#			
			±10%	GRM188B11E153MA01#					0.47μF	±10%	GRM188R71A474KA61#		
		22000pF	±10%	GRM188B11E223KA01#					0.68μF	±10%	GRM188R71A684KA61#		
			±20%	GRM188B11E223MA01#					±20%	GRM188R71A684MA61#			
		33000pF	±10%	GRM188B11E333KA01#					2.2μF	±10%	GRM188R71A225KE15#		
			±20%	GRM188B11E333MA01#					±20%	GRM188R71A225ME15#			
		47000pF	±10%	GRM188B11E473KA01#					X7T	2.2μF	±10%	GRM188D71A225KE34#	
			±20%	GRM188B11E473MA01#						±20%	GRM188D71A225ME34#		
		68000pF	±10%	GRM188B11E683KA01#						X6S	2.2μF	±10%	GRM188C81A225KE34#
			±20%	GRM188B11E683MA01#	±20%			GRM188C81A225ME34#					
		0.1μF	±10%	GRM188B11E104KA01#	X5R			0.33μF			±10%	GRM188R61A334KA61#	
			±20%	GRM188B11E104MA01#				±20%			GRM188R61A334MA61#		
		0.15μF	±10%	GRM188B11E154KA01#				0.68μF			±10%	GRM188R61A684KA61#	
		0.22μF	±10%	GRM188B31E224KA87#				±20%			GRM188R61A684MA61#		
		0.47μF	±10%	GRM188B31E474KA75#				2.2μF			±10%	GRM188R61A225KE34#	
			±20%	GRM188B31E474MA75#				±20%			GRM188R61A225ME34#		
		0.68μF	±10%	GRM188B31E684KA75#				B	0.33μF		±10%	GRM188B11A334KA61#	
			±20%	GRM188B31E684MA75#					±20%		GRM188B11A334MA61#		
		1.0μF	±10%	GRM188B31E105KA75#					0.68μF	±10%	GRM188B11A684KA61#		
			±20%	GRM188B31E105MA75#					±20%	GRM188B11A684MA61#			
		2.2μF	±10%	GRM188B31E225KA12#	2.2μF				±10%	GRM188B31A225KE33#			
			±20%	GRM188B31E225MA12#	±20%				GRM188B31A225ME33#				
	16Vdc	X7R	0.15μF	±10%	GRM188R71C154KA01#	6.3Vdc	X7R		1.0μF	±10%	GRM188R70J105KA01#		
			0.22μF	±10%	GRM188R71C224KA01#				±20%	GRM188R70J105MA01#			
			0.33μF	±10%	GRM188R71C334KA01#				X7S	2.2μF	±10%	GRM188C70J225KE20#	
			0.47μF	±10%	GRM188R71C474KA88#					±20%	GRM188C70J225ME20#		
			1.0μF	±10%	GRM188R71C105KA12#			X6S		2.2μF	±10%	GRM188C80J225KE19#	
				±10%	GRM188R71C105KE15#					±20%	GRM188C80J225ME19#		

Part number # indicates the package specification code.

For General Purpose GRM Series  
 Capacitor Array GNM Series  
 Low ESL LL□ Series  
 High-Q Type GJM Series  
 High Frequency GQM Series  
 Monolithic Microchip GMA Series  
 For Bonding GMD Series  
 Product Information



## GRM Series High Dielectric Constant Type Part Number List

(→ ■ 1.6x0.8mm)

T max.	Rated Voltage	TC Code	Cap.	Tol.	Part Number		
0.9mm	6.3Vdc	X6S	4.7μF	±10%	GRM188C80J475KE15#	Degrating	
				±20%	GRM188C80J475ME15#	Degrating	
			X5R	10μF	±20%	GRM188R60J106ME47#	
		B	10μF	±20%	GRM188B30J106ME47#		
		4Vdc	X6S	4.7μF	±10%	GRM188C80G475KE19#	
					±20%	GRM188C80G475ME19#	
	X5R			10μF	±20%	GRM188R60G106ME47#	
	B		10μF	±20%	GRM188B30G106ME46#		
	2.5Vdc		X6S	10μF	±20%	GRM188C80E106ME47#	Degrating
					X5R	4.7μF	±10%
		16Vdc		X5R	4.7μF	±10%	GRM188R61C475KAAJ#
			±20%			GRM188R61C475MAAJ#	Degrating
B			4.7μF	±10%	GRM188B31C475KAAJ#	Degrating	
				±20%	GRM188B31C475MAAJ#	Degrating	
0.95mm	25Vdc	X5R	4.7μF	±10%	GRM188R61E475KE11#		
				±20%	GRM188R61E475MAAJ#	Degrating	
				B	4.7μF	±10%	GRM188B31C475KAAJ#
				±20%	GRM188B31C475MAAJ#	Degrating	
	10Vdc	B	10μF	±20%	GRM188B31A106ME69#	Degrating	
				X5R	4.7μF	±10%	GRM188R6YA475KE15#
					±20%	GRM188R6YA475ME15#	
		25Vdc	X5R	4.7μF	±10%	GRM188R61E475KE15#	
					±20%	GRM188R61E475ME15#	
				B	10μF	±20%	GRM188R61E106MA73#
	1mm	16Vdc	X6S	10μF	±20%	GRM188C81C106MA73#	
					X5R	10μF	±20%
X7T			10μF	±20%	GRM188D71A106MA73#		
10Vdc		X6S	10μF	±20%	GRM188C81A106MA73#		
				X7T	10μF	±20%	GRM188D70J106MA73#
		X5R	22μF	±20%	GRM188R60J226MEA0#	Degrating	
6.3Vdc		X5R	22μF	±20%	GRM188B30J226MEA0#	Degrating	
				B	22μF	±20%	GRM188B30G226MEA0#
		X6S	22μF	±20%	GRM188C80G226MEA0#	Degrating	
4Vdc		X5R	22μF	±20%	GRM188R60G226MEA0#		
				B	22μF	±20%	GRM188B30G226MEA0#

■ 2.0x1.25mm

T max.	Rated Voltage	TC Code	Cap.	Tol.	Part Number		
0.7mm	25Vdc	X5R	1.0μF	±10%	GRM216R61E105KA12#		
				X6S	1.0μF	±10%	GRM216C81C105KA12#
0.95mm	100Vdc	X7R	6800pF	±10%	GRM219R72A682KA01#		
				±20%	GRM219R72A103KA01#		
			X5R	10μF	±20%	GRM219R72A103MA01#	
		50Vdc	X7R	10000pF	±10%	GRM219R71H103KA01#	
					±20%	GRM219R71H103MA01#	
			X5R	15000pF	±10%	GRM219R71H153KA01#	
				±20%	GRM219R71H153MA01#		
	10Vdc	X7R	33000pF	±10%	GRM219R71H333KA01#		
				0.33μF	±10%	GRM219R71H334KA88#	
			R	33000pF	±10%	GRM219R11H333KA01#	
		X5R	1.0μF	±10%	GRM219R61H105KA73#		
				±20%	GRM219R61H105MA73#		
B			2.2μF	±10%	GRM219R61H225KE15#		
			±20%	GRM219R61H225ME15#			
B	33000pF	±10%	GRM219B11H333KA01#				
		0.33μF	±10%	GRM219B31H334KA87#			

T max.	Rated Voltage	TC Code	Cap.	Tol.	Part Number			
0.95mm	50Vdc	B	0.33μF	±20%	GRM219B31H334MA87#			
				±10%	GRM219B31H105KA73#			
				±20%	GRM219B31H105MA73#			
			2.2μF	±10%	GRM219B31H225KE15#			
				±20%	GRM219B31H225ME15#			
			35Vdc	X6S	2.2μF	±10%	GRM219C8YA225KE15#	
		±20%				GRM219C8YA225ME15#		
		X5R			4.7μF	±10%	GRM219R6YA475KA73#	Degrating
					±20%	GRM219R6YA475MA73#	Degrating	
		25Vdc		X7R	68000pF	±10%	GRM219R71E683KA01#	
						0.1μF	±10%	GRM219R71E104KA01#
			±20%			GRM219R71E104MA01#		
	0.68μF		±10%		GRM219R71E684KA88#			
			1.0μF		±10%	GRM219R71E105KA88#		
			R		68000pF	±10%	GRM219R11E683KA01#	
	X6S		2.2μF	±10%	GRM219C81E225KE15#			
				±20%	GRM219C81E225ME15#			
			X5R	2.2μF	±10%	GRM219R61E225KA12#		
				±20%	GRM219R61E225MA12#			
	16Vdc		X7R	0.33μF	±10%	GRM219R71C334KA88#		
					0.68μF	±10%	GRM219R71C684KA01#	
		2.2μF		±10%	GRM219R71C225KE15#			
				±20%	GRM219R71C225ME15#			
		X6S	4.7μF	±10%	GRM219C81C475KA73#			
				±20%	GRM219C81C475MA73#			
	X5R		4.7μF	±10%	GRM219R61C475KE15#			
			±10%	GRM219R61C106KA73#				
			±20%	GRM219R61C106MA73#				
	10Vdc	X7R	0.68μF	±10%	GRM219B11C684KA01#			
				4.7μF	±10%	GRM219B31C475KE15#		
				10μF	±10%	GRM219B31C106KA73#		
					±20%	GRM219B31C106MA73#		
			10Vdc	X7R	2.2μF	±10%	GRM219R71A225KE15#	
						±20%	GRM219R71A225ME15#	
		X7T		4.7μF	±10%	GRM219D71A475KE15#	Degrating	
				±20%	GRM219D71A475ME15#	Degrating		
6.3Vdc		X6S	10μF	±10%	GRM219C80J106KE39#			
				±20%	GRM219C80J106ME39#			
		X5R	22μF	±20%	GRM219R60J226ME47#	Degrating		
B		22μF	±20%	GRM219B30J226ME47#	Degrating			

Part number # indicates the package specification code.

## GRM Series High Dielectric Constant Type Part Number List

(→ ■ 2.0x1.25mm)

T max.	Rated Voltage	TC Code	Cap.	Tol.	Part Number				
0.95mm	4Vdc	X6S	10μF	±10%	GRM219C80G106KE19#				
				±20%	GRM219C80G106ME19#				
		X5R	47μF	±20%	GRM219R60G476ME44#	Derating			
1mm	100Vdc	X7R	0.22μF	±10%	GRM21AR72A224KAC5#				
				±10%	GRM21AR72A334KAC5#				
	50Vdc	X7R	22000pF	±10%	GRM219R71H223KA17#				
				±20%	GRM219R71H223MA17#				
1.35mm	100Vdc	X7R	10000pF	±10%	GRM21BR72A103KA01#				
				±10%	GRM21BR72A153KA01#				
				±10%	GRM21BR72A223KA01#				
				±10%	GRM21BR72A333KA01#				
				±10%	GRM21BR72A473KA01#				
				±10%	GRM21BR72A683KAC4#				
						±20%	GRM21BR72A683MAC4#		
				0.1μF	±10%	GRM21BR72A104KAC4#			
							±20%	GRM21BR72A104MAC4#	
				50Vdc	X7R	47000pF	±10%	GRM21BR71H473KA01#	
							±10%	GRM21BR71H683KA01#	
							0.1μF	±10%	GRM21BR71H104KA01#
	±20%	GRM21BR71H104MA01#							
	0.15μF	±10%	GRM21BR71H154KA01#						
		±10%	GRM21BR71H224KA01#						
	0.47μF	±10%	GRM21BR71H474KA88#						
		±10%	GRM21BR71H105KA12#						
	R	47000pF	±10%		GRM21BR11H473KA01#				
			±10%		GRM21BR11H683KA01#				
	0.1μF	±10%	GRM21BR11H104KA01#						
		±20%	GRM21BR11H104MA01#						
	X5R	1.0μF	±10%	GRM21BR61H105KA12#					
			B	47000pF	±10%	GRM21BB11H473KA01#			
					±10%	GRM21BB11H683KA01#			
			0.1μF	±10%	GRM21BB11H104KA01#				
				±20%	GRM21BB11H104MA01#				
			0.15μF	±10%	GRM21BB31H154KA88#				
				±20%	GRM21BB31H154MA88#				
			0.22μF	±10%	GRM21BB31H224KA88#				
				±20%	GRM21BB31H224MA88#				
0.47μF			±10%	GRM21BB31H474KA87#					
			±20%	GRM21BB31H474MA87#					
0.68μF			±10%	GRM21BB31H684KAC4#					
	±20%	GRM21BB31H684MAC4#							
1.0μF	±10%	GRM21BB31H105KA12#							
	±20%	GRM21BB31H105MA12#							
25Vdc	X7R	0.1μF	±10%	GRM21BR71E104KA01#					
			±10%	GRM21BR71E154KA01#					
	R	0.1μF	±10%	GRM21BR11E104KA01#					
			±20%	GRM21BR11E154MA01#					
		0.15μF	±10%	GRM21BR11E154KA01#					
			±20%	GRM21BR11E154MA01#					
	0.68μF	±10%	GRM21BR11E684KA88#						
		±10%	GRM21BC81E475KA12#						
	±20%	GRM21BC81E475MA12#							
			X5R	2.2μF	±10%	GRM21BR61E225KA12#			
	±20%	GRM21BR61E225MA12#							
	4.7μF	±10%	GRM21BR61E475KA12#						

T max.	Rated Voltage	TC Code	Cap.	Tol.	Part Number			
1.35mm	25Vdc	X5R	4.7μF	±20%	GRM21BR61E475MA12#			
				B	0.15μF	±10%	GRM21BB11E154KA01#	
						±10%	GRM21BB11E224KA01#	
				0.22μF	±10%	GRM21BB11E334KA01#		
					±10%	GRM21BB11E475KA01#		
				2.2μF	±10%	GRM21BB31E225KA75#		
		±20%	GRM21BB31E225MA75#					
		4.7μF	±10%	GRM21BB31E475KA75#				
			±20%	GRM21BB31E475MA75#				
		16Vdc	X7R	2.2μF	±10%	GRM21BR71C225KA12#		
					±20%	GRM21BR71C225MA12#		
			X6S	4.7μF	±10%	GRM21BC81C475KA88#		
	±10%				GRM21BR61C225KA88#			
	X5R		4.7μF	±10%	GRM21BR61C475KA88#			
				±10%	GRM21BR61C106KE15#			
	10μF	±10%	GRM21BR61C106ME15#					
		B	2.2μF	±10%	GRM21BB31C225KA87#			
	±10%			GRM21BB31C475KA87#				
10μF	±10%	GRM21BB31C106KE15#						
	±20%	GRM21BB31C106ME15#						
10Vdc	X6S	10μF	±10%	GRM21BC81A106KE18#				
			±20%	GRM21BC81A106ME18#				
6.3Vdc	X6S	10μF	±10%	GRM21BC80J106KE19#				
			±20%	GRM21BC80J106ME19#				
1.4mm	100Vdc	X7R	0.47μF	±10%	GRM21BR72A474KA73#			
				±10%	GRM21BR61H225KA73#			
		X5R	2.2μF	±10%	GRM21BR61H225MA73#			
				±10%	GRM21BR61H475KE51#			
	±20%	GRM21BR61H475ME51#						
			B	2.2μF	±10%	GRM21BB31H225KA73#		
	±20%	GRM21BB31H225MA73#						
	4.7μF	±10%	GRM21BB31H475KE51#					
		±20%	GRM21BB31H475ME51#					
	25Vdc	X7R	1.0μF	±10%	GRM21BR71E105KA99#			
				±10%	GRM21BR71E225KA73#			
		R	1.0μF	±10%	GRM21BR11E105KA99#			
±10%				GRM21BR61E106KA73#				
±20%		GRM21BR61E106MA73#						
			B	1.0μF	±10%	GRM21BB31E105KA98#		
±10%	GRM21BB31E106KA73#							
±20%	GRM21BB31E106MA73#							
16Vdc	X7R	4.7μF	±10%	GRM21BR71C475KA73#				
			±20%	GRM21BR71C475MA73#				
	X6S	10μF	±10%	GRM21BC81C106KA73#				
			±20%	GRM21BC81C106MA73#				
10Vdc	X7R	4.7μF	±10%	GRM21BR71A475KA73#				
			±20%	GRM21BR71A475MA73#				
	10μF	±10%	GRM21BR71A106KE51#					
		±20%	GRM21BR71A106ME51#					
B	2.2μF	±20%	GRM21BB31A226ME51#	Derating				
		X7R	10μF	±10%	GRM21BR70J106KE76#			
±20%	GRM21BR70J106ME76#							
6.3Vdc	X6S	22μF	±20%	GRM21BC80J226ME51#	Derating			
			X5R	22μF	±20%	GRM21BR60J226ME39#		
	B	22μF			±20%	GRM21BB30J226ME38#		

For General Purpose GRM Series  
 Capacitor Array GNM Series  
 Low ESL LL□ Series  
 High-Q Type GJM Series  
 High Frequency GQM Series  
 Monolithic Microchip GMA Series  
 For Bonding GMD Series  
 Product Information

Part number # indicates the package specification code.

## GRM Series High Dielectric Constant Type Part Number List

(→ ■ 2.0x1.25mm)

T max.	Rated Voltage	TC Code	Cap.	Tol.	Part Number	
1.4mm	4Vdc	X7U	22μF	±20%	GRM21BE70G226ME51#	
		X6S	22μF	±20%	GRM21BC80G226ME39#	
1.45mm	25Vdc	X5R	22μF	±20%	GRM21BR61E226ME44#	
	6.3Vdc	X5R	47μF	±20%	GRM21BR60J476ME15#	Derating
		B	47μF	±20%	GRM21BB30J476ME15#	Derating
	4Vdc	X6S	47μF	±20%	GRM21BC80G476ME15#	Derating
		X5R	47μF	±20%	GRM21BR60G476ME15#	
B		47μF	±20%	GRM21BB30G476ME15#		

■ 3.2x1.6mm

T max.	Rated Voltage	TC Code	Cap.	Tol.	Part Number		
0.7mm	25Vdc	X5R	2.2μF	±10%	GRM316R61E225KA12#		
		B	2.2μF	±10%	GRM316B31E225KA75#		
0.95mm	16Vdc	X6S	2.2μF	±10%	GRM316C81C225KA12#		
	100Vdc	X7R	15000pF	±10%	GRM319R72A153KA01#		
			0.1μF	±10%	GRM319R72A104KA01#		
	50Vdc	X7R	0.33μF	±10%	GRM319R71H334KA01#		
	35Vdc	X5R	10μF	±10%	GRM319R6YA106KA12#	Derating	
			±20%	GRM319R6YA106MA12#	Derating		
	25Vdc	X7R	0.33μF	±10%	GRM319R71E334KA01#		
			R	0.33μF	±10%	GRM319R11E334KA01#	
			B	0.33μF	±10%	GRM319B11E334KA01#	
	16Vdc	X6S	4.7μF	±10%	GRM319C81C475KA12#		
X5R			10μF	±10%	GRM319R61C106KE15#		
10Vdc	X5R	±20%	GRM319R61C106ME15#				
		B	0.47μF	±10%	GRM319B11C474KA01#		
		10μF	±10%	GRM319B31C106KE15#			
		±20%	GRM319B31C106ME15#				
		B	22μF	±20%	GRM319B31A226ME15#		
6.3Vdc	X6S	22μF	±20%	GRM319C80J226ME15#			
		X5R	22μF	±20%	GRM319R60J226ME15#		
		B	22μF	±20%	GRM319B30J226ME15#		
		0.22μF	±10%	GRM31MR72A224KA01#			
1.25mm	100Vdc	X7R	22000pF	±10%	GRM31MR72A223KA01#		
			33000pF	±10%	GRM31MR72A333KA01#		
			47000pF	±10%	GRM31MR72A473KA01#		
			68000pF	±10%	GRM31MR72A683KA01#		
			0.15μF	±10%	GRM31MR72A154KA01#		
			0.22μF	±10%	GRM31MR72A224KA01#		
	50Vdc	X7R	0.15μF	±10%	GRM31MR71H154KA01#		
			0.22μF	±10%	GRM31MR71H224KA01#		
			0.47μF	±10%	GRM31MR71H474KA01#		
			0.68μF	±10%	GRM31MR71H684KA88#		
			1.0μF	±10%	GRM31MR71H105KA88#		
			R	0.15μF	±10%	GRM31MR11H154KA01#	
			0.22μF	±10%	GRM31MR11H224KA01#		
			B	0.15μF	±10%	GRM31MB11H154KA01#	
			0.22μF	±10%	GRM31MB11H224KA01#		
25Vdc	X5R	10μF	±20%	GRM31MR61E106MA12#			
		B	0.22μF	±10%	GRM31MB11E224KA01#		

T max.	Rated Voltage	TC Code	Cap.	Tol.	Part Number		
1.25mm	16Vdc	X6S	10μF	±10%	GRM31MC81C106KA12#		
		B	0.68μF	±10%	GRM31MB11C684KA01#		
1.3mm	100Vdc	X7R	0.47μF	±10%	GRM31MR72A474KA35#		
			±20%	GRM31MR72A474MA35#			
		0.68μF	±10%	GRM31MR72A684KA35#			
		B	2.2μF	±10%	GRM31MB31E225KA92#		
1.8mm	100Vdc	X7R	1.0μF	±10%	GRM31CR72A105KA01#		
			2.2μF	±10%	GRM31CR71H225KA88#		
			4.7μF	±10%	GRM31CR71H475KA12#		
		B	2.2μF	±10%	GRM31CB31H225KA87#		
			±20%	GRM31CB31H225MA87#			
			4.7μF	±10%	GRM31CB31H475KA12#		
	25Vdc	X7R	4.7μF	±10%	GRM31CR71E475KA88#		
			10μF	±10%	GRM31CR71E106KA12#		
			±20%	GRM31CR71E106MA12#			
		X6S	10μF	±10%	GRM31CC81E106KE15#		
			±20%	GRM31CC81E106MA12#			
			X5R	10μF	±10%	GRM31CR61E106KA12#	
16Vdc	X7R	22μF	±20%	GRM31CR61E226ME15#			
		B	10μF	±10%	GRM31CB31E106KA75#		
		22μF	±20%	GRM31CB31E226ME15#			
	X7R	4.7μF	±20%	GRM31CR71C475MA01#			
		10μF	±10%	GRM31CR71C106KAC7#			
		±20%	GRM31CR71C106MAC7#				
10Vdc	X7R	R	4.7μF	±20%	GRM31CR11C475MA01#		
		X6S	22μF	±20%	GRM31CC81C226ME15#		
		X5R	10μF	±10%	GRM31CR61C106KA88#		
	B	22μF	±20%	GRM31CR61C226ME15#			
		10μF	±10%	GRM31CB31C106KA88#			
		22μF	±20%	GRM31CB31C226ME15#			
		X7R	22μF	±20%	GRM31CR71A226ME15#		
	6.3Vdc	X7R	X6S	22μF	±20%	GRM31CC81A226ME19#	
			X5R	22μF	±20%	GRM31CR61A226ME19#	
			B	47μF	±20%	GRM31CR61A476ME15#	
X7U		22μF	±20%	GRM31CB31A226ME19#			
		47μF	±20%	GRM31CB31A476ME15#			
		22μF	±20%	GRM31CR70J226ME19#			
4Vdc	X7U	47μF	±20%	GRM31CE70J476ME15#	Derating		
		X6S	22μF	±20%	GRM31CC80J226ME19#		
		47μF	±20%	GRM31CC80J476ME18#			
	X5R	47μF	±20%	GRM31CR60J476ME19#			
		B	47μF	±20%	GRM31CB30J476ME18#		
		X6S	47μF	±20%	GRM31CE70G476ME15#		
1.9mm	100Vdc	X7R	2.2μF	±10%	GRM31CR72A225KA73#		
			±20%	GRM31CR72A225MA73#			
		X6T	100μF	±20%	GRM31CD80J107ME39#	Derating	
			X5R	100μF	±20%	GRM31CR60J107ME39#	
	4Vdc	X7U	100μF	±20%	GRM31CE70G107ME39#	Derating	
			X6T	100μF	±20%	GRM31CD80G107ME39#	
		X5R	100μF	±20%	GRM31CR60G107ME39#		

Part number # indicates the package specification code.

## GRM Series High Dielectric Constant Type Part Number List

### ■ 3.2x2.5mm

T max.	Rated Voltage	TC Code	Cap.	Tol.	Part Number		
1mm	6.3Vdc	X5S	150μF	±20%	GRM32RC60J157ME15#	Derating	
	4Vdc	X6T	150μF	±20%	GRM32RD80G157ME15#	Derating	
		X5S	150μF	±20%	GRM32RC60G157ME15#		
	2.5Vdc	X6T	150μF	±20%	GRM32RD80E157ME15#		
1.5mm	50Vdc	X7R	0.68μF	±10%	GRM32NR71H684KA01#		
		B	0.68μF	±10%	GRM32NB11H684KA01#		
1.8mm	100Vdc	X7R	0.68μF	±10%	GRM32CR72A684KA01#		
			1.0μF	±10%	GRM32CR72A105KA35#		
2.2mm	25Vdc	X7R	10μF	±10%	GRM32DR71E106KA12#		
		X6S	10μF	±10%	GRM32DC81E106KA12#		
2.7mm	100Vdc	X7R	2.2μF	±10%	GRM32ER72A225KA35#		
				±20%	GRM32ER72A225MA35#		
			4.7μF	±10%	GRM32ER71H475KA88#		
				±10%	GRM32ER71H106KA12#		
	X5R	10μF	±10%	GRM32ER61H106KA12#			
			±20%	GRM32ER61H106MA12#			
		4.7μF	±10%	GRM32EB31H475KA87#			
			±10%	GRM32EB31H106KA12#			
	±20%	GRM32EB31H106MA12#					
		35Vdc	X7R	10μF	±10%	GRM32ER7YA106KA12#	
			X5R	10μF	±10%	GRM32ER6YA106KA12#	
	B		10μF	±10%	GRM32EB3YA106KA12#		
	25Vdc	X7R	22μF	±20%	GRM32ER71E226ME15#		
		X6S	22μF	±20%	GRM32EC81E226ME15#		
		X5R	22μF	±20%	GRM32ER61E226ME15#		
		B	22μF	±20%	GRM32EB31E226ME15#		
	16Vdc	X7R	22μF	±20%	GRM32ER71C226MEA8#		
		X6S	47μF	±20%	GRM32EC81C476ME15#	Derating	
		X5R	47μF	±20%	GRM32ER61C476ME15#		
		B	22μF	±20%	GRM32EB31C226ME16#		
			47μF	±20%	GRM32EB31C476ME15#		
	10Vdc	X7R	47μF	±20%	GRM32ER71A476ME15#		
		X6S	47μF	±20%	GRM32EC81A476ME19#		
X5R		47μF	±20%	GRM32ER61A476ME20#			
B		47μF	±20%	GRM32EB31A476ME20#			
6.3Vdc	X7R	47μF	±20%	GRM32ER70J476ME20#			
	X7U	100μF	±20%	GRM32EE70J107ME15#	Derating		
	X6S	47μF	±20%	GRM32EC80J476ME64#			
		100μF	±20%	GRM32EC80J107ME20#			
	X5R	100μF	±20%	GRM32ER60J107ME20#			
	B	100μF	±20%	GRM32EB30J107ME16#			
4Vdc	X7U	100μF	±20%	GRM32EE70G107ME19#			
	X6S	100μF	±20%	GRM32EC80G107ME20#			

For General Purpose  
GRM Series

Capacitor Array  
GNM Series

Low ESL  
LL□ Series

High-Q Type  
GJM Series

High Frequency  
GQM Series

Monolithic Microchip  
GMA Series

For Bonding  
GMD Series

Product Information

## Chip Monolithic Ceramic Capacitors

# Capacitor Array GNM Series

Ideal for reducing the mounting area and mounting costs.

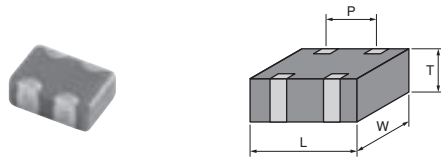

2 Elements

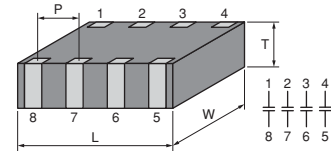
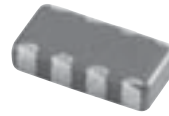

4 Elements

- 1 The number of parts can be reduced.
- 2 Also contributes to the low profile of the set.
- 3 Ideal for decoupling and smoothing.
- 4 Reduction of environmental impact substances is possible.  
 (Accommodates 2 or 4 times the number of individual chips per reel.)

For General Purpose  
GRM Series

Capacitor Array  
GNM Series

Low ESL  
LLQ Series

High-Q Type  
GJM Series

High Frequency  
GQM Series

Monolithic Microchip  
GMA Series

For Bonding  
GMD Series

Product Information



## GNM Series High Dielectric Constant Type Part Number List

### ■ 2 Elements 0.9×0.6mm

T max.	Rated Voltage	TC Code	Cap.	Tol.	Part Number		
0.5mm	16Vdc	X5R	10000pF	±20%	<b>GNM0M2R61C103ME18#</b>		
			22000pF	±20%	<b>GNM0M2R61C223ME18#</b>		
			47000pF	±20%	<b>GNM0M2R61C473ME18#</b>		
			0.1μF	±20%	<b>GNM0M2R61C104ME18#</b>		
			B	10000pF	±20%	<b>GNM0M2B31C103ME18#</b>	
				22000pF	±20%	<b>GNM0M2B31C223ME18#</b>	
		47000pF		±20%	<b>GNM0M2B31C473ME18#</b>		
		0.1μF		±20%	<b>GNM0M2B31C104ME18#</b>		
		10Vdc		X5R	10000pF	±20%	<b>GNM0M2R61A103ME17#</b>
					22000pF	±20%	<b>GNM0M2R61A223ME17#</b>
			47000pF		±20%	<b>GNM0M2R61A473ME17#</b>	
			0.1μF		±20%	<b>GNM0M2R61A104ME17#</b>	
	B		10000pF	±20%	<b>GNM0M2B31A103ME17#</b>		
			22000pF	±20%	<b>GNM0M2B31A223ME17#</b>		
	4Vdc	X5R	1.0μF	±20%	<b>GNM0M2R60G105ME17#</b>		
			B	1.0μF	±20%	<b>GNM0M2B30G105ME17#</b>	

### ■ 2 Elements 1.37×1.0mm

T max.	Rated Voltage	TC Code	Cap.	Tol.	Part Number	
0.55mm	16Vdc	X7R	0.1μF	±20%	<b>GNM1M2R71C104MAA1#</b>	
		R	0.1μF	±20%	<b>GNM1M2R11C104MAA1#</b>	
		X5R	1.0μF	±20%	<b>GNM1M2R61C105MEA2#</b>	
		B	0.1μF	±20%	<b>GNM1M2B11C104MAA1#</b>	
	10Vdc	X5R	1.0μF	±20%	<b>GNM1M2R61A105MEA4#</b>	
0.7mm	50Vdc	X7R	1000pF	±20%	<b>GNM1M2R71H102MA01#</b>	
			R	1000pF	±20%	<b>GNM1M2R11H102MA01#</b>
			X5R	1000pF	±20%	<b>GNM1M2R61H102MA01#</b>
			B	1000pF	±20%	<b>GNM1M2B11H102MA01#</b>
		25Vdc	X7R	2200pF	±20%	<b>GNM1M2R71E222MA01#</b>
				4700pF	±20%	<b>GNM1M2R71E472MA01#</b>
				10000pF	±20%	<b>GNM1M2R71E103MA01#</b>
			R	2200pF	±20%	<b>GNM1M2R11E222MA01#</b>
	4700pF			±20%	<b>GNM1M2R11E472MA01#</b>	
	10000pF			±20%	<b>GNM1M2R11E103MA01#</b>	
	X5R	2200pF	±20%	<b>GNM1M2R61E222MA01#</b>		
		4700pF	±20%	<b>GNM1M2R61E472MA01#</b>		
		10000pF	±20%	<b>GNM1M2R61E103MA01#</b>		
	16Vdc	X7R	2200pF	±20%	<b>GNM1M2B11E222MA01#</b>	
			4700pF	±20%	<b>GNM1M2B11E472MA01#</b>	
			10000pF	±20%	<b>GNM1M2B11E103MA01#</b>	
			X5R	2200pF	±20%	<b>GNM1M2R61C223MA01#</b>
		R	2200pF	±20%	<b>GNM1M2R11C223MA01#</b>	
			4700pF	±20%	<b>GNM1M2R11C473MA01#</b>	
	10000pF		±20%	<b>GNM1M2R11C104MA01#</b>		
0.1μF	±20%		<b>GNM1M2R11C104MA01#</b>			

T max.	Rated Voltage	TC Code	Cap.	Tol.	Part Number			
0.7mm	16Vdc	X5R	47000pF	±20%	<b>GNM1M2R61C473MA01#</b>			
			B	22000pF	±20%	<b>GNM1M2B11C223MA01#</b>		
			47000pF	±20%	<b>GNM1M2B11C473MA01#</b>			
		10Vdc	X7R	22000pF	±20%	<b>GNM1M2R71A223MA01#</b>		
				47000pF	±20%	<b>GNM1M2R71A473MA01#</b>		
				0.1μF	±20%	<b>GNM1M2R71A104MA01#</b>		
			R	22000pF	±20%	<b>GNM1M2R11A223MA01#</b>		
				47000pF	±20%	<b>GNM1M2R11A473MA01#</b>		
				0.1μF	±20%	<b>GNM1M2R11A104MA01#</b>		
	6.3Vdc	X5R	22000pF	±20%	<b>GNM1M2R61A223MA01#</b>			
			47000pF	±20%	<b>GNM1M2R61A473MA01#</b>			
			0.1μF	±20%	<b>GNM1M2R61A104MA01#</b>			
		B	22000pF	±20%	<b>GNM1M2B11A223MA01#</b>			
			47000pF	±20%	<b>GNM1M2B11A473MA01#</b>			
			0.1μF	±20%	<b>GNM1M2B11A104MA01#</b>			
			0.8mm	16Vdc	X5R	0.22μF	±20%	<b>GNM1M2R61C224ME18#</b>
						1.0μF	±20%	<b>GNM1M2R61C105ME18#</b>
					B	1.0μF	±20%	<b>GNM1M2B31C105ME18#</b>
10Vdc	X5R	1.0μF		±20%	<b>GNM1M2R61A105ME17#</b>			
		2.2μF		±20%	<b>GNM1M2R61A225ME18#</b>			
		0.22μF		±20%	<b>GNM1M2B31A224ME17#</b>			
	B	0.47μF		±20%	<b>GNM1M2B31A474ME17#</b>			
		1.0μF		±20%	<b>GNM1M2B31A105ME17#</b>			
		2.2μF		±20%	<b>GNM1M2B31A225ME18#</b>			
6.3Vdc	X5R	2.2μF	±20%	<b>GNM1M2R60J225ME18#</b>				
	B	2.2μF	±20%	<b>GNM1M2B30J225ME18#</b>				

### ■ 4 Elements 2.0×1.25mm

T max.	Rated Voltage	TC Code	Cap.	Tol.	Part Number	
0.55mm	16Vdc	X7R	0.1μF	±20%	<b>GNM214R71C104MAA1#</b>	
			R	0.1μF	±20%	<b>GNM214R11C104MAA1#</b>
			B	0.1μF	±20%	<b>GNM214B11C104MAA1#</b>
		10Vdc	X5R	0.22μF	±20%	<b>GNM214R61A224MEA2#</b>
				1.0μF	±20%	<b>GNM214R61A105MEA2#</b>
				B	0.22μF	±20%
	6.3Vdc	X5R	1.0μF	±20%	<b>GNM214B31A105MEA2#</b>	
			0.22μF	±20%	<b>GNM214R60J224MEA2#</b>	
			1.0μF	±20%	<b>GNM214R60J105MEA2#</b>	
		B	0.22μF	±20%	<b>GNM214B30J224MEA2#</b>	
			1.0μF	±20%	<b>GNM214B30J105MEA2#</b>	
			0.22μF	±20%	<b>GNM214B11E472MA01#</b>	
0.7mm	50Vdc	X7R	470pF	±20%	<b>GNM214R71H471MA01#</b>	
			1000pF	±20%	<b>GNM214R71H102MA01#</b>	
			R	1000pF	±20%	<b>GNM214R11H102MA01#</b>
		B	470pF	±20%	<b>GNM214B11H471MA01#</b>	
			1000pF	±20%	<b>GNM214B11H102MA01#</b>	
			25Vdc	X7R	2200pF	±20%
	4700pF	±20%	<b>GNM214R71E472MA01#</b>			
	10000pF	±20%	<b>GNM214R71E103MA01#</b>			
	16Vdc	R	2200pF	±20%	<b>GNM214R11E222MA01#</b>	
			4700pF	±20%	<b>GNM214R11E472MA01#</b>	
			10000pF	±20%	<b>GNM214R11E103MA01#</b>	
		B	2200pF	±20%	<b>GNM214B11E222MA01#</b>	
4700pF			±20%	<b>GNM214B11E472MA01#</b>		
10000pF			±20%	<b>GNM214B11E103MA01#</b>		

Part number # indicates the package specification code.



## GNM Series High Dielectric Constant Type Part Number List

(→ ■ 4 Elements 2.0×1.25mm)

T max.	Rated Voltage	TC Code	Cap.	Tol.	Part Number
0.7mm	25Vdc	B	10000pF	±20%	<b>GNM214B11E103MA01#</b>
0.95mm	16Vdc	X7R	22000pF	±20%	<b>GNM214R71C223MA01#</b>
			47000pF	±20%	<b>GNM214R71C473MA01#</b>
			0.1μF	±20%	<b>GNM214R71C104MA01#</b>
		R	22000pF	±20%	<b>GNM214R11C223MA01#</b>
			47000pF	±20%	<b>GNM214R11C473MA01#</b>
			0.1μF	±20%	<b>GNM214R11C104MA01#</b>
		B	22000pF	±20%	<b>GNM214B11C223MA01#</b>
			47000pF	±20%	<b>GNM214B11C473MA01#</b>
			0.1μF	±20%	<b>GNM214B11C104MA01#</b>
	10Vdc	X5R	1.0μF	±20%	<b>GNM214R61A105ME17#</b>
			B	1.0μF	±20%
	6.3Vdc	X5R	1.0μF	±20%	<b>GNM214R60J105ME17#</b>
B			1.0μF	±20%	<b>GNM214B30J105ME17#</b>

For General Purpose GRM Series

Capacitor Array GNM Series

Low ESL LLQ Series

High-Q Type GJM Series

High Frequency GQM Series

Monolithic Microchip GMA Series

For Bonding GMD Series

Product Information

Part number # indicates the package specification code.

# Chip Monolithic Ceramic Capacitors

## Low ESL LLL/LLR/LLA/LLM Series

**Low  
ESL**

**LLL Series** Ideal decoupling solution for equipment having advanced features.

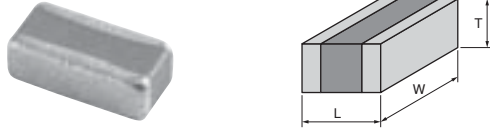

- 1 Ideal for IC decoupling of high-speed operating equipment, due to the low inductance value (ESL value).
- 2 LW reversed geometry type/multi-terminal type and a large lineup of capacitors are available according to performance requirements.

**LLR Series** Low ESL capacitor that suppresses the anti-resonance in circuits.



- 1 Reduces the anti-resonance generated in the high-frequency range.
- 2 An optimal ESR value can be selected from four types, according to the characteristics of the circuit.
- 3 The low ESL type, is also ideal as a decoupling component.

**LLA Series** Ideal decoupling solution for equipment having advanced features.

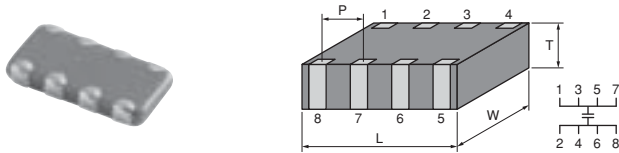

- 1 Ideal for IC decoupling of high-speed operating equipment, due to the low inductance value (ESL value).
- 2 LW reversed geometry type/multi-terminal type and a large lineup of capacitors are available according to performance requirements.

**LLM Series** Ideal decoupling solution for equipment having advanced features.

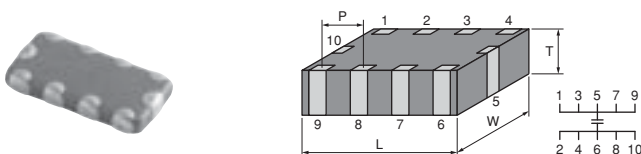

- 1 Ideal for IC decoupling of high-speed operating equipment, due to the low inductance value (ESL value).
- 2 LW reversed geometry type/multi-terminal type and a large lineup of capacitors are available according to performance requirements.

For General Purpose  
GRM Series

Capacitor Array  
GMM Series

Low ESL  
LL□ Series

High-Q Type  
GJM Series

High Frequency  
GQM Series

Monolithic Microchip  
GMA Series

For Bonding  
GMD Series

Product Information

## LLL Series High Dielectric Constant Type Low ESL Part Number List

### ■ 0.5×1.0mm

T max.	Rated Voltage	TC Code	Cap.	Tol.	Part Number
0.35mm	6.3Vdc	X6S	0.1μF	±20%	LLL153C80J104ME01#
			0.22μF	±20%	LLL153C80J224ME14#
	4Vdc	X7S	0.47μF	±20%	LLL153C70G474ME17#

### ■ 0.8×1.6mm

T max.	Rated Voltage	TC Code	Cap.	Tol.	Part Number		
0.5mm	25Vdc	X7R	10000pF	±20%	LLL185R71E103MA11#		
			16Vdc	X7R	22000pF	±20%	LLL185R71C223MA11#
			47000pF		±20%	LLL185R71C473MA11#	
	10Vdc	X7R	0.1μF	±20%	LLL185R71A104MA11#		
	4Vdc	X7S	0.22μF	±20%	LLL185C70G224MA11#		
0.55mm	4Vdc	X7S	1.0μF	±20%	LLL185C70G105ME01#		
			2.2μF	±20%	LLL185C70G225ME01#		
0.6mm	50Vdc	X7R	2200pF	±20%	LLL185R71H222MA01#		
			4700pF	±20%	LLL185R71H472MA01#		
			10000pF	X7R	±20%	LLL185R71E103MA01#	
	22000pF	±20%	LLL185R71E223MA01#				
	16Vdc	X7R	47000pF	±20%	LLL185R71C473MA01#		
	10Vdc	X7R	0.1μF	±20%	LLL185R71A104MA01#		
	0.22μF		±20%	LLL185R71A224MA01#			
4Vdc	X7S	0.47μF	±20%	LLL185C70G474MA01#			

### ■ 1.25×2.0mm

T max.	Rated Voltage	TC Code	Cap.	Tol.	Part Number
0.5mm	50Vdc	X7R	10000pF	±20%	LLL215R71H103MA11#
			25Vdc	X7R	22000pF
	16Vdc	X7R	47000pF	±20%	LLL215R71C473MA11#
			0.1μF	±20%	LLL215R71C104MA11#
	10Vdc	X7R	0.22μF	±20%	LLL215R71A224MA11#
	6.3Vdc	X7R	0.47μF	±20%	LLL215R70J474MA11#

T max.	Rated Voltage	TC Code	Cap.	Tol.	Part Number
0.5mm	4Vdc	X7S	1.0μF	±20%	LLL215C70G105MA11#
0.7mm	50Vdc	X7R	10000pF	±20%	LLL216R71H103MA01#
			22000pF	±20%	LLL216R71H223MA01#
	25Vdc	X7R	47000pF	±20%	LLL216R71E473MA01#
			0.1μF	±20%	LLL216R71E104MA01#
10Vdc	X7R	0.22μF	±20%	LLL216R71A224MA01#	
0.95mm	16Vdc	X7R	0.22μF	±20%	LLL219R71C224MA01#
	10Vdc	X7R	0.47μF	±20%	LLL219R71A474MA01#
			1.0μF	±20%	LLL219R71A105MA01#
4Vdc	X7S	2.2μF	±20%	LLL219C70G225MA01#	

### ■ 1.6×3.2mm

T max.	Rated Voltage	TC Code	Cap.	Tol.	Part Number
0.5mm	50Vdc	X7R	10000pF	±20%	LLL315R71H103MA11#
			22000pF	±20%	LLL315R71H223MA11#
			25Vdc	X7R	47000pF
	16Vdc	X7R	0.1μF	±20%	LLL315R71E104MA11#
			0.22μF	±20%	LLL315R71C224MA11#
			10Vdc	X7R	0.47μF
0.8mm	50Vdc	X7R	10000pF	±20%	LLL317R71H103MA01#
			22000pF	±20%	LLL317R71H223MA01#
			47000pF	±20%	LLL317R71H473MA01#
	25Vdc	X7R	0.1μF	±20%	LLL317R71E104MA01#
	16Vdc	X7R	0.22μF	±20%	LLL317R71C224MA01#
			0.47μF	±20%	LLL317R71C474MA01#
	10Vdc	X7R	1.0μF	±20%	LLL317R71A105MA01#
	6.3Vdc	X7R	2.2μF	±20%	LLL317R70J225MA01#
	1.25mm	50Vdc	X7R	0.1μF	±20%
25Vdc				X7R	0.22μF
0.47μF		±20%	LLL31MR71E474MA01#		
16Vdc		X7R	1.0μF	±20%	LLL31MR71C105MA01#
10Vdc		X7R	2.2μF	±20%	LLL31MR71A225MA01#
6.3Vdc		X7R	4.7μF	±20%	LLL31MR70J475MA01#
X5R	10μF		±20%	LLL31MR60J106ME01#	

## LLR Series High Dielectric Constant Type Low ESL Part Number List

### ■ 0.8×1.6mm

T max.	Rated Voltage	TC Code	Cap.	Tol.	ESR	Part Number
0.55mm	4Vdc	X7S	1.0μF	±20%	100mΩ	LLR185C70G105ME01#
				±20%	220mΩ	LLR185C70G105ME03#
				±20%	470mΩ	LLR185C70G105ME05#
				±20%	1000mΩ	LLR185C70G105ME07#

Part number # indicates the package specification code.

## LLA Series High Dielectric Constant Type Low ESL Part Number List

### ■ 1.6×0.8mm

T max.	Rated Voltage	TC Code	Cap.	Tol.	Part Number
0.55mm	4Vdc	X7S	0.1μF	±20%	LLA185C70G104MA01#
			0.22μF	±20%	LLA185C70G224MA01#
			0.47μF	±20%	LLA185C70G474MA01#
			1.0μF	±20%	LLA185C70G105ME01#
			2.2μF	±20%	LLA185C70G225ME16#

### ■ 2.0×1.25mm

T max.	Rated Voltage	TC Code	Cap.	Tol.	Part Number	
0.55mm	25Vdc	X7R	10000pF	±20%	LLA215R71E103MA14#	
			22000pF	±20%	LLA215R71E223MA14#	
	16Vdc	X7R	47000pF	±20%	LLA215R71C473MA14#	
			0.1μF	±20%	LLA215R71C104MA14#	
	10Vdc	X7R	0.22μF	±20%	LLA215R71A224MA14#	
	6.3Vdc	X7R	0.47μF	±20%	LLA215R70J474MA14#	
	4Vdc	X7S	1.0μF	±20%	LLA215C70G105MA14#	
			2.2μF	±20%	LLA215C70G225ME11#	
			4.7μF	±20%	LLA215C70G475ME19#	
	0.95mm	25Vdc	X7R	10000pF	±20%	LLA219R71E103MA01#

T max.	Rated Voltage	TC Code	Cap.	Tol.	Part Number
0.95mm	25Vdc	X7R	22000pF	±20%	LLA219R71E223MA01#
			47000pF	±20%	LLA219R71E473MA01#
	16Vdc	X7R	0.1μF	±20%	LLA219R71C104MA01#
			0.22μF	±20%	LLA219R71C224MA01#
	10Vdc	X7R	0.47μF	±20%	LLA219R71A474MA01#
	6.3Vdc	X7R	1.0μF	±20%	LLA219R70J105MA01#
	4Vdc	X7S	2.2μF	±20%	LLA219C70G225MA01#
			4.7μF	±20%	LLA219C70G475ME01#

### ■ 3.2×1.6mm

T max.	Rated Voltage	TC Code	Cap.	Tol.	Part Number
0.55mm	16Vdc	X7R	0.22μF	±20%	LLA315R71C224MA14#
			0.47μF	±20%	LLA315R71A474MA14#
	6.3Vdc	X7R	1.0μF	±20%	LLA315R70J105MA14#
			2.2μF	±20%	LLA315R70J225MA14#
0.95mm	16Vdc	X7R	0.47μF	±20%	LLA319R71C474MA01#
	10Vdc	X7R	1.0μF	±20%	LLA319R71A105MA01#
1.25mm	16Vdc	X7R	1.0μF	±20%	LLA31MR71C105MA01#
	10Vdc	X7R	2.2μF	±20%	LLA31MR71A225MA01#

## LLM Series High Dielectric Constant Type Low ESL Part Number List

### ■ 2.0×1.25mm

T max.	Rated Voltage	TC Code	Cap.	Tol.	Part Number
0.55mm	25Vdc	X7R	10000pF	±20%	LLM215R71E103MA11#
			22000pF	±20%	LLM215R71E223MA11#
	16Vdc	X7R	47000pF	±20%	LLM215R71C473MA11#
			0.1μF	±20%	LLM215R71C104MA11#
	6.3Vdc	X7R	0.22μF	±20%	LLM215R70J224MA11#
			0.47μF	±20%	LLM215R70J474MA11#
	4Vdc	X7S	1.0μF	±20%	LLM215C70G105MA11#
			2.2μF	±20%	LLM215C70G225ME11#

### ■ 3.2×1.6mm

T max.	Rated Voltage	TC Code	Cap.	Tol.	Part Number
0.55mm	16Vdc	X7R	0.1μF	±20%	LLM315R71C104MA11#
			0.22μF	±20%	LLM315R71C224MA11#
	10Vdc	X7R	0.47μF	±20%	LLM315R71A474MA11#
	6.3Vdc	X7R	2.2μF	±20%	LLM315R70J225MA11#

For General Purpose GRM Series  
 Capacitor Array GNM Series  
 Low ESL LLM Series  
 High-Q Type GJM Series  
 High Frequency GQM Series  
 Monolithic Microchip GMA Series  
 For Bonding GMD Series  
 Product Information

## Chip Monolithic Ceramic Capacitors

# High-Q Type GJM Series

HiQ

Contributes to improvements in the reduction of power consumption and processing yield by HiQ or low ESR.

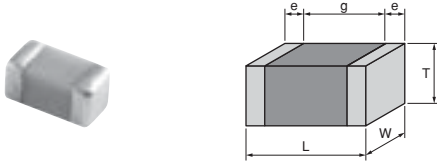

- 1 Ideal for high-frequency decoupling applications.
- 2 HiQ and low ESR in VHF, UHF and microwave frequency bands.
- 3 Compatible to tight tolerances.

For General Purpose  
GRM Series

Capacitor Array  
GMM Series

Low ESL  
LLC Series

High-Q Type  
GJM Series

High Frequency  
GQM Series

Monolithic Microchip  
GMA Series

For Bonding  
GMD Series

Product Information

# GJM Series Temperature Compensating Type HiQ Part Number List

■ 0.4x0.2mm Ultra-compact

T max.	Rated Voltage	TC Code	Cap.	Tol.	Part Number
0.22mm	16Vdc	C0G	0.2pF	±0.05pF	GJM0225C1CR20WB01#
				±0.1pF	GJM0225C1CR20BB01#
			0.3pF	±0.05pF	GJM0225C1CR30WB01#
				±0.1pF	GJM0225C1CR30BB01#
			0.4pF	±0.05pF	GJM0225C1CR40WB01#
				±0.1pF	GJM0225C1CR40BB01#
			0.5pF	±0.05pF	GJM0225C1CR50WB01#
				±0.1pF	GJM0225C1CR50BB01#
			0.6pF	±0.05pF	GJM0225C1CR60WB01#
				±0.1pF	GJM0225C1CR60BB01#
			0.7pF	±0.05pF	GJM0225C1CR70WB01#
				±0.1pF	GJM0225C1CR70BB01#
			0.8pF	±0.05pF	GJM0225C1CR80WB01#
				±0.1pF	GJM0225C1CR80BB01#
			0.9pF	±0.05pF	GJM0225C1CR90WB01#
				±0.1pF	GJM0225C1CR90BB01#
			1.0pF	±0.05pF	GJM0225C1C1R0WB01#
				±0.1pF	GJM0225C1C1R0BB01#
				±0.25pF	GJM0225C1C1R0CB01#
			1.1pF	±0.05pF	GJM0225C1C1R1WB01#
				±0.1pF	GJM0225C1C1R1BB01#
				±0.25pF	GJM0225C1C1R1CB01#
			1.2pF	±0.05pF	GJM0225C1C1R2WB01#
				±0.1pF	GJM0225C1C1R2BB01#
				±0.25pF	GJM0225C1C1R2CB01#
			1.3pF	±0.05pF	GJM0225C1C1R3WB01#
				±0.1pF	GJM0225C1C1R3BB01#
				±0.25pF	GJM0225C1C1R3CB01#
			1.4pF	±0.05pF	GJM0225C1C1R4WB01#
				±0.1pF	GJM0225C1C1R4BB01#
				±0.25pF	GJM0225C1C1R4CB01#
			1.5pF	±0.05pF	GJM0225C1C1R5WB01#
				±0.1pF	GJM0225C1C1R5BB01#
				±0.25pF	GJM0225C1C1R5CB01#
			1.6pF	±0.05pF	GJM0225C1C1R6WB01#
				±0.1pF	GJM0225C1C1R6BB01#
				±0.25pF	GJM0225C1C1R6CB01#
			1.7pF	±0.05pF	GJM0225C1C1R7WB01#
				±0.1pF	GJM0225C1C1R7BB01#
				±0.25pF	GJM0225C1C1R7CB01#
			1.8pF	±0.05pF	GJM0225C1C1R8WB01#
				±0.1pF	GJM0225C1C1R8BB01#
				±0.25pF	GJM0225C1C1R8CB01#
			1.9pF	±0.05pF	GJM0225C1C1R9WB01#
				±0.1pF	GJM0225C1C1R9BB01#
				±0.25pF	GJM0225C1C1R9CB01#
			2.0pF	±0.05pF	GJM0225C1C2R0WB01#
				±0.1pF	GJM0225C1C2R0BB01#
±0.25pF	GJM0225C1C2R0CB01#				
2.1pF	±0.05pF	GJM0225C1C2R1WB01#			
	±0.1pF	GJM0225C1C2R1BB01#			
	±0.25pF	GJM0225C1C2R1CB01#			

T max.	Rated Voltage	TC Code	Cap.	Tol.	Part Number
0.22mm	16Vdc	C0G	2.2pF	±0.05pF	GJM0225C1C2R2WB01#
				±0.1pF	GJM0225C1C2R2BB01#
				±0.25pF	GJM0225C1C2R2CB01#
			2.3pF	±0.05pF	GJM0225C1C2R3WB01#
				±0.1pF	GJM0225C1C2R3BB01#
				±0.25pF	GJM0225C1C2R3CB01#
			2.4pF	±0.05pF	GJM0225C1C2R4WB01#
				±0.1pF	GJM0225C1C2R4BB01#
				±0.25pF	GJM0225C1C2R4CB01#
			2.5pF	±0.05pF	GJM0225C1C2R5WB01#
				±0.1pF	GJM0225C1C2R5BB01#
				±0.25pF	GJM0225C1C2R5CB01#
			2.6pF	±0.05pF	GJM0225C1C2R6WB01#
				±0.1pF	GJM0225C1C2R6BB01#
				±0.25pF	GJM0225C1C2R6CB01#
			2.7pF	±0.05pF	GJM0225C1C2R7WB01#
				±0.1pF	GJM0225C1C2R7BB01#
				±0.25pF	GJM0225C1C2R7CB01#
			2.8pF	±0.05pF	GJM0225C1C2R8WB01#
				±0.1pF	GJM0225C1C2R8BB01#
				±0.25pF	GJM0225C1C2R8CB01#
			2.9pF	±0.05pF	GJM0225C1C2R9WB01#
				±0.1pF	GJM0225C1C2R9BB01#
				±0.25pF	GJM0225C1C2R9CB01#
			3.0pF	±0.05pF	GJM0225C1C3R0WB01#
				±0.1pF	GJM0225C1C3R0BB01#
				±0.25pF	GJM0225C1C3R0CB01#
			3.1pF	±0.05pF	GJM0225C1C3R1WB01#
				±0.1pF	GJM0225C1C3R1BB01#
				±0.25pF	GJM0225C1C3R1CB01#
			3.2pF	±0.05pF	GJM0225C1C3R2WB01#
				±0.1pF	GJM0225C1C3R2BB01#
				±0.25pF	GJM0225C1C3R2CB01#
			3.3pF	±0.05pF	GJM0225C1C3R3WB01#
				±0.1pF	GJM0225C1C3R3BB01#
				±0.25pF	GJM0225C1C3R3CB01#
			3.4pF	±0.05pF	GJM0225C1C3R4WB01#
				±0.1pF	GJM0225C1C3R4BB01#
				±0.25pF	GJM0225C1C3R4CB01#
			3.5pF	±0.05pF	GJM0225C1C3R5WB01#
				±0.1pF	GJM0225C1C3R5BB01#
				±0.25pF	GJM0225C1C3R5CB01#
			3.6pF	±0.05pF	GJM0225C1C3R6WB01#
				±0.1pF	GJM0225C1C3R6BB01#
				±0.25pF	GJM0225C1C3R6CB01#
			3.7pF	±0.05pF	GJM0225C1C3R7WB01#
				±0.1pF	GJM0225C1C3R7BB01#
				±0.25pF	GJM0225C1C3R7CB01#
3.8pF	±0.05pF	GJM0225C1C3R8WB01#			
	±0.1pF	GJM0225C1C3R8BB01#			
	±0.25pF	GJM0225C1C3R8CB01#			
3.9pF	±0.05pF	GJM0225C1C3R9WB01#			
	±0.1pF	GJM0225C1C3R9BB01#			
	±0.25pF	GJM0225C1C3R9CB01#			

For General Purpose GRM Series  
 Capacitor Array GNM Series  
 Low ESL LL Series  
 High-Q Type GJM Series  
 High Frequency GQM Series  
 Monolithic Microchip GMA Series  
 For Bonding GMD Series  
 Product Information

Part number # indicates the package specification code.



## GJM Series Temperature Compensating Type HiQ Part Number List

(→ ■ 0.4x0.2mm)

T max.	Rated Voltage	TC Code	Cap.	Tol.	Part Number
0.22mm	16Vdc	C0G	4.0pF	±0.05pF	<b>GJM0225C1C4R0WB01#</b>
				±0.1pF	<b>GJM0225C1C4R0BB01#</b>
				±0.25pF	<b>GJM0225C1C4R0CB01#</b>
			4.1pF	±0.05pF	<b>GJM0225C1C4R1WB01#</b>
				±0.1pF	<b>GJM0225C1C4R1BB01#</b>
				±0.25pF	<b>GJM0225C1C4R1CB01#</b>
			4.2pF	±0.05pF	<b>GJM0225C1C4R2WB01#</b>
				±0.1pF	<b>GJM0225C1C4R2BB01#</b>
				±0.25pF	<b>GJM0225C1C4R2CB01#</b>
			4.3pF	±0.05pF	<b>GJM0225C1C4R3WB01#</b>
				±0.1pF	<b>GJM0225C1C4R3BB01#</b>
				±0.25pF	<b>GJM0225C1C4R3CB01#</b>
			4.4pF	±0.05pF	<b>GJM0225C1C4R4WB01#</b>
				±0.1pF	<b>GJM0225C1C4R4BB01#</b>
				±0.25pF	<b>GJM0225C1C4R4CB01#</b>
			4.5pF	±0.05pF	<b>GJM0225C1C4R5WB01#</b>
				±0.1pF	<b>GJM0225C1C4R5BB01#</b>
				±0.25pF	<b>GJM0225C1C4R5CB01#</b>
			4.6pF	±0.05pF	<b>GJM0225C1C4R6WB01#</b>
				±0.1pF	<b>GJM0225C1C4R6BB01#</b>
				±0.25pF	<b>GJM0225C1C4R6CB01#</b>
			4.7pF	±0.05pF	<b>GJM0225C1C4R7WB01#</b>
				±0.1pF	<b>GJM0225C1C4R7BB01#</b>
				±0.25pF	<b>GJM0225C1C4R7CB01#</b>
			4.8pF	±0.05pF	<b>GJM0225C1C4R8WB01#</b>
				±0.1pF	<b>GJM0225C1C4R8BB01#</b>
				±0.25pF	<b>GJM0225C1C4R8CB01#</b>
			4.9pF	±0.05pF	<b>GJM0225C1C4R9WB01#</b>
				±0.1pF	<b>GJM0225C1C4R9BB01#</b>
				±0.25pF	<b>GJM0225C1C4R9CB01#</b>
			5.0pF	±0.05pF	<b>GJM0225C1C5R0WB01#</b>
				±0.1pF	<b>GJM0225C1C5R0BB01#</b>
				±0.25pF	<b>GJM0225C1C5R0CB01#</b>
			5.1pF	±0.05pF	<b>GJM0225C1C5R1WB01#</b>
				±0.1pF	<b>GJM0225C1C5R1BB01#</b>
				±0.25pF	<b>GJM0225C1C5R1CB01#</b>
				±0.5pF	<b>GJM0225C1C5R1DB01#</b>
			5.2pF	±0.05pF	<b>GJM0225C1C5R2WB01#</b>
				±0.1pF	<b>GJM0225C1C5R2BB01#</b>
				±0.25pF	<b>GJM0225C1C5R2CB01#</b>
				±0.5pF	<b>GJM0225C1C5R2DB01#</b>
			5.3pF	±0.05pF	<b>GJM0225C1C5R3WB01#</b>
				±0.1pF	<b>GJM0225C1C5R3BB01#</b>
				±0.25pF	<b>GJM0225C1C5R3CB01#</b>
				±0.5pF	<b>GJM0225C1C5R3DB01#</b>
			5.4pF	±0.05pF	<b>GJM0225C1C5R4WB01#</b>
				±0.1pF	<b>GJM0225C1C5R4BB01#</b>
				±0.25pF	<b>GJM0225C1C5R4CB01#</b>
±0.5pF	<b>GJM0225C1C5R4DB01#</b>				
5.5pF	±0.05pF	<b>GJM0225C1C5R5WB01#</b>			
	±0.1pF	<b>GJM0225C1C5R5BB01#</b>			
	±0.25pF	<b>GJM0225C1C5R5CB01#</b>			
	±0.5pF	<b>GJM0225C1C5R5DB01#</b>			
5.6pF	±0.05pF	<b>GJM0225C1C5R6WB01#</b>			

T max.	Rated Voltage	TC Code	Cap.	Tol.	Part Number
0.22mm	16Vdc	C0G	5.6pF	±0.1pF	<b>GJM0225C1C5R6BB01#</b>
				±0.25pF	<b>GJM0225C1C5R6CB01#</b>
				±0.5pF	<b>GJM0225C1C5R6DB01#</b>
			5.7pF	±0.05pF	<b>GJM0225C1C5R7WB01#</b>
				±0.1pF	<b>GJM0225C1C5R7BB01#</b>
				±0.25pF	<b>GJM0225C1C5R7CB01#</b>
			5.8pF	±0.05pF	<b>GJM0225C1C5R8WB01#</b>
				±0.1pF	<b>GJM0225C1C5R8BB01#</b>
				±0.25pF	<b>GJM0225C1C5R8CB01#</b>
			5.9pF	±0.05pF	<b>GJM0225C1C5R9WB01#</b>
				±0.1pF	<b>GJM0225C1C5R9BB01#</b>
				±0.25pF	<b>GJM0225C1C5R9CB01#</b>
			6.0pF	±0.05pF	<b>GJM0225C1C6R0WB01#</b>
				±0.1pF	<b>GJM0225C1C6R0BB01#</b>
				±0.25pF	<b>GJM0225C1C6R0CB01#</b>
			6.1pF	±0.05pF	<b>GJM0225C1C6R1WB01#</b>
				±0.1pF	<b>GJM0225C1C6R1BB01#</b>
				±0.25pF	<b>GJM0225C1C6R1CB01#</b>
			6.2pF	±0.05pF	<b>GJM0225C1C6R2WB01#</b>
				±0.1pF	<b>GJM0225C1C6R2BB01#</b>
				±0.25pF	<b>GJM0225C1C6R2CB01#</b>
			6.3pF	±0.05pF	<b>GJM0225C1C6R3WB01#</b>
				±0.1pF	<b>GJM0225C1C6R3BB01#</b>
				±0.25pF	<b>GJM0225C1C6R3CB01#</b>
			6.4pF	±0.05pF	<b>GJM0225C1C6R4WB01#</b>
				±0.1pF	<b>GJM0225C1C6R4BB01#</b>
				±0.25pF	<b>GJM0225C1C6R4CB01#</b>
			6.5pF	±0.05pF	<b>GJM0225C1C6R5WB01#</b>
				±0.1pF	<b>GJM0225C1C6R5BB01#</b>
				±0.25pF	<b>GJM0225C1C6R5CB01#</b>
			6.6pF	±0.05pF	<b>GJM0225C1C6R6WB01#</b>
				±0.1pF	<b>GJM0225C1C6R6BB01#</b>
				±0.25pF	<b>GJM0225C1C6R6CB01#</b>
			6.7pF	±0.05pF	<b>GJM0225C1C6R7WB01#</b>
				±0.1pF	<b>GJM0225C1C6R7BB01#</b>
				±0.25pF	<b>GJM0225C1C6R7CB01#</b>
			6.8pF	±0.05pF	<b>GJM0225C1C6R8WB01#</b>
				±0.1pF	<b>GJM0225C1C6R8BB01#</b>
				±0.25pF	<b>GJM0225C1C6R8CB01#</b>
			6.9pF	±0.05pF	<b>GJM0225C1C6R9WB01#</b>
				±0.1pF	<b>GJM0225C1C6R9BB01#</b>
				±0.25pF	<b>GJM0225C1C6R9CB01#</b>

Part number # indicates the package specification code.

For General Purpose GRM Series  
 Capacitor Array GNM Series  
 Low ESL LLI Series  
 High-Q Type GMI Series  
 High Frequency GQM Series  
 Monolithic Microchip GMA Series  
 For Bonding GMD Series  
 Product Information

## GJM Series Temperature Compensating Type HiQ Part Number List

(→ ■ 0.4x0.2mm)

T max.	Rated Voltage	TC Code	Cap.	Tol.	Part Number
0.22mm	16Vdc	C0G	6.9pF	±0.5pF	GJM0225C1C6R9DB01#
				7.0pF	±0.05pF
			±0.1pF		GJM0225C1C7R0BB01#
			±0.25pF		GJM0225C1C7R0CB01#
			±0.5pF		GJM0225C1C7R0DB01#
			7.1pF	±0.05pF	GJM0225C1C7R1WB01#
				±0.1pF	GJM0225C1C7R1BB01#
				±0.25pF	GJM0225C1C7R1CB01#
				±0.5pF	GJM0225C1C7R1DB01#
			7.2pF	±0.05pF	GJM0225C1C7R2WB01#
				±0.1pF	GJM0225C1C7R2BB01#
				±0.25pF	GJM0225C1C7R2CB01#
				±0.5pF	GJM0225C1C7R2DB01#
			7.3pF	±0.05pF	GJM0225C1C7R3WB01#
				±0.1pF	GJM0225C1C7R3BB01#
				±0.25pF	GJM0225C1C7R3CB01#
				±0.5pF	GJM0225C1C7R3DB01#
			7.4pF	±0.05pF	GJM0225C1C7R4WB01#
				±0.1pF	GJM0225C1C7R4BB01#
				±0.25pF	GJM0225C1C7R4CB01#
				±0.5pF	GJM0225C1C7R4DB01#
			7.5pF	±0.05pF	GJM0225C1C7R5WB01#
				±0.1pF	GJM0225C1C7R5BB01#
				±0.25pF	GJM0225C1C7R5CB01#
				±0.5pF	GJM0225C1C7R5DB01#
			7.6pF	±0.05pF	GJM0225C1C7R6WB01#
				±0.1pF	GJM0225C1C7R6BB01#
				±0.25pF	GJM0225C1C7R6CB01#
				±0.5pF	GJM0225C1C7R6DB01#
			7.7pF	±0.05pF	GJM0225C1C7R7WB01#
				±0.1pF	GJM0225C1C7R7BB01#
				±0.25pF	GJM0225C1C7R7CB01#
				±0.5pF	GJM0225C1C7R7DB01#
			7.8pF	±0.05pF	GJM0225C1C7R8WB01#
				±0.1pF	GJM0225C1C7R8BB01#
				±0.25pF	GJM0225C1C7R8CB01#
				±0.5pF	GJM0225C1C7R8DB01#
			7.9pF	±0.05pF	GJM0225C1C7R9WB01#
				±0.1pF	GJM0225C1C7R9BB01#
				±0.25pF	GJM0225C1C7R9CB01#
				±0.5pF	GJM0225C1C7R9DB01#
			8.0pF	±0.05pF	GJM0225C1C8R0WB01#
				±0.1pF	GJM0225C1C8R0BB01#
				±0.25pF	GJM0225C1C8R0CB01#
				±0.5pF	GJM0225C1C8R0DB01#
			8.1pF	±0.05pF	GJM0225C1C8R1WB01#
				±0.1pF	GJM0225C1C8R1BB01#
				±0.25pF	GJM0225C1C8R1CB01#
				±0.5pF	GJM0225C1C8R1DB01#
			8.2pF	±0.05pF	GJM0225C1C8R2WB01#
				±0.1pF	GJM0225C1C8R2BB01#
				±0.25pF	GJM0225C1C8R2CB01#
				±0.5pF	GJM0225C1C8R2DB01#
			8.3pF	±0.05pF	GJM0225C1C8R3WB01#

T max.	Rated Voltage	TC Code	Cap.	Tol.	Part Number
0.22mm	16Vdc	C0G	8.3pF	±0.1pF	GJM0225C1C8R3BB01#
				±0.25pF	GJM0225C1C8R3CB01#
				±0.5pF	GJM0225C1C8R3DB01#
			8.4pF	±0.05pF	GJM0225C1C8R4WB01#
				±0.1pF	GJM0225C1C8R4BB01#
				±0.25pF	GJM0225C1C8R4CB01#
			8.5pF	±0.05pF	GJM0225C1C8R5WB01#
				±0.1pF	GJM0225C1C8R5BB01#
				±0.25pF	GJM0225C1C8R5CB01#
			8.6pF	±0.05pF	GJM0225C1C8R6WB01#
				±0.1pF	GJM0225C1C8R6BB01#
				±0.25pF	GJM0225C1C8R6CB01#
			8.7pF	±0.05pF	GJM0225C1C8R7WB01#
				±0.1pF	GJM0225C1C8R7BB01#
				±0.25pF	GJM0225C1C8R7CB01#
			8.8pF	±0.05pF	GJM0225C1C8R8WB01#
				±0.1pF	GJM0225C1C8R8BB01#
				±0.25pF	GJM0225C1C8R8CB01#
			8.9pF	±0.05pF	GJM0225C1C8R9WB01#
				±0.1pF	GJM0225C1C8R9BB01#
				±0.25pF	GJM0225C1C8R9CB01#
			9.0pF	±0.05pF	GJM0225C1C9R0WB01#
				±0.1pF	GJM0225C1C9R0BB01#
				±0.25pF	GJM0225C1C9R0CB01#
			9.1pF	±0.05pF	GJM0225C1C9R1WB01#
				±0.1pF	GJM0225C1C9R1BB01#
				±0.25pF	GJM0225C1C9R1CB01#
			9.2pF	±0.05pF	GJM0225C1C9R2WB01#
				±0.1pF	GJM0225C1C9R2BB01#
				±0.25pF	GJM0225C1C9R2CB01#
			9.3pF	±0.05pF	GJM0225C1C9R3WB01#
				±0.1pF	GJM0225C1C9R3BB01#
				±0.25pF	GJM0225C1C9R3CB01#
			9.4pF	±0.05pF	GJM0225C1C9R4WB01#
				±0.1pF	GJM0225C1C9R4BB01#
				±0.25pF	GJM0225C1C9R4CB01#
			9.5pF	±0.05pF	GJM0225C1C9R5WB01#
				±0.1pF	GJM0225C1C9R5BB01#
				±0.25pF	GJM0225C1C9R5CB01#
			9.6pF	±0.05pF	GJM0225C1C9R6WB01#
				±0.1pF	GJM0225C1C9R6BB01#
				±0.25pF	GJM0225C1C9R6CB01#

For General Purpose GRM Series

Capacitor Array GNM Series

Low ESL LLM Series

High-Q Type GJM Series

High Frequency GQM Series

Monolithic Microchip GMA Series

For Bonding GMD Series

Product Information

Part number # indicates the package specification code.

## GJM Series Temperature Compensating Type HiQ Part Number List

(→ ■ 0.4x0.2mm)

T max.	Rated Voltage	TC Code	Cap.	Tol.	Part Number	
0.22mm	16Vdc	C0G	9.6pF	±0.5pF	<b>GJM0225C1C9R6DB01#</b>	
				±0.05pF	<b>GJM0225C1C9R7WB01#</b>	
					±0.1pF	<b>GJM0225C1C9R7BB01#</b>
					±0.25pF	<b>GJM0225C1C9R7CB01#</b>
				±0.5pF	<b>GJM0225C1C9R7DB01#</b>	
			9.8pF	±0.05pF	<b>GJM0225C1C9R8WB01#</b>	
				±0.1pF	<b>GJM0225C1C9R8BB01#</b>	
				±0.25pF	<b>GJM0225C1C9R8CB01#</b>	
				±0.5pF	<b>GJM0225C1C9R8DB01#</b>	
				9.9pF	±0.05pF	<b>GJM0225C1C9R9WB01#</b>
					±0.1pF	<b>GJM0225C1C9R9BB01#</b>
			±0.25pF		<b>GJM0225C1C9R9CB01#</b>	
			10pF	±2%	<b>GJM0225C1C100GB01#</b>	
				±5%	<b>GJM0225C1C100JB01#</b>	
				CK	0.2pF	±0.05pF
			±0.1pF			<b>GJM0224C1CR20BB01#</b>
			0.3pF		±0.05pF	<b>GJM0224C1CR30WB01#</b>
					±0.1pF	<b>GJM0224C1CR30BB01#</b>
			0.4pF		±0.05pF	<b>GJM0224C1CR40WB01#</b>
					±0.1pF	<b>GJM0224C1CR40BB01#</b>
			0.5pF		±0.05pF	<b>GJM0224C1CR50WB01#</b>
					±0.1pF	<b>GJM0224C1CR50BB01#</b>
			0.6pF		±0.05pF	<b>GJM0224C1CR60WB01#</b>
					±0.1pF	<b>GJM0224C1CR60BB01#</b>
			0.7pF		±0.05pF	<b>GJM0224C1CR70WB01#</b>
					±0.1pF	<b>GJM0224C1CR70BB01#</b>
			0.8pF		±0.05pF	<b>GJM0224C1CR80WB01#</b>
					±0.1pF	<b>GJM0224C1CR80BB01#</b>
			0.9pF		±0.05pF	<b>GJM0224C1CR90WB01#</b>
					±0.1pF	<b>GJM0224C1CR90BB01#</b>
		1.0pF	±0.05pF		<b>GJM0224C1C1R0WB01#</b>	
			±0.1pF		<b>GJM0224C1C1R0BB01#</b>	
			±0.25pF		<b>GJM0224C1C1R0CB01#</b>	
		1.1pF	±0.05pF		<b>GJM0224C1C1R1WB01#</b>	
			±0.1pF		<b>GJM0224C1C1R1BB01#</b>	
			±0.25pF		<b>GJM0224C1C1R1CB01#</b>	
		1.2pF	±0.05pF		<b>GJM0224C1C1R2WB01#</b>	
			±0.1pF		<b>GJM0224C1C1R2BB01#</b>	
			±0.25pF	<b>GJM0224C1C1R2CB01#</b>		
		1.3pF	±0.05pF	<b>GJM0224C1C1R3WB01#</b>		
			±0.1pF	<b>GJM0224C1C1R3BB01#</b>		
			±0.25pF	<b>GJM0224C1C1R3CB01#</b>		
		1.4pF	±0.05pF	<b>GJM0224C1C1R4WB01#</b>		
			±0.1pF	<b>GJM0224C1C1R4BB01#</b>		
			±0.25pF	<b>GJM0224C1C1R4CB01#</b>		
		1.5pF	±0.05pF	<b>GJM0224C1C1R5WB01#</b>		
			±0.1pF	<b>GJM0224C1C1R5BB01#</b>		
			±0.25pF	<b>GJM0224C1C1R5CB01#</b>		
		1.6pF	±0.05pF	<b>GJM0224C1C1R6WB01#</b>		
			±0.1pF	<b>GJM0224C1C1R6BB01#</b>		
			±0.25pF	<b>GJM0224C1C1R6CB01#</b>		
		1.7pF	±0.05pF	<b>GJM0224C1C1R7WB01#</b>		
			±0.1pF	<b>GJM0224C1C1R7BB01#</b>		

T max.	Rated Voltage	TC Code	Cap.	Tol.	Part Number	
0.22mm	16Vdc	CK	1.7pF	±0.25pF	<b>GJM0224C1C1R7CB01#</b>	
				±0.05pF	<b>GJM0224C1C1R8WB01#</b>	
					±0.1pF	<b>GJM0224C1C1R8BB01#</b>
					±0.25pF	<b>GJM0224C1C1R8CB01#</b>
				1.9pF	±0.05pF	<b>GJM0224C1C1R9WB01#</b>
			±0.1pF		<b>GJM0224C1C1R9BB01#</b>	
			±0.25pF		<b>GJM0224C1C1R9CB01#</b>	
			2.0pF		±0.05pF	<b>GJM0224C1C2R0WB01#</b>
					±0.1pF	<b>GJM0224C1C2R0BB01#</b>
					±0.25pF	<b>GJM0224C1C2R0CB01#</b>
			CJ	2.1pF	±0.05pF	<b>GJM0223C1C2R1WB01#</b>
					±0.1pF	<b>GJM0223C1C2R1BB01#</b>
					±0.25pF	<b>GJM0223C1C2R1CB01#</b>
			2.2pF	±0.05pF	<b>GJM0223C1C2R2WB01#</b>	
				±0.1pF	<b>GJM0223C1C2R2BB01#</b>	
				±0.25pF	<b>GJM0223C1C2R2CB01#</b>	
			2.3pF	±0.05pF	<b>GJM0223C1C2R3WB01#</b>	
				±0.1pF	<b>GJM0223C1C2R3BB01#</b>	
				±0.25pF	<b>GJM0223C1C2R3CB01#</b>	
			2.4pF	±0.05pF	<b>GJM0223C1C2R4WB01#</b>	
				±0.1pF	<b>GJM0223C1C2R4BB01#</b>	
				±0.25pF	<b>GJM0223C1C2R4CB01#</b>	
			2.5pF	±0.05pF	<b>GJM0223C1C2R5WB01#</b>	
				±0.1pF	<b>GJM0223C1C2R5BB01#</b>	
				±0.25pF	<b>GJM0223C1C2R5CB01#</b>	
			2.6pF	±0.05pF	<b>GJM0223C1C2R6WB01#</b>	
				±0.1pF	<b>GJM0223C1C2R6BB01#</b>	
				±0.25pF	<b>GJM0223C1C2R6CB01#</b>	
			2.7pF	±0.05pF	<b>GJM0223C1C2R7WB01#</b>	
				±0.1pF	<b>GJM0223C1C2R7BB01#</b>	
		±0.25pF		<b>GJM0223C1C2R7CB01#</b>		
		2.8pF	±0.05pF	<b>GJM0223C1C2R8WB01#</b>		
			±0.1pF	<b>GJM0223C1C2R8BB01#</b>		
			±0.25pF	<b>GJM0223C1C2R8CB01#</b>		
		2.9pF	±0.05pF	<b>GJM0223C1C2R9WB01#</b>		
			±0.1pF	<b>GJM0223C1C2R9BB01#</b>		
			±0.25pF	<b>GJM0223C1C2R9CB01#</b>		
		3.0pF	±0.05pF	<b>GJM0223C1C3R0WB01#</b>		
			±0.1pF	<b>GJM0223C1C3R0BB01#</b>		
			±0.25pF	<b>GJM0223C1C3R0CB01#</b>		
		3.1pF	±0.05pF	<b>GJM0223C1C3R1WB01#</b>		
			±0.1pF	<b>GJM0223C1C3R1BB01#</b>		
			±0.25pF	<b>GJM0223C1C3R1CB01#</b>		
		3.2pF	±0.05pF	<b>GJM0223C1C3R2WB01#</b>		
			±0.1pF	<b>GJM0223C1C3R2BB01#</b>		
			±0.25pF	<b>GJM0223C1C3R2CB01#</b>		
		3.3pF	±0.05pF	<b>GJM0223C1C3R3WB01#</b>		
			±0.1pF	<b>GJM0223C1C3R3BB01#</b>		
			±0.25pF	<b>GJM0223C1C3R3CB01#</b>		
		3.4pF	±0.05pF	<b>GJM0223C1C3R4WB01#</b>		
			±0.1pF	<b>GJM0223C1C3R4BB01#</b>		
			±0.25pF	<b>GJM0223C1C3R4CB01#</b>		
		3.5pF	±0.05pF	<b>GJM0223C1C3R5WB01#</b>		
			±0.1pF	<b>GJM0223C1C3R5BB01#</b>		

Part number # indicates the package specification code.

For General Purpose GRM Series  
 Capacitor Array GNM Series  
 Low ESL LLD Series  
 High-Q Type GMI Series  
 High Frequency GQM Series  
 Monolithic Microchip GMA Series  
 For Bonding GMD Series  
 Product Information

## GJM Series Temperature Compensating Type HiQ Part Number List

(→ ■ 0.4x0.2mm)

T max.	Rated Voltage	TC Code	Cap.	Tol.	Part Number		
0.22mm	16Vdc	CJ	3.5pF	±0.25pF	GJM0223C1C3R5CB01#		
				±0.05pF	GJM0223C1C3R6WB01#		
				±0.1pF	GJM0223C1C3R6BB01#		
				±0.25pF	GJM0223C1C3R6CB01#		
			3.7pF	±0.05pF	GJM0223C1C3R7WB01#		
				±0.1pF	GJM0223C1C3R7BB01#		
				±0.25pF	GJM0223C1C3R7CB01#		
				3.8pF	±0.05pF	GJM0223C1C3R8WB01#	
					±0.1pF	GJM0223C1C3R8BB01#	
					±0.25pF	GJM0223C1C3R8CB01#	
			3.9pF	±0.05pF	GJM0223C1C3R9WB01#		
				±0.1pF	GJM0223C1C3R9BB01#		
				±0.25pF	GJM0223C1C3R9CB01#		
			CH	4.0pF	±0.05pF	GJM0222C1C4R0WB01#	
					±0.1pF	GJM0222C1C4R0BB01#	
					±0.25pF	GJM0222C1C4R0CB01#	
					4.1pF	±0.05pF	GJM0222C1C4R1WB01#
						±0.1pF	GJM0222C1C4R1BB01#
						±0.25pF	GJM0222C1C4R1CB01#
					4.2pF	±0.05pF	GJM0222C1C4R2WB01#
						±0.1pF	GJM0222C1C4R2BB01#
						±0.25pF	GJM0222C1C4R2CB01#
					4.3pF	±0.05pF	GJM0222C1C4R3WB01#
						±0.1pF	GJM0222C1C4R3BB01#
		±0.25pF				GJM0222C1C4R3CB01#	
		4.4pF			±0.05pF	GJM0222C1C4R4WB01#	
					±0.1pF	GJM0222C1C4R4BB01#	
					±0.25pF	GJM0222C1C4R4CB01#	
		4.5pF			±0.05pF	GJM0222C1C4R5WB01#	
					±0.1pF	GJM0222C1C4R5BB01#	
					±0.25pF	GJM0222C1C4R5CB01#	
		4.6pF			±0.05pF	GJM0222C1C4R6WB01#	
					±0.1pF	GJM0222C1C4R6BB01#	
					±0.25pF	GJM0222C1C4R6CB01#	
		4.7pF			±0.05pF	GJM0222C1C4R7WB01#	
					±0.1pF	GJM0222C1C4R7BB01#	
					±0.25pF	GJM0222C1C4R7CB01#	
		4.8pF		±0.05pF	GJM0222C1C4R8WB01#		
				±0.1pF	GJM0222C1C4R8BB01#		
				±0.25pF	GJM0222C1C4R8CB01#		
		4.9pF		±0.05pF	GJM0222C1C4R9WB01#		
				±0.1pF	GJM0222C1C4R9BB01#		
				±0.25pF	GJM0222C1C4R9CB01#		
		5.0pF		±0.05pF	GJM0222C1C5R0WB01#		
				±0.1pF	GJM0222C1C5R0BB01#		
				±0.25pF	GJM0222C1C5R0CB01#		
		5.1pF		±0.05pF	GJM0222C1C5R1WB01#		
				±0.1pF	GJM0222C1C5R1BB01#		
±0.25pF	GJM0222C1C5R1CB01#						
±0.5pF	GJM0222C1C5R1DB01#						
5.2pF	±0.05pF	GJM0222C1C5R2WB01#					
	±0.1pF	GJM0222C1C5R2BB01#					
	±0.25pF	GJM0222C1C5R2CB01#					
	±0.5pF	GJM0222C1C5R2DB01#					

T max.	Rated Voltage	TC Code	Cap.	Tol.	Part Number
0.22mm	16Vdc	CH	5.3pF	±0.05pF	GJM0222C1C5R3WB01#
				±0.1pF	GJM0222C1C5R3BB01#
				±0.25pF	GJM0222C1C5R3CB01#
				±0.5pF	GJM0222C1C5R3DB01#
			5.4pF	±0.05pF	GJM0222C1C5R4WB01#
				±0.1pF	GJM0222C1C5R4BB01#
				±0.25pF	GJM0222C1C5R4CB01#
				±0.5pF	GJM0222C1C5R4DB01#
			5.5pF	±0.05pF	GJM0222C1C5R5WB01#
				±0.1pF	GJM0222C1C5R5BB01#
				±0.25pF	GJM0222C1C5R5CB01#
			5.6pF	±0.05pF	GJM0222C1C5R6WB01#
				±0.1pF	GJM0222C1C5R6BB01#
				±0.25pF	GJM0222C1C5R6CB01#
			5.7pF	±0.05pF	GJM0222C1C5R7WB01#
				±0.1pF	GJM0222C1C5R7BB01#
				±0.25pF	GJM0222C1C5R7CB01#
			5.8pF	±0.05pF	GJM0222C1C5R8WB01#
				±0.1pF	GJM0222C1C5R8BB01#
				±0.25pF	GJM0222C1C5R8CB01#
			5.9pF	±0.05pF	GJM0222C1C5R9WB01#
				±0.1pF	GJM0222C1C5R9BB01#
				±0.25pF	GJM0222C1C5R9CB01#
			6.0pF	±0.05pF	GJM0222C1C6R0WB01#
				±0.1pF	GJM0222C1C6R0BB01#
				±0.25pF	GJM0222C1C6R0CB01#
			6.1pF	±0.05pF	GJM0222C1C6R1WB01#
				±0.1pF	GJM0222C1C6R1BB01#
				±0.25pF	GJM0222C1C6R1CB01#
			6.2pF	±0.05pF	GJM0222C1C6R2WB01#
				±0.1pF	GJM0222C1C6R2BB01#
				±0.25pF	GJM0222C1C6R2CB01#
			6.3pF	±0.05pF	GJM0222C1C6R3WB01#
				±0.1pF	GJM0222C1C6R3BB01#
				±0.25pF	GJM0222C1C6R3CB01#
			6.4pF	±0.05pF	GJM0222C1C6R4WB01#
				±0.1pF	GJM0222C1C6R4BB01#
				±0.25pF	GJM0222C1C6R4CB01#
			6.5pF	±0.05pF	GJM0222C1C6R5WB01#
				±0.1pF	GJM0222C1C6R5BB01#
				±0.25pF	GJM0222C1C6R5CB01#
			6.6pF	±0.05pF	GJM0222C1C6R6WB01#
				±0.1pF	GJM0222C1C6R6BB01#

For General Purpose GRM Series

Capacitor Array GNM Series

Low ESL LLM Series

High-Q Type GJM Series

High Frequency GQM Series

Monolithic Microchip GMA Series

For Bonding GMD Series

Product Information

Part number # indicates the package specification code.



## GJM Series Temperature Compensating Type HiQ Part Number List

(→ ■ 0.4x0.2mm)

T max.	Rated Voltage	TC Code	Cap.	Tol.	Part Number
0.22mm	16Vdc	CH	6.6pF	±0.25pF	<b>GJM0222C1C6R6CB01#</b>
				±0.5pF	<b>GJM0222C1C6R6DB01#</b>
			6.7pF	±0.05pF	<b>GJM0222C1C6R7WB01#</b>
				±0.1pF	<b>GJM0222C1C6R7BB01#</b>
				±0.25pF	<b>GJM0222C1C6R7CB01#</b>
				±0.5pF	<b>GJM0222C1C6R7DB01#</b>
			6.8pF	±0.05pF	<b>GJM0222C1C6R8WB01#</b>
				±0.1pF	<b>GJM0222C1C6R8BB01#</b>
				±0.25pF	<b>GJM0222C1C6R8CB01#</b>
				±0.5pF	<b>GJM0222C1C6R8DB01#</b>
			6.9pF	±0.05pF	<b>GJM0222C1C6R9WB01#</b>
				±0.1pF	<b>GJM0222C1C6R9BB01#</b>
				±0.25pF	<b>GJM0222C1C6R9CB01#</b>
				±0.5pF	<b>GJM0222C1C6R9DB01#</b>
			7.0pF	±0.05pF	<b>GJM0222C1C7R0WB01#</b>
				±0.1pF	<b>GJM0222C1C7R0BB01#</b>
				±0.25pF	<b>GJM0222C1C7R0CB01#</b>
				±0.5pF	<b>GJM0222C1C7R0DB01#</b>
			7.1pF	±0.05pF	<b>GJM0222C1C7R1WB01#</b>
				±0.1pF	<b>GJM0222C1C7R1BB01#</b>
				±0.25pF	<b>GJM0222C1C7R1CB01#</b>
				±0.5pF	<b>GJM0222C1C7R1DB01#</b>
			7.2pF	±0.05pF	<b>GJM0222C1C7R2WB01#</b>
				±0.1pF	<b>GJM0222C1C7R2BB01#</b>
				±0.25pF	<b>GJM0222C1C7R2CB01#</b>
				±0.5pF	<b>GJM0222C1C7R2DB01#</b>
			7.3pF	±0.05pF	<b>GJM0222C1C7R3WB01#</b>
				±0.1pF	<b>GJM0222C1C7R3BB01#</b>
				±0.25pF	<b>GJM0222C1C7R3CB01#</b>
				±0.5pF	<b>GJM0222C1C7R3DB01#</b>
			7.4pF	±0.05pF	<b>GJM0222C1C7R4WB01#</b>
				±0.1pF	<b>GJM0222C1C7R4BB01#</b>
				±0.25pF	<b>GJM0222C1C7R4CB01#</b>
				±0.5pF	<b>GJM0222C1C7R4DB01#</b>
			7.5pF	±0.05pF	<b>GJM0222C1C7R5WB01#</b>
				±0.1pF	<b>GJM0222C1C7R5BB01#</b>
				±0.25pF	<b>GJM0222C1C7R5CB01#</b>
				±0.5pF	<b>GJM0222C1C7R5DB01#</b>
			7.6pF	±0.05pF	<b>GJM0222C1C7R6WB01#</b>
				±0.1pF	<b>GJM0222C1C7R6BB01#</b>
				±0.25pF	<b>GJM0222C1C7R6CB01#</b>
				±0.5pF	<b>GJM0222C1C7R6DB01#</b>
			7.7pF	±0.05pF	<b>GJM0222C1C7R7WB01#</b>
				±0.1pF	<b>GJM0222C1C7R7BB01#</b>
				±0.25pF	<b>GJM0222C1C7R7CB01#</b>
				±0.5pF	<b>GJM0222C1C7R7DB01#</b>
			7.8pF	±0.05pF	<b>GJM0222C1C7R8WB01#</b>
				±0.1pF	<b>GJM0222C1C7R8BB01#</b>
				±0.25pF	<b>GJM0222C1C7R8CB01#</b>
				±0.5pF	<b>GJM0222C1C7R8DB01#</b>
			7.9pF	±0.05pF	<b>GJM0222C1C7R9WB01#</b>
				±0.1pF	<b>GJM0222C1C7R9BB01#</b>
				±0.25pF	<b>GJM0222C1C7R9CB01#</b>
				±0.5pF	<b>GJM0222C1C7R9DB01#</b>

T max.	Rated Voltage	TC Code	Cap.	Tol.	Part Number
0.22mm	16Vdc	CH	8.0pF	±0.05pF	<b>GJM0222C1C8R0WB01#</b>
				±0.1pF	<b>GJM0222C1C8R0BB01#</b>
				±0.25pF	<b>GJM0222C1C8R0CB01#</b>
				±0.5pF	<b>GJM0222C1C8R0DB01#</b>
			8.1pF	±0.05pF	<b>GJM0222C1C8R1WB01#</b>
				±0.1pF	<b>GJM0222C1C8R1BB01#</b>
				±0.25pF	<b>GJM0222C1C8R1CB01#</b>
				±0.5pF	<b>GJM0222C1C8R1DB01#</b>
			8.2pF	±0.05pF	<b>GJM0222C1C8R2WB01#</b>
				±0.1pF	<b>GJM0222C1C8R2BB01#</b>
				±0.25pF	<b>GJM0222C1C8R2CB01#</b>
				±0.5pF	<b>GJM0222C1C8R2DB01#</b>
			8.3pF	±0.05pF	<b>GJM0222C1C8R3WB01#</b>
				±0.1pF	<b>GJM0222C1C8R3BB01#</b>
				±0.25pF	<b>GJM0222C1C8R3CB01#</b>
				±0.5pF	<b>GJM0222C1C8R3DB01#</b>
			8.4pF	±0.05pF	<b>GJM0222C1C8R4WB01#</b>
				±0.1pF	<b>GJM0222C1C8R4BB01#</b>
				±0.25pF	<b>GJM0222C1C8R4CB01#</b>
				±0.5pF	<b>GJM0222C1C8R4DB01#</b>
			8.5pF	±0.05pF	<b>GJM0222C1C8R5WB01#</b>
				±0.1pF	<b>GJM0222C1C8R5BB01#</b>
				±0.25pF	<b>GJM0222C1C8R5CB01#</b>
				±0.5pF	<b>GJM0222C1C8R5DB01#</b>
			8.6pF	±0.05pF	<b>GJM0222C1C8R6WB01#</b>
				±0.1pF	<b>GJM0222C1C8R6BB01#</b>
				±0.25pF	<b>GJM0222C1C8R6CB01#</b>
				±0.5pF	<b>GJM0222C1C8R6DB01#</b>
			8.7pF	±0.05pF	<b>GJM0222C1C8R7WB01#</b>
				±0.1pF	<b>GJM0222C1C8R7BB01#</b>
				±0.25pF	<b>GJM0222C1C8R7CB01#</b>
				±0.5pF	<b>GJM0222C1C8R7DB01#</b>
			8.8pF	±0.05pF	<b>GJM0222C1C8R8WB01#</b>
				±0.1pF	<b>GJM0222C1C8R8BB01#</b>
				±0.25pF	<b>GJM0222C1C8R8CB01#</b>
				±0.5pF	<b>GJM0222C1C8R8DB01#</b>
			8.9pF	±0.05pF	<b>GJM0222C1C8R9WB01#</b>
				±0.1pF	<b>GJM0222C1C8R9BB01#</b>
				±0.25pF	<b>GJM0222C1C8R9CB01#</b>
				±0.5pF	<b>GJM0222C1C8R9DB01#</b>
			9.0pF	±0.05pF	<b>GJM0222C1C9R0WB01#</b>
				±0.1pF	<b>GJM0222C1C9R0BB01#</b>
				±0.25pF	<b>GJM0222C1C9R0CB01#</b>
				±0.5pF	<b>GJM0222C1C9R0DB01#</b>
			9.1pF	±0.05pF	<b>GJM0222C1C9R1WB01#</b>
				±0.1pF	<b>GJM0222C1C9R1BB01#</b>
				±0.25pF	<b>GJM0222C1C9R1CB01#</b>
				±0.5pF	<b>GJM0222C1C9R1DB01#</b>
			9.2pF	±0.05pF	<b>GJM0222C1C9R2WB01#</b>
				±0.1pF	<b>GJM0222C1C9R2BB01#</b>
				±0.25pF	<b>GJM0222C1C9R2CB01#</b>
				±0.5pF	<b>GJM0222C1C9R2DB01#</b>
			9.3pF	±0.05pF	<b>GJM0222C1C9R3WB01#</b>
				±0.1pF	<b>GJM0222C1C9R3BB01#</b>

Part number # indicates the package specification code.

For General Purpose GRM Series  
 Capacitor Array GNM Series  
 Low ESL LLQ Series  
 High-Q Type GJM Series  
 High Frequency GQM Series  
 Monolithic Microchip GMA Series  
 For Bonding GMD Series  
 Product Information

# GJM Series Temperature Compensating Type HiQ Part Number List

(→ ■ 0.4x0.2mm)

T max.	Rated Voltage	TC Code	Cap.	Tol.	Part Number
0.22mm	16Vdc	CH	9.3pF	±0.25pF	<b>GJM0222C1C9R3CB01#</b>
				±0.5pF	<b>GJM0222C1C9R3DB01#</b>
			9.4pF	±0.05pF	<b>GJM0222C1C9R4WB01#</b>
				±0.1pF	<b>GJM0222C1C9R4BB01#</b>
				±0.25pF	<b>GJM0222C1C9R4CB01#</b>
				±0.5pF	<b>GJM0222C1C9R4DB01#</b>
			9.5pF	±0.05pF	<b>GJM0222C1C9R5WB01#</b>
				±0.1pF	<b>GJM0222C1C9R5BB01#</b>
				±0.25pF	<b>GJM0222C1C9R5CB01#</b>
				±0.5pF	<b>GJM0222C1C9R5DB01#</b>
			9.6pF	±0.05pF	<b>GJM0222C1C9R6WB01#</b>
				±0.1pF	<b>GJM0222C1C9R6BB01#</b>
				±0.25pF	<b>GJM0222C1C9R6CB01#</b>
				±0.5pF	<b>GJM0222C1C9R6DB01#</b>
			9.7pF	±0.05pF	<b>GJM0222C1C9R7WB01#</b>
				±0.1pF	<b>GJM0222C1C9R7BB01#</b>
				±0.25pF	<b>GJM0222C1C9R7CB01#</b>
				±0.5pF	<b>GJM0222C1C9R7DB01#</b>
			9.8pF	±0.05pF	<b>GJM0222C1C9R8WB01#</b>
				±0.1pF	<b>GJM0222C1C9R8BB01#</b>
				±0.25pF	<b>GJM0222C1C9R8CB01#</b>
				±0.5pF	<b>GJM0222C1C9R8DB01#</b>
			9.9pF	±0.05pF	<b>GJM0222C1C9R9WB01#</b>
				±0.1pF	<b>GJM0222C1C9R9BB01#</b>
				±0.25pF	<b>GJM0222C1C9R9CB01#</b>
				±0.5pF	<b>GJM0222C1C9R9DB01#</b>
			10pF	±2%	<b>GJM0222C1C100GB01#</b>
				±5%	<b>GJM0222C1C100JB01#</b>

T max.	Rated Voltage	TC Code	Cap.	Tol.	Part Number
0.33mm	25Vdc	C0G	1.1pF	±0.25pF	<b>GJM0335C1E1R1CB01#</b>
				±0.05pF	<b>GJM0335C1E1R2WB01#</b>
			1.2pF	±0.1pF	<b>GJM0335C1E1R2BB01#</b>
				±0.25pF	<b>GJM0335C1E1R2CB01#</b>
				±0.05pF	<b>GJM0335C1E1R3WB01#</b>
			1.3pF	±0.1pF	<b>GJM0335C1E1R3BB01#</b>
				±0.25pF	<b>GJM0335C1E1R3CB01#</b>
				±0.05pF	<b>GJM0335C1E1R4WB01#</b>
			1.4pF	±0.1pF	<b>GJM0335C1E1R4BB01#</b>
				±0.25pF	<b>GJM0335C1E1R4CB01#</b>
				±0.05pF	<b>GJM0335C1E1R5WB01#</b>
			1.5pF	±0.1pF	<b>GJM0335C1E1R5BB01#</b>
				±0.25pF	<b>GJM0335C1E1R5CB01#</b>
				±0.05pF	<b>GJM0335C1E1R6WB01#</b>
			1.6pF	±0.1pF	<b>GJM0335C1E1R6BB01#</b>
				±0.25pF	<b>GJM0335C1E1R6CB01#</b>
				±0.05pF	<b>GJM0335C1E1R7WB01#</b>
			1.7pF	±0.1pF	<b>GJM0335C1E1R7BB01#</b>
				±0.25pF	<b>GJM0335C1E1R7CB01#</b>
				±0.05pF	<b>GJM0335C1E1R8WB01#</b>
			1.8pF	±0.1pF	<b>GJM0335C1E1R8BB01#</b>
				±0.25pF	<b>GJM0335C1E1R8CB01#</b>
				±0.05pF	<b>GJM0335C1E1R9WB01#</b>
			1.9pF	±0.1pF	<b>GJM0335C1E1R9BB01#</b>
				±0.25pF	<b>GJM0335C1E1R9CB01#</b>
				±0.05pF	<b>GJM0335C1E2R0WB01#</b>
			2.0pF	±0.1pF	<b>GJM0335C1E2R0BB01#</b>
				±0.25pF	<b>GJM0335C1E2R0CB01#</b>
				±0.05pF	<b>GJM0335C1E2R1WB01#</b>
			2.1pF	±0.1pF	<b>GJM0335C1E2R1BB01#</b>
				±0.25pF	<b>GJM0335C1E2R1CB01#</b>
				±0.05pF	<b>GJM0335C1E2R2WB01#</b>
			2.2pF	±0.1pF	<b>GJM0335C1E2R2BB01#</b>
				±0.25pF	<b>GJM0335C1E2R2CB01#</b>
				±0.05pF	<b>GJM0335C1E2R3WB01#</b>
			2.3pF	±0.1pF	<b>GJM0335C1E2R3BB01#</b>
				±0.25pF	<b>GJM0335C1E2R3CB01#</b>
				±0.05pF	<b>GJM0335C1E2R4WB01#</b>
			2.4pF	±0.1pF	<b>GJM0335C1E2R4BB01#</b>
				±0.25pF	<b>GJM0335C1E2R4CB01#</b>
				±0.05pF	<b>GJM0335C1E2R5WB01#</b>
			2.5pF	±0.1pF	<b>GJM0335C1E2R5BB01#</b>
				±0.25pF	<b>GJM0335C1E2R5CB01#</b>
				±0.05pF	<b>GJM0335C1E2R6WB01#</b>
			2.6pF	±0.1pF	<b>GJM0335C1E2R6BB01#</b>
				±0.25pF	<b>GJM0335C1E2R6CB01#</b>
				±0.05pF	<b>GJM0335C1E2R7WB01#</b>
			2.7pF	±0.1pF	<b>GJM0335C1E2R7BB01#</b>
				±0.25pF	<b>GJM0335C1E2R7CB01#</b>
				±0.05pF	<b>GJM0335C1E2R8WB01#</b>
			2.8pF	±0.1pF	<b>GJM0335C1E2R8BB01#</b>
				±0.25pF	<b>GJM0335C1E2R8CB01#</b>
				±0.05pF	<b>GJM0335C1E2R9WB01#</b>
			2.9pF	±0.1pF	<b>GJM0335C1E2R9BB01#</b>

■ 0.6x0.3mm Ultra-compact

T max.	Rated Voltage	TC Code	Cap.	Tol.	Part Number
0.33mm	25Vdc	C0G	0.2pF	±0.05pF	<b>GJM0335C1ER20WB01#</b>
				±0.1pF	<b>GJM0335C1ER20BB01#</b>
			0.3pF	±0.05pF	<b>GJM0335C1ER30WB01#</b>
				±0.1pF	<b>GJM0335C1ER30BB01#</b>
			0.4pF	±0.05pF	<b>GJM0335C1ER40WB01#</b>
				±0.1pF	<b>GJM0335C1ER40BB01#</b>
			0.5pF	±0.05pF	<b>GJM0335C1ER50WB01#</b>
				±0.1pF	<b>GJM0335C1ER50BB01#</b>
			0.6pF	±0.05pF	<b>GJM0335C1ER60WB01#</b>
				±0.1pF	<b>GJM0335C1ER60BB01#</b>
			0.7pF	±0.05pF	<b>GJM0335C1ER70WB01#</b>
				±0.1pF	<b>GJM0335C1ER70BB01#</b>
			0.8pF	±0.05pF	<b>GJM0335C1ER80WB01#</b>
				±0.1pF	<b>GJM0335C1ER80BB01#</b>
			0.9pF	±0.05pF	<b>GJM0335C1ER90WB01#</b>
				±0.1pF	<b>GJM0335C1ER90BB01#</b>
			1.0pF	±0.05pF	<b>GJM0335C1E1R0WB01#</b>
				±0.1pF	<b>GJM0335C1E1R0BB01#</b>
				±0.25pF	<b>GJM0335C1E1R0CB01#</b>
			1.1pF	±0.05pF	<b>GJM0335C1E1R1WB01#</b>
				±0.1pF	<b>GJM0335C1E1R1BB01#</b>

For General Purpose GRM Series  
 Capacitor Array GNM Series  
 Low ESL LLL Series  
 High-Q Type GJM Series  
 High Frequency GQM Series  
 Monolithic Microchip GMA Series  
 For Bonding GMD Series  
 Product Information

Part number # indicates the package specification code.



## GJM Series Temperature Compensating Type HiQ Part Number List

(→ ■ 0.6x0.3mm)

T max.	Rated Voltage	TC Code	Cap.	Tol.	Part Number
0.33mm	25Vdc	C0G	2.9pF	±0.25pF	<b>GJM0335C1E2R9CB01#</b>
				±0.05pF	<b>GJM0335C1E3R0WB01#</b>
					±0.1pF
			±0.25pF		<b>GJM0335C1E3R0CB01#</b>
			3.1pF	±0.05pF	<b>GJM0335C1E3R1WB01#</b>
				±0.1pF	<b>GJM0335C1E3R1BB01#</b>
				±0.25pF	<b>GJM0335C1E3R1CB01#</b>
			3.2pF	±0.05pF	<b>GJM0335C1E3R2WB01#</b>
				±0.1pF	<b>GJM0335C1E3R2BB01#</b>
				±0.25pF	<b>GJM0335C1E3R2CB01#</b>
			3.3pF	±0.05pF	<b>GJM0335C1E3R3WB01#</b>
				±0.1pF	<b>GJM0335C1E3R3BB01#</b>
				±0.25pF	<b>GJM0335C1E3R3CB01#</b>
			3.4pF	±0.05pF	<b>GJM0335C1E3R4WB01#</b>
				±0.1pF	<b>GJM0335C1E3R4BB01#</b>
				±0.25pF	<b>GJM0335C1E3R4CB01#</b>
			3.5pF	±0.05pF	<b>GJM0335C1E3R5WB01#</b>
				±0.1pF	<b>GJM0335C1E3R5BB01#</b>
				±0.25pF	<b>GJM0335C1E3R5CB01#</b>
			3.6pF	±0.05pF	<b>GJM0335C1E3R6WB01#</b>
				±0.1pF	<b>GJM0335C1E3R6BB01#</b>
				±0.25pF	<b>GJM0335C1E3R6CB01#</b>
			3.7pF	±0.05pF	<b>GJM0335C1E3R7WB01#</b>
				±0.1pF	<b>GJM0335C1E3R7BB01#</b>
				±0.25pF	<b>GJM0335C1E3R7CB01#</b>
			3.8pF	±0.05pF	<b>GJM0335C1E3R8WB01#</b>
				±0.1pF	<b>GJM0335C1E3R8BB01#</b>
				±0.25pF	<b>GJM0335C1E3R8CB01#</b>
			3.9pF	±0.05pF	<b>GJM0335C1E3R9WB01#</b>
				±0.1pF	<b>GJM0335C1E3R9BB01#</b>
				±0.25pF	<b>GJM0335C1E3R9CB01#</b>
			4.0pF	±0.05pF	<b>GJM0335C1E4R0WB01#</b>
				±0.1pF	<b>GJM0335C1E4R0BB01#</b>
				±0.25pF	<b>GJM0335C1E4R0CB01#</b>
			4.1pF	±0.05pF	<b>GJM0335C1E4R1WB01#</b>
				±0.1pF	<b>GJM0335C1E4R1BB01#</b>
				±0.25pF	<b>GJM0335C1E4R1CB01#</b>
			4.2pF	±0.05pF	<b>GJM0335C1E4R2WB01#</b>
				±0.1pF	<b>GJM0335C1E4R2BB01#</b>
				±0.25pF	<b>GJM0335C1E4R2CB01#</b>
			4.3pF	±0.05pF	<b>GJM0335C1E4R3WB01#</b>
				±0.1pF	<b>GJM0335C1E4R3BB01#</b>
				±0.25pF	<b>GJM0335C1E4R3CB01#</b>
			4.4pF	±0.05pF	<b>GJM0335C1E4R4WB01#</b>
				±0.1pF	<b>GJM0335C1E4R4BB01#</b>
				±0.25pF	<b>GJM0335C1E4R4CB01#</b>
			4.5pF	±0.05pF	<b>GJM0335C1E4R5WB01#</b>
				±0.1pF	<b>GJM0335C1E4R5BB01#</b>
				±0.25pF	<b>GJM0335C1E4R5CB01#</b>
			4.6pF	±0.05pF	<b>GJM0335C1E4R6WB01#</b>
				±0.1pF	<b>GJM0335C1E4R6BB01#</b>
				±0.25pF	<b>GJM0335C1E4R6CB01#</b>
			4.7pF	±0.05pF	<b>GJM0335C1E4R7WB01#</b>
				±0.1pF	<b>GJM0335C1E4R7BB01#</b>

T max.	Rated Voltage	TC Code	Cap.	Tol.	Part Number
0.33mm	25Vdc	C0G	4.7pF	±0.25pF	<b>GJM0335C1E4R7CB01#</b>
				±0.05pF	<b>GJM0335C1E4R8WB01#</b>
					±0.1pF
			±0.25pF		<b>GJM0335C1E4R8CB01#</b>
			4.9pF	±0.05pF	<b>GJM0335C1E4R9WB01#</b>
				±0.1pF	<b>GJM0335C1E4R9BB01#</b>
				±0.25pF	<b>GJM0335C1E4R9CB01#</b>
			5.0pF	±0.05pF	<b>GJM0335C1E5R0WB01#</b>
				±0.1pF	<b>GJM0335C1E5R0BB01#</b>
				±0.25pF	<b>GJM0335C1E5R0CB01#</b>
			5.1pF	±0.05pF	<b>GJM0335C1E5R1WB01#</b>
				±0.1pF	<b>GJM0335C1E5R1BB01#</b>
				±0.25pF	<b>GJM0335C1E5R1CB01#</b>
			5.2pF	±0.05pF	<b>GJM0335C1E5R2WB01#</b>
				±0.1pF	<b>GJM0335C1E5R2BB01#</b>
				±0.25pF	<b>GJM0335C1E5R2CB01#</b>
			5.3pF	±0.05pF	<b>GJM0335C1E5R3WB01#</b>
				±0.1pF	<b>GJM0335C1E5R3BB01#</b>
				±0.25pF	<b>GJM0335C1E5R3CB01#</b>
			5.4pF	±0.05pF	<b>GJM0335C1E5R4WB01#</b>
				±0.1pF	<b>GJM0335C1E5R4BB01#</b>
				±0.25pF	<b>GJM0335C1E5R4CB01#</b>
			5.5pF	±0.05pF	<b>GJM0335C1E5R5WB01#</b>
				±0.1pF	<b>GJM0335C1E5R5BB01#</b>
				±0.25pF	<b>GJM0335C1E5R5CB01#</b>
			5.6pF	±0.05pF	<b>GJM0335C1E5R6WB01#</b>
				±0.1pF	<b>GJM0335C1E5R6BB01#</b>
				±0.25pF	<b>GJM0335C1E5R6CB01#</b>
			5.7pF	±0.05pF	<b>GJM0335C1E5R7WB01#</b>
				±0.1pF	<b>GJM0335C1E5R7BB01#</b>
				±0.25pF	<b>GJM0335C1E5R7CB01#</b>
			5.8pF	±0.05pF	<b>GJM0335C1E5R8WB01#</b>
				±0.1pF	<b>GJM0335C1E5R8BB01#</b>
				±0.25pF	<b>GJM0335C1E5R8CB01#</b>
			5.9pF	±0.05pF	<b>GJM0335C1E5R9WB01#</b>
				±0.1pF	<b>GJM0335C1E5R9BB01#</b>
				±0.25pF	<b>GJM0335C1E5R9CB01#</b>
			6.0pF	±0.05pF	<b>GJM0335C1E6R0WB01#</b>
				±0.1pF	<b>GJM0335C1E6R0BB01#</b>
				±0.25pF	<b>GJM0335C1E6R0CB01#</b>
			6.1pF	±0.05pF	<b>GJM0335C1E6R1WB01#</b>
				±0.1pF	<b>GJM0335C1E6R1BB01#</b>
				±0.25pF	<b>GJM0335C1E6R1CB01#</b>

Part number # indicates the package specification code.

# GJM Series Temperature Compensating Type HiQ Part Number List

(→ ■ 0.6x0.3mm)

T max.	Rated Voltage	TC Code	Cap.	Tol.	Part Number
0.33mm	25Vdc	C0G	6.2pF	±0.05pF	<b>GJM0335C1E6R2WB01#</b>
				±0.1pF	<b>GJM0335C1E6R2BB01#</b>
				±0.25pF	<b>GJM0335C1E6R2CB01#</b>
				±0.5pF	<b>GJM0335C1E6R2DB01#</b>
			6.3pF	±0.05pF	<b>GJM0335C1E6R3WB01#</b>
				±0.1pF	<b>GJM0335C1E6R3BB01#</b>
				±0.25pF	<b>GJM0335C1E6R3CB01#</b>
				±0.5pF	<b>GJM0335C1E6R3DB01#</b>
			6.4pF	±0.05pF	<b>GJM0335C1E6R4WB01#</b>
				±0.1pF	<b>GJM0335C1E6R4BB01#</b>
				±0.25pF	<b>GJM0335C1E6R4CB01#</b>
				±0.5pF	<b>GJM0335C1E6R4DB01#</b>
			6.5pF	±0.05pF	<b>GJM0335C1E6R5WB01#</b>
				±0.1pF	<b>GJM0335C1E6R5BB01#</b>
				±0.25pF	<b>GJM0335C1E6R5CB01#</b>
				±0.5pF	<b>GJM0335C1E6R5DB01#</b>
			6.6pF	±0.05pF	<b>GJM0335C1E6R6WB01#</b>
				±0.1pF	<b>GJM0335C1E6R6BB01#</b>
				±0.25pF	<b>GJM0335C1E6R6CB01#</b>
				±0.5pF	<b>GJM0335C1E6R6DB01#</b>
			6.7pF	±0.05pF	<b>GJM0335C1E6R7WB01#</b>
				±0.1pF	<b>GJM0335C1E6R7BB01#</b>
				±0.25pF	<b>GJM0335C1E6R7CB01#</b>
				±0.5pF	<b>GJM0335C1E6R7DB01#</b>
		6.8pF	±0.05pF	<b>GJM0335C1E6R8WB01#</b>	
			±0.1pF	<b>GJM0335C1E6R8BB01#</b>	
			±0.25pF	<b>GJM0335C1E6R8CB01#</b>	
			±0.5pF	<b>GJM0335C1E6R8DB01#</b>	
		C0H	6.9pF	±0.05pF	<b>GJM0336C1E6R9WB01#</b>
				±0.1pF	<b>GJM0336C1E6R9BB01#</b>
				±0.25pF	<b>GJM0336C1E6R9CB01#</b>
				±0.5pF	<b>GJM0336C1E6R9DB01#</b>
			7.0pF	±0.05pF	<b>GJM0336C1E7R0WB01#</b>
				±0.1pF	<b>GJM0336C1E7R0BB01#</b>
				±0.25pF	<b>GJM0336C1E7R0CB01#</b>
				±0.5pF	<b>GJM0336C1E7R0DB01#</b>
			7.1pF	±0.05pF	<b>GJM0336C1E7R1WB01#</b>
				±0.1pF	<b>GJM0336C1E7R1BB01#</b>
				±0.25pF	<b>GJM0336C1E7R1CB01#</b>
				±0.5pF	<b>GJM0336C1E7R1DB01#</b>
			7.2pF	±0.05pF	<b>GJM0336C1E7R2WB01#</b>
				±0.1pF	<b>GJM0336C1E7R2BB01#</b>
				±0.25pF	<b>GJM0336C1E7R2CB01#</b>
				±0.5pF	<b>GJM0336C1E7R2DB01#</b>
			7.3pF	±0.05pF	<b>GJM0336C1E7R3WB01#</b>
				±0.1pF	<b>GJM0336C1E7R3BB01#</b>
				±0.25pF	<b>GJM0336C1E7R3CB01#</b>
				±0.5pF	<b>GJM0336C1E7R3DB01#</b>
7.4pF	±0.05pF		<b>GJM0336C1E7R4WB01#</b>		
	±0.1pF		<b>GJM0336C1E7R4BB01#</b>		
	±0.25pF		<b>GJM0336C1E7R4CB01#</b>		
	±0.5pF		<b>GJM0336C1E7R4DB01#</b>		
7.5pF	±0.05pF	<b>GJM0336C1E7R5WB01#</b>			
	±0.1pF	<b>GJM0336C1E7R5BB01#</b>			

T max.	Rated Voltage	TC Code	Cap.	Tol.	Part Number
0.33mm	25Vdc	C0H	7.5pF	±0.25pF	<b>GJM0336C1E7R5CB01#</b>
				±0.5pF	<b>GJM0336C1E7R5DB01#</b>
			7.6pF	±0.05pF	<b>GJM0336C1E7R6WB01#</b>
				±0.1pF	<b>GJM0336C1E7R6BB01#</b>
				±0.25pF	<b>GJM0336C1E7R6CB01#</b>
			7.7pF	±0.05pF	<b>GJM0336C1E7R7WB01#</b>
				±0.1pF	<b>GJM0336C1E7R7BB01#</b>
				±0.25pF	<b>GJM0336C1E7R7CB01#</b>
			7.8pF	±0.05pF	<b>GJM0336C1E7R8WB01#</b>
				±0.1pF	<b>GJM0336C1E7R8BB01#</b>
				±0.25pF	<b>GJM0336C1E7R8CB01#</b>
			7.9pF	±0.05pF	<b>GJM0336C1E7R9WB01#</b>
				±0.1pF	<b>GJM0336C1E7R9BB01#</b>
				±0.25pF	<b>GJM0336C1E7R9CB01#</b>
			8.0pF	±0.05pF	<b>GJM0336C1E8R0WB01#</b>
				±0.1pF	<b>GJM0336C1E8R0BB01#</b>
				±0.25pF	<b>GJM0336C1E8R0CB01#</b>
			8.1pF	±0.05pF	<b>GJM0336C1E8R1WB01#</b>
				±0.1pF	<b>GJM0336C1E8R1BB01#</b>
				±0.25pF	<b>GJM0336C1E8R1CB01#</b>
			8.2pF	±0.05pF	<b>GJM0336C1E8R2WB01#</b>
				±0.1pF	<b>GJM0336C1E8R2BB01#</b>
				±0.25pF	<b>GJM0336C1E8R2CB01#</b>
			8.3pF	±0.05pF	<b>GJM0336C1E8R3WB01#</b>
				±0.1pF	<b>GJM0336C1E8R3BB01#</b>
				±0.25pF	<b>GJM0336C1E8R3CB01#</b>
			8.4pF	±0.05pF	<b>GJM0336C1E8R4WB01#</b>
				±0.1pF	<b>GJM0336C1E8R4BB01#</b>
				±0.25pF	<b>GJM0336C1E8R4CB01#</b>
			8.5pF	±0.05pF	<b>GJM0336C1E8R5WB01#</b>
				±0.1pF	<b>GJM0336C1E8R5BB01#</b>
				±0.25pF	<b>GJM0336C1E8R5CB01#</b>
			8.6pF	±0.05pF	<b>GJM0336C1E8R6WB01#</b>
				±0.1pF	<b>GJM0336C1E8R6BB01#</b>
				±0.25pF	<b>GJM0336C1E8R6CB01#</b>
			8.7pF	±0.05pF	<b>GJM0336C1E8R7WB01#</b>
				±0.1pF	<b>GJM0336C1E8R7BB01#</b>
				±0.25pF	<b>GJM0336C1E8R7CB01#</b>
			8.8pF	±0.05pF	<b>GJM0336C1E8R8WB01#</b>
				±0.1pF	<b>GJM0336C1E8R8BB01#</b>
				±0.25pF	<b>GJM0336C1E8R8CB01#</b>

Part number # indicates the package specification code.

For General Purpose GRM Series  
 Capacitor Array GNM Series  
 Low ESL LL□ Series  
 High-Q Type GJM Series  
 High Frequency GQM Series  
 Monolithic Microchip GMA Series  
 For Bonding GMD Series  
 Product Information

## GJM Series Temperature Compensating Type HiQ Part Number List

(→ ■ 0.6x0.3mm)

T max.	Rated Voltage	TC Code	Cap.	Tol.	Part Number
0.33mm	25Vdc	C0H	8.9pF	±0.05pF	<b>GJM0336C1E8R9WB01#</b>
				±0.1pF	<b>GJM0336C1E8R9BB01#</b>
				±0.25pF	<b>GJM0336C1E8R9CB01#</b>
				±0.5pF	<b>GJM0336C1E8R9DB01#</b>
			9.0pF	±0.05pF	<b>GJM0336C1E9R0WB01#</b>
				±0.1pF	<b>GJM0336C1E9R0BB01#</b>
				±0.25pF	<b>GJM0336C1E9R0CB01#</b>
				±0.5pF	<b>GJM0336C1E9R0DB01#</b>
			9.1pF	±0.05pF	<b>GJM0336C1E9R1WB01#</b>
				±0.1pF	<b>GJM0336C1E9R1BB01#</b>
				±0.25pF	<b>GJM0336C1E9R1CB01#</b>
				±0.5pF	<b>GJM0336C1E9R1DB01#</b>
			9.2pF	±0.05pF	<b>GJM0336C1E9R2WB01#</b>
				±0.1pF	<b>GJM0336C1E9R2BB01#</b>
				±0.25pF	<b>GJM0336C1E9R2CB01#</b>
				±0.5pF	<b>GJM0336C1E9R2DB01#</b>
			9.3pF	±0.05pF	<b>GJM0336C1E9R3WB01#</b>
				±0.1pF	<b>GJM0336C1E9R3BB01#</b>
				±0.25pF	<b>GJM0336C1E9R3CB01#</b>
				±0.5pF	<b>GJM0336C1E9R3DB01#</b>
			9.4pF	±0.05pF	<b>GJM0336C1E9R4WB01#</b>
				±0.1pF	<b>GJM0336C1E9R4BB01#</b>
				±0.25pF	<b>GJM0336C1E9R4CB01#</b>
				±0.5pF	<b>GJM0336C1E9R4DB01#</b>
			9.5pF	±0.05pF	<b>GJM0336C1E9R5WB01#</b>
				±0.1pF	<b>GJM0336C1E9R5BB01#</b>
				±0.25pF	<b>GJM0336C1E9R5CB01#</b>
				±0.5pF	<b>GJM0336C1E9R5DB01#</b>
			9.6pF	±0.05pF	<b>GJM0336C1E9R6WB01#</b>
				±0.1pF	<b>GJM0336C1E9R6BB01#</b>
				±0.25pF	<b>GJM0336C1E9R6CB01#</b>
				±0.5pF	<b>GJM0336C1E9R6DB01#</b>
			9.7pF	±0.05pF	<b>GJM0336C1E9R7WB01#</b>
				±0.1pF	<b>GJM0336C1E9R7BB01#</b>
				±0.25pF	<b>GJM0336C1E9R7CB01#</b>
				±0.5pF	<b>GJM0336C1E9R7DB01#</b>
			9.8pF	±0.05pF	<b>GJM0336C1E9R8WB01#</b>
				±0.1pF	<b>GJM0336C1E9R8BB01#</b>
				±0.25pF	<b>GJM0336C1E9R8CB01#</b>
				±0.5pF	<b>GJM0336C1E9R8DB01#</b>
			9.9pF	±0.05pF	<b>GJM0336C1E9R9WB01#</b>
				±0.1pF	<b>GJM0336C1E9R9BB01#</b>
				±0.25pF	<b>GJM0336C1E9R9CB01#</b>
				±0.5pF	<b>GJM0336C1E9R9DB01#</b>
			10pF	±2%	<b>GJM0336C1E100GB01#</b>
				±5%	<b>GJM0336C1E100JB01#</b>
			11pF	±2%	<b>GJM0336C1E110GB01#</b>
				±5%	<b>GJM0336C1E110JB01#</b>
			12pF	±2%	<b>GJM0336C1E120GB01#</b>
				±5%	<b>GJM0336C1E120JB01#</b>
			13pF	±2%	<b>GJM0336C1E130GB01#</b>
				±5%	<b>GJM0336C1E130JB01#</b>
			15pF	±2%	<b>GJM0336C1E150GB01#</b>
				±5%	<b>GJM0336C1E150JB01#</b>

T max.	Rated Voltage	TC Code	Cap.	Tol.	Part Number	
0.33mm	25Vdc	C0H	16pF	±2%	<b>GJM0336C1E160GB01#</b>	
				±5%	<b>GJM0336C1E160JB01#</b>	
			18pF	±2%	<b>GJM0336C1E180GB01#</b>	
				±5%	<b>GJM0336C1E180JB01#</b>	
			20pF	±2%	<b>GJM0336C1E200GB01#</b>	
				±5%	<b>GJM0336C1E200JB01#</b>	
			CK	0.2pF	±0.05pF	<b>GJM0334C1ER20WB01#</b>
					±0.1pF	<b>GJM0334C1ER20BB01#</b>
				0.3pF	±0.05pF	<b>GJM0334C1ER30WB01#</b>
					±0.1pF	<b>GJM0334C1ER30BB01#</b>
				0.4pF	±0.05pF	<b>GJM0334C1ER40WB01#</b>
					±0.1pF	<b>GJM0334C1ER40BB01#</b>
				0.5pF	±0.05pF	<b>GJM0334C1ER50WB01#</b>
					±0.1pF	<b>GJM0334C1ER50BB01#</b>
				0.6pF	±0.05pF	<b>GJM0334C1ER60WB01#</b>
					±0.1pF	<b>GJM0334C1ER60BB01#</b>
				0.7pF	±0.05pF	<b>GJM0334C1ER70WB01#</b>
					±0.1pF	<b>GJM0334C1ER70BB01#</b>
				0.8pF	±0.05pF	<b>GJM0334C1ER80WB01#</b>
					±0.1pF	<b>GJM0334C1ER80BB01#</b>
				0.9pF	±0.05pF	<b>GJM0334C1ER90WB01#</b>
		±0.1pF			<b>GJM0334C1ER90BB01#</b>	
		1.0pF		±0.05pF	<b>GJM0334C1E1R0WB01#</b>	
				±0.1pF	<b>GJM0334C1E1R0BB01#</b>	
				±0.25pF	<b>GJM0334C1E1R0CB01#</b>	
		1.1pF		±0.05pF	<b>GJM0334C1E1R1WB01#</b>	
				±0.1pF	<b>GJM0334C1E1R1BB01#</b>	
			±0.25pF	<b>GJM0334C1E1R1CB01#</b>		
		1.2pF	±0.05pF	<b>GJM0334C1E1R2WB01#</b>		
			±0.1pF	<b>GJM0334C1E1R2BB01#</b>		
			±0.25pF	<b>GJM0334C1E1R2CB01#</b>		
		1.3pF	±0.05pF	<b>GJM0334C1E1R3WB01#</b>		
			±0.1pF	<b>GJM0334C1E1R3BB01#</b>		
			±0.25pF	<b>GJM0334C1E1R3CB01#</b>		
		1.4pF	±0.05pF	<b>GJM0334C1E1R4WB01#</b>		
			±0.1pF	<b>GJM0334C1E1R4BB01#</b>		
			±0.25pF	<b>GJM0334C1E1R4CB01#</b>		
		1.5pF	±0.05pF	<b>GJM0334C1E1R5WB01#</b>		
			±0.1pF	<b>GJM0334C1E1R5BB01#</b>		
			±0.25pF	<b>GJM0334C1E1R5CB01#</b>		
		1.6pF	±0.05pF	<b>GJM0334C1E1R6WB01#</b>		
			±0.1pF	<b>GJM0334C1E1R6BB01#</b>		
±0.25pF	<b>GJM0334C1E1R6CB01#</b>					
1.7pF	±0.05pF	<b>GJM0334C1E1R7WB01#</b>				
	±0.1pF	<b>GJM0334C1E1R7BB01#</b>				
	±0.25pF	<b>GJM0334C1E1R7CB01#</b>				
1.8pF	±0.05pF	<b>GJM0334C1E1R8WB01#</b>				
	±0.1pF	<b>GJM0334C1E1R8BB01#</b>				
	±0.25pF	<b>GJM0334C1E1R8CB01#</b>				
1.9pF	±0.05pF	<b>GJM0334C1E1R9WB01#</b>				
	±0.1pF	<b>GJM0334C1E1R9BB01#</b>				
	±0.25pF	<b>GJM0334C1E1R9CB01#</b>				
2.0pF	±0.05pF	<b>GJM0334C1E2R0WB01#</b>				
	±0.1pF	<b>GJM0334C1E2R0BB01#</b>				

Part number # indicates the package specification code.

For General Purpose GRM Series  
 Capacitor Array GNM Series  
 Low ESL LLD Series  
 High-Q Type GMI Series  
 High Frequency GQM Series  
 Monolithic Microchip GMA Series  
 For Bonding GMD Series  
 Product Information

## GJM Series Temperature Compensating Type HiQ Part Number List

(→ ■ 0.6x0.3mm)

T max.	Rated Voltage	TC Code	Cap.	Tol.	Part Number
0.33mm	25Vdc	CK	2.0pF	±0.25pF	<b>GJM0334C1E2R0CB01#</b>
			CJ	2.1pF	±0.05pF
		±0.1pF			<b>GJM0333C1E2R1BB01#</b>
		±0.25pF			<b>GJM0333C1E2R1CB01#</b>
		2.2pF		±0.05pF	<b>GJM0333C1E2R2WB01#</b>
				±0.1pF	<b>GJM0333C1E2R2BB01#</b>
				±0.25pF	<b>GJM0333C1E2R2CB01#</b>
		2.3pF		±0.05pF	<b>GJM0333C1E2R3WB01#</b>
				±0.1pF	<b>GJM0333C1E2R3BB01#</b>
				±0.25pF	<b>GJM0333C1E2R3CB01#</b>
		2.4pF		±0.05pF	<b>GJM0333C1E2R4WB01#</b>
				±0.1pF	<b>GJM0333C1E2R4BB01#</b>
				±0.25pF	<b>GJM0333C1E2R4CB01#</b>
		2.5pF		±0.05pF	<b>GJM0333C1E2R5WB01#</b>
				±0.1pF	<b>GJM0333C1E2R5BB01#</b>
				±0.25pF	<b>GJM0333C1E2R5CB01#</b>
		2.6pF		±0.05pF	<b>GJM0333C1E2R6WB01#</b>
				±0.1pF	<b>GJM0333C1E2R6BB01#</b>
				±0.25pF	<b>GJM0333C1E2R6CB01#</b>
		2.7pF	±0.05pF	<b>GJM0333C1E2R7WB01#</b>	
			±0.1pF	<b>GJM0333C1E2R7BB01#</b>	
			±0.25pF	<b>GJM0333C1E2R7CB01#</b>	
		2.8pF	±0.05pF	<b>GJM0333C1E2R8WB01#</b>	
			±0.1pF	<b>GJM0333C1E2R8BB01#</b>	
			±0.25pF	<b>GJM0333C1E2R8CB01#</b>	
		2.9pF	±0.05pF	<b>GJM0333C1E2R9WB01#</b>	
			±0.1pF	<b>GJM0333C1E2R9BB01#</b>	
			±0.25pF	<b>GJM0333C1E2R9CB01#</b>	
		3.0pF	±0.05pF	<b>GJM0333C1E3R0WB01#</b>	
			±0.1pF	<b>GJM0333C1E3R0BB01#</b>	
			±0.25pF	<b>GJM0333C1E3R0CB01#</b>	
		3.1pF	±0.05pF	<b>GJM0333C1E3R1WB01#</b>	
			±0.1pF	<b>GJM0333C1E3R1BB01#</b>	
			±0.25pF	<b>GJM0333C1E3R1CB01#</b>	
		3.2pF	±0.05pF	<b>GJM0333C1E3R2WB01#</b>	
			±0.1pF	<b>GJM0333C1E3R2BB01#</b>	
			±0.25pF	<b>GJM0333C1E3R2CB01#</b>	
		3.3pF	±0.05pF	<b>GJM0333C1E3R3WB01#</b>	
			±0.1pF	<b>GJM0333C1E3R3BB01#</b>	
			±0.25pF	<b>GJM0333C1E3R3CB01#</b>	
		3.4pF	±0.05pF	<b>GJM0333C1E3R4WB01#</b>	
			±0.1pF	<b>GJM0333C1E3R4BB01#</b>	
			±0.25pF	<b>GJM0333C1E3R4CB01#</b>	
		3.5pF	±0.05pF	<b>GJM0333C1E3R5WB01#</b>	
			±0.1pF	<b>GJM0333C1E3R5BB01#</b>	
			±0.25pF	<b>GJM0333C1E3R5CB01#</b>	
		3.6pF	±0.05pF	<b>GJM0333C1E3R6WB01#</b>	
			±0.1pF	<b>GJM0333C1E3R6BB01#</b>	
			±0.25pF	<b>GJM0333C1E3R6CB01#</b>	
		3.7pF	±0.05pF	<b>GJM0333C1E3R7WB01#</b>	
			±0.1pF	<b>GJM0333C1E3R7BB01#</b>	
			±0.25pF	<b>GJM0333C1E3R7CB01#</b>	
		3.8pF	±0.05pF	<b>GJM0333C1E3R8WB01#</b>	
			±0.1pF	<b>GJM0333C1E3R8BB01#</b>	

T max.	Rated Voltage	TC Code	Cap.	Tol.	Part Number
0.33mm	25Vdc	CJ	3.8pF	±0.25pF	<b>GJM0333C1E3R8CB01#</b>
			3.9pF	±0.05pF	<b>GJM0333C1E3R9WB01#</b>
				±0.1pF	<b>GJM0333C1E3R9BB01#</b>
				±0.25pF	<b>GJM0333C1E3R9CB01#</b>
			4.0pF	±0.05pF	<b>GJM0332C1E4R0WB01#</b>
				±0.1pF	<b>GJM0332C1E4R0BB01#</b>
				±0.25pF	<b>GJM0332C1E4R0CB01#</b>
			4.1pF	±0.05pF	<b>GJM0332C1E4R1WB01#</b>
				±0.1pF	<b>GJM0332C1E4R1BB01#</b>
				±0.25pF	<b>GJM0332C1E4R1CB01#</b>
			4.2pF	±0.05pF	<b>GJM0332C1E4R2WB01#</b>
				±0.1pF	<b>GJM0332C1E4R2BB01#</b>
				±0.25pF	<b>GJM0332C1E4R2CB01#</b>
			4.3pF	±0.05pF	<b>GJM0332C1E4R3WB01#</b>
				±0.1pF	<b>GJM0332C1E4R3BB01#</b>
				±0.25pF	<b>GJM0332C1E4R3CB01#</b>
			4.4pF	±0.05pF	<b>GJM0332C1E4R4WB01#</b>
				±0.1pF	<b>GJM0332C1E4R4BB01#</b>
		±0.25pF		<b>GJM0332C1E4R4CB01#</b>	
		4.5pF	±0.05pF	<b>GJM0332C1E4R5WB01#</b>	
			±0.1pF	<b>GJM0332C1E4R5BB01#</b>	
			±0.25pF	<b>GJM0332C1E4R5CB01#</b>	
		4.6pF	±0.05pF	<b>GJM0332C1E4R6WB01#</b>	
			±0.1pF	<b>GJM0332C1E4R6BB01#</b>	
			±0.25pF	<b>GJM0332C1E4R6CB01#</b>	
		4.7pF	±0.05pF	<b>GJM0332C1E4R7WB01#</b>	
			±0.1pF	<b>GJM0332C1E4R7BB01#</b>	
			±0.25pF	<b>GJM0332C1E4R7CB01#</b>	
		4.8pF	±0.05pF	<b>GJM0332C1E4R8WB01#</b>	
			±0.1pF	<b>GJM0332C1E4R8BB01#</b>	
			±0.25pF	<b>GJM0332C1E4R8CB01#</b>	
		4.9pF	±0.05pF	<b>GJM0332C1E4R9WB01#</b>	
			±0.1pF	<b>GJM0332C1E4R9BB01#</b>	
			±0.25pF	<b>GJM0332C1E4R9CB01#</b>	
		5.0pF	±0.05pF	<b>GJM0332C1E5R0WB01#</b>	
			±0.1pF	<b>GJM0332C1E5R0BB01#</b>	
			±0.25pF	<b>GJM0332C1E5R0CB01#</b>	
		5.1pF	±0.05pF	<b>GJM0332C1E5R1WB01#</b>	
			±0.1pF	<b>GJM0332C1E5R1BB01#</b>	
			±0.25pF	<b>GJM0332C1E5R1CB01#</b>	
		5.2pF	±0.05pF	<b>GJM0332C1E5R2WB01#</b>	
			±0.1pF	<b>GJM0332C1E5R2BB01#</b>	
			±0.25pF	<b>GJM0332C1E5R2CB01#</b>	
		5.3pF	±0.05pF	<b>GJM0332C1E5R3WB01#</b>	
			±0.1pF	<b>GJM0332C1E5R3BB01#</b>	
			±0.25pF	<b>GJM0332C1E5R3CB01#</b>	
		5.4pF	±0.05pF	<b>GJM0332C1E5R4WB01#</b>	
			±0.1pF	<b>GJM0332C1E5R4BB01#</b>	
			±0.25pF	<b>GJM0332C1E5R4CB01#</b>	
		5.5pF	±0.05pF	<b>GJM0332C1E5R5WB01#</b>	
			±0.1pF	<b>GJM0332C1E5R5BB01#</b>	

Part number # indicates the package specification code.

For General Purpose GRM Series  
 Capacitor Array GNM Series  
 Low ESL LL Series  
 High-Q Type GJM Series  
 High Frequency GQM Series  
 Monolithic Microchip GMA Series  
 For Bonding GMD Series  
 Product Information



## GJM Series Temperature Compensating Type HiQ Part Number List

(→ ■ 0.6x0.3mm)

T max.	Rated Voltage	TC Code	Cap.	Tol.	Part Number
0.33mm	25Vdc	CH	5.5pF	±0.1pF	<b>GJM0332C1E5R5BB01#</b>
				±0.25pF	<b>GJM0332C1E5R5CB01#</b>
				±0.5pF	<b>GJM0332C1E5R5DB01#</b>
			5.6pF	±0.05pF	<b>GJM0332C1E5R6WB01#</b>
				±0.1pF	<b>GJM0332C1E5R6BB01#</b>
				±0.25pF	<b>GJM0332C1E5R6CB01#</b>
			5.7pF	±0.05pF	<b>GJM0332C1E5R7WB01#</b>
				±0.1pF	<b>GJM0332C1E5R7BB01#</b>
				±0.25pF	<b>GJM0332C1E5R7CB01#</b>
			5.8pF	±0.05pF	<b>GJM0332C1E5R8WB01#</b>
				±0.1pF	<b>GJM0332C1E5R8BB01#</b>
				±0.25pF	<b>GJM0332C1E5R8CB01#</b>
			5.9pF	±0.05pF	<b>GJM0332C1E5R9WB01#</b>
				±0.1pF	<b>GJM0332C1E5R9BB01#</b>
				±0.25pF	<b>GJM0332C1E5R9CB01#</b>
			6.0pF	±0.05pF	<b>GJM0332C1E6R0WB01#</b>
				±0.1pF	<b>GJM0332C1E6R0BB01#</b>
				±0.25pF	<b>GJM0332C1E6R0CB01#</b>
			6.1pF	±0.05pF	<b>GJM0332C1E6R1WB01#</b>
				±0.1pF	<b>GJM0332C1E6R1BB01#</b>
				±0.25pF	<b>GJM0332C1E6R1CB01#</b>
			6.2pF	±0.05pF	<b>GJM0332C1E6R2WB01#</b>
				±0.1pF	<b>GJM0332C1E6R2BB01#</b>
				±0.25pF	<b>GJM0332C1E6R2CB01#</b>
			6.3pF	±0.05pF	<b>GJM0332C1E6R3WB01#</b>
				±0.1pF	<b>GJM0332C1E6R3BB01#</b>
				±0.25pF	<b>GJM0332C1E6R3CB01#</b>
			6.4pF	±0.05pF	<b>GJM0332C1E6R4WB01#</b>
				±0.1pF	<b>GJM0332C1E6R4BB01#</b>
				±0.25pF	<b>GJM0332C1E6R4CB01#</b>
			6.5pF	±0.05pF	<b>GJM0332C1E6R5WB01#</b>
				±0.1pF	<b>GJM0332C1E6R5BB01#</b>
				±0.25pF	<b>GJM0332C1E6R5CB01#</b>
			6.6pF	±0.05pF	<b>GJM0332C1E6R6WB01#</b>
				±0.1pF	<b>GJM0332C1E6R6BB01#</b>
				±0.25pF	<b>GJM0332C1E6R6CB01#</b>
			6.7pF	±0.05pF	<b>GJM0332C1E6R7WB01#</b>
				±0.1pF	<b>GJM0332C1E6R7BB01#</b>
				±0.25pF	<b>GJM0332C1E6R7CB01#</b>
			6.8pF	±0.05pF	<b>GJM0332C1E6R8WB01#</b>
				±0.1pF	<b>GJM0332C1E6R8BB01#</b>
				±0.25pF	<b>GJM0332C1E6R8CB01#</b>

T max.	Rated Voltage	TC Code	Cap.	Tol.	Part Number
0.33mm	25Vdc	CH	6.8pF	±0.5pF	<b>GJM0332C1E6R8DB01#</b>
				±0.05pF	<b>GJM0332C1E6R9WB01#</b>
				±0.1pF	<b>GJM0332C1E6R9BB01#</b>
			6.9pF	±0.25pF	<b>GJM0332C1E6R9CB01#</b>
				±0.5pF	<b>GJM0332C1E6R9DB01#</b>
				7.0pF	±0.05pF
			±0.1pF		<b>GJM0332C1E7R0BB01#</b>
			±0.25pF		<b>GJM0332C1E7R0CB01#</b>
			7.1pF	±0.05pF	<b>GJM0332C1E7R1WB01#</b>
				±0.1pF	<b>GJM0332C1E7R1BB01#</b>
				±0.25pF	<b>GJM0332C1E7R1CB01#</b>
			7.2pF	±0.05pF	<b>GJM0332C1E7R2WB01#</b>
				±0.1pF	<b>GJM0332C1E7R2BB01#</b>
				±0.25pF	<b>GJM0332C1E7R2CB01#</b>
			7.3pF	±0.05pF	<b>GJM0332C1E7R3WB01#</b>
				±0.1pF	<b>GJM0332C1E7R3BB01#</b>
				±0.25pF	<b>GJM0332C1E7R3CB01#</b>
			7.4pF	±0.05pF	<b>GJM0332C1E7R4WB01#</b>
				±0.1pF	<b>GJM0332C1E7R4BB01#</b>
				±0.25pF	<b>GJM0332C1E7R4CB01#</b>
			7.5pF	±0.05pF	<b>GJM0332C1E7R5WB01#</b>
				±0.1pF	<b>GJM0332C1E7R5BB01#</b>
				±0.25pF	<b>GJM0332C1E7R5CB01#</b>
			7.6pF	±0.05pF	<b>GJM0332C1E7R6WB01#</b>
				±0.1pF	<b>GJM0332C1E7R6BB01#</b>
				±0.25pF	<b>GJM0332C1E7R6CB01#</b>
			7.7pF	±0.05pF	<b>GJM0332C1E7R7WB01#</b>
				±0.1pF	<b>GJM0332C1E7R7BB01#</b>
				±0.25pF	<b>GJM0332C1E7R7CB01#</b>
			7.8pF	±0.05pF	<b>GJM0332C1E7R8WB01#</b>
				±0.1pF	<b>GJM0332C1E7R8BB01#</b>
				±0.25pF	<b>GJM0332C1E7R8CB01#</b>
			7.9pF	±0.05pF	<b>GJM0332C1E7R9WB01#</b>
				±0.1pF	<b>GJM0332C1E7R9BB01#</b>
				±0.25pF	<b>GJM0332C1E7R9CB01#</b>
			8.0pF	±0.05pF	<b>GJM0332C1E8R0WB01#</b>
				±0.1pF	<b>GJM0332C1E8R0BB01#</b>
				±0.25pF	<b>GJM0332C1E8R0CB01#</b>
			8.1pF	±0.05pF	<b>GJM0332C1E8R1WB01#</b>
				±0.1pF	<b>GJM0332C1E8R1BB01#</b>
				±0.25pF	<b>GJM0332C1E8R1CB01#</b>
			8.2pF	±0.05pF	<b>GJM0332C1E8R2WB01#</b>
				±0.1pF	<b>GJM0332C1E8R2BB01#</b>
				±0.25pF	<b>GJM0332C1E8R2CB01#</b>

Part number # indicates the package specification code.

For General Purpose GRM Series  
 Capacitor Array GNM Series  
 Low ESL LLD Series  
 High-Q Type GMI Series  
 High Frequency GQM Series  
 Monolithic Microchip GMA Series  
 For Bonding GMD Series  
 Product Information



## GJM Series Temperature Compensating Type HiQ Part Number List

(→ ■ 0.6x0.3mm)

T max.	Rated Voltage	TC Code	Cap.	Tol.	Part Number
0.33mm	25Vdc	CH	8.2pF	±0.1pF	GJM0332C1E8R2BB01#
				±0.25pF	GJM0332C1E8R2CB01#
				±0.5pF	GJM0332C1E8R2DB01#
			8.3pF	±0.05pF	GJM0332C1E8R3WB01#
				±0.1pF	GJM0332C1E8R3BB01#
				±0.25pF	GJM0332C1E8R3CB01#
			8.4pF	±0.05pF	GJM0332C1E8R4WB01#
				±0.1pF	GJM0332C1E8R4BB01#
				±0.25pF	GJM0332C1E8R4CB01#
			8.5pF	±0.05pF	GJM0332C1E8R5WB01#
				±0.1pF	GJM0332C1E8R5BB01#
				±0.25pF	GJM0332C1E8R5CB01#
			8.6pF	±0.05pF	GJM0332C1E8R6WB01#
				±0.1pF	GJM0332C1E8R6BB01#
				±0.25pF	GJM0332C1E8R6CB01#
			8.7pF	±0.05pF	GJM0332C1E8R7WB01#
				±0.1pF	GJM0332C1E8R7BB01#
				±0.25pF	GJM0332C1E8R7CB01#
			8.8pF	±0.05pF	GJM0332C1E8R8WB01#
				±0.1pF	GJM0332C1E8R8BB01#
				±0.25pF	GJM0332C1E8R8CB01#
			8.9pF	±0.05pF	GJM0332C1E8R9WB01#
				±0.1pF	GJM0332C1E8R9BB01#
				±0.25pF	GJM0332C1E8R9CB01#
			9.0pF	±0.05pF	GJM0332C1E9R0WB01#
				±0.1pF	GJM0332C1E9R0BB01#
				±0.25pF	GJM0332C1E9R0CB01#
			9.1pF	±0.05pF	GJM0332C1E9R1WB01#
				±0.1pF	GJM0332C1E9R1BB01#
				±0.25pF	GJM0332C1E9R1CB01#
			9.2pF	±0.05pF	GJM0332C1E9R2WB01#
				±0.1pF	GJM0332C1E9R2BB01#
				±0.25pF	GJM0332C1E9R2CB01#
			9.3pF	±0.05pF	GJM0332C1E9R3WB01#
				±0.1pF	GJM0332C1E9R3BB01#
				±0.25pF	GJM0332C1E9R3CB01#
			9.4pF	±0.05pF	GJM0332C1E9R4WB01#
				±0.1pF	GJM0332C1E9R4BB01#
				±0.25pF	GJM0332C1E9R4CB01#
			9.5pF	±0.05pF	GJM0332C1E9R5WB01#
				±0.1pF	GJM0332C1E9R5BB01#
				±0.25pF	GJM0332C1E9R5CB01#

T max.	Rated Voltage	TC Code	Cap.	Tol.	Part Number			
0.33mm	25Vdc	CH	9.5pF	±0.5pF	GJM0332C1E9R5DB01#			
				±0.05pF	GJM0332C1E9R6WB01#			
				±0.1pF	GJM0332C1E9R6BB01#			
			9.6pF	±0.25pF	GJM0332C1E9R6CB01#			
				±0.5pF	GJM0332C1E9R6DB01#			
				9.7pF	±0.05pF	GJM0332C1E9R7WB01#		
			±0.1pF		GJM0332C1E9R7BB01#			
			±0.25pF		GJM0332C1E9R7CB01#			
			9.8pF	±0.05pF	GJM0332C1E9R8WB01#			
				±0.1pF	GJM0332C1E9R8BB01#			
				±0.25pF	GJM0332C1E9R8CB01#			
			9.9pF	±0.05pF	GJM0332C1E9R9WB01#			
				±0.1pF	GJM0332C1E9R9BB01#			
				±0.25pF	GJM0332C1E9R9CB01#			
			10pF	±2%	GJM0332C1E100GB01#			
				±5%	GJM0332C1E100JB01#			
				11pF	±2%	GJM0332C1E110GB01#		
			±5%		GJM0332C1E110JB01#			
			12pF		±2%	GJM0332C1E120GB01#		
				±5%	GJM0332C1E120JB01#			
				13pF	±2%	GJM0332C1E130GB01#		
			±5%		GJM0332C1E130JB01#			
			15pF		±2%	GJM0332C1E150GB01#		
				±5%	GJM0332C1E150JB01#			
				16pF	±2%	GJM0332C1E160GB01#		
			±5%		GJM0332C1E160JB01#			
			18pF		±2%	GJM0332C1E180GB01#		
				±5%	GJM0332C1E180JB01#			
				20pF	±2%	GJM0332C1E200GB01#		
			±5%		GJM0332C1E200JB01#			
			6.3Vdc		C0G	22pF	±2%	GJM0335C0J220GB01#
				±5%			GJM0335C0J220JB01#	
				24pF			±2%	GJM0335C0J240GB01#
						±5%	GJM0335C0J240JB01#	
						27pF	±2%	GJM0335C0J270GB01#
				±5%			GJM0335C0J270JB01#	
				30pF			±2%	GJM0335C0J300GB01#
						±5%	GJM0335C0J300JB01#	
						33pF	±2%	GJM0335C0J330GB01#
				±5%			GJM0335C0J330JB01#	
				CH			22pF	±2%
						±5%		GJM0332C0J220JB01#
						24pF		±2%
							±5%	GJM0332C0J240JB01#
							27pF	±2%
						±5%		GJM0332C0J270JB01#
						30pF		±2%
							±5%	GJM0332C0J300JB01#
							33pF	±2%
						±5%		GJM0332C0J330JB01#

For General Purpose GRM Series

Capacitor Array GNM Series

Low ESL LLQ Series

High-Q Type GJM Series

High Frequency GQM Series

Monolithic Microchip GMA Series

For Bonding GMD Series

Product Information

Part number # indicates the package specification code.

## GJM Series Temperature Compensating Type HiQ Part Number List

### ■ 1.0x0.5mm

T max.	Rated Voltage	TC Code	Cap.	Tol.	Part Number
0.55mm	50Vdc	C0G	0.1pF	±0.05pF	GJM1555C1HR10WB01#
				±0.1pF	GJM1555C1HR10BB01#
			0.2pF	±0.05pF	GJM1555C1HR20WB01#
				±0.1pF	GJM1555C1HR20BB01#
			0.3pF	±0.05pF	GJM1555C1HR30WB01#
				±0.1pF	GJM1555C1HR30BB01#
			0.4pF	±0.05pF	GJM1555C1HR40WB01#
				±0.1pF	GJM1555C1HR40BB01#
			0.5pF	±0.05pF	GJM1555C1HR50WB01#
				±0.1pF	GJM1555C1HR50BB01#
			0.6pF	±0.05pF	GJM1555C1HR60WB01#
				±0.1pF	GJM1555C1HR60BB01#
			0.7pF	±0.05pF	GJM1555C1HR70WB01#
				±0.1pF	GJM1555C1HR70BB01#
			0.8pF	±0.05pF	GJM1555C1HR80WB01#
				±0.1pF	GJM1555C1HR80BB01#
			0.9pF	±0.05pF	GJM1555C1HR90WB01#
				±0.1pF	GJM1555C1HR90BB01#
			1.0pF	±0.05pF	GJM1555C1H1R0WB01#
				±0.1pF	GJM1555C1H1R0BB01#
				±0.25pF	GJM1555C1H1R0CB01#
			1.1pF	±0.05pF	GJM1555C1H1R1WB01#
				±0.1pF	GJM1555C1H1R1BB01#
				±0.25pF	GJM1555C1H1R1CB01#
			1.2pF	±0.05pF	GJM1555C1H1R2WB01#
				±0.1pF	GJM1555C1H1R2BB01#
				±0.25pF	GJM1555C1H1R2CB01#
			1.3pF	±0.05pF	GJM1555C1H1R3WB01#
				±0.1pF	GJM1555C1H1R3BB01#
				±0.25pF	GJM1555C1H1R3CB01#
			1.4pF	±0.05pF	GJM1555C1H1R4WB01#
				±0.1pF	GJM1555C1H1R4BB01#
				±0.25pF	GJM1555C1H1R4CB01#
			1.5pF	±0.05pF	GJM1555C1H1R5WB01#
				±0.1pF	GJM1555C1H1R5BB01#
				±0.25pF	GJM1555C1H1R5CB01#
			1.6pF	±0.05pF	GJM1555C1H1R6WB01#
				±0.1pF	GJM1555C1H1R6BB01#
				±0.25pF	GJM1555C1H1R6CB01#
			1.7pF	±0.05pF	GJM1555C1H1R7WB01#
				±0.1pF	GJM1555C1H1R7BB01#
				±0.25pF	GJM1555C1H1R7CB01#
1.8pF	±0.05pF	GJM1555C1H1R8WB01#			
	±0.1pF	GJM1555C1H1R8BB01#			
	±0.25pF	GJM1555C1H1R8CB01#			
1.9pF	±0.05pF	GJM1555C1H1R9WB01#			
	±0.1pF	GJM1555C1H1R9BB01#			
	±0.25pF	GJM1555C1H1R9CB01#			
2.0pF	±0.05pF	GJM1555C1H2R0WB01#			
	±0.1pF	GJM1555C1H2R0BB01#			
	±0.25pF	GJM1555C1H2R0CB01#			
2.1pF	±0.05pF	GJM1555C1H2R1WB01#			

T max.	Rated Voltage	TC Code	Cap.	Tol.	Part Number
0.55mm	50Vdc	C0G	2.1pF	±0.1pF	GJM1555C1H2R1BB01#
				±0.25pF	GJM1555C1H2R1CB01#
			2.2pF	±0.05pF	GJM1555C1H2R2WB01#
				±0.1pF	GJM1555C1H2R2BB01#
			2.3pF	±0.05pF	GJM1555C1H2R3WB01#
				±0.1pF	GJM1555C1H2R3BB01#
			2.4pF	±0.05pF	GJM1555C1H2R4WB01#
				±0.1pF	GJM1555C1H2R4BB01#
			2.5pF	±0.05pF	GJM1555C1H2R5WB01#
				±0.1pF	GJM1555C1H2R5BB01#
			2.6pF	±0.05pF	GJM1555C1H2R6WB01#
				±0.1pF	GJM1555C1H2R6BB01#
			2.7pF	±0.05pF	GJM1555C1H2R7WB01#
				±0.1pF	GJM1555C1H2R7BB01#
			2.8pF	±0.05pF	GJM1555C1H2R8WB01#
				±0.1pF	GJM1555C1H2R8BB01#
			2.9pF	±0.05pF	GJM1555C1H2R9WB01#
				±0.1pF	GJM1555C1H2R9BB01#
			3.0pF	±0.05pF	GJM1555C1H3R0WB01#
				±0.1pF	GJM1555C1H3R0BB01#
				±0.25pF	GJM1555C1H3R0CB01#
			3.1pF	±0.05pF	GJM1555C1H3R1WB01#
				±0.1pF	GJM1555C1H3R1BB01#
				±0.25pF	GJM1555C1H3R1CB01#
			3.2pF	±0.05pF	GJM1555C1H3R2WB01#
				±0.1pF	GJM1555C1H3R2BB01#
				±0.25pF	GJM1555C1H3R2CB01#
			3.3pF	±0.05pF	GJM1555C1H3R3WB01#
				±0.1pF	GJM1555C1H3R3BB01#
				±0.25pF	GJM1555C1H3R3CB01#
			3.4pF	±0.05pF	GJM1555C1H3R4WB01#
				±0.1pF	GJM1555C1H3R4BB01#
				±0.25pF	GJM1555C1H3R4CB01#
			3.5pF	±0.05pF	GJM1555C1H3R5WB01#
				±0.1pF	GJM1555C1H3R5BB01#
				±0.25pF	GJM1555C1H3R5CB01#
			3.6pF	±0.05pF	GJM1555C1H3R6WB01#
				±0.1pF	GJM1555C1H3R6BB01#
				±0.25pF	GJM1555C1H3R6CB01#
			3.7pF	±0.05pF	GJM1555C1H3R7WB01#
				±0.1pF	GJM1555C1H3R7BB01#
				±0.25pF	GJM1555C1H3R7CB01#
3.8pF	±0.05pF	GJM1555C1H3R8WB01#			
	±0.1pF	GJM1555C1H3R8BB01#			
	±0.25pF	GJM1555C1H3R8CB01#			
3.9pF	±0.05pF	GJM1555C1H3R9WB01#			

Part number # indicates the package specification code.

For General Purpose GRM Series  
 Capacitor Array GNM Series  
 Low ESL LL Series  
 High-Q Type GJM Series  
 High Frequency GQM Series  
 Monolithic Microchip GMA Series  
 For Bonding GMD Series  
 Product Information

## GJM Series Temperature Compensating Type HiQ Part Number List

(→ ■ 1.0x0.5mm)

T max.	Rated Voltage	TC Code	Cap.	Tol.	Part Number
0.55mm	50Vdc	C0G	3.9pF	±0.1pF	<b>GJM1555C1H3R9BB01#</b>
				±0.25pF	<b>GJM1555C1H3R9CB01#</b>
			4.0pF	±0.05pF	<b>GJM1555C1H4R0WB01#</b>
				±0.1pF	<b>GJM1555C1H4R0BB01#</b>
				±0.25pF	<b>GJM1555C1H4R0CB01#</b>
				±0.5pF	<b>GJM1555C1H4R0DB01#</b>
			4.1pF	±0.05pF	<b>GJM1555C1H4R1WB01#</b>
				±0.1pF	<b>GJM1555C1H4R1BB01#</b>
				±0.25pF	<b>GJM1555C1H4R1CB01#</b>
			4.2pF	±0.05pF	<b>GJM1555C1H4R2WB01#</b>
				±0.1pF	<b>GJM1555C1H4R2BB01#</b>
				±0.25pF	<b>GJM1555C1H4R2CB01#</b>
			4.3pF	±0.05pF	<b>GJM1555C1H4R3WB01#</b>
				±0.1pF	<b>GJM1555C1H4R3BB01#</b>
				±0.25pF	<b>GJM1555C1H4R3CB01#</b>
			4.4pF	±0.05pF	<b>GJM1555C1H4R4WB01#</b>
				±0.1pF	<b>GJM1555C1H4R4BB01#</b>
				±0.25pF	<b>GJM1555C1H4R4CB01#</b>
			4.5pF	±0.05pF	<b>GJM1555C1H4R5WB01#</b>
				±0.1pF	<b>GJM1555C1H4R5BB01#</b>
				±0.25pF	<b>GJM1555C1H4R5CB01#</b>
			4.6pF	±0.05pF	<b>GJM1555C1H4R6WB01#</b>
				±0.1pF	<b>GJM1555C1H4R6BB01#</b>
				±0.25pF	<b>GJM1555C1H4R6CB01#</b>
			4.7pF	±0.05pF	<b>GJM1555C1H4R7WB01#</b>
				±0.1pF	<b>GJM1555C1H4R7BB01#</b>
				±0.25pF	<b>GJM1555C1H4R7CB01#</b>
			4.8pF	±0.05pF	<b>GJM1555C1H4R8WB01#</b>
				±0.1pF	<b>GJM1555C1H4R8BB01#</b>
				±0.25pF	<b>GJM1555C1H4R8CB01#</b>
			4.9pF	±0.05pF	<b>GJM1555C1H4R9WB01#</b>
				±0.1pF	<b>GJM1555C1H4R9BB01#</b>
				±0.25pF	<b>GJM1555C1H4R9CB01#</b>
			5.0pF	±0.05pF	<b>GJM1555C1H5R0WB01#</b>
				±0.1pF	<b>GJM1555C1H5R0BB01#</b>
				±0.25pF	<b>GJM1555C1H5R0CB01#</b>
			5.1pF	±0.05pF	<b>GJM1555C1H5R1WB01#</b>
				±0.1pF	<b>GJM1555C1H5R1BB01#</b>
				±0.25pF	<b>GJM1555C1H5R1CB01#</b>
				±0.5pF	<b>GJM1555C1H5R1DB01#</b>
			5.2pF	±0.05pF	<b>GJM1555C1H5R2WB01#</b>
				±0.1pF	<b>GJM1555C1H5R2BB01#</b>
				±0.25pF	<b>GJM1555C1H5R2CB01#</b>
				±0.5pF	<b>GJM1555C1H5R2DB01#</b>
			5.3pF	±0.05pF	<b>GJM1555C1H5R3WB01#</b>
				±0.1pF	<b>GJM1555C1H5R3BB01#</b>
				±0.25pF	<b>GJM1555C1H5R3CB01#</b>
				±0.5pF	<b>GJM1555C1H5R3DB01#</b>
			5.4pF	±0.05pF	<b>GJM1555C1H5R4WB01#</b>
				±0.1pF	<b>GJM1555C1H5R4BB01#</b>
				±0.25pF	<b>GJM1555C1H5R4CB01#</b>
				±0.5pF	<b>GJM1555C1H5R4DB01#</b>
			5.5pF	±0.05pF	<b>GJM1555C1H5R5WB01#</b>
				±0.1pF	<b>GJM1555C1H5R5BB01#</b>
±0.25pF	<b>GJM1555C1H5R5CB01#</b>				
±0.5pF	<b>GJM1555C1H5R5DB01#</b>				

T max.	Rated Voltage	TC Code	Cap.	Tol.	Part Number
0.55mm	50Vdc	C0G	5.5pF	±0.5pF	<b>GJM1555C1H5R5DB01#</b>
				±0.05pF	<b>GJM1555C1H5R6WB01#</b>
			5.6pF	±0.1pF	<b>GJM1555C1H5R6BB01#</b>
				±0.25pF	<b>GJM1555C1H5R6CB01#</b>
				±0.5pF	<b>GJM1555C1H5R6DB01#</b>
				±0.05pF	<b>GJM1555C1H5R7WB01#</b>
			5.7pF	±0.1pF	<b>GJM1555C1H5R7BB01#</b>
				±0.25pF	<b>GJM1555C1H5R7CB01#</b>
				±0.5pF	<b>GJM1555C1H5R7DB01#</b>
			5.8pF	±0.05pF	<b>GJM1555C1H5R8WB01#</b>
				±0.1pF	<b>GJM1555C1H5R8BB01#</b>
				±0.25pF	<b>GJM1555C1H5R8CB01#</b>
			5.9pF	±0.05pF	<b>GJM1555C1H5R9WB01#</b>
				±0.1pF	<b>GJM1555C1H5R9BB01#</b>
				±0.25pF	<b>GJM1555C1H5R9CB01#</b>
			6.0pF	±0.05pF	<b>GJM1555C1H6R0WB01#</b>
				±0.1pF	<b>GJM1555C1H6R0BB01#</b>
				±0.25pF	<b>GJM1555C1H6R0CB01#</b>
			6.1pF	±0.05pF	<b>GJM1555C1H6R1WB01#</b>
				±0.1pF	<b>GJM1555C1H6R1BB01#</b>
				±0.25pF	<b>GJM1555C1H6R1CB01#</b>
			6.2pF	±0.05pF	<b>GJM1555C1H6R2WB01#</b>
				±0.1pF	<b>GJM1555C1H6R2BB01#</b>
				±0.25pF	<b>GJM1555C1H6R2CB01#</b>
			6.3pF	±0.05pF	<b>GJM1555C1H6R3WB01#</b>
				±0.1pF	<b>GJM1555C1H6R3BB01#</b>
				±0.25pF	<b>GJM1555C1H6R3CB01#</b>
			6.4pF	±0.05pF	<b>GJM1555C1H6R4WB01#</b>
				±0.1pF	<b>GJM1555C1H6R4BB01#</b>
				±0.25pF	<b>GJM1555C1H6R4CB01#</b>
			6.5pF	±0.05pF	<b>GJM1555C1H6R5WB01#</b>
				±0.1pF	<b>GJM1555C1H6R5BB01#</b>
				±0.25pF	<b>GJM1555C1H6R5CB01#</b>
			6.6pF	±0.05pF	<b>GJM1555C1H6R6WB01#</b>
				±0.1pF	<b>GJM1555C1H6R6BB01#</b>
				±0.25pF	<b>GJM1555C1H6R6CB01#</b>
			6.7pF	±0.05pF	<b>GJM1555C1H6R7WB01#</b>
				±0.1pF	<b>GJM1555C1H6R7BB01#</b>
				±0.25pF	<b>GJM1555C1H6R7CB01#</b>
			6.8pF	±0.05pF	<b>GJM1555C1H6R8WB01#</b>
				±0.1pF	<b>GJM1555C1H6R8BB01#</b>
				±0.25pF	<b>GJM1555C1H6R8CB01#</b>
			6.9pF	±0.05pF	<b>GJM1555C1H6R9WB01#</b>
				±0.1pF	<b>GJM1555C1H6R9BB01#</b>
				±0.25pF	<b>GJM1555C1H6R9CB01#</b>

Part number # indicates the package specification code.

## GJM Series Temperature Compensating Type HiQ Part Number List

(→ ■ 1.0x0.5mm)

T max.	Rated Voltage	TC Code	Cap.	Tol.	Part Number
0.55mm	50Vdc	C0G	6.9pF	±0.1pF	GJM1555C1H6R9BB01#
				±0.25pF	GJM1555C1H6R9CB01#
				±0.5pF	GJM1555C1H6R9DB01#
			7.0pF	±0.05pF	GJM1555C1H7R0WB01#
				±0.1pF	GJM1555C1H7R0BB01#
				±0.25pF	GJM1555C1H7R0CB01#
			7.1pF	±0.05pF	GJM1555C1H7R1WB01#
				±0.1pF	GJM1555C1H7R1BB01#
				±0.25pF	GJM1555C1H7R1CB01#
			7.2pF	±0.05pF	GJM1555C1H7R2WB01#
				±0.1pF	GJM1555C1H7R2BB01#
				±0.25pF	GJM1555C1H7R2CB01#
			7.3pF	±0.05pF	GJM1555C1H7R3WB01#
				±0.1pF	GJM1555C1H7R3BB01#
				±0.25pF	GJM1555C1H7R3CB01#
			7.4pF	±0.05pF	GJM1555C1H7R4WB01#
				±0.1pF	GJM1555C1H7R4BB01#
				±0.25pF	GJM1555C1H7R4CB01#
			7.5pF	±0.05pF	GJM1555C1H7R5WB01#
				±0.1pF	GJM1555C1H7R5BB01#
				±0.25pF	GJM1555C1H7R5CB01#
			7.6pF	±0.05pF	GJM1555C1H7R6WB01#
				±0.1pF	GJM1555C1H7R6BB01#
				±0.25pF	GJM1555C1H7R6CB01#
			7.7pF	±0.05pF	GJM1555C1H7R7WB01#
				±0.1pF	GJM1555C1H7R7BB01#
				±0.25pF	GJM1555C1H7R7CB01#
			7.8pF	±0.05pF	GJM1555C1H7R8WB01#
				±0.1pF	GJM1555C1H7R8BB01#
				±0.25pF	GJM1555C1H7R8CB01#
			7.9pF	±0.05pF	GJM1555C1H7R9WB01#
				±0.1pF	GJM1555C1H7R9BB01#
				±0.25pF	GJM1555C1H7R9CB01#
			8.0pF	±0.05pF	GJM1555C1H8R0WB01#
				±0.1pF	GJM1555C1H8R0BB01#
				±0.25pF	GJM1555C1H8R0CB01#
			8.1pF	±0.05pF	GJM1555C1H8R1WB01#
				±0.1pF	GJM1555C1H8R1BB01#
				±0.25pF	GJM1555C1H8R1CB01#
			8.2pF	±0.05pF	GJM1555C1H8R2WB01#
				±0.1pF	GJM1555C1H8R2BB01#
				±0.25pF	GJM1555C1H8R2CB01#

T max.	Rated Voltage	TC Code	Cap.	Tol.	Part Number
0.55mm	50Vdc	C0G	8.2pF	±0.5pF	GJM1555C1H8R2DB01#
				±0.05pF	GJM1555C1H8R3WB01#
				±0.1pF	GJM1555C1H8R3BB01#
			8.3pF	±0.25pF	GJM1555C1H8R3CB01#
				±0.5pF	GJM1555C1H8R3DB01#
				8.4pF	±0.05pF
			±0.1pF		GJM1555C1H8R4BB01#
			±0.25pF		GJM1555C1H8R4CB01#
			8.5pF	±0.05pF	GJM1555C1H8R5WB01#
				±0.1pF	GJM1555C1H8R5BB01#
				±0.25pF	GJM1555C1H8R5CB01#
			8.6pF	±0.05pF	GJM1555C1H8R6WB01#
				±0.1pF	GJM1555C1H8R6BB01#
				±0.25pF	GJM1555C1H8R6CB01#
			8.7pF	±0.05pF	GJM1555C1H8R7WB01#
				±0.1pF	GJM1555C1H8R7BB01#
				±0.25pF	GJM1555C1H8R7CB01#
			8.8pF	±0.05pF	GJM1555C1H8R8WB01#
				±0.1pF	GJM1555C1H8R8BB01#
				±0.25pF	GJM1555C1H8R8CB01#
			8.9pF	±0.05pF	GJM1555C1H8R9WB01#
				±0.1pF	GJM1555C1H8R9BB01#
				±0.25pF	GJM1555C1H8R9CB01#
			9.0pF	±0.05pF	GJM1555C1H9R0WB01#
				±0.1pF	GJM1555C1H9R0BB01#
				±0.25pF	GJM1555C1H9R0CB01#
			9.1pF	±0.05pF	GJM1555C1H9R1WB01#
				±0.1pF	GJM1555C1H9R1BB01#
				±0.25pF	GJM1555C1H9R1CB01#
			9.2pF	±0.05pF	GJM1555C1H9R2WB01#
				±0.1pF	GJM1555C1H9R2BB01#
				±0.25pF	GJM1555C1H9R2CB01#
			9.3pF	±0.05pF	GJM1555C1H9R3WB01#
				±0.1pF	GJM1555C1H9R3BB01#
				±0.25pF	GJM1555C1H9R3CB01#
			9.4pF	±0.05pF	GJM1555C1H9R4WB01#
				±0.1pF	GJM1555C1H9R4BB01#
				±0.25pF	GJM1555C1H9R4CB01#
			9.5pF	±0.05pF	GJM1555C1H9R5WB01#
				±0.1pF	GJM1555C1H9R5BB01#
				±0.25pF	GJM1555C1H9R5CB01#
			9.6pF	±0.05pF	GJM1555C1H9R6WB01#
				±0.1pF	GJM1555C1H9R6BB01#
				±0.25pF	GJM1555C1H9R6CB01#

Part number # indicates the package specification code.

For General Purpose GRM Series  
 Capacitor Array GNM Series  
 Low ESL LL Series  
 High-Q Type GMI Series  
 High Frequency GQM Series  
 Monolithic Microchip GMA Series  
 For Bonding GMD Series  
 Product Information



## GJM Series Temperature Compensating Type HiQ Part Number List

(→ ■ 1.0x0.5mm)

T max.	Rated Voltage	TC Code	Cap.	Tol.	Part Number
0.55mm	50Vdc	C0G	9.6pF	±0.1pF	<b>GJM1555C1H9R6BB01#</b>
				±0.25pF	<b>GJM1555C1H9R6CB01#</b>
				±0.5pF	<b>GJM1555C1H9R6DB01#</b>
			9.7pF	±0.05pF	<b>GJM1555C1H9R7WB01#</b>
				±0.1pF	<b>GJM1555C1H9R7BB01#</b>
				±0.25pF	<b>GJM1555C1H9R7CB01#</b>
			9.8pF	±0.05pF	<b>GJM1555C1H9R8WB01#</b>
				±0.1pF	<b>GJM1555C1H9R8BB01#</b>
				±0.25pF	<b>GJM1555C1H9R8CB01#</b>
			9.9pF	±0.05pF	<b>GJM1555C1H9R9WB01#</b>
				±0.1pF	<b>GJM1555C1H9R9BB01#</b>
				±0.25pF	<b>GJM1555C1H9R9CB01#</b>
			10pF	±0.05pF	<b>GJM1555C1H9R9DB01#</b>
				±0.1pF	<b>GJM1555C1H100GB01#</b>
				±0.25pF	<b>GJM1555C1H100JB01#</b>
			11pF	±2%	<b>GJM1555C1H110GB01#</b>
				±5%	<b>GJM1555C1H110JB01#</b>
			12pF	±2%	<b>GJM1555C1H120GB01#</b>
				±5%	<b>GJM1555C1H120JB01#</b>
			13pF	±2%	<b>GJM1555C1H130GB01#</b>
				±5%	<b>GJM1555C1H130JB01#</b>
			15pF	±2%	<b>GJM1555C1H150GB01#</b>
				±5%	<b>GJM1555C1H150JB01#</b>
			16pF	±2%	<b>GJM1555C1H160GB01#</b>
				±5%	<b>GJM1555C1H160JB01#</b>
			18pF	±2%	<b>GJM1555C1H180GB01#</b>
				±5%	<b>GJM1555C1H180JB01#</b>
			20pF	±2%	<b>GJM1555C1H200GB01#</b>
				±5%	<b>GJM1555C1H200JB01#</b>
			22pF	±1%	<b>GJM1555C1H220FB01#</b>
				±2%	<b>GJM1555C1H220GB01#</b>
				±5%	<b>GJM1555C1H220JB01#</b>
			24pF	±1%	<b>GJM1555C1H240FB01#</b>
				±2%	<b>GJM1555C1H240GB01#</b>
				±5%	<b>GJM1555C1H240JB01#</b>
			27pF	±1%	<b>GJM1555C1H270FB01#</b>
				±2%	<b>GJM1555C1H270GB01#</b>
				±5%	<b>GJM1555C1H270JB01#</b>
			30pF	±1%	<b>GJM1555C1H300FB01#</b>
				±2%	<b>GJM1555C1H300GB01#</b>
				±5%	<b>GJM1555C1H300JB01#</b>
			33pF	±1%	<b>GJM1555C1H330FB01#</b>
				±2%	<b>GJM1555C1H330GB01#</b>
				±5%	<b>GJM1555C1H330JB01#</b>
			36pF	±1%	<b>GJM1555C1H360FB01#</b>
				±2%	<b>GJM1555C1H360GB01#</b>
				±5%	<b>GJM1555C1H360JB01#</b>
			39pF	±1%	<b>GJM1555C1H390FB01#</b>
				±2%	<b>GJM1555C1H390GB01#</b>
				±5%	<b>GJM1555C1H390JB01#</b>
			43pF	±1%	<b>GJM1555C1H430FB01#</b>
				±2%	<b>GJM1555C1H430GB01#</b>

T max.	Rated Voltage	TC Code	Cap.	Tol.	Part Number	
0.55mm	50Vdc	C0G	43pF	±5%	<b>GJM1555C1H430JB01#</b>	
				±1%	<b>GJM1555C1H470FB01#</b>	
				±2%	<b>GJM1555C1H470GB01#</b>	
			47pF	±5%	<b>GJM1555C1H470JB01#</b>	
				0.1pF	±0.05pF	<b>GJM1554C1HR10WB01#</b>
					±0.1pF	<b>GJM1554C1HR10BB01#</b>
			0.2pF	±0.05pF	<b>GJM1554C1HR20WB01#</b>	
				±0.1pF	<b>GJM1554C1HR20BB01#</b>	
			0.3pF	±0.05pF	<b>GJM1554C1HR30WB01#</b>	
				±0.1pF	<b>GJM1554C1HR30BB01#</b>	
			0.4pF	±0.05pF	<b>GJM1554C1HR40WB01#</b>	
				±0.1pF	<b>GJM1554C1HR40BB01#</b>	
		0.5pF	±0.05pF	<b>GJM1554C1HR50WB01#</b>		
			±0.1pF	<b>GJM1554C1HR50BB01#</b>		
		0.6pF	±0.05pF	<b>GJM1554C1HR60WB01#</b>		
			±0.1pF	<b>GJM1554C1HR60BB01#</b>		
		0.7pF	±0.05pF	<b>GJM1554C1HR70WB01#</b>		
			±0.1pF	<b>GJM1554C1HR70BB01#</b>		
		0.8pF	±0.05pF	<b>GJM1554C1HR80WB01#</b>		
			±0.1pF	<b>GJM1554C1HR80BB01#</b>		
		0.9pF	±0.05pF	<b>GJM1554C1HR90WB01#</b>		
			±0.1pF	<b>GJM1554C1HR90BB01#</b>		
		1.0pF	±0.05pF	<b>GJM1554C1H1R0WB01#</b>		
			±0.1pF	<b>GJM1554C1H1R0BB01#</b>		
			±0.25pF	<b>GJM1554C1H1R0CB01#</b>		
		1.1pF	±0.05pF	<b>GJM1554C1H1R1WB01#</b>		
			±0.1pF	<b>GJM1554C1H1R1BB01#</b>		
			±0.25pF	<b>GJM1554C1H1R1CB01#</b>		
		1.2pF	±0.05pF	<b>GJM1554C1H1R2WB01#</b>		
			±0.1pF	<b>GJM1554C1H1R2BB01#</b>		
			±0.25pF	<b>GJM1554C1H1R2CB01#</b>		
		1.3pF	±0.05pF	<b>GJM1554C1H1R3WB01#</b>		
			±0.1pF	<b>GJM1554C1H1R3BB01#</b>		
			±0.25pF	<b>GJM1554C1H1R3CB01#</b>		
		1.4pF	±0.05pF	<b>GJM1554C1H1R4WB01#</b>		
			±0.1pF	<b>GJM1554C1H1R4BB01#</b>		
			±0.25pF	<b>GJM1554C1H1R4CB01#</b>		
		1.5pF	±0.05pF	<b>GJM1554C1H1R5WB01#</b>		
			±0.1pF	<b>GJM1554C1H1R5BB01#</b>		
			±0.25pF	<b>GJM1554C1H1R5CB01#</b>		
		1.6pF	±0.05pF	<b>GJM1554C1H1R6WB01#</b>		
			±0.1pF	<b>GJM1554C1H1R6BB01#</b>		
±0.25pF	<b>GJM1554C1H1R6CB01#</b>					
1.7pF	±0.05pF	<b>GJM1554C1H1R7WB01#</b>				
	±0.1pF	<b>GJM1554C1H1R7BB01#</b>				
	±0.25pF	<b>GJM1554C1H1R7CB01#</b>				
1.8pF	±0.05pF	<b>GJM1554C1H1R8WB01#</b>				
	±0.1pF	<b>GJM1554C1H1R8BB01#</b>				
	±0.25pF	<b>GJM1554C1H1R8CB01#</b>				
1.9pF	±0.05pF	<b>GJM1554C1H1R9WB01#</b>				
	±0.1pF	<b>GJM1554C1H1R9BB01#</b>				
	±0.25pF	<b>GJM1554C1H1R9CB01#</b>				
2.0pF	±0.05pF	<b>GJM1554C1H2R0WB01#</b>				
	±0.1pF	<b>GJM1554C1H2R0BB01#</b>				

For General Purpose GRM Series  
 Capacitor Array GNM Series  
 Low ESL LL□ Series  
 High-Q Type GJM Series  
 High Frequency GQM Series  
 Monolithic Microchip GMA Series  
 For Bonding GMD Series  
 Product Information

Part number # indicates the package specification code.



## GJM Series Temperature Compensating Type HiQ Part Number List

(→ ■ 1.0x0.5mm)

T max.	Rated Voltage	TC Code	Cap.	Tol.	Part Number
0.55mm	50Vdc	CK	2.0pF	±0.25pF	<b>GJM1554C1H2R0CB01#</b>
				±0.05pF	<b>GJM1553C1H2R1WB01#</b>
		CJ	2.1pF	±0.05pF	<b>GJM1553C1H2R1WB01#</b>
				±0.1pF	<b>GJM1553C1H2R1BB01#</b>
				±0.25pF	<b>GJM1553C1H2R1CB01#</b>
				±0.05pF	<b>GJM1553C1H2R2WB01#</b>
			2.2pF	±0.1pF	<b>GJM1553C1H2R2BB01#</b>
				±0.25pF	<b>GJM1553C1H2R2CB01#</b>
				±0.05pF	<b>GJM1553C1H2R3WB01#</b>
			2.3pF	±0.1pF	<b>GJM1553C1H2R3BB01#</b>
				±0.25pF	<b>GJM1553C1H2R3CB01#</b>
				±0.05pF	<b>GJM1553C1H2R4WB01#</b>
			2.4pF	±0.1pF	<b>GJM1553C1H2R4BB01#</b>
				±0.25pF	<b>GJM1553C1H2R4CB01#</b>
		±0.05pF		<b>GJM1553C1H2R5WB01#</b>	
		2.5pF	±0.1pF	<b>GJM1553C1H2R5BB01#</b>	
			±0.25pF	<b>GJM1553C1H2R5CB01#</b>	
			±0.05pF	<b>GJM1553C1H2R6WB01#</b>	
		2.6pF	±0.1pF	<b>GJM1553C1H2R6BB01#</b>	
			±0.25pF	<b>GJM1553C1H2R6CB01#</b>	
			±0.05pF	<b>GJM1553C1H2R7WB01#</b>	
		2.7pF	±0.1pF	<b>GJM1553C1H2R7BB01#</b>	
			±0.25pF	<b>GJM1553C1H2R7CB01#</b>	
			±0.05pF	<b>GJM1553C1H2R8WB01#</b>	
		2.8pF	±0.1pF	<b>GJM1553C1H2R8BB01#</b>	
			±0.25pF	<b>GJM1553C1H2R8CB01#</b>	
			±0.05pF	<b>GJM1553C1H2R9WB01#</b>	
		2.9pF	±0.1pF	<b>GJM1553C1H2R9BB01#</b>	
			±0.25pF	<b>GJM1553C1H2R9CB01#</b>	
			±0.05pF	<b>GJM1553C1H3R0WB01#</b>	
		3.0pF	±0.1pF	<b>GJM1553C1H3R0BB01#</b>	
			±0.25pF	<b>GJM1553C1H3R0CB01#</b>	
			±0.05pF	<b>GJM1553C1H3R1WB01#</b>	
		3.1pF	±0.1pF	<b>GJM1553C1H3R1BB01#</b>	
			±0.25pF	<b>GJM1553C1H3R1CB01#</b>	
			±0.05pF	<b>GJM1553C1H3R2WB01#</b>	
		3.2pF	±0.1pF	<b>GJM1553C1H3R2BB01#</b>	
			±0.25pF	<b>GJM1553C1H3R2CB01#</b>	
			±0.05pF	<b>GJM1553C1H3R3WB01#</b>	
		3.3pF	±0.1pF	<b>GJM1553C1H3R3BB01#</b>	
			±0.25pF	<b>GJM1553C1H3R3CB01#</b>	
			±0.05pF	<b>GJM1553C1H3R4WB01#</b>	
		3.4pF	±0.1pF	<b>GJM1553C1H3R4BB01#</b>	
			±0.25pF	<b>GJM1553C1H3R4CB01#</b>	
			±0.05pF	<b>GJM1553C1H3R5WB01#</b>	
		3.5pF	±0.1pF	<b>GJM1553C1H3R5BB01#</b>	
			±0.25pF	<b>GJM1553C1H3R5CB01#</b>	
			±0.05pF	<b>GJM1553C1H3R6WB01#</b>	
		3.6pF	±0.1pF	<b>GJM1553C1H3R6BB01#</b>	
			±0.25pF	<b>GJM1553C1H3R6CB01#</b>	
			±0.05pF	<b>GJM1553C1H3R7WB01#</b>	
		3.7pF	±0.1pF	<b>GJM1553C1H3R7BB01#</b>	
			±0.25pF	<b>GJM1553C1H3R7CB01#</b>	
			±0.05pF	<b>GJM1553C1H3R8WB01#</b>	
		3.8pF	±0.1pF	<b>GJM1553C1H3R8BB01#</b>	

T max.	Rated Voltage	TC Code	Cap.	Tol.	Part Number	
0.55mm	50Vdc	CJ	3.8pF	±0.25pF	<b>GJM1553C1H3R8CB01#</b>	
				±0.05pF	<b>GJM1553C1H3R9WB01#</b>	
				±0.1pF	<b>GJM1553C1H3R9BB01#</b>	
				±0.25pF	<b>GJM1553C1H3R9CB01#</b>	
			CH	4.0pF	±0.05pF	<b>GJM1552C1H4R0WB01#</b>
					±0.1pF	<b>GJM1552C1H4R0BB01#</b>
					±0.25pF	<b>GJM1552C1H4R0CB01#</b>
					±0.05pF	<b>GJM1552C1H4R1WB01#</b>
				4.1pF	±0.1pF	<b>GJM1552C1H4R1BB01#</b>
					±0.25pF	<b>GJM1552C1H4R1CB01#</b>
					±0.05pF	<b>GJM1552C1H4R2WB01#</b>
				4.2pF	±0.1pF	<b>GJM1552C1H4R2BB01#</b>
		±0.25pF			<b>GJM1552C1H4R2CB01#</b>	
		±0.05pF			<b>GJM1552C1H4R3WB01#</b>	
		4.3pF		±0.1pF	<b>GJM1552C1H4R3BB01#</b>	
				±0.25pF	<b>GJM1552C1H4R3CB01#</b>	
			±0.05pF	<b>GJM1552C1H4R4WB01#</b>		
		4.4pF	±0.1pF	<b>GJM1552C1H4R4BB01#</b>		
			±0.25pF	<b>GJM1552C1H4R4CB01#</b>		
			±0.05pF	<b>GJM1552C1H4R5WB01#</b>		
		4.5pF	±0.1pF	<b>GJM1552C1H4R5BB01#</b>		
			±0.25pF	<b>GJM1552C1H4R5CB01#</b>		
			±0.05pF	<b>GJM1552C1H4R6WB01#</b>		
		4.6pF	±0.1pF	<b>GJM1552C1H4R6BB01#</b>		
			±0.25pF	<b>GJM1552C1H4R6CB01#</b>		
			±0.05pF	<b>GJM1552C1H4R7WB01#</b>		
		4.7pF	±0.1pF	<b>GJM1552C1H4R7BB01#</b>		
			±0.25pF	<b>GJM1552C1H4R7CB01#</b>		
			±0.05pF	<b>GJM1552C1H4R8WB01#</b>		
		4.8pF	±0.1pF	<b>GJM1552C1H4R8BB01#</b>		
			±0.25pF	<b>GJM1552C1H4R8CB01#</b>		
			±0.05pF	<b>GJM1552C1H4R9WB01#</b>		
		4.9pF	±0.1pF	<b>GJM1552C1H4R9BB01#</b>		
			±0.25pF	<b>GJM1552C1H4R9CB01#</b>		
			±0.05pF	<b>GJM1552C1H5R0WB01#</b>		
		5.0pF	±0.1pF	<b>GJM1552C1H5R0BB01#</b>		
			±0.25pF	<b>GJM1552C1H5R0CB01#</b>		
			±0.05pF	<b>GJM1552C1H5R1WB01#</b>		
		5.1pF	±0.1pF	<b>GJM1552C1H5R1BB01#</b>		
			±0.25pF	<b>GJM1552C1H5R1CB01#</b>		
			±0.5pF	<b>GJM1552C1H5R1DB01#</b>		
		5.2pF	±0.05pF	<b>GJM1552C1H5R2WB01#</b>		
			±0.1pF	<b>GJM1552C1H5R2BB01#</b>		
			±0.25pF	<b>GJM1552C1H5R2CB01#</b>		
		5.3pF	±0.5pF	<b>GJM1552C1H5R2DB01#</b>		
			±0.05pF	<b>GJM1552C1H5R3WB01#</b>		
			±0.1pF	<b>GJM1552C1H5R3BB01#</b>		
		5.4pF	±0.25pF	<b>GJM1552C1H5R3CB01#</b>		
			±0.5pF	<b>GJM1552C1H5R3DB01#</b>		
			±0.05pF	<b>GJM1552C1H5R4WB01#</b>		
		5.5pF	±0.1pF	<b>GJM1552C1H5R4BB01#</b>		
			±0.25pF	<b>GJM1552C1H5R4CB01#</b>		
			±0.5pF	<b>GJM1552C1H5R4DB01#</b>		
		5.5pF	±0.05pF	<b>GJM1552C1H5R5WB01#</b>		

Part number # indicates the package specification code.

For General Purpose GRM Series  
 Capacitor Array GNM Series  
 Low ESL LL Series  
 High-Q Type GJM Series  
 High Frequency GQM Series  
 Monolithic Microchip GMA Series  
 For Bonding GMD Series  
 Product Information

## GJM Series Temperature Compensating Type HiQ Part Number List

(→ ■ 1.0x0.5mm)

T max.	Rated Voltage	TC Code	Cap.	Tol.	Part Number
0.55mm	50Vdc	CH	5.5pF	±0.1pF	GJM1552C1H5R5BB01#
				±0.25pF	GJM1552C1H5R5CB01#
				±0.5pF	GJM1552C1H5R5DB01#
			5.6pF	±0.05pF	GJM1552C1H5R6WB01#
				±0.1pF	GJM1552C1H5R6BB01#
				±0.25pF	GJM1552C1H5R6CB01#
			5.7pF	±0.05pF	GJM1552C1H5R7WB01#
				±0.1pF	GJM1552C1H5R7BB01#
				±0.25pF	GJM1552C1H5R7CB01#
			5.8pF	±0.05pF	GJM1552C1H5R8WB01#
				±0.1pF	GJM1552C1H5R8BB01#
				±0.25pF	GJM1552C1H5R8CB01#
			5.9pF	±0.05pF	GJM1552C1H5R9WB01#
				±0.1pF	GJM1552C1H5R9BB01#
				±0.25pF	GJM1552C1H5R9CB01#
			6.0pF	±0.05pF	GJM1552C1H6R0WB01#
				±0.1pF	GJM1552C1H6R0BB01#
				±0.25pF	GJM1552C1H6R0CB01#
			6.1pF	±0.05pF	GJM1552C1H6R1WB01#
				±0.1pF	GJM1552C1H6R1BB01#
				±0.25pF	GJM1552C1H6R1CB01#
			6.2pF	±0.05pF	GJM1552C1H6R2WB01#
				±0.1pF	GJM1552C1H6R2BB01#
				±0.25pF	GJM1552C1H6R2CB01#
			6.3pF	±0.05pF	GJM1552C1H6R3WB01#
				±0.1pF	GJM1552C1H6R3BB01#
				±0.25pF	GJM1552C1H6R3CB01#
			6.4pF	±0.05pF	GJM1552C1H6R4WB01#
				±0.1pF	GJM1552C1H6R4BB01#
				±0.25pF	GJM1552C1H6R4CB01#
			6.5pF	±0.05pF	GJM1552C1H6R5WB01#
				±0.1pF	GJM1552C1H6R5BB01#
				±0.25pF	GJM1552C1H6R5CB01#
			6.6pF	±0.05pF	GJM1552C1H6R6WB01#
				±0.1pF	GJM1552C1H6R6BB01#
				±0.25pF	GJM1552C1H6R6CB01#
			6.7pF	±0.05pF	GJM1552C1H6R7WB01#
				±0.1pF	GJM1552C1H6R7BB01#
				±0.25pF	GJM1552C1H6R7CB01#
			6.8pF	±0.05pF	GJM1552C1H6R8WB01#
				±0.1pF	GJM1552C1H6R8BB01#
				±0.25pF	GJM1552C1H6R8CB01#

T max.	Rated Voltage	TC Code	Cap.	Tol.	Part Number
0.55mm	50Vdc	CH	6.8pF	±0.5pF	GJM1552C1H6R8DB01#
				±0.05pF	GJM1552C1H6R9WB01#
				±0.1pF	GJM1552C1H6R9BB01#
			6.9pF	±0.25pF	GJM1552C1H6R9CB01#
				±0.5pF	GJM1552C1H6R9DB01#
				7.0pF	±0.05pF
			±0.1pF		GJM1552C1H7R0BB01#
			±0.25pF		GJM1552C1H7R0CB01#
			7.1pF	±0.05pF	GJM1552C1H7R1WB01#
				±0.1pF	GJM1552C1H7R1BB01#
				±0.25pF	GJM1552C1H7R1CB01#
			7.2pF	±0.05pF	GJM1552C1H7R2WB01#
				±0.1pF	GJM1552C1H7R2BB01#
				±0.25pF	GJM1552C1H7R2CB01#
			7.3pF	±0.05pF	GJM1552C1H7R3WB01#
				±0.1pF	GJM1552C1H7R3BB01#
				±0.25pF	GJM1552C1H7R3CB01#
			7.4pF	±0.05pF	GJM1552C1H7R4WB01#
				±0.1pF	GJM1552C1H7R4BB01#
				±0.25pF	GJM1552C1H7R4CB01#
			7.5pF	±0.05pF	GJM1552C1H7R5WB01#
				±0.1pF	GJM1552C1H7R5BB01#
				±0.25pF	GJM1552C1H7R5CB01#
			7.6pF	±0.05pF	GJM1552C1H7R6WB01#
				±0.1pF	GJM1552C1H7R6BB01#
				±0.25pF	GJM1552C1H7R6CB01#
			7.7pF	±0.05pF	GJM1552C1H7R7WB01#
				±0.1pF	GJM1552C1H7R7BB01#
				±0.25pF	GJM1552C1H7R7CB01#
			7.8pF	±0.05pF	GJM1552C1H7R8WB01#
				±0.1pF	GJM1552C1H7R8BB01#
				±0.25pF	GJM1552C1H7R8CB01#
			7.9pF	±0.05pF	GJM1552C1H7R9WB01#
				±0.1pF	GJM1552C1H7R9BB01#
				±0.25pF	GJM1552C1H7R9CB01#
			8.0pF	±0.05pF	GJM1552C1H8R0WB01#
				±0.1pF	GJM1552C1H8R0BB01#
				±0.25pF	GJM1552C1H8R0CB01#
			8.1pF	±0.05pF	GJM1552C1H8R1WB01#
				±0.1pF	GJM1552C1H8R1BB01#
				±0.25pF	GJM1552C1H8R1CB01#
			8.2pF	±0.05pF	GJM1552C1H8R2WB01#
				±0.1pF	GJM1552C1H8R2BB01#
				±0.25pF	GJM1552C1H8R2CB01#

Part number # indicates the package specification code.

## GJM Series Temperature Compensating Type HiQ Part Number List

(→ ■ 1.0x0.5mm)

T max.	Rated Voltage	TC Code	Cap.	Tol.	Part Number
0.55mm	50Vdc	CH	8.2pF	±0.1pF	<b>GJM1552C1H8R2BB01#</b>
				±0.25pF	<b>GJM1552C1H8R2CB01#</b>
				±0.5pF	<b>GJM1552C1H8R2DB01#</b>
			8.3pF	±0.05pF	<b>GJM1552C1H8R3WB01#</b>
				±0.1pF	<b>GJM1552C1H8R3BB01#</b>
				±0.25pF	<b>GJM1552C1H8R3CB01#</b>
			8.4pF	±0.05pF	<b>GJM1552C1H8R4WB01#</b>
				±0.1pF	<b>GJM1552C1H8R4BB01#</b>
				±0.25pF	<b>GJM1552C1H8R4CB01#</b>
			8.5pF	±0.05pF	<b>GJM1552C1H8R5WB01#</b>
				±0.1pF	<b>GJM1552C1H8R5BB01#</b>
				±0.25pF	<b>GJM1552C1H8R5CB01#</b>
			8.6pF	±0.05pF	<b>GJM1552C1H8R6WB01#</b>
				±0.1pF	<b>GJM1552C1H8R6BB01#</b>
				±0.25pF	<b>GJM1552C1H8R6CB01#</b>
			8.7pF	±0.05pF	<b>GJM1552C1H8R7WB01#</b>
				±0.1pF	<b>GJM1552C1H8R7BB01#</b>
				±0.25pF	<b>GJM1552C1H8R7CB01#</b>
			8.8pF	±0.05pF	<b>GJM1552C1H8R8WB01#</b>
				±0.1pF	<b>GJM1552C1H8R8BB01#</b>
				±0.25pF	<b>GJM1552C1H8R8CB01#</b>
			8.9pF	±0.05pF	<b>GJM1552C1H8R9WB01#</b>
				±0.1pF	<b>GJM1552C1H8R9BB01#</b>
				±0.25pF	<b>GJM1552C1H8R9CB01#</b>
			9.0pF	±0.05pF	<b>GJM1552C1H9R0WB01#</b>
				±0.1pF	<b>GJM1552C1H9R0BB01#</b>
				±0.25pF	<b>GJM1552C1H9R0CB01#</b>
			9.1pF	±0.05pF	<b>GJM1552C1H9R1WB01#</b>
				±0.1pF	<b>GJM1552C1H9R1BB01#</b>
				±0.25pF	<b>GJM1552C1H9R1CB01#</b>
			9.2pF	±0.05pF	<b>GJM1552C1H9R2WB01#</b>
				±0.1pF	<b>GJM1552C1H9R2BB01#</b>
				±0.25pF	<b>GJM1552C1H9R2CB01#</b>
			9.3pF	±0.05pF	<b>GJM1552C1H9R3WB01#</b>
				±0.1pF	<b>GJM1552C1H9R3BB01#</b>
				±0.25pF	<b>GJM1552C1H9R3CB01#</b>
			9.4pF	±0.05pF	<b>GJM1552C1H9R4WB01#</b>
				±0.1pF	<b>GJM1552C1H9R4BB01#</b>
				±0.25pF	<b>GJM1552C1H9R4CB01#</b>
			9.5pF	±0.05pF	<b>GJM1552C1H9R5WB01#</b>
				±0.1pF	<b>GJM1552C1H9R5BB01#</b>
				±0.25pF	<b>GJM1552C1H9R5CB01#</b>

T max.	Rated Voltage	TC Code	Cap.	Tol.	Part Number
0.55mm	50Vdc	CH	9.5pF	±0.5pF	<b>GJM1552C1H9R5DB01#</b>
				±0.05pF	<b>GJM1552C1H9R6WB01#</b>
				±0.1pF	<b>GJM1552C1H9R6BB01#</b>
			9.6pF	±0.25pF	<b>GJM1552C1H9R6CB01#</b>
				±0.5pF	<b>GJM1552C1H9R6DB01#</b>
				9.7pF	±0.05pF
			±0.1pF		<b>GJM1552C1H9R7BB01#</b>
			±0.25pF		<b>GJM1552C1H9R7CB01#</b>
			9.8pF	±0.05pF	<b>GJM1552C1H9R8WB01#</b>
				±0.1pF	<b>GJM1552C1H9R8BB01#</b>
				±0.25pF	<b>GJM1552C1H9R8CB01#</b>
			9.9pF	±0.05pF	<b>GJM1552C1H9R9WB01#</b>
				±0.1pF	<b>GJM1552C1H9R9BB01#</b>
				±0.25pF	<b>GJM1552C1H9R9CB01#</b>
			10pF	±2%	<b>GJM1552C1H100GB01#</b>
				±5%	<b>GJM1552C1H100JB01#</b>
			11pF	±2%	<b>GJM1552C1H110GB01#</b>
				±5%	<b>GJM1552C1H110JB01#</b>
			12pF	±2%	<b>GJM1552C1H120GB01#</b>
				±5%	<b>GJM1552C1H120JB01#</b>
			13pF	±2%	<b>GJM1552C1H130GB01#</b>
				±5%	<b>GJM1552C1H130JB01#</b>
			15pF	±2%	<b>GJM1552C1H150GB01#</b>
				±5%	<b>GJM1552C1H150JB01#</b>
			16pF	±2%	<b>GJM1552C1H160GB01#</b>
				±5%	<b>GJM1552C1H160JB01#</b>
			18pF	±2%	<b>GJM1552C1H180GB01#</b>
				±5%	<b>GJM1552C1H180JB01#</b>
			20pF	±2%	<b>GJM1552C1H200GB01#</b>
				±5%	<b>GJM1552C1H200JB01#</b>
			22pF	±1%	<b>GJM1552C1H220FB01#</b>
				±2%	<b>GJM1552C1H220GB01#</b>
				±5%	<b>GJM1552C1H220JB01#</b>
			24pF	±1%	<b>GJM1552C1H240FB01#</b>
				±2%	<b>GJM1552C1H240GB01#</b>
				±5%	<b>GJM1552C1H240JB01#</b>
			27pF	±1%	<b>GJM1552C1H270FB01#</b>
				±2%	<b>GJM1552C1H270GB01#</b>
				±5%	<b>GJM1552C1H270JB01#</b>
			30pF	±1%	<b>GJM1552C1H300FB01#</b>
				±2%	<b>GJM1552C1H300GB01#</b>
				±5%	<b>GJM1552C1H300JB01#</b>
			33pF	±1%	<b>GJM1552C1H330FB01#</b>
				±2%	<b>GJM1552C1H330GB01#</b>
				±5%	<b>GJM1552C1H330JB01#</b>
36pF	±1%	<b>GJM1552C1H360FB01#</b>			
	±2%	<b>GJM1552C1H360GB01#</b>			
	±5%	<b>GJM1552C1H360JB01#</b>			
39pF	±1%	<b>GJM1552C1H390FB01#</b>			
	±2%	<b>GJM1552C1H390GB01#</b>			
	±5%	<b>GJM1552C1H390JB01#</b>			

Part number # indicates the package specification code.

For General Purpose GRM Series  
 Capacitor Array GNM Series  
 Low ESL LL Series  
 High-Q Type GJM Series  
 High Frequency GQM Series  
 Monolithic Microchip GMA Series  
 For Bonding GMD Series  
 Product Information

## GJM Series Temperature Compensating Type HiQ Part Number List

(→ ■ 1.0x0.5mm)

T max.	Rated Voltage	TC Code	Cap.	Tol.	Part Number	
0.55mm	50Vdc	CH	43pF	±1%	<b>GJM1552C1H430FB01#</b>	
				±2%	<b>GJM1552C1H430GB01#</b>	
				±5%	<b>GJM1552C1H430JB01#</b>	
			47pF	±1%	<b>GJM1552C1H470FB01#</b>	
				±2%	<b>GJM1552C1H470GB01#</b>	
				±5%	<b>GJM1552C1H470JB01#</b>	

For General Purpose  
GRM Series

Capacitor Array  
GNM Series

Low ESL  
LLQ Series

High-Q Type  
GJM Series

High Frequency  
GQM Series

Monolithic Microchip  
GMA Series

For Bonding  
GMD Series

Product Information

Part number # indicates the package specification code.

## Chip Monolithic Ceramic Capacitors

# High Frequency GQM Series

**HiQ**

Capacitor for high frequency suitable for PA designs.

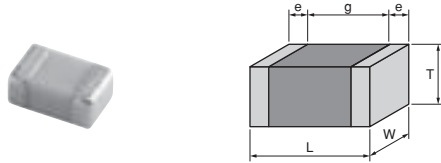

- 1 HiQ and low ESR in UHF and microwave frequency bands.
- 2 Highly conductive copper was adopted for the internal electrodes.
- 3 Product compatible to tight tolerances.
- 4 Achieved high withstand voltages.
- 5 Ideal for improving the characteristics and reducing power consumption in RF equipment.

For General Purpose  
GRW Series

Capacitor Array  
GNM Series

Low ESL  
LLQ Series

High-Q Type  
GJM Series

High Frequency  
GQM Series

Monolithic Microchip  
GMA Series

For Bonding  
GMD Series

Product Information



# GQM Series Temperature Compensating Type HiQ Part Number List

## ■ 1.6x0.8mm

T max.	Rated Voltage	TC Code	Cap.	Tol.	Part Number
0.8mm	250Vdc	C0G	0.1pF	±0.1pF	GQM1875C2ER10BB12#
				±0.25pF	GQM1875C2ER10CB12#
			0.2pF	±0.1pF	GQM1875C2ER20BB12#
				±0.25pF	GQM1875C2ER20CB12#
			0.3pF	±0.1pF	GQM1875C2ER30BB12#
				±0.25pF	GQM1875C2ER30CB12#
			0.4pF	±0.1pF	GQM1875C2ER40BB12#
				±0.25pF	GQM1875C2ER40CB12#
			0.5pF	±0.1pF	GQM1875C2ER50BB12#
				±0.25pF	GQM1875C2ER50CB12#
			0.75pF	±0.1pF	GQM1875C2ER75BB12#
				±0.25pF	GQM1875C2ER75CB12#
			1.0pF	±0.1pF	GQM1875C2E1R0BB12#
				±0.25pF	GQM1875C2E1R0CB12#
			1.1pF	±0.1pF	GQM1875C2E1R1BB12#
				±0.25pF	GQM1875C2E1R1CB12#
			1.2pF	±0.1pF	GQM1875C2E1R2BB12#
				±0.25pF	GQM1875C2E1R2CB12#
			1.3pF	±0.1pF	GQM1875C2E1R3BB12#
				±0.25pF	GQM1875C2E1R3CB12#
			1.5pF	±0.1pF	GQM1875C2E1R5BB12#
				±0.25pF	GQM1875C2E1R5CB12#
			1.6pF	±0.1pF	GQM1875C2E1R6BB12#
				±0.25pF	GQM1875C2E1R6CB12#
			1.8pF	±0.1pF	GQM1875C2E1R8BB12#
				±0.25pF	GQM1875C2E1R8CB12#
			2.0pF	±0.1pF	GQM1875C2E2R0BB12#
				±0.25pF	GQM1875C2E2R0CB12#
			2.2pF	±0.1pF	GQM1875C2E2R2BB12#
				±0.25pF	GQM1875C2E2R2CB12#
			2.4pF	±0.1pF	GQM1875C2E2R4BB12#
				±0.25pF	GQM1875C2E2R4CB12#
			2.7pF	±0.1pF	GQM1875C2E2R7BB12#
				±0.25pF	GQM1875C2E2R7CB12#
			3.0pF	±0.1pF	GQM1875C2E3R0BB12#
				±0.25pF	GQM1875C2E3R0CB12#
			3.3pF	±0.1pF	GQM1875C2E3R3BB12#
				±0.25pF	GQM1875C2E3R3CB12#
			3.6pF	±0.1pF	GQM1875C2E3R6BB12#
				±0.25pF	GQM1875C2E3R6CB12#
			3.9pF	±0.1pF	GQM1875C2E3R9BB12#
				±0.25pF	GQM1875C2E3R9CB12#
			4.0pF	±0.1pF	GQM1875C2E4R0BB12#
				±0.25pF	GQM1875C2E4R0CB12#
			4.3pF	±0.1pF	GQM1875C2E4R3BB12#
				±0.25pF	GQM1875C2E4R3CB12#
			4.7pF	±0.1pF	GQM1875C2E4R7BB12#
				±0.25pF	GQM1875C2E4R7CB12#
5.0pF	±0.1pF	GQM1875C2E5R0BB12#			
	±0.25pF	GQM1875C2E5R0CB12#			
5.1pF	±0.25pF	GQM1875C2E5R1CB12#			
	±0.5pF	GQM1875C2E5R1DB12#			
5.6pF	±0.25pF	GQM1875C2E5R6CB12#			
	±0.5pF	GQM1875C2E5R6DB12#			

T max.	Rated Voltage	TC Code	Cap.	Tol.	Part Number
0.8mm	250Vdc	C0G	6.0pF	±0.25pF	GQM1875C2E6R0CB12#
				±0.5pF	GQM1875C2E6R0DB12#
			6.2pF	±0.25pF	GQM1875C2E6R2CB12#
				±0.5pF	GQM1875C2E6R2DB12#
			6.8pF	±0.25pF	GQM1875C2E6R8CB12#
				±0.5pF	GQM1875C2E6R8DB12#
			7.0pF	±0.25pF	GQM1875C2E7R0CB12#
				±0.5pF	GQM1875C2E7R0DB12#
			7.5pF	±0.25pF	GQM1875C2E7R5CB12#
				±0.5pF	GQM1875C2E7R5DB12#
			8.0pF	±0.25pF	GQM1875C2E8R0CB12#
				±0.5pF	GQM1875C2E8R0DB12#
			8.2pF	±0.25pF	GQM1875C2E8R2CB12#
				±0.5pF	GQM1875C2E8R2DB12#
			9.0pF	±0.25pF	GQM1875C2E9R0CB12#
				±0.5pF	GQM1875C2E9R0DB12#
			9.1pF	±0.25pF	GQM1875C2E9R1CB12#
				±0.5pF	GQM1875C2E9R1DB12#
			10pF	±2%	GQM1875C2E100GB12#
				±5%	GQM1875C2E100JB12#
			11pF	±2%	GQM1875C2E110GB12#
				±5%	GQM1875C2E110JB12#
			12pF	±2%	GQM1875C2E120GB12#
				±5%	GQM1875C2E120JB12#
			13pF	±2%	GQM1875C2E130GB12#
				±5%	GQM1875C2E130JB12#
			15pF	±2%	GQM1875C2E150GB12#
				±5%	GQM1875C2E150JB12#
			16pF	±2%	GQM1875C2E160GB12#
				±5%	GQM1875C2E160JB12#
			18pF	±2%	GQM1875C2E180GB12#
				±5%	GQM1875C2E180JB12#
			20pF	±2%	GQM1875C2E200GB12#
				±5%	GQM1875C2E200JB12#
			22pF	±2%	GQM1875C2E220GB12#
				±5%	GQM1875C2E220JB12#
			24pF	±2%	GQM1875C2E240GB12#
				±5%	GQM1875C2E240JB12#
			27pF	±2%	GQM1875C2E270GB12#
				±5%	GQM1875C2E270JB12#
			30pF	±2%	GQM1875C2E300GB12#
				±5%	GQM1875C2E300JB12#
			33pF	±2%	GQM1875C2E330GB12#
				±5%	GQM1875C2E330JB12#
			36pF	±2%	GQM1875C2E360GB12#
				±5%	GQM1875C2E360JB12#
			39pF	±2%	GQM1875C2E390GB12#
				±5%	GQM1875C2E390JB12#
43pF	±2%	GQM1875C2E430GB12#			
	±5%	GQM1875C2E430JB12#			
47pF	±2%	GQM1875C2E470GB12#			
	±5%	GQM1875C2E470JB12#			
0.9mm	100Vdc	C0G	0.5pF	±0.1pF	GQM1885C2AR50BB01#
				±0.25pF	GQM1885C2AR50CB01#

For General Purpose GRM Series  
 Capacitor Array GNM Series  
 Low ESL LL□ Series  
 High-Q Type GJM Series  
 High Frequency GQM Series  
 Monolithic Microchip GMA Series  
 For Bonding GMD Series  
 Product Information

Part number # indicates the package specification code.

# GQM Series Temperature Compensating Type HiQ Part Number List

(→ ■ 1.6x0.8mm)

T max.	Rated Voltage	TC Code	Cap.	Tol.	Part Number		
0.9mm	100Vdc	C0G	0.75pF	±0.1pF	GQM1885C2AR75BB01#		
				±0.25pF	GQM1885C2AR75CB01#		
			1.0pF	±0.1pF	GQM1885C2A1R0BB01#		
				±0.25pF	GQM1885C2A1R0CB01#		
			1.1pF	±0.1pF	GQM1885C2A1R1BB01#		
				±0.25pF	GQM1885C2A1R1CB01#		
			1.2pF	±0.1pF	GQM1885C2A1R2BB01#		
				±0.25pF	GQM1885C2A1R2CB01#		
			1.3pF	±0.1pF	GQM1885C2A1R3BB01#		
				±0.25pF	GQM1885C2A1R3CB01#		
			1.5pF	±0.1pF	GQM1885C2A1R5BB01#		
				±0.25pF	GQM1885C2A1R5CB01#		
			1.6pF	±0.1pF	GQM1885C2A1R6BB01#		
				±0.25pF	GQM1885C2A1R6CB01#		
			1.8pF	±0.1pF	GQM1885C2A1R8BB01#		
				±0.25pF	GQM1885C2A1R8CB01#		
			2.0pF	±0.1pF	GQM1885C2A2R0BB01#		
				±0.25pF	GQM1885C2A2R0CB01#		
			2.2pF	±0.1pF	GQM1885C2A2R2BB01#		
				±0.25pF	GQM1885C2A2R2CB01#		
			2.4pF	±0.1pF	GQM1885C2A2R4BB01#		
				±0.25pF	GQM1885C2A2R4CB01#		
			2.7pF	±0.1pF	GQM1885C2A2R7BB01#		
				±0.25pF	GQM1885C2A2R7CB01#		
			3.0pF	±0.1pF	GQM1885C2A3R0BB01#		
				±0.25pF	GQM1885C2A3R0CB01#		
			3.3pF	±0.1pF	GQM1885C2A3R3BB01#		
				±0.25pF	GQM1885C2A3R3CB01#		
			3.6pF	±0.1pF	GQM1885C2A3R6BB01#		
				±0.25pF	GQM1885C2A3R6CB01#		
			3.9pF	±0.1pF	GQM1885C2A3R9BB01#		
				±0.25pF	GQM1885C2A3R9CB01#		
			4.0pF	±0.1pF	GQM1885C2A4R0BB01#		
				±0.25pF	GQM1885C2A4R0CB01#		
			4.3pF	±0.1pF	GQM1885C2A4R3BB01#		
				±0.25pF	GQM1885C2A4R3CB01#		
			4.7pF	±0.1pF	GQM1885C2A4R7BB01#		
				±0.25pF	GQM1885C2A4R7CB01#		
			5.0pF	±0.1pF	GQM1885C2A5R0BB01#		
				±0.25pF	GQM1885C2A5R0CB01#		
			5.1pF	±0.25pF	GQM1885C2A5R1CB01#		
				±0.5pF	GQM1885C2A5R1DB01#		
			5.6pF	±0.25pF	GQM1885C2A5R6CB01#		
				±0.5pF	GQM1885C2A5R6DB01#		
			6.0pF	±0.25pF	GQM1885C2A6R0CB01#		
				±0.5pF	GQM1885C2A6R0DB01#		
			6.2pF	±0.25pF	GQM1885C2A6R2CB01#		
				±0.5pF	GQM1885C2A6R2DB01#		
			6.8pF	±0.25pF	GQM1885C2A6R8CB01#		
				±0.5pF	GQM1885C2A6R8DB01#		
			CK	0.5pF	±0.1pF	GQM1884C2AR50BB01#	
					±0.25pF	GQM1884C2AR50CB01#	
					0.75pF	±0.1pF	GQM1884C2AR75BB01#
						±0.25pF	GQM1884C2AR75CB01#

T max.	Rated Voltage	TC Code	Cap.	Tol.	Part Number	
0.9mm	100Vdc	CK	1.0pF	±0.1pF	GQM1884C2A1R0BB01#	
				±0.25pF	GQM1884C2A1R0CB01#	
			1.1pF	±0.1pF	GQM1884C2A1R1BB01#	
				±0.25pF	GQM1884C2A1R1CB01#	
			1.2pF	±0.1pF	GQM1884C2A1R2BB01#	
				±0.25pF	GQM1884C2A1R2CB01#	
			1.3pF	±0.1pF	GQM1884C2A1R3BB01#	
				±0.25pF	GQM1884C2A1R3CB01#	
			1.5pF	±0.1pF	GQM1884C2A1R5BB01#	
				±0.25pF	GQM1884C2A1R5CB01#	
			1.6pF	±0.1pF	GQM1884C2A1R6BB01#	
				±0.25pF	GQM1884C2A1R6CB01#	
			1.8pF	±0.1pF	GQM1884C2A1R8BB01#	
				±0.25pF	GQM1884C2A1R8CB01#	
			2.0pF	±0.1pF	GQM1884C2A2R0BB01#	
				±0.25pF	GQM1884C2A2R0CB01#	
			CJ	2.2pF	±0.1pF	GQM1883C2A2R2BB01#
					±0.25pF	GQM1883C2A2R2CB01#
			2.4pF	±0.1pF	GQM1883C2A2R4BB01#	
				±0.25pF	GQM1883C2A2R4CB01#	
			2.7pF	±0.1pF	GQM1883C2A2R7BB01#	
				±0.25pF	GQM1883C2A2R7CB01#	
			3.0pF	±0.1pF	GQM1883C2A3R0BB01#	
				±0.25pF	GQM1883C2A3R0CB01#	
			3.3pF	±0.1pF	GQM1883C2A3R3BB01#	
				±0.25pF	GQM1883C2A3R3CB01#	
			3.6pF	±0.1pF	GQM1883C2A3R6BB01#	
				±0.25pF	GQM1883C2A3R6CB01#	
			3.9pF	±0.1pF	GQM1883C2A3R9BB01#	
				±0.25pF	GQM1883C2A3R9CB01#	
			CH	4.0pF	±0.1pF	GQM1882C2A4R0BB01#
					±0.25pF	GQM1882C2A4R0CB01#
			4.3pF	±0.1pF	GQM1882C2A4R3BB01#	
				±0.25pF	GQM1882C2A4R3CB01#	
			4.7pF	±0.1pF	GQM1882C2A4R7BB01#	
				±0.25pF	GQM1882C2A4R7CB01#	
		5.0pF	±0.1pF	GQM1882C2A5R0BB01#		
			±0.25pF	GQM1882C2A5R0CB01#		
		5.1pF	±0.25pF	GQM1882C2A5R1CB01#		
			±0.5pF	GQM1882C2A5R1DB01#		
		5.6pF	±0.25pF	GQM1882C2A5R6CB01#		
			±0.5pF	GQM1882C2A5R6DB01#		
		6.0pF	±0.25pF	GQM1882C2A6R0CB01#		
			±0.5pF	GQM1882C2A6R0DB01#		
		6.2pF	±0.25pF	GQM1882C2A6R2CB01#		
			±0.5pF	GQM1882C2A6R2DB01#		
		6.8pF	±0.25pF	GQM1882C2A6R8CB01#		
			±0.5pF	GQM1882C2A6R8DB01#		
		50Vdc	C0G	7.0pF	±0.25pF	GQM1885C1H7R0CB01#
					±0.5pF	GQM1885C1H7R0DB01#
				7.5pF	±0.25pF	GQM1885C1H7R5CB01#
					±0.5pF	GQM1885C1H7R5DB01#
		8.0pF	±0.25pF	GQM1885C1H8R0CB01#		
			±0.5pF	GQM1885C1H8R0DB01#		

Part number # indicates the package specification code.

For General Purpose GRM Series

Capacitor Array GNM Series

Low ESL LL Series

High-Q Type GJM Series

High Frequency GQM Series

Monolithic Microchip GMA Series

For Bonding GMD Series

Product Information

# GQM Series Temperature Compensating Type HiQ Part Number List

(→ ■ 1.6x0.8mm)

T max.	Rated Voltage	TC Code	Cap.	Tol.	Part Number
0.9mm	50Vdc	C0G	8.2pF	±0.25pF	GQM1885C1H8R2CB01#
				±0.5pF	GQM1885C1H8R2DB01#
			9.0pF	±0.25pF	GQM1885C1H9R0CB01#
				±0.5pF	GQM1885C1H9R0DB01#
			9.1pF	±0.25pF	GQM1885C1H9R1CB01#
				±0.5pF	GQM1885C1H9R1DB01#
			10pF	±2%	GQM1885C1H100GB01#
				±5%	GQM1885C1H100JB01#
			11pF	±2%	GQM1885C1H110GB01#
				±5%	GQM1885C1H110JB01#
			12pF	±2%	GQM1885C1H120GB01#
				±5%	GQM1885C1H120JB01#
			13pF	±2%	GQM1885C1H130GB01#
				±5%	GQM1885C1H130JB01#
			15pF	±2%	GQM1885C1H150GB01#
				±5%	GQM1885C1H150JB01#
			16pF	±2%	GQM1885C1H160GB01#
				±5%	GQM1885C1H160JB01#
			18pF	±2%	GQM1885C1H180GB01#
				±5%	GQM1885C1H180JB01#
			20pF	±2%	GQM1885C1H200GB01#
				±5%	GQM1885C1H200JB01#
			22pF	±2%	GQM1885C1H220GB01#
				±5%	GQM1885C1H220JB01#
			24pF	±2%	GQM1885C1H240GB01#
				±5%	GQM1885C1H240JB01#
			27pF	±2%	GQM1885C1H270GB01#
				±5%	GQM1885C1H270JB01#
			30pF	±2%	GQM1885C1H300GB01#
				±5%	GQM1885C1H300JB01#
			33pF	±2%	GQM1885C1H330GB01#
				±5%	GQM1885C1H330JB01#
			36pF	±2%	GQM1885C1H360GB01#
				±5%	GQM1885C1H360JB01#
			39pF	±2%	GQM1885C1H390GB01#
				±5%	GQM1885C1H390JB01#
			43pF	±2%	GQM1885C1H430GB01#
				±5%	GQM1885C1H430JB01#
			47pF	±2%	GQM1885C1H470GB01#
				±5%	GQM1885C1H470JB01#
			51pF	±2%	GQM1885C1H510GB01#
				±5%	GQM1885C1H510JB01#
			56pF	±2%	GQM1885C1H560GB01#
				±5%	GQM1885C1H560JB01#
			62pF	±2%	GQM1885C1H620GB01#
				±5%	GQM1885C1H620JB01#
			68pF	±2%	GQM1885C1H680GB01#
				±5%	GQM1885C1H680JB01#
75pF	±2%	GQM1885C1H750GB01#			
	±5%	GQM1885C1H750JB01#			
82pF	±2%	GQM1885C1H820GB01#			
	±5%	GQM1885C1H820JB01#			
91pF	±2%	GQM1885C1H910GB01#			
	±5%	GQM1885C1H910JB01#			

T max.	Rated Voltage	TC Code	Cap.	Tol.	Part Number
0.9mm	50Vdc	C0G	100pF	±2%	GQM1885C1H101GB01#
				±5%	GQM1885C1H101JB01#
		CH	7.0pF	±0.25pF	GQM1882C1H7R0CB01#
				±0.5pF	GQM1882C1H7R0DB01#
		7.5pF	±0.25pF	GQM1882C1H7R5CB01#	
			±0.5pF	GQM1882C1H7R5DB01#	
		8.0pF	±0.25pF	GQM1882C1H8R0CB01#	
			±0.5pF	GQM1882C1H8R0DB01#	
		8.2pF	±0.25pF	GQM1882C1H8R2CB01#	
			±0.5pF	GQM1882C1H8R2DB01#	
		9.0pF	±0.25pF	GQM1882C1H9R0CB01#	
			±0.5pF	GQM1882C1H9R0DB01#	
		9.1pF	±0.25pF	GQM1882C1H9R1CB01#	
			±0.5pF	GQM1882C1H9R1DB01#	
		10pF	±2%	GQM1882C1H100GB01#	
			±5%	GQM1882C1H100JB01#	
		11pF	±2%	GQM1882C1H110GB01#	
			±5%	GQM1882C1H110JB01#	
		12pF	±2%	GQM1882C1H120GB01#	
			±5%	GQM1882C1H120JB01#	
		13pF	±2%	GQM1882C1H130GB01#	
			±5%	GQM1882C1H130JB01#	
		15pF	±2%	GQM1882C1H150GB01#	
			±5%	GQM1882C1H150JB01#	
		16pF	±2%	GQM1882C1H160GB01#	
			±5%	GQM1882C1H160JB01#	
		18pF	±2%	GQM1882C1H180GB01#	
			±5%	GQM1882C1H180JB01#	
		20pF	±2%	GQM1882C1H200GB01#	
			±5%	GQM1882C1H200JB01#	
		22pF	±2%	GQM1882C1H220GB01#	
			±5%	GQM1882C1H220JB01#	
		24pF	±2%	GQM1882C1H240GB01#	
			±5%	GQM1882C1H240JB01#	
		27pF	±2%	GQM1882C1H270GB01#	
			±5%	GQM1882C1H270JB01#	
		30pF	±2%	GQM1882C1H300GB01#	
			±5%	GQM1882C1H300JB01#	
		33pF	±2%	GQM1882C1H330GB01#	
			±5%	GQM1882C1H330JB01#	
		36pF	±2%	GQM1882C1H360GB01#	
			±5%	GQM1882C1H360JB01#	
		39pF	±2%	GQM1882C1H390GB01#	
			±5%	GQM1882C1H390JB01#	
		43pF	±2%	GQM1882C1H430GB01#	
			±5%	GQM1882C1H430JB01#	
		47pF	±2%	GQM1882C1H470GB01#	
			±5%	GQM1882C1H470JB01#	
51pF	±2%	GQM1882C1H510GB01#			
	±5%	GQM1882C1H510JB01#			
56pF	±2%	GQM1882C1H560GB01#			
	±5%	GQM1882C1H560JB01#			
62pF	±2%	GQM1882C1H620GB01#			
	±5%	GQM1882C1H620JB01#			
68pF	±2%	GQM1882C1H680GB01#			
	±5%	GQM1882C1H680JB01#			
75pF	±2%	GQM1882C1H750GB01#			
	±5%	GQM1882C1H750JB01#			
82pF	±2%	GQM1882C1H820GB01#			
	±5%	GQM1882C1H820JB01#			
91pF	±2%	GQM1882C1H910GB01#			
	±5%	GQM1882C1H910JB01#			

For General Purpose GRM Series

Capacitor Array GNM Series

Low ESL LLQ Series

High-Q Type GJM Series

High Frequency GQM Series

Monolithic Microchip GMA Series

For Bonding GMD Series

Product Information

Part number # indicates the package specification code.

# GQM Series Temperature Compensating Type HiQ Part Number List

(→ ■ 1.6x0.8mm)

T max.	Rated Voltage	TC Code	Cap.	Tol.	Part Number
0.9mm	50Vdc	CH	68pF	±2%	GQM1882C1H680GB01#
				±5%	GQM1882C1H680JB01#
			75pF	±2%	GQM1882C1H750GB01#
				±5%	GQM1882C1H750JB01#
			82pF	±2%	GQM1882C1H820GB01#
				±5%	GQM1882C1H820JB01#
			91pF	±2%	GQM1882C1H910GB01#
				±5%	GQM1882C1H910JB01#
			100pF	±2%	GQM1882C1H101GB01#
				±5%	GQM1882C1H101JB01#

T max.	Rated Voltage	TC Code	Cap.	Tol.	Part Number
0.95mm	100Vdc	C0G	4.7pF	±0.25pF	GQM2195C2A4R7CB01#
				±0.1pF	GQM2195C2A5R0BB01#
			5.0pF	±0.25pF	GQM2195C2A5R0CB01#
				±0.1pF	GQM2195C2A5R1CB01#
			5.1pF	±0.25pF	GQM2195C2A5R1DB01#
				±0.5pF	GQM2195C2A5R6CB01#
			5.6pF	±0.25pF	GQM2195C2A5R6DB01#
				±0.5pF	GQM2195C2A6R0CB01#
			6.0pF	±0.25pF	GQM2195C2A6R0DB01#
				±0.5pF	GQM2195C2A6R2CB01#
			6.2pF	±0.25pF	GQM2195C2A6R2DB01#
				±0.5pF	GQM2195C2A6R8CB01#
			6.8pF	±0.25pF	GQM2195C2A6R8DB01#
				±0.5pF	GQM2195C2A7R0CB01#
			7.0pF	±0.25pF	GQM2195C2A7R0DB01#
				±0.5pF	GQM2195C2A7R5CB01#
			7.5pF	±0.25pF	GQM2195C2A7R5DB01#
				±0.5pF	GQM2195C2A8R0CB01#
			8.0pF	±0.25pF	GQM2195C2A8R0DB01#
				±0.5pF	GQM2195C2A8R2CB01#
			8.2pF	±0.25pF	GQM2195C2A8R2DB01#
				±0.5pF	GQM2195C2A9R0CB01#
			9.0pF	±0.25pF	GQM2195C2A9R0DB01#
				±0.5pF	GQM2195C2A9R1CB01#
			9.1pF	±0.25pF	GQM2195C2A9R1DB01#
				±0.5pF	GQM2195C2A100GB01#
			10pF	±2%	GQM2195C2A100JB01#
				±5%	GQM2195C2A110GB01#
			11pF	±2%	GQM2195C2A110JB01#
				±5%	GQM2195C2A120GB01#
			12pF	±2%	GQM2195C2A120JB01#
				±5%	GQM2195C2A130GB01#
			13pF	±2%	GQM2195C2A130JB01#
				±5%	GQM2195C2A150GB01#
			15pF	±2%	GQM2195C2A150JB01#
				±5%	GQM2195C2A160GB01#
			16pF	±2%	GQM2195C2A160JB01#
				±5%	GQM2195C2A180GB01#
			18pF	±2%	GQM2195C2A180JB01#
				±5%	GQM2194C2AR50BB01#
			0.5pF	±0.1pF	GQM2194C2AR50CB01#
				±0.25pF	GQM2194C2AR75BB01#
			0.75pF	±0.1pF	GQM2194C2AR75CB01#
				±0.25pF	GQM2194C2A1R0BB01#
			1.0pF	±0.1pF	GQM2194C2A1R0CB01#
				±0.25pF	GQM2194C2A1R1BB01#
			1.1pF	±0.1pF	GQM2194C2A1R1CB01#
				±0.25pF	GQM2194C2A1R2BB01#
1.2pF	±0.1pF	GQM2194C2A1R2CB01#			
	±0.25pF	GQM2194C2A1R3BB01#			
1.3pF	±0.1pF	GQM2194C2A1R3CB01#			
	±0.25pF	GQM2194C2A1R5BB01#			
1.5pF	±0.1pF	GQM2194C2A1R5CB01#			
	±0.25pF	GQM2194C2A1R6BB01#			
1.6pF	±0.1pF	GQM2194C2A1R6CB01#			
	±0.25pF	GQM2194C2A1R8BB01#			
1.8pF	±0.1pF	GQM2194C2A1R8CB01#			
	±0.25pF	GQM2194C2A2R0BB01#			
2.0pF	±0.1pF	GQM2194C2A2R0CB01#			
	±0.25pF	GQM2194C2A2R2BB01#			
2.2pF	±0.1pF	GQM2194C2A2R2CB01#			
	±0.25pF	GQM2194C2A2R4BB01#			
2.4pF	±0.1pF	GQM2194C2A2R4CB01#			
	±0.25pF	GQM2194C2A2R7BB01#			
2.7pF	±0.1pF	GQM2194C2A2R7CB01#			
	±0.25pF	GQM2194C2A3R0BB01#			
3.0pF	±0.1pF	GQM2194C2A3R0CB01#			
	±0.25pF	GQM2194C2A3R3BB01#			
3.3pF	±0.1pF	GQM2194C2A3R3CB01#			
	±0.25pF	GQM2194C2A3R6BB01#			
3.6pF	±0.1pF	GQM2194C2A3R6CB01#			
	±0.25pF	GQM2194C2A3R9BB01#			
3.9pF	±0.1pF	GQM2194C2A3R9CB01#			
	±0.25pF	GQM2194C2A4R0BB01#			
4.0pF	±0.1pF	GQM2194C2A4R0CB01#			
	±0.25pF	GQM2194C2A4R3BB01#			
4.3pF	±0.1pF	GQM2194C2A4R3CB01#			
	±0.25pF	GQM2194C2A4R7BB01#			
4.7pF	±0.1pF	GQM2194C2A1R6BB01#			

■ 2.0x1.25mm

T max.	Rated Voltage	TC Code	Cap.	Tol.	Part Number
0.95mm	100Vdc	C0G	0.5pF	±0.1pF	GQM2195C2AR50BB01#
				±0.25pF	GQM2195C2AR50CB01#
			0.75pF	±0.1pF	GQM2195C2AR75BB01#
				±0.25pF	GQM2195C2AR75CB01#
			1.0pF	±0.1pF	GQM2195C2A1R0BB01#
				±0.25pF	GQM2195C2A1R0CB01#
			1.1pF	±0.1pF	GQM2195C2A1R1BB01#
				±0.25pF	GQM2195C2A1R1CB01#
			1.2pF	±0.1pF	GQM2195C2A1R2BB01#
				±0.25pF	GQM2195C2A1R2CB01#
			1.3pF	±0.1pF	GQM2195C2A1R3BB01#
				±0.25pF	GQM2195C2A1R3CB01#
			1.5pF	±0.1pF	GQM2195C2A1R5BB01#
				±0.25pF	GQM2195C2A1R5CB01#
			1.6pF	±0.1pF	GQM2195C2A1R6BB01#
				±0.25pF	GQM2195C2A1R6CB01#
			1.8pF	±0.1pF	GQM2195C2A1R8BB01#
				±0.25pF	GQM2195C2A1R8CB01#
			2.0pF	±0.1pF	GQM2195C2A2R0BB01#
				±0.25pF	GQM2195C2A2R0CB01#
			2.2pF	±0.1pF	GQM2195C2A2R2BB01#
				±0.25pF	GQM2195C2A2R2CB01#
			2.4pF	±0.1pF	GQM2195C2A2R4BB01#
				±0.25pF	GQM2195C2A2R4CB01#
			2.7pF	±0.1pF	GQM2195C2A2R7BB01#
				±0.25pF	GQM2195C2A2R7CB01#
			3.0pF	±0.1pF	GQM2195C2A3R0BB01#
				±0.25pF	GQM2195C2A3R0CB01#
			3.3pF	±0.1pF	GQM2195C2A3R3BB01#
				±0.25pF	GQM2195C2A3R3CB01#
			3.6pF	±0.1pF	GQM2195C2A3R6BB01#
				±0.25pF	GQM2195C2A3R6CB01#
			3.9pF	±0.1pF	GQM2195C2A3R9BB01#
				±0.25pF	GQM2195C2A3R9CB01#
			4.0pF	±0.1pF	GQM2195C2A4R0BB01#
				±0.25pF	GQM2195C2A4R0CB01#
			4.3pF	±0.1pF	GQM2195C2A4R3BB01#
				±0.25pF	GQM2195C2A4R3CB01#
			4.7pF	±0.1pF	GQM2195C2A4R7BB01#

Part number # indicates the package specification code.

For General Purpose GRM Series

Capacitor Array GNM Series

Low ESL LLI Series

High-Q Type GJM Series

High Frequency GQM Series

Monolithic Microchip GMA Series

For Bonding GMD Series

Product Information



# GQM Series Temperature Compensating Type HiQ Part Number List

(→ ■ 2.0x1.25mm)

T max.	Rated Voltage	TC Code	Cap.	Tol.	Part Number	
0.95mm	100Vdc	CK	1.6pF	±0.25pF	GQM2194C2A1R6CB01#	
				±0.1pF	GQM2194C2A1R8BB01#	
			1.8pF	±0.25pF	GQM2194C2A1R8CB01#	
				±0.1pF	GQM2194C2A2R0BB01#	
			2.0pF	±0.25pF	GQM2194C2A2R0CB01#	
				CJ	2.2pF	±0.1pF
			±0.25pF			GQM2193C2A2R2CB01#
			2.4pF		±0.1pF	GQM2193C2A2R4BB01#
					±0.25pF	GQM2193C2A2R4CB01#
			2.7pF		±0.1pF	GQM2193C2A2R7BB01#
		±0.25pF			GQM2193C2A2R7CB01#	
		3.0pF	±0.1pF		GQM2193C2A3R0BB01#	
			±0.25pF		GQM2193C2A3R0CB01#	
		3.3pF	±0.1pF		GQM2193C2A3R3BB01#	
			±0.25pF		GQM2193C2A3R3CB01#	
		3.6pF	±0.1pF	GQM2193C2A3R6BB01#		
			±0.25pF	GQM2193C2A3R6CB01#		
		3.9pF	±0.1pF	GQM2193C2A3R9BB01#		
			±0.25pF	GQM2193C2A3R9CB01#		
		CH	4.0pF	±0.1pF	GQM2192C2A4R0BB01#	
				±0.25pF	GQM2192C2A4R0CB01#	
			4.3pF	±0.1pF	GQM2192C2A4R3BB01#	
				±0.25pF	GQM2192C2A4R3CB01#	
			4.7pF	±0.1pF	GQM2192C2A4R7BB01#	
				±0.25pF	GQM2192C2A4R7CB01#	
			5.0pF	±0.1pF	GQM2192C2A5R0BB01#	
				±0.25pF	GQM2192C2A5R0CB01#	
			5.1pF	±0.25pF	GQM2192C2A5R1CB01#	
				±0.5pF	GQM2192C2A5R1DB01#	
			5.6pF	±0.25pF	GQM2192C2A5R6CB01#	
				±0.5pF	GQM2192C2A5R6DB01#	
			6.0pF	±0.25pF	GQM2192C2A6R0CB01#	
				±0.5pF	GQM2192C2A6R0DB01#	
			6.2pF	±0.25pF	GQM2192C2A6R2CB01#	
				±0.5pF	GQM2192C2A6R2DB01#	
			6.8pF	±0.25pF	GQM2192C2A6R8CB01#	
				±0.5pF	GQM2192C2A6R8DB01#	
			7.0pF	±0.25pF	GQM2192C2A7R0CB01#	
				±0.5pF	GQM2192C2A7R0DB01#	
			7.5pF	±0.25pF	GQM2192C2A7R5CB01#	
				±0.5pF	GQM2192C2A7R5DB01#	
			8.0pF	±0.25pF	GQM2192C2A8R0CB01#	
				±0.5pF	GQM2192C2A8R0DB01#	
			8.2pF	±0.25pF	GQM2192C2A8R2CB01#	
				±0.5pF	GQM2192C2A8R2DB01#	
			9.0pF	±0.25pF	GQM2192C2A9R0CB01#	
				±0.5pF	GQM2192C2A9R0DB01#	
			9.1pF	±0.25pF	GQM2192C2A9R1CB01#	
				±0.5pF	GQM2192C2A9R1DB01#	
		10pF	±2%	GQM2192C2A100GB01#		
			±5%	GQM2192C2A100JB01#		
		11pF	±2%	GQM2192C2A110GB01#		
			±5%	GQM2192C2A110JB01#		
		12pF	±2%	GQM2192C2A120GB01#		

T max.	Rated Voltage	TC Code	Cap.	Tol.	Part Number		
0.95mm	100Vdc	CH	12pF	±5%	GQM2192C2A120JB01#		
				±2%	GQM2192C2A130GB01#		
			13pF	±5%	GQM2192C2A130JB01#		
				±2%	GQM2192C2A150GB01#		
			15pF	±5%	GQM2192C2A150JB01#		
				±2%	GQM2192C2A160GB01#		
			16pF	±5%	GQM2192C2A160JB01#		
				±2%	GQM2192C2A180GB01#		
			18pF	±5%	GQM2192C2A180JB01#		
				50Vdc	C0G	20pF	±2%
			±5%				GQM2195C1H200JB01#
			22pF			±2%	GQM2195C1H220GB01#
						±5%	GQM2195C1H220JB01#
			24pF			±2%	GQM2195C1H240GB01#
						±5%	GQM2195C1H240JB01#
			27pF			±2%	GQM2195C1H270GB01#
						±5%	GQM2195C1H270JB01#
			30pF			±2%	GQM2195C1H300GB01#
		±5%				GQM2195C1H300JB01#	
		33pF	±2%			GQM2195C1H330GB01#	
			±5%			GQM2195C1H330JB01#	
		36pF	±2%	GQM2195C1H360GB01#			
			±5%	GQM2195C1H360JB01#			
		39pF	±2%	GQM2195C1H390GB01#			
			±5%	GQM2195C1H390JB01#			
		43pF	±2%	GQM2195C1H430GB01#			
			±5%	GQM2195C1H430JB01#			
		47pF	±2%	GQM2195C1H470GB01#			
			±5%	GQM2195C1H470JB01#			
		51pF	±2%	GQM2195C1H510GB01#			
±5%	GQM2195C1H510JB01#						
56pF	±2%	GQM2195C1H560GB01#					
	±5%	GQM2195C1H560JB01#					
62pF	±2%	GQM2195C1H620GB01#					
	±5%	GQM2195C1H620JB01#					
68pF	±2%	GQM2195C1H680GB01#					
	±5%	GQM2195C1H680JB01#					
75pF	±2%	GQM2195C1H750GB01#					
	±5%	GQM2195C1H750JB01#					
82pF	±2%	GQM2195C1H820GB01#					
	±5%	GQM2195C1H820JB01#					
91pF	±2%	GQM2195C1H910GB01#					
	±5%	GQM2195C1H910JB01#					
100pF	±2%	GQM2195C1H101GB01#					
	±5%	GQM2195C1H101JB01#					
CH	CH	20pF	±2%	GQM2192C1H200GB01#			
			±5%	GQM2192C1H200JB01#			
		22pF	±2%	GQM2192C1H220GB01#			
			±5%	GQM2192C1H220JB01#			
		24pF	±2%	GQM2192C1H240GB01#			
			±5%	GQM2192C1H240JB01#			
27pF	±2%	GQM2192C1H270GB01#					
	±5%	GQM2192C1H270JB01#					
30pF	±2%	GQM2192C1H300GB01#					

For General Purpose GRM Series  
 Capacitor Array GNM Series  
 Low ESL LLL Series  
 High-Q Type GJM Series  
 High Frequency GQM Series  
 Monolithic Microchip GMA Series  
 For Bonding GMD Series  
 Product Information

Part number # indicates the package specification code.



## GQM Series Temperature Compensating Type HiQ Part Number List

(→ ■ 2.0x1.25mm)

T max.	Rated Voltage	TC Code	Cap.	Tol.	Part Number			
0.95mm	50Vdc	CH	30pF	±5%	GQM2192C1H300JB01#			
				±2%	GQM2192C1H330GB01#			
			33pF	±5%	GQM2192C1H330JB01#			
				±2%	GQM2192C1H360GB01#			
			36pF	±5%	GQM2192C1H360JB01#			
				±2%	GQM2192C1H390GB01#			
			39pF	±5%	GQM2192C1H390JB01#			
				±2%	GQM2192C1H430GB01#			
			43pF	±5%	GQM2192C1H430JB01#			
				±2%	GQM2192C1H470GB01#			
			47pF	±5%	GQM2192C1H470JB01#			
				±2%	GQM2192C1H510GB01#			
			51pF	±5%	GQM2192C1H510JB01#			
				±2%	GQM2192C1H560GB01#			
			56pF	±5%	GQM2192C1H560JB01#			
				±2%	GQM2192C1H620GB01#			
			62pF	±5%	GQM2192C1H620JB01#			
				±2%	GQM2192C1H680GB01#			
			68pF	±5%	GQM2192C1H680JB01#			
				±2%	GQM2192C1H750GB01#			
			75pF	±5%	GQM2192C1H750JB01#			
				±2%	GQM2192C1H820GB01#			
			82pF	±5%	GQM2192C1H820JB01#			
				±2%	GQM2192C1H910GB01#			
			91pF	±5%	GQM2192C1H910JB01#			
				±2%	GQM2192C1H101GB01#			
			100pF	±5%	GQM2192C1H101JB01#			
				1mm	250Vdc	C0G	0.5pF	±0.1pF
			±0.25pF					GQM2195C2ER50CB12#
			0.75pF				±0.1pF	GQM2195C2ER75BB12#
							±0.25pF	GQM2195C2ER75CB12#
			1.0pF				±0.1pF	GQM2195C2E1R0BB12#
							±0.25pF	GQM2195C2E1R0CB12#
			1.1pF				±0.1pF	GQM2195C2E1R1BB12#
							±0.25pF	GQM2195C2E1R1CB12#
			1.2pF				±0.1pF	GQM2195C2E1R2BB12#
±0.25pF	GQM2195C2E1R2CB12#							
1.3pF	±0.1pF	GQM2195C2E1R3BB12#						
	±0.25pF	GQM2195C2E1R3CB12#						
1.5pF	±0.1pF	GQM2195C2E1R5BB12#						
	±0.25pF	GQM2195C2E1R5CB12#						
1.6pF	±0.1pF	GQM2195C2E1R6BB12#						
	±0.25pF	GQM2195C2E1R6CB12#						
1.8pF	±0.1pF	GQM2195C2E1R8BB12#						
	±0.25pF	GQM2195C2E1R8CB12#						
2.0pF	±0.1pF	GQM2195C2E2R0BB12#						
	±0.25pF	GQM2195C2E2R0CB12#						
2.2pF	±0.1pF	GQM2195C2E2R2BB12#						
	±0.25pF	GQM2195C2E2R2CB12#						
2.4pF	±0.1pF	GQM2195C2E2R4BB12#						
	±0.25pF	GQM2195C2E2R4CB12#						
2.7pF	±0.1pF	GQM2195C2E2R7BB12#						
	±0.25pF	GQM2195C2E2R7CB12#						
3.0pF	±0.1pF	GQM2195C2E3R0BB12#						

T max.	Rated Voltage	TC Code	Cap.	Tol.	Part Number
1mm	250Vdc	C0G	3.0pF	±0.25pF	GQM2195C2E3R0CB12#
				±0.1pF	GQM2195C2E3R3BB12#
			3.3pF	±0.25pF	GQM2195C2E3R3CB12#
				±0.1pF	GQM2195C2E3R6BB12#
			3.6pF	±0.25pF	GQM2195C2E3R6CB12#
				±0.1pF	GQM2195C2E3R9BB12#
			3.9pF	±0.25pF	GQM2195C2E3R9CB12#
				±0.1pF	GQM2195C2E4R0BB12#
			4.0pF	±0.25pF	GQM2195C2E4R0CB12#
				±0.1pF	GQM2195C2E4R3BB12#
			4.3pF	±0.25pF	GQM2195C2E4R3CB12#
				±0.1pF	GQM2195C2E4R7BB12#
			4.7pF	±0.25pF	GQM2195C2E4R7CB12#
				±0.1pF	GQM2195C2E5R0BB12#
			5.0pF	±0.25pF	GQM2195C2E5R0CB12#
				±0.1pF	GQM2195C2E5R1CB12#
			5.1pF	±0.5pF	GQM2195C2E5R1DB12#
				±0.25pF	GQM2195C2E5R6CB12#
			5.6pF	±0.5pF	GQM2195C2E5R6DB12#
				±0.25pF	GQM2195C2E6R0CB12#
			6.0pF	±0.5pF	GQM2195C2E6R0DB12#
				±0.25pF	GQM2195C2E6R2CB12#
			6.2pF	±0.5pF	GQM2195C2E6R2DB12#
				±0.25pF	GQM2195C2E6R8CB12#
			6.8pF	±0.5pF	GQM2195C2E6R8DB12#
				±0.25pF	GQM2195C2E7R0CB12#
			7.0pF	±0.5pF	GQM2195C2E7R0DB12#
				±0.25pF	GQM2195C2E7R5CB12#
			7.5pF	±0.5pF	GQM2195C2E7R5DB12#
				±0.25pF	GQM2195C2E8R0CB12#
			8.0pF	±0.5pF	GQM2195C2E8R0DB12#
				±0.25pF	GQM2195C2E8R2CB12#
			8.2pF	±0.5pF	GQM2195C2E8R2DB12#
				±0.25pF	GQM2195C2E9R0CB12#
			9.0pF	±0.5pF	GQM2195C2E9R0DB12#
				±0.25pF	GQM2195C2E9R1CB12#
9.1pF	±0.5pF	GQM2195C2E9R1DB12#			
	±2%	GQM2195C2E100GB12#			
10pF	±5%	GQM2195C2E100JB12#			
	±2%	GQM2195C2E110GB12#			
11pF	±5%	GQM2195C2E110JB12#			
	±2%	GQM2195C2E120GB12#			
12pF	±5%	GQM2195C2E120JB12#			
	±2%	GQM2195C2E130GB12#			
13pF	±5%	GQM2195C2E130JB12#			
	±2%	GQM2195C2E150GB12#			
15pF	±5%	GQM2195C2E150JB12#			
	±2%	GQM2195C2E160GB12#			
16pF	±5%	GQM2195C2E160JB12#			
	±2%	GQM2195C2E180GB12#			
18pF	±5%	GQM2195C2E180JB12#			
	±2%	GQM2195C2E200GB12#			
20pF	±5%	GQM2195C2E200JB12#			
	±2%	GQM2195C2E220GB12#			

Part number # indicates the package specification code.

# GQM Series Temperature Compensating Type HiQ Part Number List

(→ ■ 2.0x1.25mm)

T max.	Rated Voltage	TC Code	Cap.	Tol.	Part Number
1mm	250Vdc	C0G	22pF	±5%	GQM2195C2E220JB12#
				±2%	GQM2195C2E240GB12#
			24pF	±5%	GQM2195C2E240JB12#
				±2%	GQM2195C2E270GB12#
			27pF	±5%	GQM2195C2E270JB12#
				±2%	GQM2195C2E300GB12#
			30pF	±5%	GQM2195C2E300JB12#
				±2%	GQM2195C2E330GB12#
			33pF	±5%	GQM2195C2E330JB12#
				±2%	GQM2195C2E360GB12#
			36pF	±5%	GQM2195C2E360JB12#
				±2%	GQM2195C2E390GB12#
			39pF	±5%	GQM2195C2E390JB12#
				±2%	GQM2195C2E430GB12#
			43pF	±5%	GQM2195C2E430JB12#
				±2%	GQM2195C2E470GB12#
			47pF	±5%	GQM2195C2E470JB12#
				±2%	GQM2195C2E510GB12#
			51pF	±5%	GQM2195C2E510JB12#
				±2%	GQM2195C2E560GB12#
			56pF	±5%	GQM2195C2E560JB12#
				±2%	GQM2195C2E620GB12#
			62pF	±5%	GQM2195C2E620JB12#
				±2%	GQM2195C2E680GB12#
			68pF	±5%	GQM2195C2E680JB12#
				±2%	GQM2195C2E750GB12#
			75pF	±5%	GQM2195C2E750JB12#
				±2%	GQM2195C2E820GB12#
			82pF	±5%	GQM2195C2E820JB12#
				±2%	GQM2195C2E910GB12#
91pF	±5%	GQM2195C2E910JB12#			
	±2%	GQM2195C2E101GB12#			
100pF	±5%	GQM2195C2E101JB12#			

■ 2.8x2.8mm

T max.	Rated Voltage	TC Code	Cap.	Tol.	Part Number
1.35mm	500Vdc	C0G	0.5pF	±0.1pF	GQM22M5C2HR50BB01#
				±0.25pF	GQM22M5C2HR50CB01#
			0.75pF	±0.1pF	GQM22M5C2HR75BB01#
				±0.25pF	GQM22M5C2HR75CB01#
			1.0pF	±0.1pF	GQM22M5C2H1R0BB01#
				±0.25pF	GQM22M5C2H1R0CB01#
			1.1pF	±0.1pF	GQM22M5C2H1R1BB01#
				±0.25pF	GQM22M5C2H1R1CB01#
			1.2pF	±0.1pF	GQM22M5C2H1R2BB01#
				±0.25pF	GQM22M5C2H1R2CB01#
			1.3pF	±0.1pF	GQM22M5C2H1R3BB01#
				±0.25pF	GQM22M5C2H1R3CB01#
			1.5pF	±0.1pF	GQM22M5C2H1R5BB01#
				±0.25pF	GQM22M5C2H1R5CB01#
			1.6pF	±0.1pF	GQM22M5C2H1R6BB01#
				±0.25pF	GQM22M5C2H1R6CB01#

T max.	Rated Voltage	TC Code	Cap.	Tol.	Part Number
1.35mm	500Vdc	C0G	1.8pF	±0.1pF	GQM22M5C2H1R8BB01#
				±0.25pF	GQM22M5C2H1R8CB01#
			2.0pF	±0.1pF	GQM22M5C2H2R0BB01#
				±0.25pF	GQM22M5C2H2R0CB01#
			2.2pF	±0.1pF	GQM22M5C2H2R2BB01#
				±0.25pF	GQM22M5C2H2R2CB01#
			2.4pF	±0.1pF	GQM22M5C2H2R4BB01#
				±0.25pF	GQM22M5C2H2R4CB01#
			2.7pF	±0.1pF	GQM22M5C2H2R7BB01#
				±0.25pF	GQM22M5C2H2R7CB01#
			3.0pF	±0.1pF	GQM22M5C2H3R0BB01#
				±0.25pF	GQM22M5C2H3R0CB01#
			3.3pF	±0.1pF	GQM22M5C2H3R3BB01#
				±0.25pF	GQM22M5C2H3R3CB01#
			3.6pF	±0.1pF	GQM22M5C2H3R6BB01#
				±0.25pF	GQM22M5C2H3R6CB01#
			3.9pF	±0.1pF	GQM22M5C2H3R9BB01#
				±0.25pF	GQM22M5C2H3R9CB01#
			4.0pF	±0.1pF	GQM22M5C2H4R0BB01#
				±0.25pF	GQM22M5C2H4R0CB01#
			4.3pF	±0.1pF	GQM22M5C2H4R3BB01#
				±0.25pF	GQM22M5C2H4R3CB01#
			4.7pF	±0.1pF	GQM22M5C2H4R7BB01#
				±0.25pF	GQM22M5C2H4R7CB01#
			5.0pF	±0.1pF	GQM22M5C2H5R0BB01#
				±0.25pF	GQM22M5C2H5R0CB01#
			5.1pF	±0.25pF	GQM22M5C2H5R1CB01#
				±0.5pF	GQM22M5C2H5R1DB01#
			5.6pF	±0.25pF	GQM22M5C2H5R6CB01#
				±0.5pF	GQM22M5C2H5R6DB01#
			6.0pF	±0.25pF	GQM22M5C2H6R0CB01#
				±0.5pF	GQM22M5C2H6R0DB01#
			6.2pF	±0.25pF	GQM22M5C2H6R2CB01#
				±0.5pF	GQM22M5C2H6R2DB01#
			6.8pF	±0.25pF	GQM22M5C2H6R8CB01#
				±0.5pF	GQM22M5C2H6R8DB01#
			7.0pF	±0.25pF	GQM22M5C2H7R0CB01#
				±0.5pF	GQM22M5C2H7R0DB01#
			7.5pF	±0.25pF	GQM22M5C2H7R5CB01#
				±0.5pF	GQM22M5C2H7R5DB01#
			8.0pF	±0.25pF	GQM22M5C2H8R0CB01#
				±0.5pF	GQM22M5C2H8R0DB01#
			8.2pF	±0.25pF	GQM22M5C2H8R2CB01#
				±0.5pF	GQM22M5C2H8R2DB01#
			9.0pF	±0.25pF	GQM22M5C2H9R0CB01#
				±0.5pF	GQM22M5C2H9R0DB01#
			9.1pF	±0.25pF	GQM22M5C2H9R1CB01#
				±0.5pF	GQM22M5C2H9R1DB01#
10pF	±2%	GQM22M5C2H100GB01#			
	±5%	GQM22M5C2H100JB01#			
11pF	±2%	GQM22M5C2H110GB01#			
	±5%	GQM22M5C2H110JB01#			
12pF	±2%	GQM22M5C2H120GB01#			
	±5%	GQM22M5C2H120JB01#			

For General Purpose GRM Series

Capacitor Array GNM Series

Low ESL LL□ Series

High-Q Type GJM Series

High Frequency GQM Series

Monolithic Microchip GMA Series

For Bonding GMD Series

Product Information

Part number # indicates the package specification code.

## GQM Series Temperature Compensating Type HiQ Part Number List

(→ ■ 2.8x2.8mm)

T max.	Rated Voltage	TC Code	Cap.	Tol.	Part Number
1.35mm	500Vdc	C0G	13pF	±2%	GQM22M5C2H130GB01#
				±5%	GQM22M5C2H130JB01#
			15pF	±2%	GQM22M5C2H150GB01#
				±5%	GQM22M5C2H150JB01#
			16pF	±2%	GQM22M5C2H160GB01#
				±5%	GQM22M5C2H160JB01#
			18pF	±2%	GQM22M5C2H180GB01#
				±5%	GQM22M5C2H180JB01#
			20pF	±2%	GQM22M5C2H200GB01#
				±5%	GQM22M5C2H200JB01#
			22pF	±2%	GQM22M5C2H220GB01#
				±5%	GQM22M5C2H220JB01#
			24pF	±2%	GQM22M5C2H240GB01#
				±5%	GQM22M5C2H240JB01#
			27pF	±2%	GQM22M5C2H270GB01#
				±5%	GQM22M5C2H270JB01#
			30pF	±2%	GQM22M5C2H300GB01#
				±5%	GQM22M5C2H300JB01#
			33pF	±2%	GQM22M5C2H330GB01#
				±5%	GQM22M5C2H330JB01#
			36pF	±2%	GQM22M5C2H360GB01#
				±5%	GQM22M5C2H360JB01#
			39pF	±2%	GQM22M5C2H390GB01#
				±5%	GQM22M5C2H390JB01#
			43pF	±2%	GQM22M5C2H430GB01#
				±5%	GQM22M5C2H430JB01#
			47pF	±2%	GQM22M5C2H470GB01#
				±5%	GQM22M5C2H470JB01#
			51pF	±2%	GQM22M5C2H510GB01#
				±5%	GQM22M5C2H510JB01#
			56pF	±2%	GQM22M5C2H560GB01#
				±5%	GQM22M5C2H560JB01#
			62pF	±2%	GQM22M5C2H620GB01#
				±5%	GQM22M5C2H620JB01#
			68pF	±2%	GQM22M5C2H680GB01#
				±5%	GQM22M5C2H680JB01#
			75pF	±2%	GQM22M5C2H750GB01#
				±5%	GQM22M5C2H750JB01#
			82pF	±2%	GQM22M5C2H820GB01#
				±5%	GQM22M5C2H820JB01#
			91pF	±2%	GQM22M5C2H910GB01#
				±5%	GQM22M5C2H910JB01#
100pF	±2%	GQM22M5C2H101GB01#			
	±5%	GQM22M5C2H101JB01#			

For General Purpose GRM Series

Capacitor Array GNM Series

Low ESL LLD Series

High-Q Type GJM Series

High Frequency GQM Series

Monolithic Microchip GMA Series

For Bonding GMD Series

Product Information

Part number # indicates the package specification code.

## Chip Monolithic Ceramic Capacitors

# Monolithic Microchip GMA Series

Capacitor for wire bonding. Can also be mounted directly to a frame!!

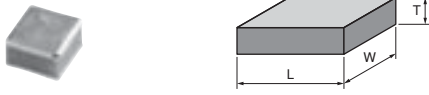

- 1 Excellent high frequency characteristics.
- 2 Ideal for bypass applications.
- 3 High density mounting is possible.

For General Purpose  
GRM Series

Capacitor Array  
GNM Series

Low ESL  
LLQ Series

High-Q Type  
GJM Series

High Frequency  
GQM Series

Monolithic Microchip  
GMA Series

For Bonding  
GMD Series

Product Information

## GMA Series High Dielectric Constant Type Part Number List

### ■ 0.38×0.38mm Ultra-compact

T max.	Rated Voltage	TC Code	Cap.	Tol.	Part Number
0.35mm	10Vdc	X7R	10000pF	±20%	GMA0D3R71A103MA01#
		R	10000pF	±20%	GMA0D3R11A103MA01#

### ■ 0.5×0.5mm Ultra-compact

T max.	Rated Voltage	TC Code	Cap.	Tol.	Part Number	
0.4mm	100Vdc	X7R	100pF	±20%	GMA05XR72A101MA01#	
			150pF	±20%	GMA05XR72A151MA01#	
			220pF	±20%	GMA05XR72A221MA01#	
			330pF	±20%	GMA05XR72A331MA01#	
			470pF	±20%	GMA05XR72A471MA01#	
			680pF	±20%	GMA05XR72A681MA01#	
			1000pF	±20%	GMA05XR72A102MA01#	
			25Vdc	X7R	1500pF	±20%
		2200pF	±20%		GMA05XR71E222MA11#	
		3300pF	±20%		GMA05XR71E332MA11#	
		4700pF	±20%		GMA05XR71E472MA11#	
		B	1500pF		±20%	GMA05XB31E152MA11#
			2200pF		±20%	GMA05XB31E222MA11#
			3300pF	±20%	GMA05XB31E332MA11#	
	4700pF		±20%	GMA05XB31E472MA11#		
	10Vdc	X7R	6800pF	±20%	GMA05XR71A682MA01#	
			10000pF	±20%	GMA05XR71A103MA01#	
			15000pF	±20%	GMA05XR71A153MA01#	
			22000pF	±20%	GMA05XR71A223MA01#	
			R	6800pF	±20%	GMA05XR11A682MA01#
				10000pF	±20%	GMA05XR11A103MA01#
		15000pF		±20%	GMA05XR11A153MA01#	
		22000pF		±20%	GMA05XR11A223MA01#	
		B	6800pF	±20%	GMA05XB11A682MA01#	
			10000pF	±20%	GMA05XB11A103MA01#	
			15000pF	±20%	GMA05XB11A153MA01#	
			22000pF	±20%	GMA05XB11A223MA01#	
		6.3Vdc	X5R	0.1μF	±20%	GMA05XR60J104ME12#
				B	0.1μF	±20%

### ■ 0.8×0.8mm

T max.	Rated Voltage	TC Code	Cap.	Tol.	Part Number
0.6mm	100Vdc	X7R	1500pF	±20%	GMA085R72A152MA01#
			2200pF	±20%	GMA085R72A222MA01#
			3300pF	±20%	GMA085R72A332MA01#
			4700pF	±20%	GMA085R72A472MA01#
			6800pF	±20%	GMA085R72A682MA01#
			25Vdc	X7R	10000pF
	15000pF	±20%	GMA085R71E153MA11#		
	22000pF	±20%	GMA085R71E223MA11#		
	B	10000pF	±20%		GMA085B31E103MA11#
		15000pF	±20%	GMA085B31E153MA11#	
		22000pF	±20%	GMA085B31E223MA11#	

T max.	Rated Voltage	TC Code	Cap.	Tol.	Part Number
0.6mm	10Vdc	X7R	33000pF	±20%	GMA085R71A333MA01#
			47000pF	±20%	GMA085R71A473MA01#
			68000pF	±20%	GMA085R71A683MA01#
			0.1μF	±20%	GMA085R71A104MA01#
		R	33000pF	±20%	GMA085R11A333MA01#
			47000pF	±20%	GMA085R11A473MA01#
			68000pF	±20%	GMA085R11A683MA01#
			0.1μF	±20%	GMA085R11A104MA01#
	6.3Vdc	X5R	33000pF	±20%	GMA085B11A333MA01#
			47000pF	±20%	GMA085B11A473MA01#
			68000pF	±20%	GMA085B11A683MA01#
		B	0.1μF	±20%	GMA085B11A104MA01#
			0.47μF	±20%	GMA085R60J474ME12#
			0.47μF	±20%	GMA085B30J474ME12#

Part number # indicates the package specification code.

For General Purpose GRM Series

Capacitor Array GNM Series

Low ESL LLD Series

High-Q Type GJM Series

High Frequency GQM Series

Monolithic Microchip GMA Series

For Bonding GMD Series

Product Information



## Chip Monolithic Ceramic Capacitors

# For Bonding GMD Series

Capacitor for wire bonding. Compatible up to 0.6x0.3mm size!!

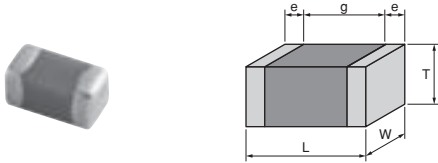

- 1 Compact product sizes of 0.6x0.3x0.3mm, 1.0x0.5x0.5mm
- 2 Can be mounted by wire bonding and AuSn soldering.
- 3 Ideal for mounting in optical communication related devices and IC packages.

For General Purpose  
GRM Series

Capacitor Array  
GNM Series

Low ESL  
LLQ Series

High-Q Type  
GJM Series

High Frequency  
GQM Series

Monolithic Microchip  
GMA Series

For Bonding  
GMD Series

Product Information

## GMD Series High Dielectric Constant Type Part Number List

**0.6x0.3mm** Ultra-compact

T max.	Rated Voltage	TC Code	Cap.	Tol.	Part Number	
0.33mm	25Vdc	X7R	100pF	±10%	GMD033R71E101KA01#	
			120pF	±10%	GMD033R71E121KA01#	
			150pF	±10%	GMD033R71E151KA01#	
			180pF	±10%	GMD033R71E181KA01#	
			220pF	±10%	GMD033R71E221KA01#	
			270pF	±10%	GMD033R71E271KA01#	
			330pF	±10%	GMD033R71E331KA01#	
			390pF	±10%	GMD033R71E391KA01#	
			470pF	±10%	GMD033R71E471KA01#	
			560pF	±10%	GMD033R71E561KA01#	
			680pF	±10%	GMD033R71E681KA01#	
			820pF	±10%	GMD033R71E821KA01#	
			1000pF	±10%	GMD033R71E102KA01#	
			1200pF	±10%	GMD033R71E122KA01#	
			1500pF	±10%	GMD033R71E152KA01#	
			R	100pF	±10%	GMD033R11E101KA01#
				120pF	±10%	GMD033R11E121KA01#
				150pF	±10%	GMD033R11E151KA01#
		180pF		±10%	GMD033R11E181KA01#	
		220pF		±10%	GMD033R11E221KA01#	
		270pF		±10%	GMD033R11E271KA01#	
		330pF		±10%	GMD033R11E331KA01#	
		390pF		±10%	GMD033R11E391KA01#	
		470pF		±10%	GMD033R11E471KA01#	
		560pF		±10%	GMD033R11E561KA01#	
		680pF		±10%	GMD033R11E681KA01#	
		820pF		±10%	GMD033R11E821KA01#	
		1000pF		±10%	GMD033R11E102KA01#	
		1200pF		±10%	GMD033R11E122KA01#	
		1500pF		±10%	GMD033R11E152KA01#	
		B		100pF	±10%	GMD033B11E101KA01#
				120pF	±10%	GMD033B11E121KA01#
				150pF	±10%	GMD033B11E151KA01#
			180pF	±10%	GMD033B11E181KA01#	
			220pF	±10%	GMD033B11E221KA01#	
			270pF	±10%	GMD033B11E271KA01#	
	330pF		±10%	GMD033B11E331KA01#		
	390pF		±10%	GMD033B11E391KA01#		
	470pF		±10%	GMD033B11E471KA01#		
	560pF		±10%	GMD033B11E561KA01#		
	680pF		±10%	GMD033B11E681KA01#		
	820pF		±10%	GMD033B11E821KA01#		
	1000pF		±10%	GMD033B11E102KA01#		
	1200pF		±10%	GMD033B11E122KA01#		
	1500pF		±10%	GMD033B11E152KA01#		
	16Vdc		X7R	1800pF	±10%	GMD033R71C182KA11#
				2200pF	±10%	GMD033R71C222KA11#
				2700pF	±10%	GMD033R71C272KA11#
		3300pF		±10%	GMD033R71C332KA11#	
		R		1800pF	±10%	GMD033R11C182KA11#
		2200pF	±10%	GMD033R11C222KA11#		
		2700pF	±10%	GMD033R11C272KA11#		

T max.	Rated Voltage	TC Code	Cap.	Tol.	Part Number	
0.33mm	16Vdc	R	3300pF	±10%	GMD033R11C332KA11#	
			B	1800pF	±10%	GMD033B31C182KA11#
			2200pF	±10%	GMD033B31C222KA11#	
			2700pF	±10%	GMD033B31C272KA11#	
		3300pF	±10%	GMD033B31C332KA11#		
		10Vdc	X7R	3900pF	±10%	GMD033R71A392KA01#
				4700pF	±10%	GMD033R71A472KA01#
				5600pF	±10%	GMD033R71A562KA01#
				6800pF	±10%	GMD033R71A682KA01#
				8200pF	±10%	GMD033R71A822KA01#
				10000pF	±10%	GMD033R71A103KA01#
				R	3900pF	±10%
	4700pF				±10%	GMD033R11A472KA01#
	5600pF				±10%	GMD033R11A562KA01#
	6800pF				±10%	GMD033R11A682KA01#
	8200pF		±10%		GMD033R11A822KA01#	
	10000pF		±10%		GMD033R11A103KA01#	
	B		3900pF		±10%	GMD033B11A392KA01#
			4700pF		±10%	GMD033B11A472KA01#
	6.3Vdc		X5R	56000pF	±10%	GMD033R60J563KE11#
				68000pF	±10%	GMD033R60J683KE11#
				82000pF	±10%	GMD033R60J823KE11#
				0.1µF	±10%	GMD033R60J104KE11#
		B		56000pF	±10%	GMD033B30J563KE11#
				68000pF	±10%	GMD033B30J683KE11#
			82000pF	±10%	GMD033B30J823KE11#	
			0.1µF	±10%	GMD033B30J104KE11#	

**1.0x0.5mm**

T max.	Rated Voltage	TC Code	Cap.	Tol.	Part Number	
0.55mm	50Vdc	X7R	220pF	±10%	GMD155R71H221KA01#	
			270pF	±10%	GMD155R71H271KA01#	
			330pF	±10%	GMD155R71H331KA01#	
			390pF	±10%	GMD155R71H391KA01#	
			470pF	±10%	GMD155R71H471KA01#	
			560pF	±10%	GMD155R71H561KA01#	
			680pF	±10%	GMD155R71H681KA01#	
			820pF	±10%	GMD155R71H821KA01#	
			1000pF	±10%	GMD155R71H102KA01#	
			1200pF	±10%	GMD155R71H122KA01#	
			1500pF	±10%	GMD155R71H152KA01#	
			1800pF	±10%	GMD155R71H182KA01#	
			2200pF	±10%	GMD155R71H222KA01#	
			2700pF	±10%	GMD155R71H272KA01#	
			3300pF	±10%	GMD155R71H332KA01#	
			3900pF	±10%	GMD155R71H392KA01#	
			4700pF	±10%	GMD155R71H472KA01#	
			R	220pF	±10%	GMD155R11H221KA01#

Part number # indicates the package specification code.

For General Purpose GRM Series  
 Capacitor Array GNM Series  
 Low ESL LL Series  
 High-Q Type GJM Series  
 High Frequency GQM Series  
 Monolithic Microchip GMA Series  
 For Bonding GMD Series  
 Product Information

## GMD Series High Dielectric Constant Type Part Number List

(→ ■ 1.0x0.5mm)

T max.	Rated Voltage	TC Code	Cap.	Tol.	Part Number	
0.55mm	50Vdc	R	270pF	±10%	GMD155R11H271KA01#	
			330pF	±10%	GMD155R11H331KA01#	
			390pF	±10%	GMD155R11H391KA01#	
			470pF	±10%	GMD155R11H471KA01#	
			560pF	±10%	GMD155R11H561KA01#	
			680pF	±10%	GMD155R11H681KA01#	
			820pF	±10%	GMD155R11H821KA01#	
			1000pF	±10%	GMD155R11H102KA01#	
			1200pF	±10%	GMD155R11H122KA01#	
			1500pF	±10%	GMD155R11H152KA01#	
			1800pF	±10%	GMD155R11H182KA01#	
			2200pF	±10%	GMD155R11H222KA01#	
			2700pF	±10%	GMD155R11H272KA01#	
			3300pF	±10%	GMD155R11H332KA01#	
			3900pF	±10%	GMD155R11H392KA01#	
			4700pF	±10%	GMD155R11H472KA01#	
			B	220pF	±10%	GMD155B11H221KA01#
		270pF		±10%	GMD155B11H271KA01#	
		330pF		±10%	GMD155B11H331KA01#	
		390pF		±10%	GMD155B11H391KA01#	
		470pF		±10%	GMD155B11H471KA01#	
		560pF		±10%	GMD155B11H561KA01#	
		680pF		±10%	GMD155B11H681KA01#	
		820pF		±10%	GMD155B11H821KA01#	
		1000pF		±10%	GMD155B11H102KA01#	
		1200pF		±10%	GMD155B11H122KA01#	
		1500pF	±10%	GMD155B11H152KA01#		
		1800pF	±10%	GMD155B11H182KA01#		
		2200pF	±10%	GMD155B11H222KA01#		
		2700pF	±10%	GMD155B11H272KA01#		
		3300pF	±10%	GMD155B11H332KA01#		
		3900pF	±10%	GMD155B11H392KA01#		
		4700pF	±10%	GMD155B11H472KA01#		
		25Vdc	X7R	5600pF	±10%	GMD155R71E562KA01#
				6800pF	±10%	GMD155R71E682KA01#
	8200pF			±10%	GMD155R71E822KA01#	
	10000pF			±10%	GMD155R71E103KA01#	
	12000pF			±10%	GMD155R71E123KA01#	
	15000pF			±10%	GMD155R71E153KA01#	
	18000pF			±10%	GMD155R71E183KA01#	
	22000pF			±10%	GMD155R71E223KA01#	
	27000pF			±10%	GMD155R71E273KA11#	
	33000pF			±10%	GMD155R71E333KA11#	
	39000pF			±10%	GMD155R71E393KA11#	
	47000pF			±10%	GMD155R71E473KA11#	
	R	5600pF	±10%	GMD155R11E562KA01#		
		6800pF	±10%	GMD155R11E682KA01#		
8200pF		±10%	GMD155R11E822KA01#			
10000pF		±10%	GMD155R11E103KA01#			
12000pF		±10%	GMD155R11E123KA01#			
15000pF		±10%	GMD155R11E153KA01#			
18000pF		±10%	GMD155R11E183KA01#			
22000pF		±10%	GMD155R11E223KA01#			
27000pF		±10%	GMD155R11E273KA11#			

T max.	Rated Voltage	TC Code	Cap.	Tol.	Part Number	
0.55mm	25Vdc	R	3300pF	±10%	GMD155R11E333KA11#	
			3900pF	±10%	GMD155R11E393KA11#	
			4700pF	±10%	GMD155R11E473KA11#	
			B	5600pF	±10%	GMD155B11E562KA01#
				6800pF	±10%	GMD155B11E682KA01#
				8200pF	±10%	GMD155B11E822KA01#
				10000pF	±10%	GMD155B11E103KA01#
		12000pF	±10%	GMD155B11E123KA01#		
		15000pF	±10%	GMD155B11E153KA01#		
		18000pF	±10%	GMD155B11E183KA01#		
		22000pF	±10%	GMD155B11E223KA01#		
		27000pF	±10%	GMD155B31E273KA11#		
		33000pF	±10%	GMD155B31E333KA11#		
		39000pF	±10%	GMD155B31E393KA11#		
		47000pF	±10%	GMD155B31E473KA11#		
		16Vdc	X7R	5600pF	±10%	GMD155R71C563KA11#
				6800pF	±10%	GMD155R71C683KA11#
				8200pF	±10%	GMD155R71C823KA11#
			R	0.1μF	±10%	GMD155R71C104KA11#
				56000pF	±10%	GMD155R11C563KA11#
				68000pF	±10%	GMD155R11C683KA11#
	B		82000pF	±10%	GMD155R11C823KA11#	
			0.1μF	±10%	GMD155R11C104KA11#	
			56000pF	±10%	GMD155B31C563KA11#	
			68000pF	±10%	GMD155B31C683KA11#	
	82000pF	±10%	GMD155B31C823KA11#			
	0.1μF	±10%	GMD155B31C104KA11#			
	10Vdc	X5R	0.12μF	±10%	GMD155R61A124KE12#	
			0.15μF	±10%	GMD155R61A154KE12#	
			0.18μF	±10%	GMD155R61A184KE12#	
			0.22μF	±10%	GMD155R61A224KE12#	
			0.27μF	±10%	GMD155R61A274KE11#	
			0.33μF	±10%	GMD155R61A334KE11#	
			0.39μF	±10%	GMD155R61A394KE11#	
			0.47μF	±10%	GMD155R61A474KE11#	
			B	0.12μF	±10%	GMD155B31A124KE12#
				0.15μF	±10%	GMD155B31A154KE12#
				0.18μF	±10%	GMD155B31A184KE12#
				0.22μF	±10%	GMD155B31A224KE12#
				0.27μF	±10%	GMD155B31A274KE11#
				0.33μF	±10%	GMD155B31A334KE11#
	0.39μF	±10%	GMD155B31A394KE11#			
	0.47μF	±10%	GMD155B31A474KE11#			

For General Purpose GRM Series

Capacitor Array GNM Series

Low ESL LL□ Series

High-Q Type GJM Series

High Frequency GQM Series

Monolithic Microchip GMA Series

For Bonding GMD Series

Product Information

Part number # indicates the package specification code.

**For General**

**⚠Caution/Notice**

**⚠Caution**

**Notice**

- Storage and Operation Conditions ..... 119
- Rating ..... 119
  - 1. Temperature Dependent Characteristics ..... 119
  - 2. Measurement of Capacitance ..... 120
  - 3. Applied Voltage ..... 120
  - 4. Applied Voltage and Self-heating Temperature ..... 120
  - 5. DC Voltage and AC Voltage Characteristic ..... 121
  - 6. Capacitance Aging ..... 121
  - 7. Vibration and Shock ..... 122
- Soldering and Mounting ..... 122
  - 1. Mounting Position ..... 122
  - 2. Information before Mounting ..... 123
  - 3. Maintenance of the Mounting (pick and place) Machine ..... 123
    - 4-1. Reflow Soldering ..... 124
    - 4-2. Flow Soldering ..... 125
    - 4-3. Correction with a Soldering Iron ..... 126
    - 4-4. Leaded Component Insertion ..... 126
  - 5. Washing ..... 126
  - 6. Electrical Test on Printed Circuit Board ..... 127
  - 7. Printed Circuit Board Cropping ..... 127
- Others ..... 128
  - 1. Under Operation of Equipment ..... 128
  - 2. Others ..... 128

- Rating ..... 129
  - 1. Operating Temperature ..... 129
  - 2. Atmosphere Surroundings ..... 129
  - 3. Piezo-electric Phenomenon ..... 129
- Soldering and Mounting ..... 129
  - 1. PCB Design ..... 129
    - 1. Notice for Pattern Forms ..... 129
    - 2. Land Dimensions ..... 130
  - 2. Adhesive Application ..... 131
  - 3. Adhesive Curing ..... 132
  - 4. Flux Application ..... 132
  - 5. Flow Soldering ..... 132
  - 6. Washing ..... 132
  - 7. Coating ..... 133
  - 8. Die Bonding/Wire Bonding (GMA or GMD Series) ..... 133
- Others ..... 133
  - 1. Transportation ..... 133

For General Purpose GRM Series

Capacitor Array GNM Series

Low ESL LLI Series

High-Q Type GJM Series

High Frequency GQM Series

Monolithic Microchip GMA Series

For Bonding GMD Series

Product Information  
 ⚠Caution/Notice



## ■ Storage and Operation Conditions

1. The performance of chip monolithic ceramic capacitors may be affected by the storage conditions.

1-1. Store capacitors in the following conditions:

Temperature of +5°C to +40°C and a Relative Humidity of 20% to 70%.

(1) Sunlight, dust, rapid temperature changes, corrosive gas atmosphere or high temperature and humidity conditions during storage may affect solderability and packaging performance. Please use product within six months of receipt.

(2) Please confirm solderability before using after six months. Store the capacitors without opening the original bag. Even if the storage period is short, do not exceed the specified atmospheric conditions.

1-2. Corrosive gas can react with the termination (external) electrodes or lead wires of capacitors, and result in poor solderability. Do not store the capacitors in an atmosphere consisting of corrosive gas (e.g., hydrogen sulfide, sulfur dioxide, chlorine, ammonia gas, etc.).

1-3. Due to moisture condensation caused by rapid humidity changes, or the photochemical change caused by direct sunlight on the terminal electrodes and/or the resin/epoxy coatings, the solderability and electrical performance may deteriorate. Do not store capacitors under direct sunlight or in high humidity conditions.

## ■ Rating

### 1. Temperature Dependent Characteristics

1. The electrical characteristics of the capacitor can change with temperature.

1-1. For capacitors having larger temperature dependency, the capacitance may change with temperature changes.

The following actions are recommended in order to ensure suitable capacitance values.

(1) Select a suitable capacitance for the operating temperature range.

(2) The capacitance may change within the rated temperature.

When you use a high dielectric constant type capacitor in a circuit that needs a tight (narrow) capacitance tolerance (e.g., a time-constant circuit), please carefully consider the characteristics of these capacitors, such as their aging, voltage, and temperature characteristics. In addition, check capacitors using your actual appliances at the intended environment and operating conditions.

Typical Temperature Characteristics R6(X5R)

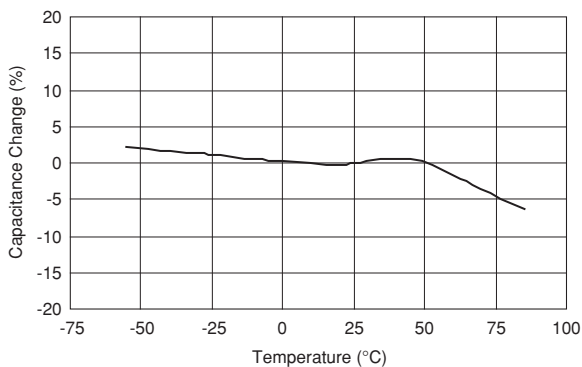

Typical Temperature Characteristics R7(X7R)

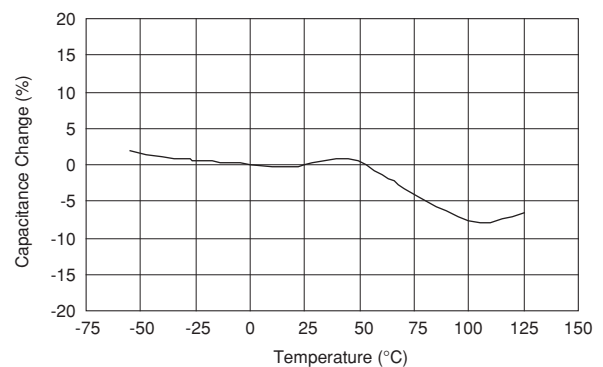

Typical Temperature Characteristics F5(Y5V)

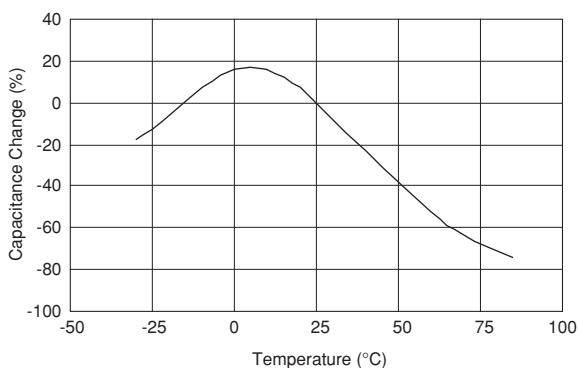

For General Purpose  
GRM Series

Capacitor Array  
GNM Series

Low ESL  
LL□ Series

High-Q Type  
GJM Series

High Frequency  
GQM Series

Monolithic Microchip  
GMA Series

For Bonding  
GMD Series

Product Information  
⚠Caution



**⚠Caution**

↳ Continued from the preceding page.

**2. Measurement of Capacitance**

1. Measure capacitance with the voltage and the frequency specified in the product specifications.

- 1-1. The output voltage of the measuring equipment may decrease occasionally when capacitance is high. Please confirm whether a prescribed measured voltage is impressed to the capacitor.

1-2. The capacitance values of high dielectric constant type capacitors change depending on the AC voltage applied. Please consider the AC voltage characteristics when selecting a capacitor to be used in an AC circuit.

**3. Applied Voltage**

1. Do not apply a voltage to the capacitor that exceeds the rated voltage as called out in the specifications.

- 1-1. Applied voltage between the terminals of a capacitor shall be less than or equal to the rated voltage.
  - (1) When AC voltage is superimposed on DC voltage, the zero-to-peak voltage shall not exceed the rated DC voltage. When AC voltage or pulse voltage is applied, the peak-to-peak voltage shall not exceed the rated DC voltage.
  - (2) Abnormal voltages (surge voltage, static electricity, pulse voltage, etc.) shall not exceed the rated DC voltage.

Typical Voltage Applied to the DC Capacitor

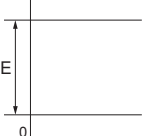
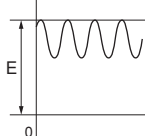
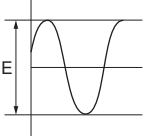
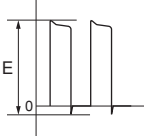
DC Voltage	DC Voltage+AC	AC Voltage	Pulse Voltage
			

(E: Maximum possible applied voltage.)

1-2. Influence of overvoltage

Overvoltage that is applied to the capacitor may result in an electrical short circuit caused by the breakdown of the internal dielectric layers. The time duration until breakdown depends on the applied voltage and the ambient temperature.

**4. Applied Voltage and Self-heating Temperature**

1. When the capacitor is used in a high-frequency voltage, pulse voltage, application, be sure to take into account self-heating may be caused by resistant factors of the capacitor.

- 1-1. The load should be contained to the level such that when measuring at atmospheric temperature of 25°C, the product's self-heating remains below 20°C and surface temperature of the capacitor in the actual circuit remains within the maximum operating temperature.

Continued on the following page. ↗

For General Purpose GRM Series  
 Capacitor Array GNM Series  
 Low ESL LLQ Series  
 High-Q Type GJM Series  
 High Frequency GQM Series  
 Monolithic Microchip GMA Series  
 For Bonding GMD Series  
 Product Information ⚠Caution



↳ Continued from the preceding page.

### 5. DC Voltage and AC Voltage Characteristics

1. The capacitance value of a high dielectric constant type capacitor changes depending on the DC voltage applied. Please consider the DC voltage characteristics when a capacitor is selected for use in a DC circuit.

1-1. The capacitance of ceramic capacitors may change sharply depending on the applied voltage (see figure).

Please confirm the following in order to secure the capacitance.

- (1) Determine whether the capacitance change caused by the applied voltage is within the allowed range.
- (2) In the DC voltage characteristics, the rate of capacitance change becomes larger as voltage increases, even if the applied voltage is below the rated voltage. When a high dielectric constant type capacitor is in a circuit that needs a tight (narrow) capacitance tolerance (e.g., a time-constant circuit), please carefully consider the characteristics of these capacitors, such as their aging, voltage, and temperature characteristics. In addition, check capacitors using your actual appliances at the intended environment and operating conditions.

2. The capacitance values of high dielectric constant type capacitors change depending on the AC voltage applied. Please consider the AC voltage characteristics when selecting a capacitor to be used in an AC circuit.

[DC Voltage Characteristics]

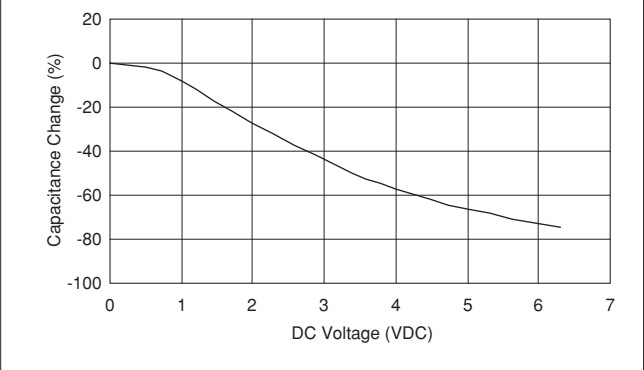

[AC Voltage Characteristics]

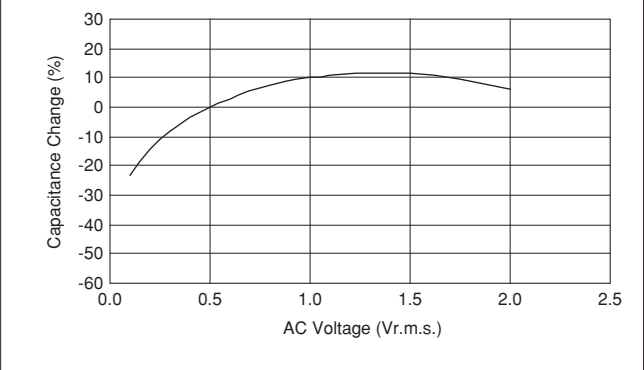

### 6. Capacitance Aging

1. The high dielectric constant type capacitors have the characteristic in which the capacitance value decreases with the passage of time.

When you use a high dielectric constant type capacitors in a circuit that needs a tight (narrow) capacitance tolerance (e.g., a time-constant circuit), please carefully consider the characteristics of these capacitors, such as their aging, voltage, and temperature characteristics. In addition, check capacitors using your actual appliances at the intended environment and operating conditions.

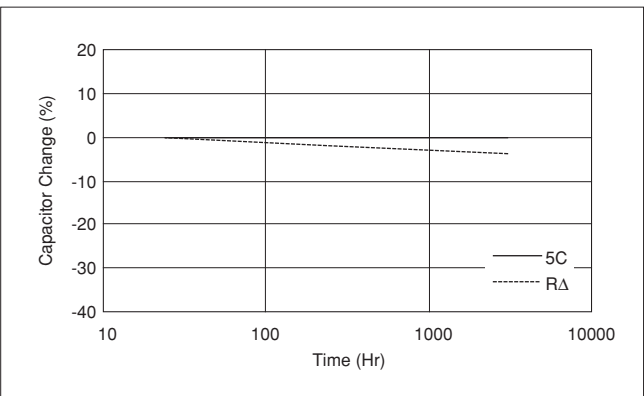

Continued on the following page. ↗

For General Purpose  
GRM Series

Capacitor Array  
GJM Series

Low ESL  
LLQ Series

High-Q Type  
GJM Series

High Frequency  
GQM Series

Monolithic Microchip  
GMA Series

For Bonding  
GMD Series

Product Information  
⚠Caution

## ⚠Caution

☐ Continued from the preceding page.

### 7. Vibration and Shock

1. Please confirm the kind of vibration and/or shock, its condition, and any generation of resonance.  
 Please mount the capacitor so as not to generate resonance, and do not allow any impact on the terminals.
2. Mechanical shock due to being dropped may cause damage or a crack in the dielectric material of the capacitor.  
 Do not use a dropped capacitor because the quality and reliability may be deteriorated.
3. When printed circuit boards are piled up or handled, the corner of another printed circuit board should not be allowed to hit the capacitor, in order to avoid a crack or other damage to the capacitor.

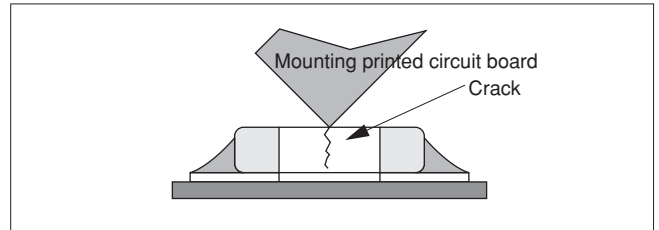
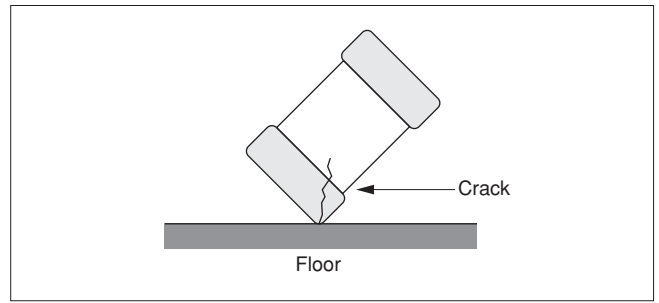

### ■ Soldering and Mounting

#### 1. Mounting Position

1. Confirm the best mounting position and direction that minimizes the stress imposed on the capacitor during flexing or bending the printed circuit board.
  - 1-1. Choose a mounting position that minimizes the stress imposed on the chip during flexing or bending of the board.

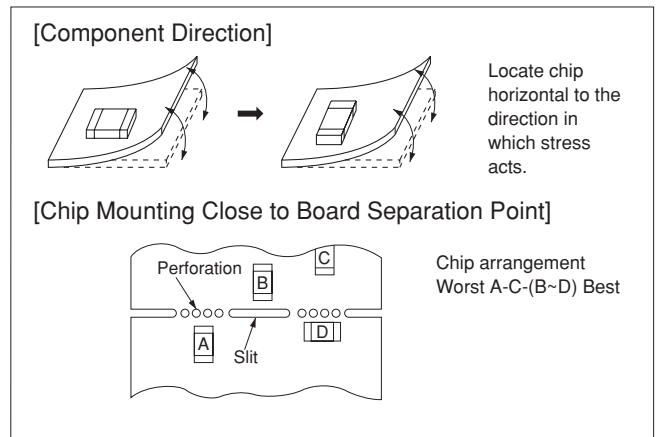

Continued on the following page. ↗

For General Purpose GRM Series  
 Capacitor Array GNM Series  
 Low ESL LLQ Series  
 High-Q Type GJM Series  
 High Frequency GQM Series  
 Monolithic Microchip GMA Series  
 For Bonding GMD Series  
 Product Information ⚠Caution

**⚠Caution**

☐ Continued from the preceding page.

## 2. Information before Mounting

1. Do not reuse capacitors that were removed from the equipment.
2. Confirm capacitance characteristics under actual applied voltage.
3. Confirm the mechanical stress under actual process and equipment use.
4. Confirm the rated capacitance, rated voltage and other electrical characteristics before assembly.
5. Prior to use, confirm the solderability of capacitors that were in long-term storage.
6. Prior to measuring capacitance, carry out a heat treatment for capacitors that were in long-term storage.
7. The use of Sn-Zn based solder will deteriorate the reliability of the MLCC.

Please contact our sales representative or product engineers on the use of Sn-Zn based solder in advance.

## 3. Maintenance of the Mounting (pick and place) Machine

1. Make sure that the following excessive forces are not applied to the capacitors.
  - 1-1. In mounting the capacitors on the printed circuit board, any bending force against them shall be kept to a minimum to prevent them from any bending damage or cracking. Please take into account the following precautions and recommendations for use in your process.
    - (1) Adjust the lowest position of the pickup nozzle so as not to bend the printed circuit board.
    - (2) Adjust the nozzle pressure within a static load of 1N to 3N during mounting.
2. Dirt particles and dust accumulated between the suction nozzle and the cylinder inner wall prevent the nozzle from moving smoothly. This imposes greater force upon the chip during mounting, causing cracked chips. Also, the locating claw, when worn out, imposes uneven forces on the chip when positioning, causing cracked chips. The suction nozzle and the locating claw must be maintained, checked and replaced periodically.

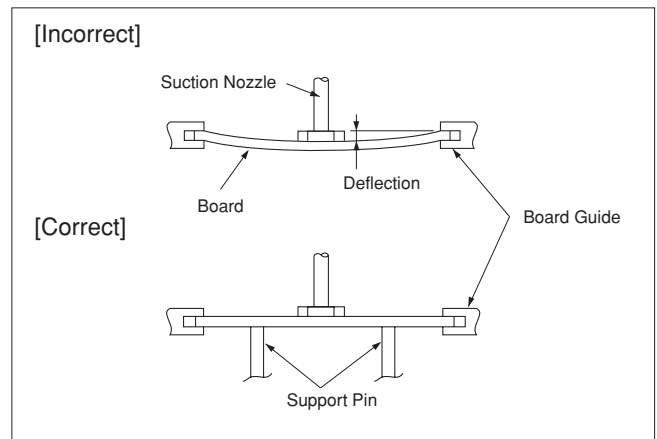

Continued on the following page. ↗

For General Purpose  
GRM Series

Capacitor Array  
GNM Series

Low ESL  
LLC Series

High-Q Type  
GJM Series

High Frequency  
GQM Series

Monolithic Microchip  
GMA Series

For Bonding  
GMD Series

Product Information  
⚠Caution

**⚠Caution**

☐ Continued from the preceding page.

**4-1. Reflow Soldering**

- When sudden heat is applied to the components, the mechanical strength of the components will decrease because a sudden temperature change causes deformation inside the components. In order to prevent mechanical damage to the components, preheating is required for both the components and the PCB board. Preheating conditions are shown in table 1. It is required to keep the temperature differential between the solder and the component's surface ( $\Delta T$ ) as small as possible.
- Solderability of tin plating termination chips might be deteriorated when a low temperature soldering profile where the peak solder temperature is below the melting point of tin is used. Please confirm the solderability of tin plated termination chips before use.
- When components are immersed in solvent after mounting, be sure to maintain the temperature difference ( $\Delta T$ ) between the component and the solvent within the range shown in the table 1.

**Table 1**

Part Number	Temperature Differential
GRM02/03/15/18/21/31 GJM02/03/15 LLL15/18/21/31 LLR18 GQM18/21	$\Delta T \leq 190^\circ\text{C}$
GRM32/43/55 LLA18/21/31 LLM21/31 GNM GQM22	$\Delta T \leq 130^\circ\text{C}$

**Recommended Conditions**

	Pb-Sn Solder		Lead Free Solder
	Infrared Reflow	Vapor Reflow	
Peak Temperature	230 to 250°C	230 to 240°C	240 to 260°C
Atmosphere	Air	Air	Air or N <sub>2</sub>

Pb-Sn Solder: Sn-37Pb  
 Lead Free Solder: Sn-3.0Ag-0.5Cu

**4. Optimum Solder Amount for Reflow Soldering**

- Overly thick application of solder paste results in a excessive solder fillet height. This makes the chip more susceptible to mechanical and thermal stress on the board and may cause the chips to crack.
- Too little solder paste results in a lack of adhesive strength on the outer electrode, which may result in chips breaking loose from the PCB.
- Make sure the solder has been applied smoothly to the end surface to a height of 0.2mm\* min.

**Inverting the PCB**

Make sure not to impose any abnormal mechanical shocks to the PCB.

**[Standard Conditions for Reflow Soldering]**

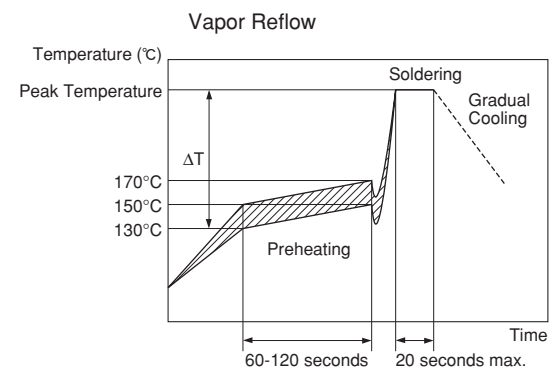
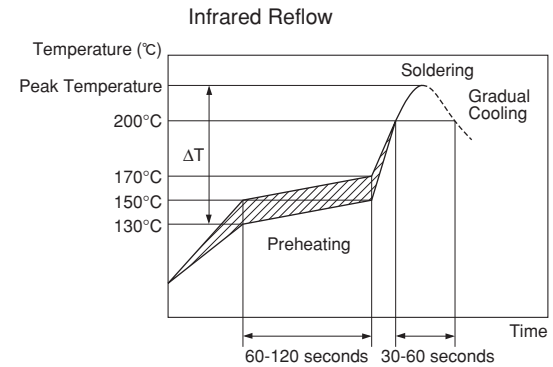

**[Allowable Reflow Soldering Temperature and Time]**

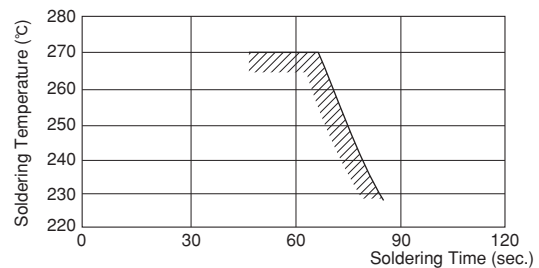

In the case of repeated soldering, the accumulated soldering time must be within the range shown above.

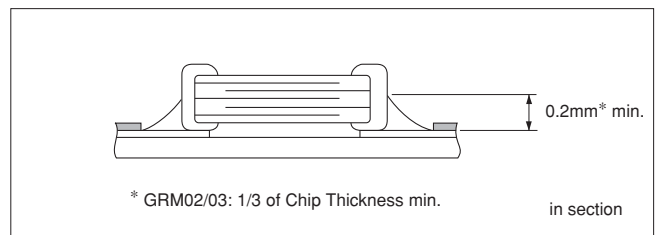

For General Purpose GRM Series  
 Capacitor Array GNM Series  
 Low ESL LLL Series  
 High-Q Type GJM Series  
 High Frequency GQM Series  
 Monolithic Microchip GMA Series  
 For Bonding GMD Series  
 Product Information ⚠Caution



**⚠Caution**

☞ Continued from the preceding page.

**4-2. Flow Soldering**

1. When sudden heat is applied to the components, the mechanical strength of the components will decrease because a sudden temperature change causes deformation inside the components. In order to prevent mechanical damage in the components, preheating should be required for both of the components and the PCB board.  
 Preheating conditions are shown in table 2. It is required to keep the temperature differential between the solder and the component's surface ( $\Delta T$ ) as small as possible.
2. Excessively long soldering time or high soldering temperature can result in leaching of the outer electrodes, causing poor adhesion or a reduction in capacitance value due to loss of contact between electrodes and end termination.
3. When components are immersed in solvent after mounting, be sure to maintain the temperature difference ( $\Delta T$ ) between the component and solvent within the range shown in the table 2.
4. Do not apply flow soldering to chips not listed in table 2.

**Table 2**

Part Number	Temperature Differential
GRM18/21/31	$\Delta T \leq 150^\circ\text{C}$
LLL21/31	
GQM18/21	

**Recommended Conditions**

	Pb-Sn Solder	Lead Free Solder
Preheating Peak Temperature	90 to 110°C	100 to 120°C
Soldering Peak Temperature	240 to 250°C	250 to 260°C
Atmosphere	Air	N <sub>2</sub>

Pb-Sn Solder: Sn-37Pb

Lead Free Solder: Sn-3.0Ag-0.5Cu

**5. Optimum Solder Amount for Flow Soldering**

- 5-1. The top of the solder fillet should be lower than the thickness of components. If the solder amount is excessive, the risk of cracking is higher during board bending or any other stressful condition.

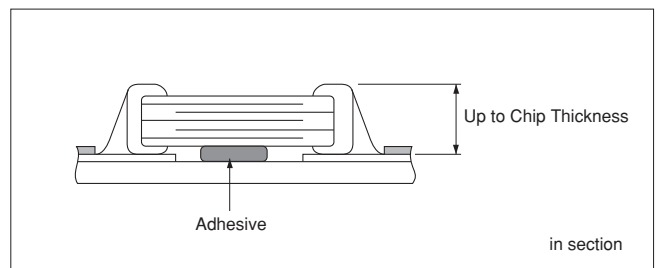
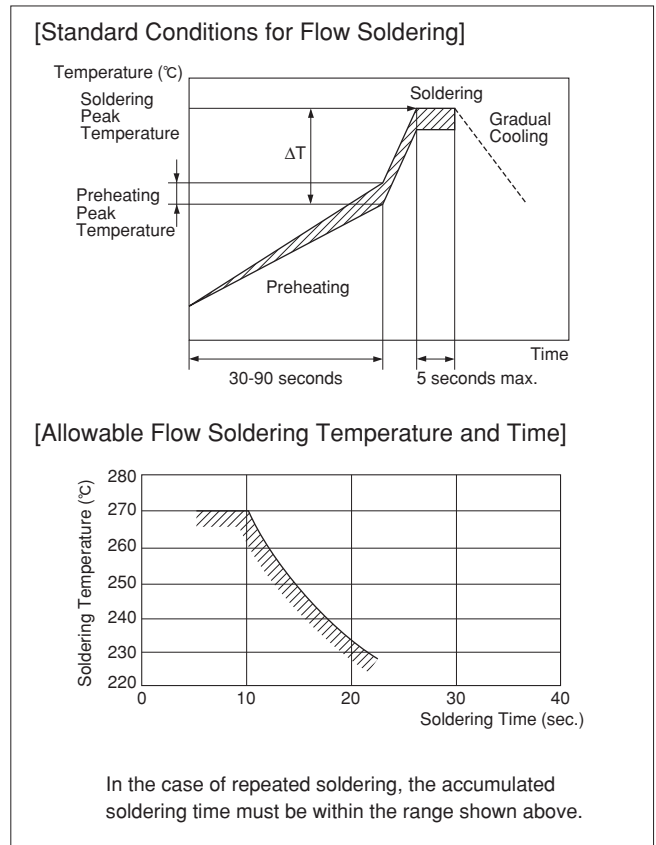

Continued on the following page. ☞

For General Purpose GRM Series  
 Capacitor Array GNM Series  
 Low ESL LLL Series  
 High-Q Type GJM Series  
 High Frequency GQM Series  
 Monolithic Microchip GMA Series  
 For Bonding GMD Series  
 Product Information ⚠Caution

**⚠Caution**

☐ Continued from the preceding page.

**4-3. Correction with a Soldering Iron**

1. When sudden heat is applied to the components when using a soldering iron, the mechanical strength of the components will decrease because the extreme temperature change can cause deformations inside the components. In order to prevent mechanical damage to the components, preheating is required for both the components and the PCB board. Preheating conditions (The "Temperature of the Soldering Iron Tip", "Preheating Temperature," "Temperature Differential" between the iron tip and the components and the PCB), should be within the conditions of table 3. It is required to keep the temperature differential between the soldering iron and the component surfaces ( $\Delta T$ ) as small as possible.
2. After soldering, do not allow the component/PCB to cool down rapidly.
3. The operating time for the re-working should be as short as possible. When re-working time is too long, it may cause solder leaching, in turn causing a reduction in the adhesive strength of the terminations.
4. Optimum solder amount when re-working with a soldering iron
  - 4-1. For sizes smaller than 0603, (GRM03/15/18, GJM03/15, GQM18), the top of the solder fillet should be lower than  $\frac{2}{3}$  of the thickness of the component or 0.5mm whichever is smaller. For 0805 and larger sizes, (GRM21/31/32/43/55, GQM21/22), the top of the solder fillet should be lower than  $\frac{2}{3}$  of the thickness of the component. If the solder amount is excessive, the risk of cracking is higher during board bending or under any other stressful condition.
  - 4-2. A soldering iron with a tip of  $\phi 3\text{mm}$  or smaller should be used. It is also necessary to keep the soldering iron from touching the components during the re-work.
  - 4-3. Solder wire with  $\phi 0.5\text{mm}$  or smaller is required for soldering.

**4-4. Leaded Component Insertion**

1. If the PCB is flexed when leaded components (such as transformers and ICs) are being mounted, chips may crack and solder joints may break.  
 Before mounting leaded components, support the PCB using backup pins or special jigs to prevent warping.

**5. Washing**

Excessive ultrasonic oscillation during cleaning can cause the PCBs to resonate, resulting in cracked chips or broken solder joints. Take note not to vibrate PCBs.

**Table 3**

Part Number	Temperature of Soldering Iron Tip	Preheating Temperature	Temperature Differential ( $\Delta T$ )	Atmosphere
GRM03/15/18/21/31 GJM03/15 GQM18/21	350°C max.	150°C min.	$\Delta T \leq 190^\circ\text{C}$	Air
GRM32/43/55 GQM22	280°C max.	150°C min.	$\Delta T \leq 130^\circ\text{C}$	Air

\*Applicable for both Pb-Sn and Lead Free Solder.  
 Pb-Sn Solder: Sn-37Pb  
 Lead Free Solder: Sn-3.0Ag-0.5Cu

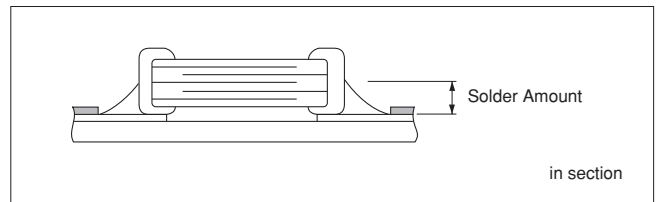

Continued on the following page. ☐

For General Purpose GRM Series  
 Capacitor Array GNM Series  
 Low ESL LL Series  
 High-Q Type GJM Series  
 High Frequency GQM Series  
 Monolithic Microchip GMA Series  
 For Bonding GMD Series  
 Product Information ⚠Caution

**⚠Caution**

☐ Continued from the preceding page.

**6. Electrical Test on Printed Circuit Board**

1. Confirm position of the support pin or specific jig, when inspecting the electrical performance of a capacitor after mounting on the printed circuit board.

1-1. Avoid bending the printed circuit board by the pressure of a test pin, etc.

The thrusting force of the test probe can flex the PCB, resulting in cracked chips or open solder joints. Provide support pins on the back side of the PCB to prevent warping or flexing.

1-2. Avoid vibration of the board by shock when a test pin contacts a printed circuit board.

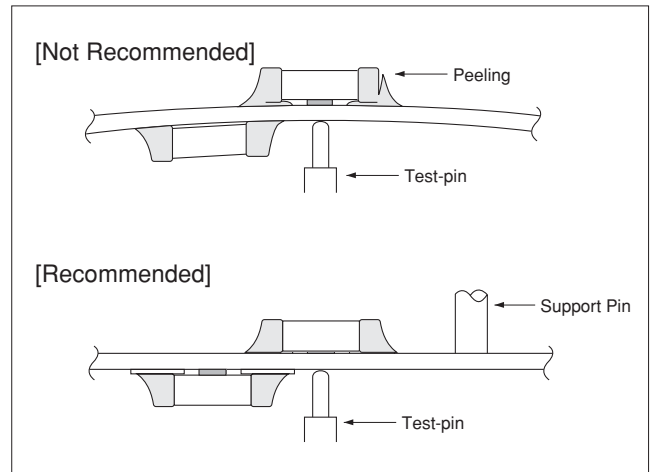

**7. Printed Circuit Board Cropping**

1. After mounting a capacitor on a printed circuit board, do not apply any stress to the capacitor that is caused by bending or twisting the board.

1-1. In cropping the board, the stress as shown at right may cause the capacitor to crack.

Try not to apply this type of stress to a capacitor.

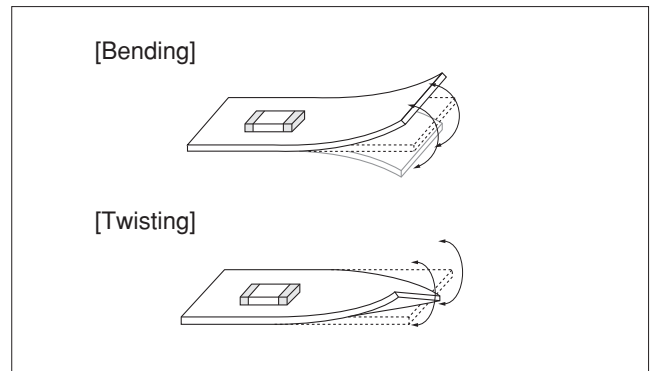

2. Ascertain of the cropping method for the printed circuit board in advance.

2-1. Printed circuit board cropping shall be carried out by using a jig or an apparatus to prevent the mechanical stress that can occur to the board.

(1) Example of a suitable jig

Recommended example: the board should be pushed as close to the cropping jig as possible and from the back side of board in order to minimize the compressive stress applied to the capacitor.

Not recommended example: when the board is pushed at a point far from the cropping jig and from the front side of board as below, the capacitor may form a crack caused by the tensile stress applied to capacitor.

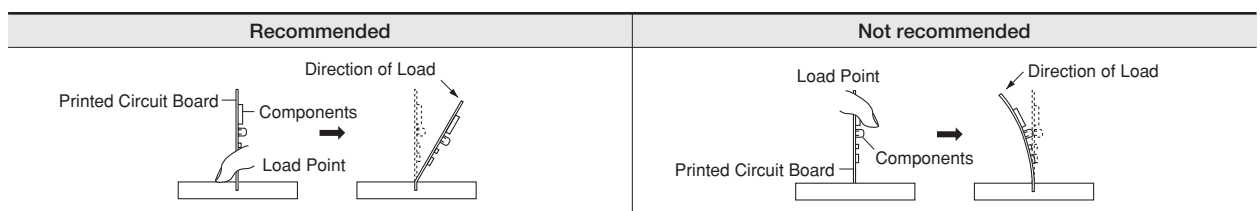
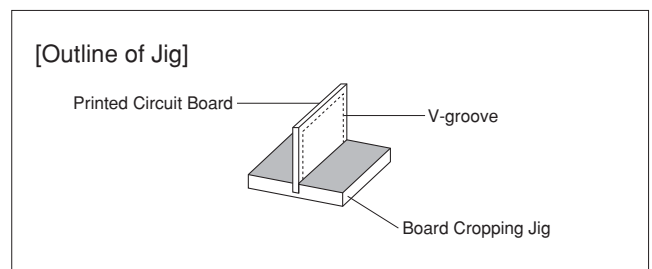

Continued on the following page. ☐

For General Purpose  
GRM Series

Capacitor Array  
GNM Series

Low ESL  
LL□ Series

High-Q Type  
GJM Series

High Frequency  
GQM Series

Monolithic Microchip  
GMA Series

For Bonding  
GMD Series

Product Information  
⚠Caution

**⚠Caution**

Continued from the preceding page.

(2) Example of a suitable machine

An outline of a printed circuit board cropping machine is shown as follows. Along the lines with the V-grooves on the printed circuit board, the top and bottom blades are aligned to one another when cropping the board.

The misalignment of the position between top and bottom blades may cause the capacitor to crack.

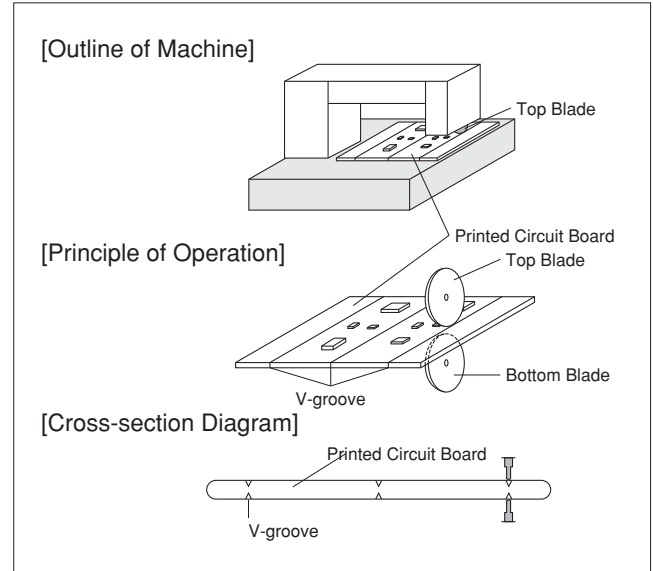

Recommended	Not Recommended		
	Top-bottom Misalignment	Left-right Misalignment	Front-rear Misalignment
<p>Top Blade</p> <p>Bottom Blade</p>	<p>Top Blade</p> <p>Bottom Blade</p>	<p>Top Blade</p> <p>Bottom Blade</p>	<p>Top Blade</p> <p>Bottom Blade</p>

■ Others

1. Under Operation of Equipment

- 1-1. Do not touch a capacitor directly with bare hands during operation in order to avoid the danger of an electric shock.
- 1-2. Do not allow the terminals of a capacitor to come in contact with any conductive objects (short-circuit). Do not expose a capacitor to a conductive liquid, including any acid or alkali solutions.
- 1-3. Confirm the environment in which the equipment will operate is under the specified conditions. Do not use the equipment under the following environments.
  - (1) Being spattered with water or oil.
  - (2) Being exposed to direct sunlight.
  - (3) Being exposed to Ozone, ultraviolet rays or radiation.
  - (4) Being exposed to toxic gas (e.g., hydrogen sulfide, sulfur dioxide, chlorine, ammonia gas, etc.)
  - (5) Any vibrations or mechanical shocks exceeding the specified limits.
  - (6) Moisture condensing environments.
- 1-4. Use damp proof countermeasures if using under any conditions that can cause condensation.

2. Others

- 2-1. In an Emergency
  - (1) If the equipment should generate smoke, fire or smell, immediately turn off or unplug the equipment.

If the equipment is not turned off or unplugged, the hazards may be worsened by supplying continuous power.

- (2) In this type of situation, do not allow face and hands to come in contact with the capacitor or burns may be caused by the capacitor's high temperature.

2-2. Disposal of Waste

When capacitors are disposed, they must be burned or buried by an industrial waste vendor with the appropriate licenses.

2-3. Circuit Design

GRM, GCM, GMA/D, LLL/A/M, GQM, GJM, GNM Series capacitors in this catalog are not safety certified products.

2-4. Remarks

Failure to follow the cautions may result, worst case, in a short circuit and smoking when the product is used.

The above notices are for standard applications and conditions. Contact us when the products are used in special mounting conditions.

Select optimum conditions for operation as they determine the reliability of the product after assembly. The data herein are given in typical values, not guaranteed ratings.

For General Purpose GRM Series  
 Capacitor Array GNM Series  
 Low ESL LLL Series  
 High-Q Type GJM Series  
 High Frequency GQM Series  
 Monolithic Microchip GMA Series  
 For Bonding GMD Series  
 Product Information ⚠Caution

**Notice**

**Rating**

1. Operating Temperature

1. The operating temperature limit depends on the capacitor.

1-1. Do not apply temperatures exceeding the upper operating temperature.

It is necessary to select a capacitor with a suitable rated temperature that will cover the operating temperature range.

It is also necessary to consider the temperature distribution in equipment and the seasonal temperature variable factor.

1-2. Consider the self-heating factor of the capacitor.

The surface temperature of the capacitor shall be the upper operating temperature or less when including the self-heating factors.

2. Atmosphere Surroundings (gaseous and liquid)

1. Restriction on the operating environment of capacitors.

1-1. Capacitors, when used in the above, unsuitable,

operating environments may deteriorate due to the corrosion of the terminations and the penetration of moisture into the capacitor.

1-2. The same phenomenon as the above may occur when the electrodes or terminals of the capacitor are subject to moisture condensation.

1-3. The deterioration of characteristics and insulation resistance due to the oxidization or corrosion of terminal electrodes may result in breakdown when the capacitor is exposed to corrosive or volatile gases or solvents for long periods of time.

3. Piezo-electric Phenomenon

1. When using high dielectric constant type capacitors in AC or pulse circuits, the capacitor itself vibrates at specific frequencies and noise may be generated. Moreover, when the mechanical vibration or shock is added to the capacitor, noise may occur.

**Soldering and Mounting**

1. PCB Design

1. Notice for Pattern Forms

1-1. Unlike leaded components, chip components are susceptible to flexing stresses since they are mounted directly on the substrate.

They are also more sensitive to mechanical and thermal stresses than leaded components.

Excess solder fillet height can multiply these stresses and cause chip cracking. When designing substrates, take land patterns and dimensions into consideration to eliminate the possibility of excess solder fillet height.

1-2. There is a possibility of chip crack caused by PCB expansion/contraction with heat. Because stress for chip is different depend on PCB material and structure. Especially metal PCB such as alumina has a greater risk of chip crack because of large difference of thermal expansion coefficient. In case of chip below 0402 size, there is also the same possibility of crack with a single-layered glass epoxy board.

**Pattern Forms**

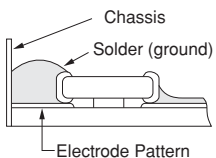
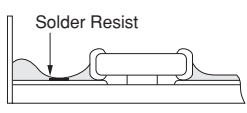
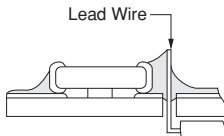
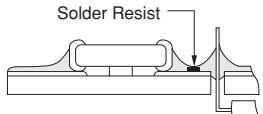
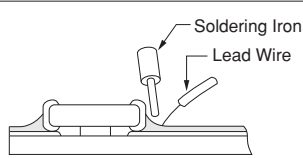
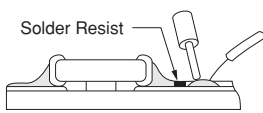
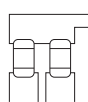
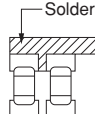
	Prohibited	Correct
Placing Close to Chassis		
Placing of Chip Components and Leaded Components		
Placing of Leaded Components after Chip Component		
Lateral Mounting		

Continued on the following page. ↗

For General Purpose  
GRM Series

Capacitor Array  
GNM Series

Low ESL  
LL□ Series

High-Q Type  
GJM Series

High Frequency  
GQM Series

Monolithic Microchip  
GMA Series

For Bonding  
GMD Series

Product Information  
Notice



## Notice

☐ Continued from the preceding page.

### 2. Land Dimensions

2-1. A chip capacitor can be cracked due to the stress of PCB bending, etc. if the land area is larger than needed and has an excess amount of solder. Please refer to the land dimensions in table 1 for flow soldering, table 2 for reflow soldering, table 3 for GNM & LLA, and table 4 for LLM. Please confirm the suitable land dimension by evaluating the actual SET / PCB.

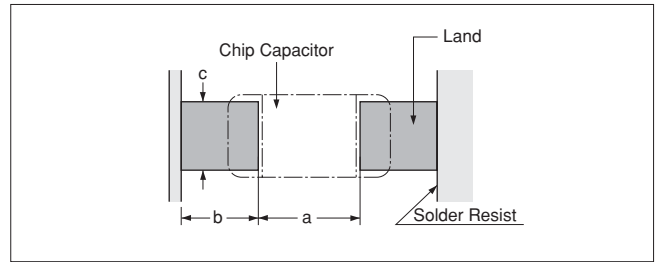

**Table 1 Flow Soldering Method**

Part Number	Dimensions	Chip (L×W)	a	b	c
<b>GRM18</b> <b>GQM18</b>		1.6×0.8	0.6 to 1.0	0.8 to 0.9	0.6 to 0.8
<b>GRM21</b> <b>GQM21</b>		2.0×1.25	1.0 to 1.2	0.9 to 1.0	0.8 to 1.1
<b>GRM31</b>		3.2×1.6	2.2 to 2.6	1.0 to 1.1	1.0 to 1.4
<b>LLL21</b>		1.25×2.0	0.4 to 0.7	0.5 to 0.7	1.4 to 1.8
<b>LLL31</b>		1.6×3.2	0.6 to 1.0	0.8 to 0.9	2.6 to 2.8

(in mm)

**Table 2 Reflow Soldering Method**

Part Number	Dimensions	Chip (L×W)	a	b	c
<b>GRM02</b> <b>GJM02</b>		0.4×0.2	0.16 to 0.2	0.12 to 0.18	0.2 to 0.23
<b>GRM03</b> <b>GJM03</b>		0.6×0.3	0.2 to 0.3	0.2 to 0.35	0.2 to 0.4
<b>GRM15</b> <b>GJM15</b>		1.0×0.5 (within ±0.10)	0.3 to 0.5	0.35 to 0.45	0.4 to 0.6
		1.0×0.5 (±0.15/±0.20)	0.4 to 0.6	0.40 to 0.50	0.5 to 0.7
<b>GRM18</b> <b>GQM18</b>		1.6×0.8 (within ±0.10)	0.6 to 0.8	0.6 to 0.7	0.6 to 0.8
		1.6×0.8 (±0.15/±0.20)	0.7 to 0.9	0.7 to 0.8	0.8 to 1.0
<b>GQM21</b>		2.0×1.25	1.0 to 1.2	0.6 to 0.7	0.8 to 1.1
<b>GRM21</b>		2.0×1.25 (within ±1.0)	1.2	0.6	1.25
		2.0×1.25 (±0.15)	1.2	0.6 to 0.8	1.2 to 1.4
		2.0×1.25 (±0.20)	1.0 to 1.4	0.6 to 0.8	1.2 to 1.4
<b>GRM31</b>		3.2×1.6 (within ±0.20)	1.8 to 2.0	0.9 to 1.2	1.5 to 1.7
		3.2×1.6 (±0.30)	1.9 to 2.1	1.0 to 1.3	1.7 to 1.9
<b>GRM32</b>		3.2×2.5	2.0 to 2.4	1.0 to 1.2	1.8 to 2.3
<b>GRM43</b>		4.5×3.2	3.0 to 3.5	1.2 to 1.4	2.3 to 3.0
<b>GRM55</b>		5.7×5.0	4.0 to 4.6	1.4 to 1.6	3.5 to 4.8
<b>LLL15</b>		0.5×1.0	0.15 to 0.2	0.2 to 0.25	0.7 to 1.0
<b>LLL18</b> <b>LLR18</b>		0.8×1.6	0.2 to 0.3	0.3 to 0.4	1.4 to 1.6
<b>LLL21</b>		1.25×2.0	0.4 to 0.6	0.4 to 0.5	1.4 to 1.8
<b>LLL31</b>		1.6×3.2	0.6 to 0.8	0.6 to 0.7	2.6 to 2.8
<b>GQM22</b>		2.8×2.8	2.2 to 2.5	0.8 to 1.0	1.9 to 2.3

(in mm)

Continued on the following page. ☐

For General Purpose GRM Series  
 Capacitor Array GNM Series  
 Low ESL LLL Series  
 High-Q Type GJM Series  
 High Frequency GQM Series  
 Monolithic Microchip GMA Series  
 For Bonding GMD Series  
 Product Information Notice

**Notice**

Continued from the preceding page.

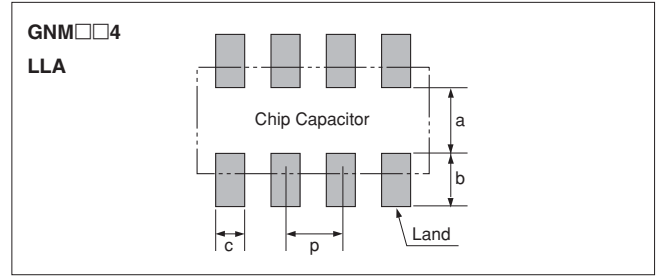
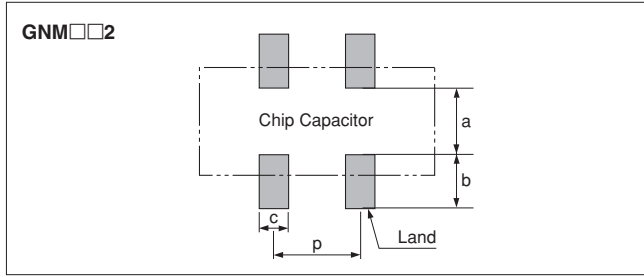

**Table 3 GNM, LLA Series for Reflow Soldering Land Dimensions**

Part Number	Dimensions (mm)					
	L	W	a	b	c	p
<b>GNM0M2</b>	0.9	0.6	0.12 to 0.20*	0.35 to 0.40*	0.3	0.45
<b>GNM1M2</b>	1.37	1.0	0.4 to 0.5	0.35 to 0.45	0.3 to 0.35	0.64
<b>GNM212</b>	2.0	1.25	0.6 to 0.7	0.5 to 0.7	0.4 to 0.5	1.0
<b>GNM214</b>	2.0	1.25	0.6 to 0.7	0.5 to 0.7	0.25 to 0.35	0.5
<b>GNM314</b>	3.2	1.6	0.8 to 1.0	0.7 to 0.9	0.3 to 0.4	0.8
<b>LLA18</b>	1.6	0.8	0.3 to 0.4	0.25 to 0.35	0.15 to 0.25	0.4
<b>LLA21</b>	2.0	1.25	0.5 to 0.7	0.35 to 0.6	0.2 to 0.3	0.5
<b>LLA31</b>	3.2	1.6	0.7 to 0.9	0.4 to 0.7	0.3 to 0.4	0.8

\*  $0.82 \leq a+2b \leq 1.00$

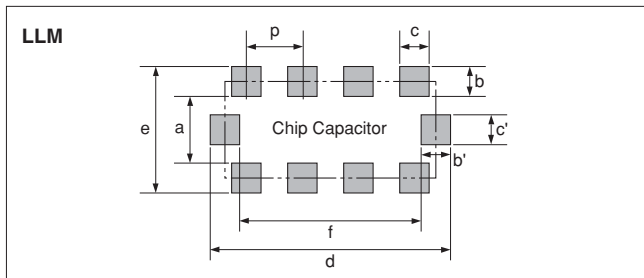

**Table 4 LLM Series for Reflow Soldering Land Dimensions**

Part Number	Dimensions (mm)						
	a	b, b'	c, c'	d	e	f	p
<b>LLM21</b>	0.6 to 0.8	(0.3 to 0.5)	0.3	2.0 to 2.6	1.3 to 1.8	1.4 to 1.6	0.5
<b>LLM31</b>	1.0	(0.3 to 0.5)	0.4	3.2 to 3.6	1.6 to 2.0	2.6	0.8

$b=(c-e)/2, b'=(d-f)/2$

**2. Adhesive Application**

- Thin or insufficient adhesive can cause the chips to loosen or become disconnected during flow soldering. The amount of adhesive must be more than dimension c, shown in the drawing at right, to obtain the correct bonding strength. The chip's electrode thickness and land thickness must also be taken into consideration.
- Low viscosity adhesive can cause chips to slip after mounting. The adhesive must have a viscosity of 5000Pa · s (500ps) min. (at 25°C).
- Adhesive Coverage

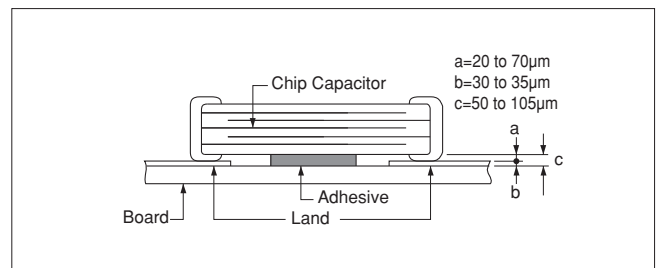

Part Number	Adhesive Coverage*
<b>GRM18, GQM18</b>	0.05mg min.
<b>GRM21, LLL21, GQM21</b>	0.1mg min.
<b>GRM31, LLL31</b>	0.15mg min.

\*Nominal Value

Continued on the following page. ↗

For General Purpose GRM Series

Capacitor Array GNM Series

Low ESL LLL Series

High-Q Type GJM Series

High Frequency GQM Series

Monolithic Microchip GMA Series

For Bonding GMD Series

Product Information Notice

## Notice

☞ Continued from the preceding page.

### 3. Adhesive Curing

1. Insufficient curing of the adhesive can cause chips to disconnect during flow soldering and deterioration in the insulation resistance between the outer electrodes due to moisture absorption.

Control curing temperature and time in order to prevent insufficient hardening.

### 4. Flux Application

1. An excessive amount of flux generates a large quantity of flux gas, which can cause a deterioration of solderability, so apply flux thinly and evenly throughout. (A foaming system is generally used for flow soldering.)
2. Flux containing too high a percentage of halide may cause corrosion of the outer electrodes unless there is sufficient cleaning. Use flux with a halide content of 0.2% max.

### 5. Flow Soldering

- Set temperature and time to ensure that leaching of the outer electrode does not exceed 25% of the chip end area as a single chip (full length of the edge A-B-C-D shown at right) and 25% of the length A-B shown as mounted on substrate.

3. Do not use strong acidic flux.

4. Do not use water-soluble \*flux.

(\*Water-soluble flux can be defined as non-rosin type flux including wash-type flux and non-wash-type flux.)

[As a Single Chip]

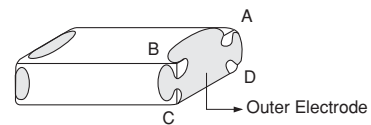

[As Mounted on Substrate]

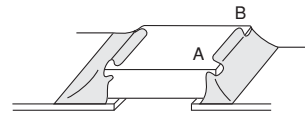

### 6. Washing

1. Please evaluate a capacitor using actual cleaning equipment and conditions to confirm the quality and select the applicable solvent.
2. Unsuitable cleaning solvent may leave residual flux or other foreign substances, causing deterioration of electrical characteristics and the reliability of the capacitors.

3. Select the proper cleaning conditions.

3-1. Improper cleaning conditions (excessive or insufficient) may result in the deterioration of the performance of the capacitors.

Continued on the following page. ☞

## Notice

☐ Continued from the preceding page.

### 7. Coating

1. A crack may be caused in the capacitor due to the stress of the thermal contraction of the resin during curing process.

The stress is affected by the amount of resin and curing contraction.

Select a resin with low curing contraction.

The difference in the thermal expansion coefficient between a coating resin or a molding resin and the capacitor may cause the destruction and deterioration of the capacitor such as a crack or peeling, and lead to the deterioration of insulation resistance or dielectric breakdown.

Select a resin for which the thermal expansion coefficient is as close to that of the capacitor as possible.  
A silicone resin can be used as an under-coating to buffer against the stress.

2. Select a resin that is less hygroscopic.  
Using hygroscopic resins under high humidity conditions may cause the deterioration of the insulation resistance of a capacitor.

An epoxy resin can be used as a less hygroscopic resin.

### 8. Die Bonding/Wire Bonding (GMA or GMD Series)

1. Die Bonding of Capacitors

• Use the following materials for the Brazing alloys:

Au-Sn (80/20) 300 to 320 °C in N<sub>2</sub> atmosphere

• Mounting

- (1) Control the temperature of the substrate so it matches the temperature of the brazing alloy.
- (2) Place the brazing alloy on the substrate and place the capacitor on the alloy. Hold the capacitor and gently apply the load. Be sure to complete the operation within 1 minute.

2. Wire Bonding

• Wire

Gold wire: 25 micro m (0.001 inch) diameter

• Bonding

- (1) Thermo compression, ultrasonic ball bonding.
- (2) Required stage temperature: 150 to 200 °C
- (3) Required wedge or capillary weight: 0.2N to 0.5N
- (4) Bond the capacitor and base substrate or other devices with gold wire.

### ■ Others

1. Transportation

1. The performance of a capacitor may be affected by the conditions during transportation.

1-1. The capacitors shall be protected against excessive temperature, humidity and mechanical force during transportation.

(1) Climatic condition

- low air temperature: -40°C
- change of temperature air/air: -25°C/+25°C
- low air pressure: 30 kPa
- change of air pressure: 6 kPa/min.

(2) Mechanical condition

Transportation shall be done in such a way that the boxes are not deformed and forces are not directly passed on to the inner packaging.

1-2. Do not apply excessive vibration, shock, and pressure to the capacitor.

- (1) When excessive mechanical shock or pressure is applied to a capacitor, chipping or cracking may occur in the ceramic body of the capacitor.
- (2) When the sharp edge of an air driver, a soldering iron, tweezers, a chassis, etc. impacts strongly on the surface of the capacitor, the capacitor may crack and short-circuit.

1-3. Do not use a capacitor to which excessive shock was applied by dropping, etc.

A capacitor dropped accidentally during processing may be damaged.

For General Purpose  
GRM Series

Capacitor Array  
GNM Series

Low ESL  
LLC Series

High-Q Type  
GJM Series

High Frequency  
GQM Series

Monolithic Microchip  
GMA Series

For Bonding  
GMD Series

Product Information  
Notice

# MEMO



# Contents

## Chip Monolithic Ceramic Capacitors (Medium Voltage)

### For General Purpose

#### GRM (250Vdc min.)/GRJ/GR3 Series

Temperature Compensating Type	
GRM Series (250Vdc min.)	p136
High Dielectric Constant Type	
GRM Series (250Vdc min.)	p143
Soft Termination Type GRJ Series	p148
Large Capacitance and High Allowable	
Ripple Current GR3 Series	p153

### Only for Applications

For LCD Backlight Inverter Circuit	
GRM/DC3.15kV Series	p158
For Information Devices GR4 Series	p161
For Camera Flash Circuit GR7 Series	p165

### AC250V Type (Which Meet Japanese Law)

GA2 Series	p169
------------	------

### Safety Standard Certified GA3 Series

UL, IEC60384-14 Class X1/Y2 Type GC	p173
IEC60384-14 Class Y2, X1/Y2 Type GF	p174
IEC60384-14 Class Y3 Type GD	p176
IEC60384-14 Class X2 Type GB	p177

Reference Data (Typical Example)	p182
----------------------------------	------

Package	p185
---------	------

⚠Caution/Notice	p188
-----------------	------

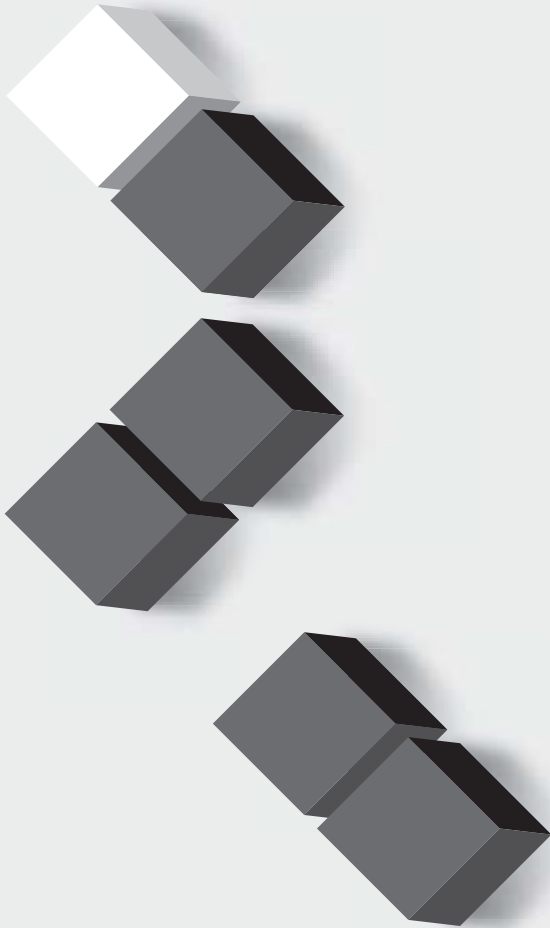

For General Purpose  
 GRM/GRJ/GR3 Series

Only for Applications

AC250V Type  
 GA2 Series

Safety Standard  
 Certified GA3 Series

Product Information

## Chip Monolithic Ceramic Capacitors (Medium Voltage)

# Temperature Compensating Type GRM Series (250Vdc min.)

### ■ Features

1. Low-loss and suitable for high frequency circuits
2. Murata's original internal electrode structure provides high flash-over voltage.
3. A new monolithic structure for small, surface-mountable devices capable of operating at high voltage levels
4. Sn-plated external electrodes provides good solderability.
5. Use the GRM21/31 type with flow or reflow soldering, and other types with reflow soldering only.

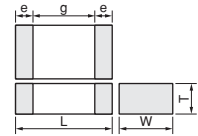

Part Number	Dimensions (mm)				
	L	W	T	e min.	g min.
GRM21A	2.0 ±0.2	1.25 ±0.2	1.0 +0.0, -0.3	0.3	1.5*
GRM21B			1.25 ±0.2		
GRM31A	3.2 ±0.2	1.6 ±0.2	1.0 +0.0, -0.3		
GRM31B			1.25 +0.0, -0.3		
GRM31C			1.6 ±0.2		
GRM32A	3.2 ±0.2	2.5 ±0.2	1.0 +0.0, -0.3		
GRM32B			1.25 +0.0, -0.3		
GRM32Q			1.5 +0.0, -0.3		
GRM32D			2.0 +0.0, -0.3		
GRM42A	4.5 ±0.3	2.0 ±0.2	1.0 +0.0, -0.3		
GRM43Q	4.5 ±0.4	3.2 ±0.3	1.5 +0.0, -0.3	2.2	
GRM43D	5.7 ±0.4	5.0 ±0.4	2.0 +0.0, -0.3	3.2	
GRM55Q			1.5 +0.0, -0.3		
GRM55D			2.0 +0.0, -0.3		

\* GRM31A7U3D, GRM32A7U3D, GRM32B7U3D: 1.8mm min.

### ■ Applications

Ideal for use on high frequency pulse circuits such as snubber circuits for switching power supplies, DC-DC converters, ballasts (inverter fluorescent lamps), etc.

Do not use these products in any Automotive Power train or Safety equipment including Battery chargers for Electric Vehicles and Plug-in Hybrids. Only Murata products clearly stipulated as "for Automotive use" can be used for automobile applications such as Power train and Safety equipment.

## C0G Characteristics

Part Number	Rated Voltage	TC Code (Standard)	Capacitance	Length L (mm)	Width W (mm)	Thickness T max. (mm)	Electrode g min.	Electrode e
GRM21A5C2E100JW01D	250Vdc	C0G (EIA)	10pF±5%	2	1.25	1	0.7mm	0.3mm min.
GRM21A5C2E120JW01D	250Vdc	C0G (EIA)	12pF±5%	2	1.25	1	0.7mm	0.3mm min.
GRM21A5C2E150JW01D	250Vdc	C0G (EIA)	15pF±5%	2	1.25	1	0.7mm	0.3mm min.
GRM21A5C2E180JW01D	250Vdc	C0G (EIA)	18pF±5%	2	1.25	1	0.7mm	0.3mm min.
GRM21A5C2E220JW01D	250Vdc	C0G (EIA)	22pF±5%	2	1.25	1	0.7mm	0.3mm min.
GRM21A5C2E270JW01D	250Vdc	C0G (EIA)	27pF±5%	2	1.25	1	0.7mm	0.3mm min.
GRM21A5C2E330JW01D	250Vdc	C0G (EIA)	33pF±5%	2	1.25	1	0.7mm	0.3mm min.
GRM21A5C2E390JW01D	250Vdc	C0G (EIA)	39pF±5%	2	1.25	1	0.7mm	0.3mm min.
GRM21A5C2E470JW01D	250Vdc	C0G (EIA)	47pF±5%	2	1.25	1	0.7mm	0.3mm min.
GRM21A5C2E560JW01D	250Vdc	C0G (EIA)	56pF±5%	2	1.25	1	0.7mm	0.3mm min.
GRM21A5C2E680JW01D	250Vdc	C0G (EIA)	68pF±5%	2	1.25	1	0.7mm	0.3mm min.
GRM21A5C2E820JW01D	250Vdc	C0G (EIA)	82pF±5%	2	1.25	1	0.7mm	0.3mm min.
GRM21A5C2E101JW01D	250Vdc	C0G (EIA)	100pF±5%	2	1.25	1	0.7mm	0.3mm min.
GRM21A5C2E121JW01D	250Vdc	C0G (EIA)	120pF±5%	2	1.25	1	0.7mm	0.3mm min.
GRM21A5C2E151JW01D	250Vdc	C0G (EIA)	150pF±5%	2	1.25	1	0.7mm	0.3mm min.
GRM21A5C2E181JW01D	250Vdc	C0G (EIA)	180pF±5%	2	1.25	1	0.7mm	0.3mm min.
GRM21A5C2E221JW01D	250Vdc	C0G (EIA)	220pF±5%	2	1.25	1	0.7mm	0.3mm min.
GRM21A5C2E271JW01D	250Vdc	C0G (EIA)	270pF±5%	2	1.25	1	0.7mm	0.3mm min.
GRM21A5C2E331JW01D	250Vdc	C0G (EIA)	330pF±5%	2	1.25	1	0.7mm	0.3mm min.
GRM31A5C2J100JW01D	630Vdc	C0G (EIA)	10pF±5%	3.2	1.6	1	1.5mm	0.3mm min.
GRM31A5C2J120JW01D	630Vdc	C0G (EIA)	12pF±5%	3.2	1.6	1	1.5mm	0.3mm min.
GRM31A5C2J150JW01D	630Vdc	C0G (EIA)	15pF±5%	3.2	1.6	1	1.5mm	0.3mm min.
GRM31A5C2J180JW01D	630Vdc	C0G (EIA)	18pF±5%	3.2	1.6	1	1.5mm	0.3mm min.

Continued on the following page. ↗

Continued from the preceding page.

Part Number	Rated Voltage	TC Code (Standard)	Capacitance	Length L (mm)	Width W (mm)	Thickness T max. (mm)	Electrode g min.	Electrode e
GRM31A5C2J220JW01D	630Vdc	C0G (EIA)	22pF±5%	3.2	1.6	1	1.5mm	0.3mm min.
GRM31A5C2J270JW01D	630Vdc	C0G (EIA)	27pF±5%	3.2	1.6	1	1.5mm	0.3mm min.
GRM31A5C2J330JW01D	630Vdc	C0G (EIA)	33pF±5%	3.2	1.6	1	1.5mm	0.3mm min.
GRM31A5C2J390JW01D	630Vdc	C0G (EIA)	39pF±5%	3.2	1.6	1	1.5mm	0.3mm min.
GRM31A5C2J470JW01D	630Vdc	C0G (EIA)	47pF±5%	3.2	1.6	1	1.5mm	0.3mm min.
GRM31A5C2J560JW01D	630Vdc	C0G (EIA)	56pF±5%	3.2	1.6	1	1.5mm	0.3mm min.
GRM31A5C2J680JW01D	630Vdc	C0G (EIA)	68pF±5%	3.2	1.6	1	1.5mm	0.3mm min.
GRM31A5C2J820JW01D	630Vdc	C0G (EIA)	82pF±5%	3.2	1.6	1	1.5mm	0.3mm min.
GRM31A5C2J101JW01D	630Vdc	C0G (EIA)	100pF±5%	3.2	1.6	1	1.5mm	0.3mm min.
GRM31A5C2J121JW01D	630Vdc	C0G (EIA)	120pF±5%	3.2	1.6	1	1.5mm	0.3mm min.
GRM31A5C2J151JW01D	630Vdc	C0G (EIA)	150pF±5%	3.2	1.6	1	1.5mm	0.3mm min.
GRM31A5C2J181JW01D	630Vdc	C0G (EIA)	180pF±5%	3.2	1.6	1	1.5mm	0.3mm min.
GRM31A5C2J221JW01D	630Vdc	C0G (EIA)	220pF±5%	3.2	1.6	1	1.5mm	0.3mm min.
GRM31A5C2J271JW01D	630Vdc	C0G (EIA)	270pF±5%	3.2	1.6	1	1.5mm	0.3mm min.
GRM31A5C2J331JW01D	630Vdc	C0G (EIA)	330pF±5%	3.2	1.6	1	1.5mm	0.3mm min.
GRM31A5C2J391JW01D	630Vdc	C0G (EIA)	390pF±5%	3.2	1.6	1	1.5mm	0.3mm min.
GRM31A5C2J471JW01D	630Vdc	C0G (EIA)	470pF±5%	3.2	1.6	1	1.5mm	0.3mm min.
GRM31A5C2J561JW01D	630Vdc	C0G (EIA)	560pF±5%	3.2	1.6	1	1.5mm	0.3mm min.
GRM31B5C2J681JW01L	630Vdc	C0G (EIA)	680pF±5%	3.2	1.6	1.25	1.5mm	0.3mm min.
GRM31B5C2J821JW01L	630Vdc	C0G (EIA)	820pF±5%	3.2	1.6	1.25	1.5mm	0.3mm min.
GRM31B5C2J102JW01L	630Vdc	C0G (EIA)	1000pF±5%	3.2	1.6	1.25	1.5mm	0.3mm min.
GRM31A5C3A100JW01D	1000Vdc	C0G (EIA)	10pF±5%	3.2	1.6	1	1.5mm	0.3mm min.
GRM31A5C3A120JW01D	1000Vdc	C0G (EIA)	12pF±5%	3.2	1.6	1	1.5mm	0.3mm min.
GRM31A5C3A150JW01D	1000Vdc	C0G (EIA)	15pF±5%	3.2	1.6	1	1.5mm	0.3mm min.
GRM31A5C3A180JW01D	1000Vdc	C0G (EIA)	18pF±5%	3.2	1.6	1	1.5mm	0.3mm min.
GRM31A5C3A220JW01D	1000Vdc	C0G (EIA)	22pF±5%	3.2	1.6	1	1.5mm	0.3mm min.
GRM31A5C3A270JW01D	1000Vdc	C0G (EIA)	27pF±5%	3.2	1.6	1	1.5mm	0.3mm min.
GRM31A5C3A330JW01D	1000Vdc	C0G (EIA)	33pF±5%	3.2	1.6	1	1.5mm	0.3mm min.
GRM31A5C3A390JW01D	1000Vdc	C0G (EIA)	39pF±5%	3.2	1.6	1	1.5mm	0.3mm min.
GRM31A5C3A470JW01D	1000Vdc	C0G (EIA)	47pF±5%	3.2	1.6	1	1.5mm	0.3mm min.
GRM31A5C3A560JW01D	1000Vdc	C0G (EIA)	56pF±5%	3.2	1.6	1	1.5mm	0.3mm min.
GRM31A5C3A680JW01D	1000Vdc	C0G (EIA)	68pF±5%	3.2	1.6	1	1.5mm	0.3mm min.
GRM31A5C3A820JW01D	1000Vdc	C0G (EIA)	82pF±5%	3.2	1.6	1	1.5mm	0.3mm min.
GRM31A5C3A101JW01D	1000Vdc	C0G (EIA)	100pF±5%	3.2	1.6	1	1.5mm	0.3mm min.
GRM31A5C3A121JW01D	1000Vdc	C0G (EIA)	120pF±5%	3.2	1.6	1	1.5mm	0.3mm min.
GRM31A5C3A151JW01D	1000Vdc	C0G (EIA)	150pF±5%	3.2	1.6	1	1.5mm	0.3mm min.
GRM31A5C3A181JW01D	1000Vdc	C0G (EIA)	180pF±5%	3.2	1.6	1	1.5mm	0.3mm min.
GRM31A5C3A221JW01D	1000Vdc	C0G (EIA)	220pF±5%	3.2	1.6	1	1.5mm	0.3mm min.

## U2J Characteristics

Part Number	Rated Voltage	TC Code (Standard)	Capacitance	Length L (mm)	Width W (mm)	Thickness T max. (mm)	Electrode g min.	Electrode e
GRM21A7U2E101JW31D	250Vdc	U2J (EIA)	100pF±5%	2	1.25	1	0.7mm	0.3mm min.
GRM21A7U2E121JW31D	250Vdc	U2J (EIA)	120pF±5%	2	1.25	1	0.7mm	0.3mm min.
GRM21A7U2E151JW31D	250Vdc	U2J (EIA)	150pF±5%	2	1.25	1	0.7mm	0.3mm min.
GRM21A7U2E181JW31D	250Vdc	U2J (EIA)	180pF±5%	2	1.25	1	0.7mm	0.3mm min.
GRM21A7U2E221JW31D	250Vdc	U2J (EIA)	220pF±5%	2	1.25	1	0.7mm	0.3mm min.
GRM21A7U2E271JW31D	250Vdc	U2J (EIA)	270pF±5%	2	1.25	1	0.7mm	0.3mm min.
GRM21A7U2E331JW31D	250Vdc	U2J (EIA)	330pF±5%	2	1.25	1	0.7mm	0.3mm min.
GRM21A7U2E391JW31D	250Vdc	U2J (EIA)	390pF±5%	2	1.25	1	0.7mm	0.3mm min.
GRM21A7U2E471JW31D	250Vdc	U2J (EIA)	470pF±5%	2	1.25	1	0.7mm	0.3mm min.
GRM21A7U2E561JW31D	250Vdc	U2J (EIA)	560pF±5%	2	1.25	1	0.7mm	0.3mm min.
GRM21A7U2E681JW31D	250Vdc	U2J (EIA)	680pF±5%	2	1.25	1	0.7mm	0.3mm min.
GRM21A7U2E821JW31D	250Vdc	U2J (EIA)	820pF±5%	2	1.25	1	0.7mm	0.3mm min.
GRM21A7U2E102JW31D	250Vdc	U2J (EIA)	1000pF±5%	2	1.25	1	0.7mm	0.3mm min.

Continued on the following page. ↗

Continued from the preceding page.

Part Number	Rated Voltage	TC Code (Standard)	Capacitance	Length L (mm)	Width W (mm)	Thickness T max. (mm)	Electrode g min.	Electrode e
GRM21A7U2E122JW31D	250Vdc	U2J (EIA)	1200pF±5%	2	1.25	1	0.7mm	0.3mm min.
GRM21A7U2E152JW31D	250Vdc	U2J (EIA)	1500pF±5%	2	1.25	1	0.7mm	0.3mm min.
GRM21A7U2E182JW31D	250Vdc	U2J (EIA)	1800pF±5%	2	1.25	1	0.7mm	0.3mm min.
GRM21A7U2E222JW31D	250Vdc	U2J (EIA)	2200pF±5%	2	1.25	1	0.7mm	0.3mm min.
GRM21B7U2E272JW32L	250Vdc	U2J (EIA)	2700pF±5%	2	1.25	1.45	0.7mm	0.3mm min.
GRM31A7U2E272JW31D	250Vdc	U2J (EIA)	2700pF±5%	3.2	1.6	1	1.5mm	0.3mm min.
GRM21B7U2E332JW32L	250Vdc	U2J (EIA)	3300pF±5%	2	1.25	1.45	0.7mm	0.3mm min.
GRM31A7U2E332JW31D	250Vdc	U2J (EIA)	3300pF±5%	3.2	1.6	1	1.5mm	0.3mm min.
GRM21B7U2E392JW32L	250Vdc	U2J (EIA)	3900pF±5%	2	1.25	1.45	0.7mm	0.3mm min.
GRM31A7U2E392JW31D	250Vdc	U2J (EIA)	3900pF±5%	3.2	1.6	1	1.5mm	0.3mm min.
GRM21B7U2E472JW32L	250Vdc	U2J (EIA)	4700pF±5%	2	1.25	1.45	0.7mm	0.3mm min.
GRM31A7U2E472JW31D	250Vdc	U2J (EIA)	4700pF±5%	3.2	1.6	1	1.5mm	0.3mm min.
GRM21B7U2E562JW32L	250Vdc	U2J (EIA)	5600pF±5%	2	1.25	1.45	0.7mm	0.3mm min.
GRM31A7U2E562JW31D	250Vdc	U2J (EIA)	5600pF±5%	3.2	1.6	1	1.5mm	0.3mm min.
GRM31B7U2E682JW31L	250Vdc	U2J (EIA)	6800pF±5%	3.2	1.6	1.25	1.5mm	0.3mm min.
GRM31B7U2E822JW31L	250Vdc	U2J (EIA)	8200pF±5%	3.2	1.6	1.25	1.5mm	0.3mm min.
GRM31B7U2E103JW31L	250Vdc	U2J (EIA)	10000pF±5%	3.2	1.6	1.25	1.5mm	0.3mm min.
GRM31A7U2J100JW31D	630Vdc	U2J (EIA)	10pF±5%	3.2	1.6	1	1.5mm	0.3mm min.
GRM31A7U2J120JW31D	630Vdc	U2J (EIA)	12pF±5%	3.2	1.6	1	1.5mm	0.3mm min.
GRM31A7U2J150JW31D	630Vdc	U2J (EIA)	15pF±5%	3.2	1.6	1	1.5mm	0.3mm min.
GRM31A7U2J180JW31D	630Vdc	U2J (EIA)	18pF±5%	3.2	1.6	1	1.5mm	0.3mm min.
GRM31A7U2J220JW31D	630Vdc	U2J (EIA)	22pF±5%	3.2	1.6	1	1.5mm	0.3mm min.
GRM31A7U2J270JW31D	630Vdc	U2J (EIA)	27pF±5%	3.2	1.6	1	1.5mm	0.3mm min.
GRM31A7U2J330JW31D	630Vdc	U2J (EIA)	33pF±5%	3.2	1.6	1	1.5mm	0.3mm min.
GRM31A7U2J390JW31D	630Vdc	U2J (EIA)	39pF±5%	3.2	1.6	1	1.5mm	0.3mm min.
GRM31A7U2J470JW31D	630Vdc	U2J (EIA)	47pF±5%	3.2	1.6	1	1.5mm	0.3mm min.
GRM31A7U2J560JW31D	630Vdc	U2J (EIA)	56pF±5%	3.2	1.6	1	1.5mm	0.3mm min.
GRM31A7U2J680JW31D	630Vdc	U2J (EIA)	68pF±5%	3.2	1.6	1	1.5mm	0.3mm min.
GRM31A7U2J820JW31D	630Vdc	U2J (EIA)	82pF±5%	3.2	1.6	1	1.5mm	0.3mm min.
GRM31A7U2J101JW31D	630Vdc	U2J (EIA)	100pF±5%	3.2	1.6	1	1.5mm	0.3mm min.
GRM31A7U2J121JW31D	630Vdc	U2J (EIA)	120pF±5%	3.2	1.6	1	1.5mm	0.3mm min.
GRM31A7U2J151JW31D	630Vdc	U2J (EIA)	150pF±5%	3.2	1.6	1	1.5mm	0.3mm min.
GRM31A7U2J181JW31D	630Vdc	U2J (EIA)	180pF±5%	3.2	1.6	1	1.5mm	0.3mm min.
GRM31A7U2J221JW31D	630Vdc	U2J (EIA)	220pF±5%	3.2	1.6	1	1.5mm	0.3mm min.
GRM31A7U2J271JW31D	630Vdc	U2J (EIA)	270pF±5%	3.2	1.6	1	1.5mm	0.3mm min.
GRM31A7U2J331JW31D	630Vdc	U2J (EIA)	330pF±5%	3.2	1.6	1	1.5mm	0.3mm min.
GRM31A7U2J391JW31D	630Vdc	U2J (EIA)	390pF±5%	3.2	1.6	1	1.5mm	0.3mm min.
GRM31A7U2J471JW31D	630Vdc	U2J (EIA)	470pF±5%	3.2	1.6	1	1.5mm	0.3mm min.
GRM31A7U2J561JW31D	630Vdc	U2J (EIA)	560pF±5%	3.2	1.6	1	1.5mm	0.3mm min.
GRM31A7U2J681JW31D	630Vdc	U2J (EIA)	680pF±5%	3.2	1.6	1	1.5mm	0.3mm min.
GRM31A7U2J821JW31D	630Vdc	U2J (EIA)	820pF±5%	3.2	1.6	1	1.5mm	0.3mm min.
GRM31A7U2J102JW31D	630Vdc	U2J (EIA)	1000pF±5%	3.2	1.6	1	1.5mm	0.3mm min.
GRM31A7U2J122JW31D	630Vdc	U2J (EIA)	1200pF±5%	3.2	1.6	1	1.5mm	0.3mm min.
GRM32A7U2J122JW31D	630Vdc	U2J (EIA)	1200pF±5%	3.2	2.5	1	1.5mm	0.3mm min.
GRM31A7U2J152JW31D	630Vdc	U2J (EIA)	1500pF±5%	3.2	1.6	1	1.5mm	0.3mm min.
GRM32A7U2J152JW31D	630Vdc	U2J (EIA)	1500pF±5%	3.2	2.5	1	1.5mm	0.3mm min.
GRM31A7U2J182JW31D	630Vdc	U2J (EIA)	1800pF±5%	3.2	1.6	1	1.5mm	0.3mm min.
GRM32A7U2J182JW31D	630Vdc	U2J (EIA)	1800pF±5%	3.2	2.5	1	1.5mm	0.3mm min.
GRM31A7U2J222JW31D	630Vdc	U2J (EIA)	2200pF±5%	3.2	1.6	1	1.5mm	0.3mm min.
GRM32A7U2J222JW31D	630Vdc	U2J (EIA)	2200pF±5%	3.2	2.5	1	1.5mm	0.3mm min.
GRM31B7U2J272JW31L	630Vdc	U2J (EIA)	2700pF±5%	3.2	1.6	1.25	1.5mm	0.3mm min.
GRM31B7U2J332JW31L	630Vdc	U2J (EIA)	3300pF±5%	3.2	1.6	1.25	1.5mm	0.3mm min.
GRM31C7U2J392JW32L	630Vdc	U2J (EIA)	3900pF±5%	3.2	1.6	1.8	1.5mm	0.3mm min.
GRM31C7U2J472JW32L	630Vdc	U2J (EIA)	4700pF±5%	3.2	1.6	1.8	1.5mm	0.3mm min.
GRM32B7U2J562JW31L	630Vdc	U2J (EIA)	5600pF±5%	3.2	2.5	1.25	1.5mm	0.3mm min.
GRM32Q7U2J682JW31L	630Vdc	U2J (EIA)	6800pF±5%	3.2	2.5	1.5	1.5mm	0.3mm min.
GRM32D7U2J822JW31L	630Vdc	U2J (EIA)	8200pF±5%	3.2	2.5	2	1.5mm	0.3mm min.

Continued on the following page. ↗

For General Purpose GRM/GRU/GR3 Series  
 Only for Applications  
 AC250V Type GA2 Series  
 Safety Standard Certified GA3 Series  
 Product Information



Continued from the preceding page.

Part Number	Rated Voltage	TC Code (Standard)	Capacitance	Length L (mm)	Width W (mm)	Thickness T max. (mm)	Electrode g min.	Electrode e
GRM32D7U2J103JW31L	630Vdc	U2J (EIA)	1000pF±5%	3.2	2.5	2	1.5mm	0.3mm min.
GRM43Q7U2J123JW31L	630Vdc	U2J (EIA)	1200pF±5%	4.5	3.2	1.5	2.2mm	0.3mm min.
GRM43D7U2J153JW31L	630Vdc	U2J (EIA)	1500pF±5%	4.5	3.2	2	2.2mm	0.3mm min.
GRM43D7U2J183JW31L	630Vdc	U2J (EIA)	1800pF±5%	4.5	3.2	2	2.2mm	0.3mm min.
GRM43D7U2J223JW31L	630Vdc	U2J (EIA)	2200pF±5%	4.5	3.2	2	2.2mm	0.3mm min.
GRM55Q7U2J273JW31L	630Vdc	U2J (EIA)	2700pF±5%	5.7	5.0	1.5	3.2mm	0.3mm min.
GRM55D7U2J333JW31L	630Vdc	U2J (EIA)	3300pF±5%	5.7	5.0	2	3.2mm	0.3mm min.
GRM55D7U2J393JW31L	630Vdc	U2J (EIA)	3900pF±5%	5.7	5.0	2	3.2mm	0.3mm min.
GRM55D7U2J473JW31L	630Vdc	U2J (EIA)	4700pF±5%	5.7	5.0	2	3.2mm	0.3mm min.
GRM31A7U3A100JW31D	1000Vdc	U2J (EIA)	10pF±5%	3.2	1.6	1	1.5mm	0.3mm min.
GRM31A7U3A120JW31D	1000Vdc	U2J (EIA)	12pF±5%	3.2	1.6	1	1.5mm	0.3mm min.
GRM31A7U3A150JW31D	1000Vdc	U2J (EIA)	15pF±5%	3.2	1.6	1	1.5mm	0.3mm min.
GRM31A7U3A180JW31D	1000Vdc	U2J (EIA)	18pF±5%	3.2	1.6	1	1.5mm	0.3mm min.
GRM31A7U3A220JW31D	1000Vdc	U2J (EIA)	22pF±5%	3.2	1.6	1	1.5mm	0.3mm min.
GRM31A7U3A270JW31D	1000Vdc	U2J (EIA)	27pF±5%	3.2	1.6	1	1.5mm	0.3mm min.
GRM31A7U3A330JW31D	1000Vdc	U2J (EIA)	33pF±5%	3.2	1.6	1	1.5mm	0.3mm min.
GRM31A7U3A390JW31D	1000Vdc	U2J (EIA)	39pF±5%	3.2	1.6	1	1.5mm	0.3mm min.
GRM31A7U3A470JW31D	1000Vdc	U2J (EIA)	47pF±5%	3.2	1.6	1	1.5mm	0.3mm min.
GRM31A7U3A560JW31D	1000Vdc	U2J (EIA)	56pF±5%	3.2	1.6	1	1.5mm	0.3mm min.
GRM31A7U3A680JW31D	1000Vdc	U2J (EIA)	68pF±5%	3.2	1.6	1	1.5mm	0.3mm min.
GRM31A7U3A820JW31D	1000Vdc	U2J (EIA)	82pF±5%	3.2	1.6	1	1.5mm	0.3mm min.
GRM31A7U3A101JW31D	1000Vdc	U2J (EIA)	100pF±5%	3.2	1.6	1	1.5mm	0.3mm min.
GRM31A7U3A121JW31D	1000Vdc	U2J (EIA)	120pF±5%	3.2	1.6	1	1.5mm	0.3mm min.
GRM31A7U3A151JW31D	1000Vdc	U2J (EIA)	150pF±5%	3.2	1.6	1	1.5mm	0.3mm min.
GRM31A7U3A181JW31D	1000Vdc	U2J (EIA)	180pF±5%	3.2	1.6	1	1.5mm	0.3mm min.
GRM31A7U3A221JW31D	1000Vdc	U2J (EIA)	220pF±5%	3.2	1.6	1	1.5mm	0.3mm min.
GRM31A7U3A271JW31D	1000Vdc	U2J (EIA)	270pF±5%	3.2	1.6	1	1.5mm	0.3mm min.
GRM31A7U3A331JW31D	1000Vdc	U2J (EIA)	330pF±5%	3.2	1.6	1	1.5mm	0.3mm min.
GRM31B7U3A391JW31L	1000Vdc	U2J (EIA)	390pF±5%	3.2	1.6	1.25	1.5mm	0.3mm min.
GRM31B7U3A471JW31L	1000Vdc	U2J (EIA)	470pF±5%	3.2	1.6	1.25	1.5mm	0.3mm min.
GRM31B7U3A561JW31L	1000Vdc	U2J (EIA)	560pF±5%	3.2	1.6	1.25	1.5mm	0.3mm min.
GRM31B7U3A681JW31L	1000Vdc	U2J (EIA)	680pF±5%	3.2	1.6	1.25	1.5mm	0.3mm min.
GRM31C7U3A821JW32L	1000Vdc	U2J (EIA)	820pF±5%	3.2	1.6	1.8	1.5mm	0.3mm min.
GRM31C7U3A102JW32L	1000Vdc	U2J (EIA)	1000pF±5%	3.2	1.6	1.8	1.5mm	0.3mm min.
GRM32B7U3A122JW31L	1000Vdc	U2J (EIA)	1200pF±5%	3.2	2.5	1.25	1.5mm	0.3mm min.
GRM32Q7U3A152JW31L	1000Vdc	U2J (EIA)	1500pF±5%	3.2	2.5	1.5	1.5mm	0.3mm min.
GRM32D7U3A182JW31L	1000Vdc	U2J (EIA)	1800pF±5%	3.2	2.5	2	1.5mm	0.3mm min.
GRM32D7U3A222JW31L	1000Vdc	U2J (EIA)	2200pF±5%	3.2	2.5	2	1.5mm	0.3mm min.
GRM43Q7U3A272JW31L	1000Vdc	U2J (EIA)	2700pF±5%	4.5	3.2	1.5	2.2mm	0.3mm min.
GRM43Q7U3A332JW31L	1000Vdc	U2J (EIA)	3300pF±5%	4.5	3.2	1.5	2.2mm	0.3mm min.
GRM43D7U3A392JW31L	1000Vdc	U2J (EIA)	3900pF±5%	4.5	3.2	2	2.2mm	0.3mm min.
GRM43D7U3A472JW31L	1000Vdc	U2J (EIA)	4700pF±5%	4.5	3.2	2	2.2mm	0.3mm min.
GRM55Q7U3A562JW31L	1000Vdc	U2J (EIA)	5600pF±5%	5.7	5.0	1.5	3.2mm	0.3mm min.
GRM55Q7U3A682JW31L	1000Vdc	U2J (EIA)	6800pF±5%	5.7	5.0	1.5	3.2mm	0.3mm min.
GRM55D7U3A822JW31L	1000Vdc	U2J (EIA)	8200pF±5%	5.7	5.0	2	3.2mm	0.3mm min.
GRM55D7U3A103JW31L	1000Vdc	U2J (EIA)	10000pF±5%	5.7	5.0	2	3.2mm	0.3mm min.
GRM31A7U3D100JW31D	2000Vdc	U2J (EIA)	10pF±5%	3.2	1.6	1	1.8mm	0.3mm min.
GRM31A7U3D120JW31D	2000Vdc	U2J (EIA)	12pF±5%	3.2	1.6	1	1.8mm	0.3mm min.
GRM31A7U3D150JW31D	2000Vdc	U2J (EIA)	15pF±5%	3.2	1.6	1	1.8mm	0.3mm min.
GRM31A7U3D180JW31D	2000Vdc	U2J (EIA)	18pF±5%	3.2	1.6	1	1.8mm	0.3mm min.
GRM31A7U3D220JW31D	2000Vdc	U2J (EIA)	22pF±5%	3.2	1.6	1	1.8mm	0.3mm min.
GRM31A7U3D270JW31D	2000Vdc	U2J (EIA)	27pF±5%	3.2	1.6	1	1.8mm	0.3mm min.
GRM31A7U3D330JW31D	2000Vdc	U2J (EIA)	33pF±5%	3.2	1.6	1	1.8mm	0.3mm min.
GRM31A7U3D390JW31D	2000Vdc	U2J (EIA)	39pF±5%	3.2	1.6	1	1.8mm	0.3mm min.
GRM31A7U3D470JW31D	2000Vdc	U2J (EIA)	47pF±5%	3.2	1.6	1	1.8mm	0.3mm min.
GRM31A7U3D560JW31D	2000Vdc	U2J (EIA)	56pF±5%	3.2	1.6	1	1.8mm	0.3mm min.
GRM31A7U3D680JW31D	2000Vdc	U2J (EIA)	68pF±5%	3.2	1.6	1	1.8mm	0.3mm min.

For General Purpose  
GRM/GRJ/GR3 Series

Only for Applications

AC250V Type  
GA2 Series

Safety Standard  
Certified GA3 Series

Product Information

Continued on the following page. ↗

Continued from the preceding page.

Part Number	Rated Voltage	TC Code (Standard)	Capacitance	Length L (mm)	Width W (mm)	Thickness T max. (mm)	Electrode g min.	Electrode e
GRM32A7U3D820JW31D	2000Vdc	U2J (EIA)	82pF±5%	3.2	2.5	1	1.8mm	0.3mm min.
GRM32A7U3D101JW31D	2000Vdc	U2J (EIA)	100pF±5%	3.2	2.5	1	1.8mm	0.3mm min.
GRM32A7U3D121JW31D	2000Vdc	U2J (EIA)	120pF±5%	3.2	2.5	1	1.8mm	0.3mm min.
GRM32A7U3D151JW31D	2000Vdc	U2J (EIA)	150pF±5%	3.2	2.5	1	1.8mm	0.3mm min.
GRM32B7U3D181JW31L	2000Vdc	U2J (EIA)	180pF±5%	3.2	2.5	1.25	1.8mm	0.3mm min.
GRM32B7U3D221JW31L	2000Vdc	U2J (EIA)	220pF±5%	3.2	2.5	1.25	1.8mm	0.3mm min.
GRM42A7U3F270JW31L	3150Vdc	U2J (EIA)	27pF±5%	4.5	2.0	1	2.9mm	0.3mm min.
GRM42A7U3F330JW31L	3150Vdc	U2J (EIA)	33pF±5%	4.5	2.0	1	2.9mm	0.3mm min.
GRM42A7U3F390JW31L	3150Vdc	U2J (EIA)	39pF±5%	4.5	2.0	1	2.9mm	0.3mm min.
GRM42A7U3F470JW31L	3150Vdc	U2J (EIA)	47pF±5%	4.5	2.0	1	2.9mm	0.3mm min.
GRM42A7U3F560JW31L	3150Vdc	U2J (EIA)	56pF±5%	4.5	2.0	1	2.9mm	0.3mm min.
GRM42A7U3F680JW31L	3150Vdc	U2J (EIA)	68pF±5%	4.5	2.0	1	2.9mm	0.3mm min.
GRM42A7U3F820JW31L	3150Vdc	U2J (EIA)	82pF±5%	4.5	2.0	1	2.9mm	0.3mm min.
GRM42A7U3F101JW31L	3150Vdc	U2J (EIA)	100pF±5%	4.5	2.0	1	2.9mm	0.3mm min.

For General Purpose GRM/GRU/GR3 Series

Only for Applications

AC250V Type GA2 Series

Safety Standard Certified GA3 Series

Product Information

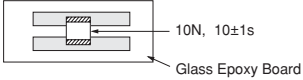
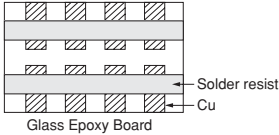

## GRM Series Specifications and Test Methods

No.	Item	Specifications	Test Method												
1	Operating Temperature Range	-55 to +125°C	-												
2	Appearance	No defects or abnormalities	Visual inspection												
3	Dimensions	Within the specified dimension	Using calipers and micrometers												
4	Dielectric Strength	No defects or abnormalities	<p>No failure should be observed when voltage in the Table is applied between the terminations for 1 to 5 sec., provided the charge/discharge current is less than 50mA.</p> <table border="1" style="width: 100%; border-collapse: collapse; margin-top: 10px;"> <thead> <tr style="background-color: #f2f2f2;"> <th>Rated Voltage</th> <th>Test Voltage</th> </tr> </thead> <tbody> <tr> <td>DC250V</td> <td>200% of the rated voltage</td> </tr> <tr> <td>DC630V</td> <td>150% of the rated voltage</td> </tr> <tr> <td>DC1kV, DC2kV, DC3.15kV</td> <td>130% of the rated voltage</td> </tr> </tbody> </table>	Rated Voltage	Test Voltage	DC250V	200% of the rated voltage	DC630V	150% of the rated voltage	DC1kV, DC2kV, DC3.15kV	130% of the rated voltage				
Rated Voltage	Test Voltage														
DC250V	200% of the rated voltage														
DC630V	150% of the rated voltage														
DC1kV, DC2kV, DC3.15kV	130% of the rated voltage														
5	Insulation Resistance (I.R.)	More than 10,000MΩ	The insulation resistance should be measured with DC500±50V (DC250±25V in case of rated voltage: DC250V) and within 60±5 sec. of charging.												
6	Capacitance	Within the specified tolerance	The capacitance/Q should be measured at the frequency and voltage shown as follows.												
7	Q	1,000 min.	<table border="1" style="width: 100%; border-collapse: collapse; margin-top: 10px;"> <thead> <tr style="background-color: #f2f2f2;"> <th>Capacitance</th> <th>Frequency</th> <th>Voltage</th> </tr> </thead> <tbody> <tr> <td>C&lt;1,000pF</td> <td>1±0.2MHz</td> <td>AC0.5 to 5V(r.m.s.)</td> </tr> <tr> <td>C≥1,000pF</td> <td>1±0.2kHz</td> <td>AC1±0.2V(r.m.s.)</td> </tr> </tbody> </table>	Capacitance	Frequency	Voltage	C<1,000pF	1±0.2MHz	AC0.5 to 5V(r.m.s.)	C≥1,000pF	1±0.2kHz	AC1±0.2V(r.m.s.)			
Capacitance	Frequency	Voltage													
C<1,000pF	1±0.2MHz	AC0.5 to 5V(r.m.s.)													
C≥1,000pF	1±0.2kHz	AC1±0.2V(r.m.s.)													
8	Capacitance Temperature Characteristics	Temp. Coefficient C0G char. : 0±30ppm/°C (Temp. Range : +25 to +125°C) 0+30, -72ppm/°C (Temp. Range : -55 to +25°C) U2J char. : -750±120ppm/°C (Temp. Range : +25 to +125°C) -750+120, -347ppm/°C (Temp. Range : -55 to +25°C)	<p>The capacitance measurement should be made at each step specified in the Table.</p> <table border="1" style="width: 100%; border-collapse: collapse; margin-top: 10px;"> <thead> <tr style="background-color: #f2f2f2;"> <th>Step</th> <th>Temperature (°C)</th> </tr> </thead> <tbody> <tr> <td>1</td> <td>25±2</td> </tr> <tr> <td>2</td> <td>Min. Operating Temp.±3</td> </tr> <tr> <td>3</td> <td>25±2</td> </tr> <tr> <td>4</td> <td>Max. Operating Temp.±2</td> </tr> <tr> <td>5</td> <td>25±2</td> </tr> </tbody> </table>	Step	Temperature (°C)	1	25±2	2	Min. Operating Temp.±3	3	25±2	4	Max. Operating Temp.±2	5	25±2
Step	Temperature (°C)														
1	25±2														
2	Min. Operating Temp.±3														
3	25±2														
4	Max. Operating Temp.±2														
5	25±2														
9	Adhesive Strength of Termination	No removal of the terminations or other defect should occur.	<p>Solder the capacitor to the testing jig (glass epoxy board) shown in Fig. 1.</p> <p>Then apply 10N force in the direction of the arrow.</p> <p>The soldering should be done using the reflow method and should be conducted with care so that the soldering is uniform and free of defects such as heat shock.</p> <div style="text-align: center; margin-top: 10px;">  <p>10N, 10±1s Glass Epoxy Board</p> </div> <p style="text-align: center;">Fig. 1</p>												
10	Appearance	No defects or abnormalities	<p>Solder the capacitor to the test jig (glass epoxy board).</p> <p>The capacitor should be subjected to a simple harmonic motion having a total amplitude of 1.5mm, the frequency being varied uniformly between the approximate limits of 10 and 55Hz. The frequency range, from 10 to 55Hz and return to 10Hz, should be traversed in approximately 1 min. This motion should be applied for a period of 2 hrs. in each of 3 mutually perpendicular directions (total of 6 hrs.).</p> <div style="text-align: center; margin-top: 10px;">  <p>Solder resist Cu Glass Epoxy Board</p> </div>												
	Capacitance	Within the specified tolerance													
	Q	1,000 min.													

Continued on the following page.

For General Purpose GRM/GRJ/GR3 Series

Only for Applications

AC250V Type GA2 Series

Safety Standard Certified GA3 Series

Product Information

# GRM Series Specifications and Test Methods

Continued from the preceding page.

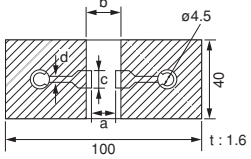
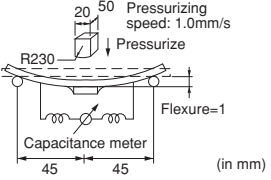
No.	Item	Specifications	Test Method																															
11	Deflection	No marking defects	Solder the capacitor to the testing jig (glass epoxy board) shown in Fig. 2. Then apply a force in the direction shown in Fig. 3. The soldering should be done using the reflow method and should be conducted with care so that the soldering is uniform and free of defects such as heat shock.																															
		 <p>Fig. 2</p> <table border="1"> <thead> <tr> <th rowspan="2">L×W (mm)</th> <th colspan="4">Dimension (mm)</th> </tr> <tr> <th>a</th> <th>b</th> <th>c</th> <th>d</th> </tr> </thead> <tbody> <tr> <td>2.0×1.25</td> <td>1.2</td> <td>4.0</td> <td>1.65</td> <td rowspan="6">1.0</td> </tr> <tr> <td>3.2×1.6</td> <td>2.2</td> <td>5.0</td> <td>2.0</td> </tr> <tr> <td>3.2×2.5</td> <td>2.2</td> <td>5.0</td> <td>2.9</td> </tr> <tr> <td>4.5×2.0</td> <td>3.5</td> <td>7.0</td> <td>2.4</td> </tr> <tr> <td>4.5×3.2</td> <td>3.5</td> <td>7.0</td> <td>3.7</td> </tr> <tr> <td>5.7×5.0</td> <td>4.5</td> <td>8.0</td> <td>5.6</td> </tr> </tbody> </table>		L×W (mm)	Dimension (mm)				a	b	c	d	2.0×1.25	1.2	4.0	1.65	1.0	3.2×1.6	2.2	5.0	2.0	3.2×2.5	2.2	5.0	2.9	4.5×2.0	3.5	7.0	2.4	4.5×3.2	3.5	7.0	3.7	5.7×5.0
L×W (mm)	Dimension (mm)																																	
	a	b	c	d																														
2.0×1.25	1.2	4.0	1.65	1.0																														
3.2×1.6	2.2	5.0	2.0																															
3.2×2.5	2.2	5.0	2.9																															
4.5×2.0	3.5	7.0	2.4																															
4.5×3.2	3.5	7.0	3.7																															
5.7×5.0	4.5	8.0	5.6																															
			 <p>Fig. 3</p>																															
12	Solderability of Termination	75% of the terminations are to be soldered evenly and continuously.	Immerse the capacitor in a solution of ethanol (JIS-K-8101) and rosin (JIS-K-5902) (25% rosin in weight proportion). Immerse in solder solution for 2±0.5 sec. Immersing speed: 25±2.5mm/s Temp. of solder: 245±5°C Lead Free Solder (Sn-3.0Ag-0.5Cu) 235±5°C H60A or H63A Eutectic Solder																															
13	Resistance to Soldering Heat	Appearance	No marking defects	Preheat the capacitor at 120 to 150°C* for 1 min. Immerse the capacitor in solder solution at 260±5°C for 10±1 sec. Let sit at room condition* for 24±2 hrs., then measure. •Immersing speed: 25±2.5mm/s *Preheating for more than 3.2×2.5mm																														
		Capacitance Change	Within ±2.5%																															
		Q	1,000 min.																															
		I.R.	More than 10,000MΩ																															
		Dielectric Strength	In accordance with item No.4																															
14	Temperature Cycle	Appearance	No marking defects	Fix the capacitor to the supporting jig (glass epoxy board) shown in Fig. 4. Perform the 5 cycles according to the 4 heat treatments listed in the following table. Let sit for 24±2 hrs. at room condition,* then measure.																														
		Capacitance Change	Within ±2.5%																															
		Q	500 min.																															
		I.R.	More than 10,000MΩ																															
		Dielectric Strength	In accordance with item No.4																															
15	Humidity (Steady State)	Appearance	No marking defects	Let the capacitor sit at 40±2°C and relative humidity of 90 to 95% for 500 <sup>+24</sup> hrs. Remove and let sit for 24±2 hrs. at room condition,* then measure.																														
		Capacitance Change	Within ±5.0%																															
		Q	350 min.																															
		I.R.	More than 1,000MΩ																															
		Dielectric Strength	In accordance with item No.4																															
16	Life	Appearance	No marking defects	Apply voltage as in Table for 1,000 <sup>+48</sup> hrs. at maximum operating temperature ±3°C. Remove and let sit for 24±2 hrs. at room condition,* then measure.																														
		Capacitance Change	Within ±3.0%																															
		Q	350 min.																															
		I.R.	More than 1,000MΩ																															
		Dielectric Strength	In accordance with item No.4																															

Step	Temperature	Time
1	100 to 120°C	1 min.
2	170 to 200°C	1 min.

Step	Temperature (°C)	Time (min.)
1	Min. Operating Temp.±3	30±3
2	Room Temp.	2 to 3
3	Max. Operating Temp.±2	30±3
4	Room Temp.	2 to 3

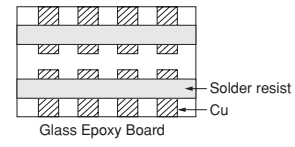

Fig. 4

Rated Voltage	Applied Voltage
DC250V	150% of the rated voltage
DC630V, DC1kV, DC2kV, DC3.15kV	120% of the rated voltage

\* "Room condition" Temperature: 15 to 35°C, Relative humidity: 45 to 75%, Atmospheric pressure: 86 to 106kPa

For General Purpose GRM/GRU/GR3 Series

Only for Applications

AC250V Type GA2 Series

Safety Standard Certified GA3 Series

Product Information

## Chip Monolithic Ceramic Capacitors (Medium Voltage)

# High Dielectric Constant Type GRM Series (250Vdc min.)

### ■ Features

1. A new monolithic structure for small, high capacitance capable of operating at high voltage levels.
2. Sn-plated external electrodes provide good solderability.
3. Use the GRM18/21/31 types with flow or reflow soldering, and other types with reflow soldering only.

### ■ Applications

1. Ideal for use on clamp-snubber circuits for switching power supplies.
2. Ideal for use as primary-secondary coupling for DC-DC converters.
3. Ideal for use on line filters and ringer detectors for telephones, facsimiles and modems.

Do not use these products in any Automotive Power train or Safety equipment including Battery chargers for Electric Vehicles and Plug-in Hybrids. Only Murata products clearly stipulated as "for Automotive use" can be used for automobile applications such as Power train and Safety equipment.

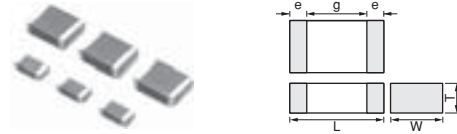

Part Number	Dimensions (mm)					
	L	W	T	e	g min.	
GRM188	1.6 ±0.1	0.8 ±0.1	0.8 ±0.1	0.2 to 0.5	0.4	
GRM21A	2.0 ±0.2	1.25 ±0.2	1.0 +0,-0.3			
GRM21B			1.25 ±0.2			
GRM31B	3.2 ±0.2	1.6 ±0.2	1.25 +0,-0.3	0.3 min.	1.2	
GRM31C			1.6 ±0.2			
GRM32Q	3.2 ±0.3	2.5 ±0.2	1.5 +0,-0.3			
GRM32D			2.0 +0,-0.3			
GRM43Q	4.5 ±0.4	3.2 ±0.3	1.5 +0,-0.3			2.2
GRM43D			2.0 +0,-0.3			
GRM55D	5.7 ±0.4	5.0 ±0.4	2.0 +0,-0.3	3.2		

Part Number	Rated Voltage	TC Code (Standard)	Capacitance	Length L (mm)	Width W (mm)	Thickness T max. (mm)	Electrode g min.	Electrode e
GRM188R72E221KW07D	250Vdc	X7R (EIA)	220pF±10%	1.6	0.8	0.9	0.4mm	0.2 to 0.5mm
GRM188R72E331KW07D	250Vdc	X7R (EIA)	330pF±10%	1.6	0.8	0.9	0.4mm	0.2 to 0.5mm
GRM188R72E471KW07D	250Vdc	X7R (EIA)	470pF±10%	1.6	0.8	0.9	0.4mm	0.2 to 0.5mm
GRM188R72E681KW07D	250Vdc	X7R (EIA)	680pF±10%	1.6	0.8	0.9	0.4mm	0.2 to 0.5mm
GRM188R72E102KW07D	250Vdc	X7R (EIA)	1000pF±10%	1.6	0.8	0.9	0.4mm	0.2 to 0.5mm
GRM21AR72E102KW01D	250Vdc	X7R (EIA)	1000pF±10%	2	1.25	1	0.7mm	0.3mm min.
GRM188R72E152KW07D	250Vdc	X7R (EIA)	1500pF±10%	1.6	0.8	0.9	0.4mm	0.2 to 0.5mm
GRM21AR72E152KW01D	250Vdc	X7R (EIA)	1500pF±10%	2	1.25	1	0.7mm	0.3mm min.
GRM188R72E222KW07D	250Vdc	X7R (EIA)	2200pF±10%	1.6	0.8	0.9	0.4mm	0.2 to 0.5mm
GRM21AR72E222KW01D	250Vdc	X7R (EIA)	2200pF±10%	2	1.25	1	0.7mm	0.3mm min.
GRM21AR72E332KW01D	250Vdc	X7R (EIA)	3300pF±10%	2	1.25	1	0.7mm	0.3mm min.
GRM21AR72E472KW01D	250Vdc	X7R (EIA)	4700pF±10%	2	1.25	1	0.7mm	0.3mm min.
GRM21AR72E682KW01D	250Vdc	X7R (EIA)	6800pF±10%	2	1.25	1	0.7mm	0.3mm min.
GRM21BR72E103KW03L	250Vdc	X7R (EIA)	10000pF±10%	2	1.25	1.45	0.7mm	0.3mm min.
GRM31BR72E153KW01L	250Vdc	X7R (EIA)	15000pF±10%	3.2	1.6	1.25	1.2mm	0.3mm min.
GRM31BR72E223KW01L	250Vdc	X7R (EIA)	22000pF±10%	3.2	1.6	1.25	1.2mm	0.3mm min.
GRM31CR72E333KW03L	250Vdc	X7R (EIA)	33000pF±10%	3.2	1.6	1.8	1.2mm	0.3mm min.
GRM31CR72E473KW03L	250Vdc	X7R (EIA)	47000pF±10%	3.2	1.6	1.8	1.2mm	0.3mm min.
GRM31BR72E683KW01L	250Vdc	X7R (EIA)	68000pF±10%	3.2	1.6	1.25	1.2mm	0.3mm min.
GRM32QR72E683KW01L	250Vdc	X7R (EIA)	68000pF±10%	3.2	2.5	1.5	1.2mm	0.3mm min.
GRM31CR72E104KW03L	250Vdc	X7R (EIA)	0.10µF±10%	3.2	1.6	1.8	1.2mm	0.3mm min.
GRM32DR72E104KW01L	250Vdc	X7R (EIA)	0.10µF±10%	3.2	2.5	2	1.2mm	0.3mm min.
GRM32QR72E154KW01L	250Vdc	X7R (EIA)	0.15µF±10%	3.2	2.5	1.5	1.2mm	0.3mm min.
GRM43QR72E154KW01L	250Vdc	X7R (EIA)	0.15µF±10%	4.5	3.2	1.5	2.2mm	0.3mm min.
GRM32DR72E224KW01L	250Vdc	X7R (EIA)	0.22µF±10%	3.2	2.5	2	1.2mm	0.3mm min.

Continued on the following page.

Continued from the preceding page.

Part Number	Rated Voltage	TC Code (Standard)	Capacitance	Length L (mm)	Width W (mm)	Thickness T max. (mm)	Electrode g min.	Electrode e
GRM43DR72E224KW01L	250Vdc	X7R (EIA)	0.22μF±10%	4.5	3.2	2	2.2mm	0.3mm min.
GRM43DR72E334KW01L	250Vdc	X7R (EIA)	0.33μF±10%	4.5	3.2	2	2.2mm	0.3mm min.
GRM55DR72E334KW01L	250Vdc	X7R (EIA)	0.33μF±10%	5.7	5.0	2	3.2mm	0.3mm min.
GRM43DR72E474KW01L	250Vdc	X7R (EIA)	0.47μF±10%	4.5	3.2	2	2.2mm	0.3mm min.
GRM55DR72E474KW01L	250Vdc	X7R (EIA)	0.47μF±10%	5.7	5.0	2	3.2mm	0.3mm min.
GRM55DR72E684KW01L	250Vdc	X7R (EIA)	0.68μF±10%	5.7	5.0	2	3.2mm	0.3mm min.
GRM55DR72E105KW01L	250Vdc	X7R (EIA)	1.0μF±10%	5.7	5.0	2	3.2mm	0.3mm min.
GRM31BR72J102KW01L	630Vdc	X7R (EIA)	1000pF±10%	3.2	1.6	1.25	1.2mm	0.3mm min.
GRM31BR72J152KW01L	630Vdc	X7R (EIA)	1500pF±10%	3.2	1.6	1.25	1.2mm	0.3mm min.
GRM31BR72J222KW01L	630Vdc	X7R (EIA)	2200pF±10%	3.2	1.6	1.25	1.2mm	0.3mm min.
GRM31BR72J332KW01L	630Vdc	X7R (EIA)	3300pF±10%	3.2	1.6	1.25	1.2mm	0.3mm min.
GRM31BR72J472KW01L	630Vdc	X7R (EIA)	4700pF±10%	3.2	1.6	1.25	1.2mm	0.3mm min.
GRM31BR72J682KW01L	630Vdc	X7R (EIA)	6800pF±10%	3.2	1.6	1.25	1.2mm	0.3mm min.
GRM31BR72J103KW01L	630Vdc	X7R (EIA)	10000pF±10%	3.2	1.6	1.25	1.2mm	0.3mm min.
GRM31CR72J153KW03L	630Vdc	X7R (EIA)	15000pF±10%	3.2	1.6	1.8	1.2mm	0.3mm min.
GRM32QR72J223KW01L	630Vdc	X7R (EIA)	22000pF±10%	3.2	2.5	1.5	1.2mm	0.3mm min.
GRM32DR72J333KW01L	630Vdc	X7R (EIA)	33000pF±10%	3.2	2.5	2	1.2mm	0.3mm min.
GRM32DR72J473KW01L	630Vdc	X7R (EIA)	47000pF±10%	3.2	2.5	2	1.2mm	0.3mm min.
GRM43QR72J683KW01L	630Vdc	X7R (EIA)	68000pF±10%	4.5	3.2	1.5	2.2mm	0.3mm min.
GRM43DR72J104KW01L	630Vdc	X7R (EIA)	0.10μF±10%	4.5	3.2	2	2.2mm	0.3mm min.
GRM55DR72J154KW01L	630Vdc	X7R (EIA)	0.15μF±10%	5.7	5.0	2	3.2mm	0.3mm min.
GRM55DR72J224KW01L	630Vdc	X7R (EIA)	0.22μF±10%	5.7	5.0	2	3.2mm	0.3mm min.
GRM31BR73A471KW01L	1000Vdc	X7R (EIA)	470pF±10%	3.2	1.6	1.25	1.2mm	0.3mm min.
GRM31BR73A681KW01L	1000Vdc	X7R (EIA)	680pF±10%	3.2	1.6	1.25	1.2mm	0.3mm min.
GRM31BR73A102KW01L	1000Vdc	X7R (EIA)	1000pF±10%	3.2	1.6	1.25	1.2mm	0.3mm min.
GRM31BR73A152KW01L	1000Vdc	X7R (EIA)	1500pF±10%	3.2	1.6	1.25	1.2mm	0.3mm min.
GRM31BR73A222KW01L	1000Vdc	X7R (EIA)	2200pF±10%	3.2	1.6	1.25	1.2mm	0.3mm min.
GRM31BR73A332KW01L	1000Vdc	X7R (EIA)	3300pF±10%	3.2	1.6	1.25	1.2mm	0.3mm min.
GRM31BR73A472KW01L	1000Vdc	X7R (EIA)	4700pF±10%	3.2	1.6	1.25	1.2mm	0.3mm min.
GRM32QR73A682KW01L	1000Vdc	X7R (EIA)	6800pF±10%	3.2	2.5	1.5	1.2mm	0.3mm min.
GRM32QR73A103KW01L	1000Vdc	X7R (EIA)	10000pF±10%	3.2	2.5	1.5	1.2mm	0.3mm min.
GRM32DR73A153KW01L	1000Vdc	X7R (EIA)	15000pF±10%	3.2	2.5	2	1.2mm	0.3mm min.
GRM32DR73A223KW01L	1000Vdc	X7R (EIA)	22000pF±10%	3.2	2.5	2	1.2mm	0.3mm min.
GRM43DR73A333KW01L	1000Vdc	X7R (EIA)	33000pF±10%	4.5	3.2	2	2.2mm	0.3mm min.
GRM43DR73A473KW01L	1000Vdc	X7R (EIA)	47000pF±10%	4.5	3.2	2	2.2mm	0.3mm min.
GRM55DR73A683KW01L	1000Vdc	X7R (EIA)	68000pF±10%	5.7	5.0	2	3.2mm	0.3mm min.
GRM55DR73A104KW01L	1000Vdc	X7R (EIA)	0.10μF±10%	5.7	5.0	2	3.2mm	0.3mm min.

For General Purpose  
 GRM/GRJ/GR3 Series

Only for Applications

AC250V Type  
 GA2 Series

Safety Standard  
 Certified GA3 Series

Product Information

## GRM Series Specifications and Test Methods

No.	Item	Specifications	Test Method									
1	Operating Temperature Range	-55 to +125°C	-									
2	Appearance	No defects or abnormalities	Visual inspection									
3	Dimensions	Within the specified dimensions	Using calipers and micrometers									
4	Dielectric Strength	No defects or abnormalities	No failure should be observed when 150% of the rated voltage (200% of the rated voltage in case of rated voltage: DC250V, 120% of the rated voltage in case of rated voltage: DC1kV) is applied between the terminations for 1 to 5 sec., provided the charge/discharge current is less than 50mA.									
5	Insulation Resistance (I.R.)	C≥0.01μF: More than 100MΩ • μF C<0.01μF: More than 10,000MΩ	The insulation resistance should be measured with DC500±50V (DC250±25V in case of rated voltage: DC250V) and within 60±5 sec. of charging.									
6	Capacitance	Within the specified tolerance	The capacitance/D.F. should be measured at a frequency of 1±0.2kHz and a voltage of AC1±0.2V(r.m.s.).									
7	Dissipation Factor (D.F.)	0.025 max.										
8	Capacitance Temperature Characteristics	Cap. Change Within ±15% (Temp. Range: -55 to +125°C)	The capacitance measurement should be made at each step specified in the Table.									
			<table border="1" style="width: 100%; border-collapse: collapse; text-align: center;"> <thead> <tr style="background-color: #f2f2f2;"> <th style="width: 20%;">Step</th> <th style="width: 80%;">Temperature (°C)</th> </tr> </thead> <tbody> <tr> <td>1</td> <td>25±2</td> </tr> <tr> <td>2</td> <td>Min. Operating Temp.±3</td> </tr> <tr> <td>3</td> <td>25±2</td> </tr> <tr> <td>4</td> <td>Max. Operating Temp.±2</td> </tr> <tr> <td>5</td> <td>25±2</td> </tr> </tbody> </table> <p>•Pretreatment                      Perform a heat treatment at 150±9<sub>0</sub>°C for 60±5 min. and then let sit for 24±2 hrs. at room condition.*</p>	Step	Temperature (°C)	1	25±2	2	Min. Operating Temp.±3	3	25±2	4
Step	Temperature (°C)											
1	25±2											
2	Min. Operating Temp.±3											
3	25±2											
4	Max. Operating Temp.±2											
5	25±2											
9	Adhesive Strength of Termination	No removal of the terminations or other defect should occur.	Solder the capacitor to the testing jig (glass epoxy board) shown in Fig. 1. Then apply 10N force in the direction of the arrow. The soldering should be done using the reflow method and should be conducted with care so that the soldering is uniform and free of defects such as heat shock.									
10	Vibration Resistance	Appearance	No defects or abnormalities									
		Capacitance	Within the specified tolerance									
		D.F.	0.025 max.									
			Solder the capacitor to the test jig (glass epoxy board). The capacitor should be subjected to a simple harmonic motion having a total amplitude of 1.5mm, the frequency being varied uniformly between the approximate limits of 10 and 55Hz. The frequency range, from 10 to 55Hz and return to 10Hz, should be traversed in approximately 1 min. This motion should be applied for a period of 2 hrs. in each of 3 mutually perpendicular directions (total of 6 hrs.).									

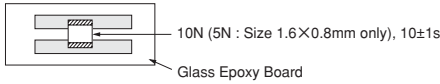
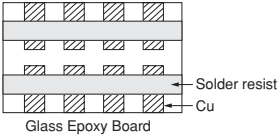

Fig. 1



\* "Room condition" Temperature: 15 to 35°C, Relative humidity: 45 to 75%, Atmospheric pressure: 86 to 106kPa

Continued on the following page.

For General Purpose GRM/GRJ/GR3 Series  
 Only for Applications  
 AC250V Type GA2 Series  
 Safety Standard Certified GA3 Series  
 Product Information

# GRM Series Specifications and Test Methods

Continued from the preceding page.

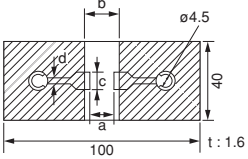
No.	Item	Specifications	Test Method																																
11	Deflection	No marking defects	Solder the capacitor to the testing jig (glass epoxy board) shown in Fig. 2. Then apply a force in the direction shown in Fig. 3. The soldering should be done using the reflow method and should be conducted with care so that the soldering is uniform and free of defects such as heat shock.																																
		 <p>Fig. 2</p> <table border="1"> <thead> <tr> <th>L×W (mm)</th> <th colspan="4">Dimension (mm)</th> </tr> <tr> <th></th> <th>a</th> <th>b</th> <th>c</th> <th>d</th> </tr> </thead> <tbody> <tr> <td>1.6×0.8</td> <td>1.0</td> <td>3.0</td> <td>1.2</td> <td rowspan="6">1.0</td> </tr> <tr> <td>2.0×1.25</td> <td>1.2</td> <td>4.0</td> <td>1.65</td> </tr> <tr> <td>3.2×1.6</td> <td>2.2</td> <td>5.0</td> <td>2.0</td> </tr> <tr> <td>3.2×2.5</td> <td>2.2</td> <td>5.0</td> <td>2.9</td> </tr> <tr> <td>4.5×3.2</td> <td>3.5</td> <td>7.0</td> <td>3.7</td> </tr> <tr> <td>5.7×5.0</td> <td>4.5</td> <td>8.0</td> <td>5.6</td> </tr> </tbody> </table>		L×W (mm)	Dimension (mm)					a	b	c	d	1.6×0.8	1.0	3.0	1.2	1.0	2.0×1.25	1.2	4.0	1.65	3.2×1.6	2.2	5.0	2.0	3.2×2.5	2.2	5.0	2.9	4.5×3.2	3.5	7.0	3.7	5.7×5.0
L×W (mm)	Dimension (mm)																																		
	a	b	c	d																															
1.6×0.8	1.0	3.0	1.2	1.0																															
2.0×1.25	1.2	4.0	1.65																																
3.2×1.6	2.2	5.0	2.0																																
3.2×2.5	2.2	5.0	2.9																																
4.5×3.2	3.5	7.0	3.7																																
5.7×5.0	4.5	8.0	5.6																																
12	Solderability of Termination	75% of the terminations are to be soldered evenly and continuously.	Immerse the capacitor in a solution of ethanol (JIS-K-8101) and rosin (JIS-K-5902) (25% rosin in weight proportion). Immerse in solder solution for 2±0.5 sec. Immersing speed: 25±2.5mm/s Temp. of solder: 245±5°C Lead Free Solder (Sn-3.0Ag-0.5Cu) 235±5°C H60A or H63A Eutectic Solder																																
13	Resistance to Soldering Heat	Appearance	No marking defects	Preheat the capacitor at 120 to 150°C* for 1 min. Immerse the capacitor in solder solution at 260±5°C for 10±1 sec. Let sit at room condition* for 24±2 hrs., then measure. •Immersing speed: 25±2.5mm/s •Pretreatment Perform a heat treatment at 150±18°C for 60±5 min. and then let sit for 24±2 hrs. at room condition.*  *Preheating for more than 3.2×2.5mm																															
		Capacitance Change	Within ±10%																																
		D.F.	0.025 max.																																
		I.R.	C≥0.01μF: More than 100MΩ • μF C<0.01μF: More than 10,000MΩ																																
		Dielectric Strength	In accordance with item No.4																																
14	Temperature Cycle	Appearance	No marking defects	Fix the capacitor to the supporting jig (glass epoxy board) shown in Fig. 4. Perform the 5 cycles according to the 4 heat treatments listed in the following table. Let sit for 24±2 hrs. at room condition,* then measure.																															
		Capacitance Change	Within ±7.5%																																
		D.F.	0.025 max.																																
		I.R.	C≥0.01μF: More than 100MΩ • μF C<0.01μF: More than 10,000MΩ																																
		Dielectric Strength	In accordance with item No.4																																
15	Humidity (Steady State)	Appearance	No marking defects	Let the capacitor sit at 40±2°C and relative humidity of 90 to 95% for 500±23hrs. Remove and let sit for 24±2 hrs. at room condition,* then measure. •Pretreatment Perform a heat treatment at 150±18°C for 60±5 min. and then let sit for 24±2 hrs. at room condition.*																															
		Capacitance Change	Within ±15%																																
		D.F.	0.05 max.																																
		I.R.	C≥0.01μF: More than 10MΩ • μF C<0.01μF: More than 1,000MΩ																																
		Dielectric Strength	In accordance with item No.4																																

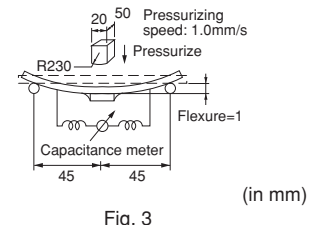

Step	Temperature	Time
1	100 to 120°C	1 min.
2	170 to 200°C	1 min.

Step	Temperature (°C)	Time (min.)
1	Min. Operating Temp.±3	30±3
2	Room Temp.	2 to 3
3	Max. Operating Temp.±2	30±3
4	Room Temp.	2 to 3

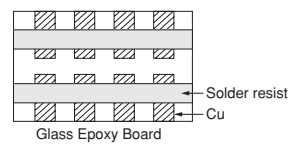

\* "Room condition" Temperature: 15 to 35°C, Relative humidity: 45 to 75%, Atmospheric pressure: 86 to 106kPa

Continued on the following page. ↗

For General Purpose GRM/GRU/GR3 Series

Only for Applications

AC250V Type GA2 Series

Safety Standard Certified GA3 Series

Product Information



## GRM Series Specifications and Test Methods

↳ Continued from the preceding page.

No.	Item	Specifications	Test Method	
16	Life	Appearance	No marking defects	Apply 120% of the rated voltage (150% of the rated voltage in case of rated voltage: DC250V, 110% of the rated voltage in case of rated voltage: DC1kV) for 1,000±48hrs. at maximum operating temperature ±3°C. Remove and let sit for 24±2hrs. at room condition,* then measure. The charge/discharge current is less than 50mA. <b>•Pretreatment</b> Apply test voltage for 60±5 min. at test temperature. Remove and let sit for 24±2 hrs. at room condition.*
		Capacitance Change	Within ±15% (rated voltage: DC250V, DC630V) Within ±20% (rated voltage: DC1kV)	
		D.F.	0.05 max.	
		I.R.	C≥0.01μF: More than 10MΩ • μF C<0.01μF: More than 1,000MΩ	
		Dielectric Strength	In accordance with item No.4	
17	Humidity Loading (Application: DC250V, DC630V item)	Appearance	No marking defects	Apply the rated voltage at 40±2°C and relative humidity of 90 to 95% for 500±24hrs. Remove and let sit for 24±2 hrs. at room condition,* then measure. <b>•Pretreatment</b> Apply test voltage for 60±5 min. at test temperature. Remove and let sit for 24±2 hrs. at room condition.*
		Capacitance Change	Within ±15%	
		D.F.	0.05 max.	
		I.R.	C≥0.01μF: More than 10MΩ • μF C<0.01μF: More than 1,000MΩ	
		Dielectric Strength	In accordance with item No.4	

\* "Room condition" Temperature: 15 to 35°C, Relative humidity: 45 to 75%, Atmospheric pressure: 86 to 106kPa

For General Purpose  
GRM/GRJ/GR3 Series

Only for Applications

AC250V Type  
GA2 Series

Safety Standard  
Certified GA3 Series

Product Information

## Chip Monolithic Ceramic Capacitors (Medium Voltage)

# Soft Termination Type GRJ Series

**Deflecting crack**

### ■ Features

1. Improves endurance against Board Bending Stress.
2. Reduces the board bending stress by the conductive polymer termination.
3. Use the GRJ21/31 types with flow or reflow soldering, and other types with reflow soldering only.

### ■ Applications

1. Ideal for use on clamp-snubber circuits for switching power supplies.
2. Ideal for use as primary-secondary coupling for DC-DC converters.
3. Ideal for use on line filters and ringer detectors for telephones, facsimiles and modems.

Do not use these products in any Automotive Power train or Safety equipment including Battery chargers for Electric Vehicles and Plug-in Hybrids. Only Murata products clearly stipulated as "for Automotive use" can be used for automobile applications such as Power train and Safety equipment.

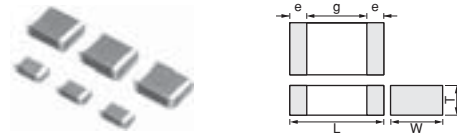

Part Number	Dimensions (mm)				
	L	W	T	e	g min.
GRJ21A	2.0 ±0.2	1.25 ±0.2	1.0 +0,-0.3	0.3 min.	0.7
GRJ21B			1.25 ±0.2		
GRJ31B	3.2 ±0.2	1.6 ±0.2	1.25 +0,-0.3		1.2
GRJ31C			1.6 ±0.2		
GRJ32Q			1.5 +0,-0.3		
GRJ32D	3.2 ±0.3	2.5 ±0.2	2.0 +0,-0.3		2.2
GRJ43Q			1.5 +0,-0.3		
GRJ43D	4.5 ±0.4	3.2 ±0.3	2.0 +0,-0.3		3.2
GRJ55D			2.0 +0,-0.3		

Part Number	Rated Voltage	TC Code (Standard)	Capacitance	Length L (mm)	Width W (mm)	Thickness T max. (mm)	Electrode g min.	Electrode e
GRJ21AR72E102KWJ1D	250Vdc	X7R (EIA)	1000pF±10%	2	1.25	1	0.7mm	0.3mm min.
GRJ21AR72E152KWJ1D	250Vdc	X7R (EIA)	1500pF±10%	2	1.25	1	0.7mm	0.3mm min.
GRJ21AR72E222KWJ1D	250Vdc	X7R (EIA)	2200pF±10%	2	1.25	1	0.7mm	0.3mm min.
GRJ21AR72E332KWJ1D	250Vdc	X7R (EIA)	3300pF±10%	2	1.25	1	0.7mm	0.3mm min.
GRJ21AR72E472KWJ1D	250Vdc	X7R (EIA)	4700pF±10%	2	1.25	1	0.7mm	0.3mm min.
GRJ21AR72E682KWJ1D	250Vdc	X7R (EIA)	6800pF±10%	2	1.25	1	0.7mm	0.3mm min.
GRJ21BR72E103KWJ3L	250Vdc	X7R (EIA)	10000pF±10%	2	1.25	1.45	0.7mm	0.3mm min.
GRJ21BR72E153KWJ3L	250Vdc	X7R (EIA)	15000pF±10%	2	1.25	1.45	0.7mm	0.3mm min.
GRJ31BR72E153KWJ1L	250Vdc	X7R (EIA)	15000pF±10%	3.2	1.6	1.25	1.2mm	0.3mm min.
GRJ21BR72E223KWJ3L	250Vdc	X7R (EIA)	22000pF±10%	2	1.25	1.45	0.7mm	0.3mm min.
GRJ31BR72E223KWJ1L	250Vdc	X7R (EIA)	22000pF±10%	3.2	1.6	1.25	1.2mm	0.3mm min.
GRJ31CR72E333KWJ3L	250Vdc	X7R (EIA)	33000pF±10%	3.2	1.6	1.8	1.2mm	0.3mm min.
GRJ31CR72E473KWJ3L	250Vdc	X7R (EIA)	47000pF±10%	3.2	1.6	1.8	1.2mm	0.3mm min.
GRJ31BR72E683KWJ1L	250Vdc	X7R (EIA)	68000pF±10%	3.2	1.6	1.25	1.2mm	0.3mm min.
GRJ32QR72E683KWJ1L	250Vdc	X7R (EIA)	68000pF±10%	3.2	2.5	1.5	1.2mm	0.3mm min.
GRJ31CR72E104KWJ3L	250Vdc	X7R (EIA)	0.10µF±10%	3.2	1.6	1.8	1.2mm	0.3mm min.
GRJ32DR72E104KWJ1L	250Vdc	X7R (EIA)	0.10µF±10%	3.2	2.5	2	1.2mm	0.3mm min.
GRJ32QR72E154KWJ1L	250Vdc	X7R (EIA)	0.15µF±10%	3.2	2.5	1.5	1.2mm	0.3mm min.
GRJ43QR72E154KWJ1L	250Vdc	X7R (EIA)	0.15µF±10%	4.5	3.2	1.5	2.2mm	0.3mm min.
GRJ32DR72E224KWJ1L	250Vdc	X7R (EIA)	0.22µF±10%	3.2	2.5	2	1.2mm	0.3mm min.
GRJ43DR72E224KWJ1L	250Vdc	X7R (EIA)	0.22µF±10%	4.5	3.2	2	2.2mm	0.3mm min.
GRJ43DR72E334KWJ1L	250Vdc	X7R (EIA)	0.33µF±10%	4.5	3.2	2	2.2mm	0.3mm min.
GRJ55DR72E334KWJ1L	250Vdc	X7R (EIA)	0.33µF±10%	5.7	5	2	3.2mm	0.3mm min.
GRJ43DR72E474KWJ1L	250Vdc	X7R (EIA)	0.47µF±10%	4.5	3.2	2	2.2mm	0.3mm min.
GRJ55DR72E474KWJ1L	250Vdc	X7R (EIA)	0.47µF±10%	5.7	5	2	3.2mm	0.3mm min.
GRJ55DR72E684KWJ1L	250Vdc	X7R (EIA)	0.68µF±10%	5.7	5	2	3.2mm	0.3mm min.
GRJ55DR72E105KWJ1L	250Vdc	X7R (EIA)	1.0µF±10%	5.7	5	2	3.2mm	0.3mm min.

Continued on the following page. ↗

For General Purpose GRM/GRU/GR3 Series  
 Only for Applications  
 AC250V Type GA2 Series  
 Safety Standard Certified GA3 Series  
 Product Information

Continued from the preceding page.

Part Number	Rated Voltage	TC Code (Standard)	Capacitance	Length L (mm)	Width W (mm)	Thickness T max. (mm)	Electrode g min.	Electrode e
GRJ31BR72J102KWJ1L	630Vdc	X7R (EIA)	1000pF±10%	3.2	1.6	1.25	1.2mm	0.3mm min.
GRJ31BR72J152KWJ1L	630Vdc	X7R (EIA)	1500pF±10%	3.2	1.6	1.25	1.2mm	0.3mm min.
GRJ31BR72J222KWJ1L	630Vdc	X7R (EIA)	2200pF±10%	3.2	1.6	1.25	1.2mm	0.3mm min.
GRJ31BR72J332KWJ1L	630Vdc	X7R (EIA)	3300pF±10%	3.2	1.6	1.25	1.2mm	0.3mm min.
GRJ31BR72J472KWJ1L	630Vdc	X7R (EIA)	4700pF±10%	3.2	1.6	1.25	1.2mm	0.3mm min.
GRJ31BR72J682KWJ1L	630Vdc	X7R (EIA)	6800pF±10%	3.2	1.6	1.25	1.2mm	0.3mm min.
GRJ31BR72J103KWJ1L	630Vdc	X7R (EIA)	10000pF±10%	3.2	1.6	1.25	1.2mm	0.3mm min.
GRJ31CR72J153KWJ3L	630Vdc	X7R (EIA)	15000pF±10%	3.2	1.6	1.8	1.2mm	0.3mm min.
GRJ31CR72J223KWJ3L	630Vdc	X7R (EIA)	22000pF±10%	3.2	1.6	1.8	1.2mm	0.3mm min.
GRJ32QR72J223KWJ1L	630Vdc	X7R (EIA)	22000pF±10%	3.2	2.5	1.5	1.2mm	0.3mm min.
GRJ32DR72J333KWJ1L	630Vdc	X7R (EIA)	33000pF±10%	3.2	2.5	2	1.2mm	0.3mm min.
GRJ32DR72J473KWJ1L	630Vdc	X7R (EIA)	47000pF±10%	3.2	2.5	2	1.2mm	0.3mm min.
GRJ43QR72J683KWJ1L	630Vdc	X7R (EIA)	68000pF±10%	4.5	3.2	1.5	2.2mm	0.3mm min.
GRJ43DR72J104KWJ1L	630Vdc	X7R (EIA)	0.10μF±10%	4.5	3.2	2	2.2mm	0.3mm min.
GRJ55DR72J154KWJ1L	630Vdc	X7R (EIA)	0.15μF±10%	5.7	5	2	3.2mm	0.3mm min.
GRJ55DR72J224KWJ1L	630Vdc	X7R (EIA)	0.22μF±10%	5.7	5	2	3.2mm	0.3mm min.
GRJ31BR73A471KWJ1L	1000Vdc	X7R (EIA)	470pF±10%	3.2	1.6	1.25	1.2mm	0.3mm min.
GRJ31BR73A681KWJ1L	1000Vdc	X7R (EIA)	680pF±10%	3.2	1.6	1.25	1.2mm	0.3mm min.
GRJ31BR73A102KWJ1L	1000Vdc	X7R (EIA)	1000pF±10%	3.2	1.6	1.25	1.2mm	0.3mm min.
GRJ31BR73A152KWJ1L	1000Vdc	X7R (EIA)	1500pF±10%	3.2	1.6	1.25	1.2mm	0.3mm min.
GRJ31BR73A222KWJ1L	1000Vdc	X7R (EIA)	2200pF±10%	3.2	1.6	1.25	1.2mm	0.3mm min.
GRJ31BR73A332KWJ1L	1000Vdc	X7R (EIA)	3300pF±10%	3.2	1.6	1.25	1.2mm	0.3mm min.
GRJ31BR73A472KWJ1L	1000Vdc	X7R (EIA)	4700pF±10%	3.2	1.6	1.25	1.2mm	0.3mm min.
GRJ31CR73A682KWJ3L	1000Vdc	X7R (EIA)	6800pF±10%	3.2	1.6	1.8	1.2mm	0.3mm min.
GRJ32QR73A682KWJ1L	1000Vdc	X7R (EIA)	6800pF±10%	3.2	2.5	1.5	1.2mm	0.3mm min.
GRJ31CR73A103KWJ3L	1000Vdc	X7R (EIA)	10000pF±10%	3.2	1.6	1.8	1.2mm	0.3mm min.
GRJ32QR73A103KWJ1L	1000Vdc	X7R (EIA)	10000pF±10%	3.2	2.5	1.5	1.2mm	0.3mm min.
GRJ32DR73A153KWJ1L	1000Vdc	X7R (EIA)	15000pF±10%	3.2	2.5	2	1.2mm	0.3mm min.
GRJ32DR73A223KWJ1L	1000Vdc	X7R (EIA)	22000pF±10%	3.2	2.5	2	1.2mm	0.3mm min.
GRJ43DR73A333KWJ1L	1000Vdc	X7R (EIA)	33000pF±10%	4.5	3.2	2	2.2mm	0.3mm min.
GRJ43DR73A473KWJ1L	1000Vdc	X7R (EIA)	47000pF±10%	4.5	3.2	2	2.2mm	0.3mm min.
GRJ55DR73A683KWJ1L	1000Vdc	X7R (EIA)	68000pF±10%	5.7	5	2	3.2mm	0.3mm min.
GRJ55DR73A104KWJ1L	1000Vdc	X7R (EIA)	0.10μF±10%	5.7	5	2	3.2mm	0.3mm min.

For General Purpose GRM/GRJ/GR3 Series

Only for Applications

AC250V Type GA2 Series

Safety Standard Certified GA3 Series

Product Information

## GRJ Series Specifications and Test Methods

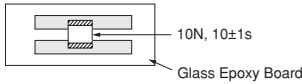
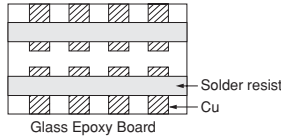
No.	Item	Specifications	Test Method												
1	Operating Temperature Range	-55 to +125°C	-												
2	Appearance	No defects or abnormalities	Visual inspection												
3	Dimensions	Within the specified dimensions	Using calipers and micrometers												
4	Dielectric Strength	No defects or abnormalities	No failure should be observed when voltage in the Table is applied between the terminations for 1 to 5 sec., provided the charge/discharge current is less than 50mA. <table border="1"> <thead> <tr> <th>Rated Voltage</th> <th>Test Voltage</th> </tr> </thead> <tbody> <tr> <td>DC250V</td> <td>200% of the rated voltage</td> </tr> <tr> <td>DC630V</td> <td>150% of the rated voltage</td> </tr> <tr> <td>DC1kV</td> <td>120% of the rated voltage</td> </tr> </tbody> </table>	Rated Voltage	Test Voltage	DC250V	200% of the rated voltage	DC630V	150% of the rated voltage	DC1kV	120% of the rated voltage				
Rated Voltage	Test Voltage														
DC250V	200% of the rated voltage														
DC630V	150% of the rated voltage														
DC1kV	120% of the rated voltage														
5	Insulation Resistance (I.R.)	C≥0.01μF: More than 100MΩ • μF C<0.01μF: More than 10,000MΩ	The insulation resistance should be measured with DC500±50V (DC250±25V in case of rated voltage: DC250V) and within 60±5 sec. of charging.												
6	Capacitance	Within the specified tolerance	The capacitance/D.F. should be measured at a frequency of 1±0.2kHz and a voltage of AC1±0.2V(r.m.s.).												
7	Dissipation Factor (D.F.)	0.025 max.													
8	Capacitance Temperature Characteristics	Cap. Change Within ±15% (Temp. Range: -55 to +125°C)	The capacitance measurement should be made at each step specified in the Table. <table border="1"> <thead> <tr> <th>Step</th> <th>Temperature (°C)</th> </tr> </thead> <tbody> <tr> <td>1</td> <td>25±2</td> </tr> <tr> <td>2</td> <td>Min. Operating Temp.±3</td> </tr> <tr> <td>3</td> <td>25±2</td> </tr> <tr> <td>4</td> <td>Max. Operating Temp.±2</td> </tr> <tr> <td>5</td> <td>25±2</td> </tr> </tbody> </table> <p>•Pretreatment                      Perform a heat treatment at 150±9°C for 60±5 min. and then let sit for 24±2 hrs. at room condition.*</p>	Step	Temperature (°C)	1	25±2	2	Min. Operating Temp.±3	3	25±2	4	Max. Operating Temp.±2	5	25±2
Step	Temperature (°C)														
1	25±2														
2	Min. Operating Temp.±3														
3	25±2														
4	Max. Operating Temp.±2														
5	25±2														
9	Adhesive Strength of Termination	No removal of the terminations or other defect should occur.	Solder the capacitor to the testing jig (glass epoxy board) shown in Fig. 1. Then apply 10N force in the direction of the arrow. The soldering should be done using the reflow method and should be conducted with care so that the soldering is uniform and free of defects such as heat shock.  Fig. 1												
10	Vibration Resistance	Appearance	No defects or abnormalities												
		Capacitance	Within the specified tolerance												
		D.F.	0.025 max.												
			Solder the capacitor to the test jig (glass epoxy board). The capacitor should be subjected to a simple harmonic motion having a total amplitude of 1.5mm, the frequency being varied uniformly between the approximate limits of 10 and 55Hz. The frequency range, from 10 to 55Hz and return to 10Hz, should be traversed in approximately 1 min. This motion should be applied for a period of 2 hrs. in each of 3 mutually perpendicular directions (total of 6 hrs.). 												

\* "Room condition" Temperature: 15 to 35°C, Relative humidity: 45 to 75%, Atmospheric pressure: 86 to 106kPa

Continued on the following page. 

For General Purpose GRM/GRU/GR3 Series  
 Only for Applications  
 AC250V Type GA2 Series  
 Safety Standard Certified GA3 Series  
 Product Information

## GRJ Series Specifications and Test Methods

Continued from the preceding page.

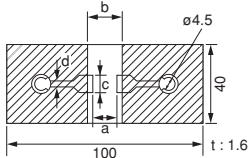
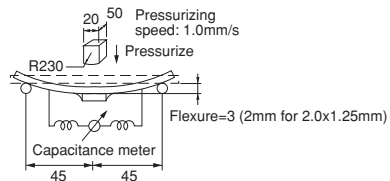
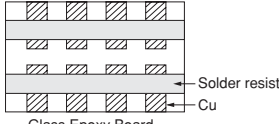
No.	Item	Specifications	Test Method																												
11	Appearance	No marking defects	Solder the capacitor to the testing jig (glass epoxy board) shown in Fig. 2. Then apply a force in the direction shown in Fig. 3. The soldering should be done using the reflow method and should be conducted with care so that the soldering is uniform and free of defects such as heat shock.																												
	Capacitance Change	Within $\pm 12.5\%$																													
		 <p style="text-align: center;">Fig. 2</p> <table border="1" style="margin-left: auto; margin-right: auto;"> <thead> <tr> <th>L×W (mm)</th> <th colspan="3">Dimension (mm)</th> <th rowspan="6" style="text-align: center; vertical-align: middle;">1.0</th> </tr> <tr> <th></th> <th>a</th> <th>b</th> <th>c</th> </tr> </thead> <tbody> <tr> <td>2.0×1.25</td> <td>1.2</td> <td>4.0</td> <td>1.65</td> </tr> <tr> <td>3.2×1.6</td> <td>2.2</td> <td>5.0</td> <td>2.0</td> </tr> <tr> <td>3.2×2.5</td> <td>2.2</td> <td>5.0</td> <td>2.9</td> </tr> <tr> <td>4.5×3.2</td> <td>3.5</td> <td>7.0</td> <td>3.7</td> </tr> <tr> <td>5.7×5.0</td> <td>4.5</td> <td>8.0</td> <td>5.6</td> </tr> </tbody> </table>	L×W (mm)	Dimension (mm)			1.0		a	b	c	2.0×1.25	1.2	4.0	1.65	3.2×1.6	2.2	5.0	2.0	3.2×2.5	2.2	5.0	2.9	4.5×3.2	3.5	7.0	3.7	5.7×5.0	4.5	8.0	5.6
L×W (mm)	Dimension (mm)			1.0																											
	a	b	c																												
2.0×1.25	1.2	4.0	1.65																												
3.2×1.6	2.2	5.0	2.0																												
3.2×2.5	2.2	5.0	2.9																												
4.5×3.2	3.5	7.0	3.7																												
5.7×5.0	4.5	8.0	5.6																												
			 <p style="text-align: center;">Fig. 3 (in mm)</p>																												
12	Solderability of Termination	75% of the terminations are to be soldered evenly and continuously.	Immerse the capacitor in a solution of ethanol (JIS-K-8101) and rosin (JIS-K-5902) (25% rosin in weight proportion). Immerse in solder solution for $2\pm 0.5$ sec. Immersing speed: $25\pm 2.5$ mm/s Temp. of solder: $245\pm 5^\circ\text{C}$ Lead Free Solder (Sn-3.0Ag-0.5Cu) $235\pm 5^\circ\text{C}$ H60A or H63A Eutectic Solder																												
13	Appearance	No marking defects	Preheat the capacitor at $120$ to $150^\circ\text{C}$ * for 1 min. Immerse the capacitor in solder solution at $260\pm 5^\circ\text{C}$ for $10\pm 1$ sec. Let sit at room condition* for $24\pm 2$ hrs., then measure. •Immersing speed: $25\pm 2.5$ mm/s •Pretreatment Perform a heat treatment at $150\pm 1^\circ\text{C}$ for $60\pm 5$ min. and then let sit for $24\pm 2$ hrs. at room condition.*  *Preheating for more than $3.2\times 2.5$ mm																												
	Resistance to Soldering Heat	Capacitance Change: Within $\pm 10\%$ D.F.: 0.025 max. I.R.: $C\geq 0.01\mu\text{F}$ : More than $100\text{M}\Omega \cdot \mu\text{F}$ $C < 0.01\mu\text{F}$ : More than $10,000\text{M}\Omega$																													
	Dielectric Strength	In accordance with item No.4																													
				<table border="1"> <thead> <tr> <th>Step</th> <th>Temperature</th> <th>Time</th> </tr> </thead> <tbody> <tr> <td>1</td> <td><math>100</math> to <math>120^\circ\text{C}</math></td> <td>1 min.</td> </tr> <tr> <td>2</td> <td><math>170</math> to <math>200^\circ\text{C}</math></td> <td>1 min.</td> </tr> </tbody> </table>	Step	Temperature	Time	1	$100$ to $120^\circ\text{C}$	1 min.	2	$170$ to $200^\circ\text{C}$	1 min.																		
Step	Temperature	Time																													
1	$100$ to $120^\circ\text{C}$	1 min.																													
2	$170$ to $200^\circ\text{C}$	1 min.																													
14	Appearance	No marking defects	Fix the capacitor to the supporting jig (glass epoxy board) shown in Fig. 4. Perform the 5 cycles according to the 4 heat treatments listed in the following table. Let sit for $24\pm 2$ hrs. at room condition,* then measure.																												
	Capacitance Change	Within $\pm 7.5\%$																													
	D.F.	0.025 max.																													
	I.R.	$C\geq 0.01\mu\text{F}$ : More than $100\text{M}\Omega \cdot \mu\text{F}$ $C < 0.01\mu\text{F}$ : More than $10,000\text{M}\Omega$																													
		<table border="1"> <thead> <tr> <th>Step</th> <th>Temperature (<math>^\circ\text{C}</math>)</th> <th>Time (min.)</th> </tr> </thead> <tbody> <tr> <td>1</td> <td>Min. Operating Temp.<math>\pm 3</math></td> <td><math>30\pm 3</math></td> </tr> <tr> <td>2</td> <td>Room Temp.</td> <td>2 to 3</td> </tr> <tr> <td>3</td> <td>Max. Operating Temp.<math>\pm 2</math></td> <td><math>30\pm 3</math></td> </tr> <tr> <td>4</td> <td>Room Temp.</td> <td>2 to 3</td> </tr> </tbody> </table>	Step	Temperature ( $^\circ\text{C}$ )	Time (min.)	1	Min. Operating Temp. $\pm 3$	$30\pm 3$	2	Room Temp.	2 to 3	3	Max. Operating Temp. $\pm 2$	$30\pm 3$	4	Room Temp.	2 to 3														
Step	Temperature ( $^\circ\text{C}$ )	Time (min.)																													
1	Min. Operating Temp. $\pm 3$	$30\pm 3$																													
2	Room Temp.	2 to 3																													
3	Max. Operating Temp. $\pm 2$	$30\pm 3$																													
4	Room Temp.	2 to 3																													
		•Pretreatment Perform a heat treatment at $150\pm 1^\circ\text{C}$ for $60\pm 5$ min. and then let sit for $24\pm 2$ hrs. at room condition.*   <p style="text-align: center;">Fig. 4</p>																													
15	Appearance	No marking defects	Let the capacitor sit at $40\pm 2^\circ\text{C}$ and relative humidity of 90 to 95% for $500\pm 2$ hrs. Remove and let sit for $24\pm 2$ hrs. at room condition,* then measure. •Pretreatment Perform a heat treatment at $150\pm 1^\circ\text{C}$ for $60\pm 5$ min. and then let sit for $24\pm 2$ hrs. at room condition.*																												
	Capacitance Change	Within $\pm 15\%$																													
	D.F.	0.05 max.																													
	I.R.	$C\geq 0.01\mu\text{F}$ : More than $10\text{M}\Omega \cdot \mu\text{F}$ $C < 0.01\mu\text{F}$ : More than $1,000\text{M}\Omega$																													
		Dielectric Strength In accordance with item No.4																													

\* "Room condition" Temperature: 15 to  $35^\circ\text{C}$ , Relative humidity: 45 to 75%, Atmospheric pressure: 86 to  $106\text{kPa}$

Continued on the following page.

For General Purpose GRM/GRJ/GR3 Series

Only for Applications

AC250V Type GA2 Series

Safety Standard Certified GA3 Series

Product Information

## GRJ Series Specifications and Test Methods

Continued from the preceding page.

No.	Item	Specifications	Test Method								
16	Life	Appearance	Apply voltage as in Table for 1,000±48hrs. at maximum operating temperature ±3°C. Remove and let sit for 24±2 hrs. at room condition,* then measure. <table border="1" style="margin: 5px auto;"> <thead> <tr> <th>Rated Voltage</th> <th>Applied Voltage</th> </tr> </thead> <tbody> <tr> <td>DC250V</td> <td>150% of the rated voltage</td> </tr> <tr> <td>DC630V</td> <td>120% of the rated voltage</td> </tr> <tr> <td>DC1kV</td> <td>110% of the rated voltage</td> </tr> </tbody> </table> The charge/discharge current is less than 50mA. •Pretreatment Apply test voltage for 60±5 min. at test temperature. Remove and let sit for 24±2 hrs. at room condition.*	Rated Voltage	Applied Voltage	DC250V	150% of the rated voltage	DC630V	120% of the rated voltage	DC1kV	110% of the rated voltage
		Rated Voltage		Applied Voltage							
		DC250V		150% of the rated voltage							
		DC630V		120% of the rated voltage							
		DC1kV		110% of the rated voltage							
Capacitance Change	Within ±15% (rated voltage: DC250V, DC630V) Within ±20% (rated voltage: DC1kV)										
D.F.	0.05 max.										
I.R.	C≥0.01μF: More than 10MΩ • μF C<0.01μF: More than 1,000MΩ										
Dielectric Strength	In accordance with item No.4										
17	Humidity Loading (Application: DC250V, DC630V item)	Appearance	Apply the rated voltage at 40±2°C and relative humidity of 90 to 95% for 500±24hrs. Remove and let sit for 24±2 hrs. at room condition,* then measure. •Pretreatment Apply test voltage for 60±5 min. at test temperature. Remove and let sit for 24±2 hrs. at room condition.*								
		Capacitance Change		Within ±15%							
		D.F.		0.05 max.							
		I.R.		C≥0.01μF: More than 10MΩ • μF C<0.01μF: More than 1,000MΩ							
		Dielectric Strength		In accordance with item No.4							

\* "Room condition" Temperature: 15 to 35°C, Relative humidity: 45 to 75%, Atmospheric pressure: 86 to 106kPa

For General Purpose GRM/GRU/GR3 Series

Only for Applications

AC250V Type GA2 Series

Safety Standard Certified GA3 Series

Product Information



## Chip Monolithic Ceramic Capacitors (Medium Voltage)

# Large Capacitance and High Allowable Ripple Current GR3 Series

**Anti-noise**

### ■ Features

1. This series can provide higher capacitance value under DC-Bias condition, compare with previous X7R char.
2. Improve the performance of ripple-resistance compared with X7R char.
3. Reduce acoustic noise.
4. High reliability for board bending stress
5. Sn-plated external electrodes provide good soldering, and other types with reflow soldering only.
6. Use the GR321/331 types with flow or reflow soldering, and other types with reflow soldering only.

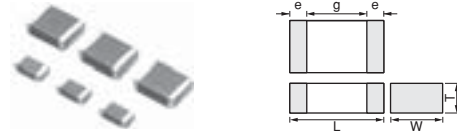

Part Number	Dimensions (mm)					
	L	W	T	e	g min.	
GR321A	2.0±0.2	1.25±0.2	1.0+0,-0.3	0.3 min.	0.7	
GR321B			1.25±0.2			
GR331A	3.2±0.2	1.6±0.2	1.0+0,-0.3		1.2	
GR331B			1.25+0,-0.3			
GR331C			1.6±0.2			
GR332Q			1.5+0,-0.3			
GR332D	3.2±0.3	2.5±0.2	2.0+0,-0.3			2.2
GR343Q	4.5±0.4	3.2±0.3	1.5+0,-0.3			
GR343D	5.7±0.4	5.0±0.4	2.0+0,-0.3		3.2	
GR355D			2.0+0,-0.3			
GR355X			2.7+0,-0.3			

### ■ Applications

1. DC smoothing & EMI filter for LED Lighting.
2. For PFC circuit in the switching power supplies, AC adaptor.
3. DC-DC converter for general electronic equipment.

Do not use these products in any Automotive Power train or Safety equipment including Battery chargers for Electric Vehicles and Plug-in Hybrids. Only Murata products clearly stipulated as "for Automotive use" can be used for automobile applications such as Power train and Safety equipment.

Part Number	Rated Voltage	TC Code (Standard)	Capacitance	Length L (mm)	Width W (mm)	Thickness T max. (mm)	Electrode g min.	Electrode e
GR321AD72E103KW01D	250Vdc	X7T (EIA)	10000pF±10%	2	1.25	1	0.7mm	0.3mm min.
GR321AD72E153KW01D	250Vdc	X7T (EIA)	15000pF±10%	2	1.25	1	0.7mm	0.3mm min.
GR321BD72E223KW03L	250Vdc	X7T (EIA)	22000pF±10%	2	1.25	1.45	0.7mm	0.3mm min.
GR331AD72E333KW01D	250Vdc	X7T (EIA)	33000pF±10%	3.2	1.6	1	1.2mm	0.3mm min.
GR331BD72E473KW01L	250Vdc	X7T (EIA)	47000pF±10%	3.2	1.6	1.25	1.2mm	0.3mm min.
GR331CD72E683KW03L	250Vdc	X7T (EIA)	68000pF±10%	3.2	1.6	1.8	1.2mm	0.3mm min.
GR332QD72E104KW01L	250Vdc	X7T (EIA)	0.10µF±10%	3.2	2.5	1.5	1.2mm	0.3mm min.
GR332DD72E154KW01L	250Vdc	X7T (EIA)	0.15µF±10%	3.2	2.5	2	1.2mm	0.3mm min.
GR343QD72E224KW01L	250Vdc	X7T (EIA)	0.22µF±10%	4.5	3.2	1.5	2.2mm	0.3mm min.
GR343DD72E334KW01L	250Vdc	X7T (EIA)	0.33µF±10%	4.5	3.2	2	2.2mm	0.3mm min.
GR355DD72E474KW01L	250Vdc	X7T (EIA)	0.47µF±10%	5.7	5.0	2	3.2mm	0.3mm min.
GR355DD72E684KW01L	250Vdc	X7T (EIA)	0.68µF±10%	5.7	5.0	2	3.2mm	0.3mm min.
GR355XD72E105KW05L	250Vdc	X7T (EIA)	1.0µF±10%	5.7	5.0	2.7	3.2mm	0.3mm min.
GR331AD72W103KW01D	450Vdc	X7T (EIA)	10000pF±10%	3.2	1.6	1	1.2mm	0.3mm min.
GR331AD72W153KW01D	450Vdc	X7T (EIA)	15000pF±10%	3.2	1.6	1	1.2mm	0.3mm min.
GR331BD72W223KW01L	450Vdc	X7T (EIA)	22000pF±10%	3.2	1.6	1.25	1.2mm	0.3mm min.
GR331BD72W333KW01L	450Vdc	X7T (EIA)	33000pF±10%	3.2	1.6	1.25	1.2mm	0.3mm min.
GR331CD72W473KW03L	450Vdc	X7T (EIA)	47000pF±10%	3.2	1.6	1.8	1.2mm	0.3mm min.
GR332DD72W683KW01L	450Vdc	X7T (EIA)	68000pF±10%	3.2	2.5	2	1.2mm	0.3mm min.
GR332DD72W104KW01L	450Vdc	X7T (EIA)	0.10µF±10%	3.2	2.5	2	1.2mm	0.3mm min.
GR343DD72W154KW01L	450Vdc	X7T (EIA)	0.15µF±10%	4.5	3.2	2	2.2mm	0.3mm min.
GR355DD72W224KW01L	450Vdc	X7T (EIA)	0.22µF±10%	5.7	5.0	2	3.2mm	0.3mm min.
GR355DD72W334KW01L	450Vdc	X7T (EIA)	0.33µF±10%	5.7	5.0	2	3.2mm	0.3mm min.
GR355DD72W474KW01L	450Vdc	X7T (EIA)	0.47µF±10%	5.7	5.0	2	3.2mm	0.3mm min.
GR355XD72W564KW05L	450Vdc	X7T (EIA)	0.56µF±10%	5.7	5.0	2.7	3.2mm	0.3mm min.

Continued on the following page.

Continued from the preceding page.

Part Number	Rated Voltage	TC Code (Standard)	Capacitance	Length L (mm)	Width W (mm)	Thickness T max. (mm)	Electrode g min.	Electrode e
GR331BD72J103KW01L	630Vdc	X7T (EIA)	10000pF±10%	3.2	1.6	1.25	1.2mm	0.3mm min.
GR331CD72J153KW03L	630Vdc	X7T (EIA)	15000pF±10%	3.2	1.6	1.8	1.2mm	0.3mm min.
GR332QD72J223KW01L	630Vdc	X7T (EIA)	22000pF±10%	3.2	2.5	1.5	1.2mm	0.3mm min.
GR332DD72J333KW01L	630Vdc	X7T (EIA)	33000pF±10%	3.2	2.5	2	1.2mm	0.3mm min.
GR332DD72J473KW01L	630Vdc	X7T (EIA)	47000pF±10%	3.2	2.5	2	1.2mm	0.3mm min.
GR343DD72J683KW01L	630Vdc	X7T (EIA)	68000pF±10%	4.5	3.2	2	2.2mm	0.3mm min.
GR355DD72J104KW01L	630Vdc	X7T (EIA)	0.1μF±10%	5.7	5.0	2	3.2mm	0.3mm min.
GR355DD72J154KW01L	630Vdc	X7T (EIA)	0.15μF±10%	5.7	5.0	2	3.2mm	0.3mm min.
GR355XD72J224KW05L	630Vdc	X7T (EIA)	0.22μF±10%	5.7	5.0	2.7	3.2mm	0.3mm min.
GR355XD72J274KW05L	630Vdc	X7T (EIA)	0.27μF±10%	5.7	5.0	2.7	3.2mm	0.3mm min.

For General Purpose GRM/GRU/GR3 Series

Only for Applications

AC250V Type GA2 Series

Safety Standard Certified GA3 Series

Product Information

## GR3 Series Specifications and Test Methods

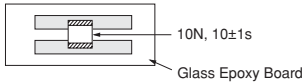
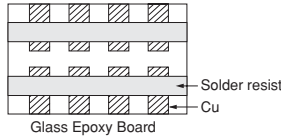
No.	Item	Specifications	Test Method												
1	Operating Temperature Range	-55 to +125°C	-												
2	Appearance	No defects or abnormalities	Visual inspection												
3	Dimensions	Within the specified dimensions	Using calipers and micrometers												
4	Dielectric Strength	No defects or abnormalities	<p>No failure should be observed when voltage in Table is applied between the terminations for 1 to 5 sec., provided the charge/discharge current is less than 50mA.</p> <table border="1"> <thead> <tr> <th>Rated Voltage</th> <th>Test Voltage</th> </tr> </thead> <tbody> <tr> <td>DC250V</td> <td>200% of the rated voltage</td> </tr> <tr> <td>DC450V</td> <td>150% of the rated voltage</td> </tr> <tr> <td>DC630V</td> <td>120% of the rated voltage</td> </tr> </tbody> </table>	Rated Voltage	Test Voltage	DC250V	200% of the rated voltage	DC450V	150% of the rated voltage	DC630V	120% of the rated voltage				
Rated Voltage	Test Voltage														
DC250V	200% of the rated voltage														
DC450V	150% of the rated voltage														
DC630V	120% of the rated voltage														
5	Insulation Resistance (I.R.)	More than 10,000MΩ or 100MΩ • μF (Whichever is smaller)	The insulation resistance should be measured with DC500±50V (DC250±25V in case of rated voltage: DC250V, DC450V) and within 60±5 sec. of charging.												
6	Capacitance	Within the specified tolerance	The capacitance/D.F. should be measured at a frequency of 1±0.2kHz and a voltage of AC1±0.2V(r.m.s.).												
7	Dissipation Factor (D.F.)	0.01 max.													
8	Capacitance Temperature Characteristics	Cap. Change Within ±3% (Temp. Range: -55 to +125°C)	<p>The capacitance measurement should be made at each step specified in the Table.</p> <table border="1"> <thead> <tr> <th>Step</th> <th>Temperature (°C)</th> </tr> </thead> <tbody> <tr> <td>1</td> <td>25±2</td> </tr> <tr> <td>2</td> <td>Min. Operating Temp.±3</td> </tr> <tr> <td>3</td> <td>25±2</td> </tr> <tr> <td>4</td> <td>Max. Operating Temp.±2</td> </tr> <tr> <td>5</td> <td>25±2</td> </tr> </tbody> </table> <p>•Pretreatment                      Perform a heat treatment at 150±9°C for 60±5 min. and then let sit for 24±2 hrs. at room condition.*</p>	Step	Temperature (°C)	1	25±2	2	Min. Operating Temp.±3	3	25±2	4	Max. Operating Temp.±2	5	25±2
Step	Temperature (°C)														
1	25±2														
2	Min. Operating Temp.±3														
3	25±2														
4	Max. Operating Temp.±2														
5	25±2														
9	Adhesive Strength of Termination	No removal of the terminations or other defect should occur.	<p>Solder the capacitor to the testing jig (glass epoxy board) shown in Fig. 1.                      Then apply 10N force in the direction of the arrow.                      The soldering should be done using the reflow method and should be conducted with care so that the soldering is uniform and free of defects such as heat shock.</p>  <p style="text-align: center;">Fig. 1</p>												
10	Vibration Resistance	Appearance	No defects or abnormalities												
		Capacitance	Within the specified tolerance												
		D.F.	0.01 max.												
			<p>Solder the capacitor to the test jig (glass epoxy board). The capacitor should be subjected to a simple harmonic motion having a total amplitude of 1.5mm, the frequency being varied uniformly between the approximate limits of 10 and 55Hz. The frequency range, from 10 to 55Hz and return to 10Hz, should be traversed in approximately 1 min. This motion should be applied for a period of 2 hrs. in each of 3 mutually perpendicular directions (total of 6 hrs.).</p> 												

\* "Room condition" Temperature: 15 to 35°C, Relative humidity: 45 to 75%, Atmospheric pressure: 86 to 106kPa

Continued on the following page.

For General Purpose GRM/GRJ/GR3 Series

Only for Applications

AC250V Type GA2 Series

Safety Standard Certified GA3 Series

Product Information

# GR3 Series Specifications and Test Methods

Continued from the preceding page.

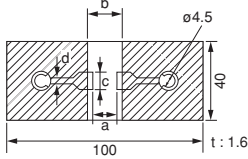
No.	Item	Specifications	Test Method																												
11	Deflection	No marking defects	Solder the capacitor to the testing jig (glass epoxy board) shown in Fig. 2. Then apply a force in the direction shown in Fig. 3. The soldering should be done using the reflow method and should be conducted with care so that the soldering is uniform and free of defects such as heat shock.																												
		 <p>Fig. 2</p> <table border="1"> <thead> <tr> <th>L×W (mm)</th> <th colspan="4">Dimension (mm)</th> </tr> <tr> <th></th> <th>a</th> <th>b</th> <th>c</th> <th>d</th> </tr> </thead> <tbody> <tr> <td>2.0×1.25</td> <td>1.2</td> <td>4.0</td> <td>1.65</td> <td rowspan="6">1.0</td> </tr> <tr> <td>3.2×1.6</td> <td>2.2</td> <td>5.0</td> <td>2.0</td> </tr> <tr> <td>3.2×2.5</td> <td>2.2</td> <td>5.0</td> <td>2.9</td> </tr> <tr> <td>4.5×3.2</td> <td>3.5</td> <td>7.0</td> <td>3.7</td> </tr> <tr> <td>5.7×5.0</td> <td>4.5</td> <td>8.0</td> <td>5.6</td> </tr> </tbody> </table>		L×W (mm)	Dimension (mm)					a	b	c	d	2.0×1.25	1.2	4.0	1.65	1.0	3.2×1.6	2.2	5.0	2.0	3.2×2.5	2.2	5.0	2.9	4.5×3.2	3.5	7.0	3.7	5.7×5.0
L×W (mm)	Dimension (mm)																														
	a	b	c	d																											
2.0×1.25	1.2	4.0	1.65	1.0																											
3.2×1.6	2.2	5.0	2.0																												
3.2×2.5	2.2	5.0	2.9																												
4.5×3.2	3.5	7.0	3.7																												
5.7×5.0	4.5	8.0	5.6																												
12	Solderability of Termination	75% of the terminations are to be soldered evenly and continuously.	Immerse the capacitor in a solution of ethanol (JIS-K-8101) and rosin (JIS-K-5902) (25% rosin in weight proportion). Immerse in solder solution for 2±0.5 sec. Immersing speed: 25±2.5mm/s Temp. of solder: 245±5°C Lead Free Solder (Sn-3.0Ag-0.5Cu) 235±5°C H60A or H63A Eutectic Solder																												
13	Resistance to Soldering Heat	Appearance	No marking defects	Preheat the capacitor at 120 to 150°C* for 1 min. Immerse the capacitor in solder solution at 260±5°C for 10±1 sec. Let sit at room condition* for 24±2 hrs., then measure. •Immersing speed: 25±2.5mm/s •Pretreatment Perform a heat treatment at 150±10°C for 60±5 min. and then let sit for 24±2 hrs. at room condition.*  *Preheating for more than 3.2×2.5mm																											
		Capacitance Change	Within ±10%																												
		D.F.	0.01 max.																												
		I.R.	More than 10,000MΩ or 100MΩ • μF (Whichever is smaller)																												
		Dielectric Strength	In accordance with item No.4																												
14	Temperature Cycle	Appearance	No marking defects	Fix the capacitor to the supporting jig (glass epoxy board) shown in Fig. 4. Perform the 5 cycles according to the 4 heat treatments listed in the following table. Let sit for 24±2 hrs. at room condition,* then measure.																											
		Capacitance Change	Within ±7.5%																												
		D.F.	0.01 max.																												
		I.R.	More than 10,000MΩ or 100MΩ • μF (Whichever is smaller)																												
		Dielectric Strength	In accordance with item No.4																												
15	Humidity (Steady State)	Appearance	No marking defects	Let the capacitor sit at 40±2°C and relative humidity of 90 to 95% for 500±24hrs. Remove and let sit for 24±2 hrs. at room condition,* then measure. •Pretreatment Perform a heat treatment at 150±10°C for 60±5 min. and then let sit for 24±2 hrs. at room condition.*																											
		Capacitance Change	Within ±12.5%																												
		D.F.	0.02 max.																												
		I.R.	More than 1,000MΩ or 10MΩ • μF (Whichever is smaller)																												
		Dielectric Strength	In accordance with item No.4																												

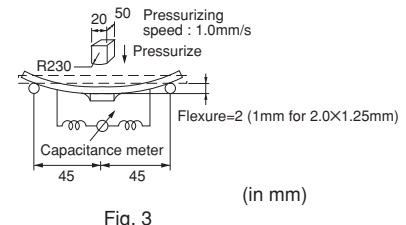

Step	Temperature	Time
1	100 to 120°C	1 min.
2	170 to 200°C	1 min.

Step	Temperature (°C)	Time (min.)
1	Min. Operating Temp. +5	30±3
2	Room Temp.	2 to 3
3	Max. Operating Temp. +5	30±3
4	Room Temp.	2 to 3

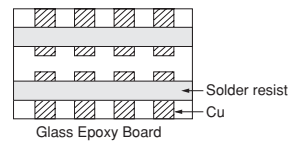

\* "Room condition" Temperature: 15 to 35°C, Relative humidity: 45 to 75%, Atmospheric pressure: 86 to 106kPa

Continued on the following page. ↗

For General Purpose GRM/GRU/GR3 Series  
 Only for Applications  
 AC250V Type GA2 Series  
 Safety Standard Certified GA3 Series  
 Product Information

## GR3 Series Specifications and Test Methods

↳ Continued from the preceding page.

No.	Item	Specifications	Test Method									
16	Life	Appearance	No marking defects	Apply voltage as Table for 1,000 <sup>±4</sup> hrs. at maximum operating temperature ±3°C. Remove and let sit for 24±2hrs. at room condition,* then measure. <table border="1" style="margin: 5px auto; border-collapse: collapse;"> <thead> <tr style="background-color: #f2f2f2;"> <th style="font-size: small;">Rated Voltage</th> <th style="font-size: small;">Applied Voltage</th> </tr> </thead> <tbody> <tr> <td style="text-align: center;">DC250V</td> <td style="text-align: center;">150% of the rated voltage</td> </tr> <tr> <td style="text-align: center;">DC450V</td> <td style="text-align: center;">130% of the rated voltage</td> </tr> <tr> <td style="text-align: center;">DC630V</td> <td style="text-align: center;">120% of the rated voltage</td> </tr> </tbody> </table>	Rated Voltage	Applied Voltage	DC250V	150% of the rated voltage	DC450V	130% of the rated voltage	DC630V	120% of the rated voltage
		Rated Voltage	Applied Voltage									
		DC250V	150% of the rated voltage									
		DC450V	130% of the rated voltage									
		DC630V	120% of the rated voltage									
Capacitance Change	Within ±12.5%											
D.F.	0.02 max.											
I.R.	More than 1,000MΩ or 10MΩ • μF (Whichever is smaller)											
Dielectric Strength	In accordance with item No.4	The charge/discharge current is less than 50mA. •Pretreatment Apply test voltage for 60±5 min. at test temperature. Remove and let sit for 24±2 hrs. at room condition.*										
17	Humidity Loading	Appearance	No marking defects	Apply the rated voltage at 40±2°C and relative humidity of 90 to 95% for 500 <sup>±2</sup> hrs. Remove and let sit for 24±2 hrs. at room condition,* then measure. •Pretreatment Apply test voltage for 60±5 min. at test temperature. Remove and let sit for 24±2 hrs. at room condition.*								
		Capacitance Change	Within ±12.5%									
		D.F.	0.02 max.									
		I.R.	More than 1,000MΩ or 10MΩ • μF (Whichever is smaller)									
		Dielectric Strength	In accordance with item No.4									

\* "Room condition" Temperature: 15 to 35°C, Relative humidity: 45 to 75%, Atmospheric pressure: 86 to 106kPa

For General Purpose  
GRM/GRJ/GR3 Series

Only for Applications

AC250V Type  
GA2 Series

Safety Standard  
Certified GA3 Series

Product Information

## Chip Monolithic Ceramic Capacitors (Medium Voltage)

# For LCD Backlight Inverter Circuit GRM/DC3.15kV Series

### ■ Features

1. Low-loss and suitable for high frequency circuits
2. Murata's original internal electrode structure realizes high flash-over voltage.
3. A new monolithic structure for small, surface-mountable devices capable of operating at high voltage levels.
4. Sn-plated external electrodes realize good solderability.
5. Only for reflow soldering
6. Capacitance values less than 22pF can be used in LCD backlight inverter circuits as long as the applied voltage, peak to peak, is less than 4.0kV at 100kHz or less.

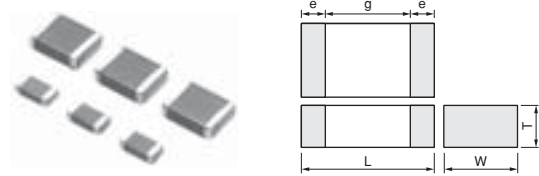

Part Number	Dimensions (mm)				
	L	W	T	e min.	g min.
GRM42A	4.5 ±0.3	2.0 ±0.2	1.0 +0, -0.3	0.3	2.9

### ■ Applications

Ideal for use as the ballast in LCD backlight inverter.

Do not use these products in any Automotive Power train or Safety equipment including Battery chargers for Electric Vehicles and Plug-in Hybrids. Only Murata products clearly stipulated as "for Automotive use" can be used for automobile applications such as Power train and Safety equipment.

Part Number	Rated Voltage	TC Code (Standard)	Capacitance	Length L (mm)	Width W (mm)	Thickness T max. (mm)	Electrode g min.	Electrode e
GRM42A5C3F050DW01L	3150Vdc	C0G (EIA)	5.0pF±0.5pF	4.5	2.0	1	2.9mm	0.3mm min.
GRM42A5C3F100JW01L	3150Vdc	C0G (EIA)	10pF±5%	4.5	2.0	1	2.9mm	0.3mm min.
GRM42A5C3F120JW01L	3150Vdc	C0G (EIA)	12pF±5%	4.5	2.0	1	2.9mm	0.3mm min.
GRM42A5C3F150JW01L	3150Vdc	C0G (EIA)	15pF±5%	4.5	2.0	1	2.9mm	0.3mm min.
GRM42A5C3F180JW01L	3150Vdc	C0G (EIA)	18pF±5%	4.5	2.0	1	2.9mm	0.3mm min.
GRM42A5C3F220JW01L	3150Vdc	C0G (EIA)	22pF±5%	4.5	2.0	1	2.9mm	0.3mm min.
GRM42A5C3F270JW01L	3150Vdc	C0G (EIA)	27pF±5%	4.5	2.0	1	2.9mm	0.3mm min.
GRM42A5C3F330JW01L	3150Vdc	C0G (EIA)	33pF±5%	4.5	2.0	1	2.9mm	0.3mm min.
GRM42A5C3F390JW01L	3150Vdc	C0G (EIA)	39pF±5%	4.5	2.0	1	2.9mm	0.3mm min.
GRM42A5C3F470JW01L	3150Vdc	C0G (EIA)	47pF±5%	4.5	2.0	1	2.9mm	0.3mm min.

For General Purpose GRM/GRU/GR3 Series  
 Only for Applications GRM/DC3.15kV Series  
 AC250V Type GA2 Series  
 Safety Standard Certified GA3 Series  
 Product Information

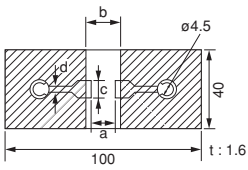
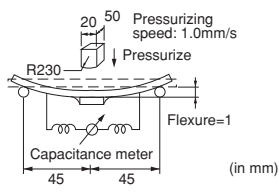

## GRM/DC3.15kV Series Specifications and Test Methods

No.	Item	Specifications	Test Method														
1	Operating Temperature Range	-55 to +125°C	-														
2	Appearance	No defects or abnormalities	Visual inspection														
3	Dimensions	Within the specified dimension	Using calipers and micrometers														
4	Dielectric Strength	No defects or abnormalities	No failure should be observed when DC4095V is applied between the terminations for 1 to 5 sec., provided the charge/discharge current is less than 50mA.														
5	Insulation Resistance (I.R.)	More than 10,000MΩ	The insulation resistance should be measured with DC500±50V and within 60±5 sec. of charging.														
6	Capacitance	Within the specified tolerance	The capacitance/Q should be measured at a frequency of 1±0.2MHz and a voltage of AC0.5 to 5V(r.m.s.).														
7	Q	1,000 min.															
8	Capacitance Temperature Characteristics	Temp. Coefficient 0±30ppm/°C (Temp. Range: +25 to +125°C) 0+30, -72ppm/°C (Temp. Range: -55 to +25°C)	The capacitance measurement should be made at each step specified in the Table.														
			<table border="1" style="margin: auto; border-collapse: collapse;"> <thead> <tr> <th style="width: 15%;">Step</th> <th style="width: 85%;">Temperature (°C)</th> </tr> </thead> <tbody> <tr> <td style="text-align: center;">1</td> <td style="text-align: center;">25±2</td> </tr> <tr> <td style="text-align: center;">2</td> <td style="text-align: center;">Min. Operating Temp.±3</td> </tr> <tr> <td style="text-align: center;">3</td> <td style="text-align: center;">25±2</td> </tr> <tr> <td style="text-align: center;">4</td> <td style="text-align: center;">Max. Operating Temp.±2</td> </tr> <tr> <td style="text-align: center;">5</td> <td style="text-align: center;">25±2</td> </tr> </tbody> </table>	Step	Temperature (°C)	1	25±2	2	Min. Operating Temp.±3	3	25±2	4	Max. Operating Temp.±2	5	25±2		
Step	Temperature (°C)																
1	25±2																
2	Min. Operating Temp.±3																
3	25±2																
4	Max. Operating Temp.±2																
5	25±2																
9	Adhesive Strength of Termination	No removal of the terminations or other defect should occur.	Solder the capacitor to the testing jig (glass epoxy board) shown in Fig. 1. Then apply 10N force in the direction of the arrow. The soldering should be done using the reflow method and should be conducted with care so that the soldering is uniform and free of defects such as heat shock.														
10	Vibration Resistance	Appearance	No defects or abnormalities														
		Capacitance	Within the specified tolerance														
		Q	1,000 min.														
11	Deflection	No marking defects	Solder the capacitor to the testing jig (glass epoxy board) shown in Fig. 2. Then apply a force in the direction shown in Fig. 3. The soldering should be done using the reflow method and should be conducted with care so that the soldering is uniform and free of defects such as heat shock.														
		 <p style="text-align: center;">Fig. 2</p> <table border="1" style="margin: auto; border-collapse: collapse; text-align: center;"> <thead> <tr> <th rowspan="2">L×W (mm)</th> <th colspan="4">Dimension (mm)</th> </tr> <tr> <th>a</th> <th>b</th> <th>c</th> <th>d</th> </tr> </thead> <tbody> <tr> <td>4.5×2.0</td> <td>3.5</td> <td>7.0</td> <td>2.4</td> <td>1.0</td> </tr> </tbody> </table>		L×W (mm)	Dimension (mm)				a	b	c	d	4.5×2.0	3.5	7.0	2.4	1.0
		L×W (mm)			Dimension (mm)												
a	b		c	d													
4.5×2.0	3.5	7.0	2.4	1.0													
 <p style="text-align: center;">Fig. 3</p>																	

Continued on the following page. ↗

For General Purpose GRM/GRJ/GR3 Series

Only for Applications GRM/DC3.15kV Series

AC250V Type GA2 Series

Safety Standard Certified GA3 Series

Product Information

## GRM/DC3.15kV Series Specifications and Test Methods

Continued from the preceding page.

No.	Item	Specifications	Test Method
12	Solderability of Termination	75% of the terminations are to be soldered evenly and continuously.	Immerse the capacitor in a solution of ethanol (JIS-K-8101) and rosin (JIS-K-5902) (25% rosin in weight proportion). Immerse in solder solution for 2±0.5 sec. Immersing speed: 25±2.5mm/s Temp. of solder: 245±5°C Lead Free Solder (Sn-3.0Ag-0.5Cu) 235±5°C H60A or H63A Eutectic Solder
13	Resistance to Soldering Heat	Appearance	No marking defects
		Capacitance Change	Within ±2.5%
		Q	1,000 min.
		I.R.	More than 10,000MΩ
14	Temperature Cycle	Appearance	No marking defects
		Capacitance Change	Within ±2.5%
		Q	1,000 min.
		I.R.	More than 10,000MΩ
15	Humidity (Steady State)	Appearance	No marking defects
		Capacitance Change	Within ±5.0%
		Q	350 min.
		I.R.	More than 1,000MΩ
16	Life	Appearance	No marking defects
		Capacitance Change	Within ±3.0%
		Q	350 min.
		I.R.	More than 1,000MΩ
17	Dielectric Strength	Appearance	No marking defects
		Capacitance Change	Within ±2.5%
		Q	1,000 min.
		I.R.	More than 10,000MΩ

**\*Preheating**

Step	Temperature	Time
1	100 to 120°C	1 min.
2	170 to 200°C	1 min.

Fix the capacitor to the supporting jig (glass epoxy board) shown in Fig. 4.  
 Perform the 5 cycles according to the 4 heat treatments listed in the following table.  
 Let sit for 24±2 hrs. at room condition,\* then measure.

Step	Temperature (°C)	Time (min.)
1	Min. Operating Temp.±3	30±3
2	Room Temp.	2 to 3
3	Max. Operating Temp.±2	30±3
4	Room Temp.	2 to 3

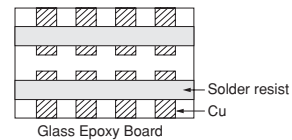

Fig. 4

Let the capacitor sit at 40±2°C and relative humidity of 90 to 95% for 500<sup>+24</sup>hrs.  
 Remove and let sit for 24±2 hrs. at room condition,\* then measure.

Apply 120% of the rated voltage for 1,000<sup>+48</sup>hrs. at maximum operating temperature ±3°C.  
 Remove and let sit for 24±2 hrs. at room condition,\* then measure.  
 The charge/discharge current is less than 50mA.

\* "Room condition" Temperature: 15 to 35°C, Relative humidity: 45 to 75%, Atmospheric pressure: 86 to 106kPa

For General Purpose GRM/GRU/GR3 Series  
 Only for Applications GRM/DC3.15kV Series  
 AC250V Type GA2 Series  
 Safety Standard Certified GA3 Series  
 Product Information

## Chip Monolithic Ceramic Capacitors (Medium Voltage)

# For Information Devices GR4 Series

### ■ Features

1. These items are designed specifically for telecommunications devices (IEEE802.3) in Ethernet LAN and primary-secondary coupling for DC-DC converters.
2. A new monolithic structure for small, high capacitance capable of operating at high voltage levels
3. Sn-plated external electrodes realize good solderability.
4. Only for reflow soldering

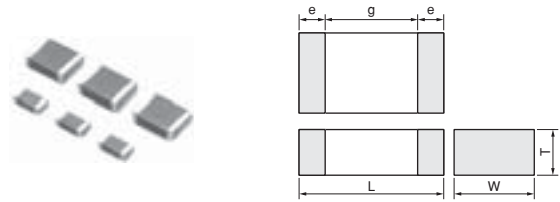

Part Number	Dimensions (mm)				
	L	W	T	e min.	g min.
GR442Q	4.5 ±0.3	2.0 ±0.2	1.5 +0, -0.3	0.3	2.5
GR443D	4.5 ±0.4	3.2 ±0.3	2.0 +0, -0.3		
GR443Q			1.5 +0, -0.3		
GR455D	5.7 ±0.4	5.0 ±0.4	2.0 +0, -0.3		3.2

### ■ Applications

1. Ideal for use on telecommunications devices in Ethernet LAN
2. Ideal for use as primary-secondary coupling for DC-DC converters

Do not use these products in any Automotive Power train or Safety equipment including Battery charger for Electric Vehicles and Plug-in Hybrid. Only Murata products clearly stipulated as "for Automotive use" can be used for automobile applications such as Power train and Safety equipment.

Part Number	Rated Voltage	TC Code (Standard)	Capacitance	Length L (mm)	Width W (mm)	Thickness T max. (mm)	Electrode g min.	Electrode e
GR442QR73D101KW01L	2000Vdc	X7R (EIA)	100pF±10%	4.5	2	1.5	2.5mm	0.3mm min.
GR442QR73D121KW01L	2000Vdc	X7R (EIA)	120pF±10%	4.5	2	1.5	2.5mm	0.3mm min.
GR442QR73D151KW01L	2000Vdc	X7R (EIA)	150pF±10%	4.5	2	1.5	2.5mm	0.3mm min.
GR442QR73D181KW01L	2000Vdc	X7R (EIA)	180pF±10%	4.5	2	1.5	2.5mm	0.3mm min.
GR442QR73D221KW01L	2000Vdc	X7R (EIA)	220pF±10%	4.5	2	1.5	2.5mm	0.3mm min.
GR442QR73D271KW01L	2000Vdc	X7R (EIA)	270pF±10%	4.5	2	1.5	2.5mm	0.3mm min.
GR442QR73D331KW01L	2000Vdc	X7R (EIA)	330pF±10%	4.5	2	1.5	2.5mm	0.3mm min.
GR442QR73D391KW01L	2000Vdc	X7R (EIA)	390pF±10%	4.5	2	1.5	2.5mm	0.3mm min.
GR442QR73D471KW01L	2000Vdc	X7R (EIA)	470pF±10%	4.5	2	1.5	2.5mm	0.3mm min.
GR442QR73D561KW01L	2000Vdc	X7R (EIA)	560pF±10%	4.5	2	1.5	2.5mm	0.3mm min.
GR442QR73D681KW01L	2000Vdc	X7R (EIA)	680pF±10%	4.5	2	1.5	2.5mm	0.3mm min.
GR442QR73D821KW01L	2000Vdc	X7R (EIA)	820pF±10%	4.5	2	1.5	2.5mm	0.3mm min.
GR442QR73D102KW01L	2000Vdc	X7R (EIA)	1000pF±10%	4.5	2	1.5	2.5mm	0.3mm min.
GR442QR73D122KW01L	2000Vdc	X7R (EIA)	1200pF±10%	4.5	2	1.5	2.5mm	0.3mm min.
GR442QR73D152KW01L	2000Vdc	X7R (EIA)	1500pF±10%	4.5	2	1.5	2.5mm	0.3mm min.
GR443QR73D182KW01L	2000Vdc	X7R (EIA)	1800pF±10%	4.5	3.2	1.5	2.5mm	0.3mm min.
GR443QR73D222KW01L	2000Vdc	X7R (EIA)	2200pF±10%	4.5	3.2	1.5	2.5mm	0.3mm min.
GR443QR73D272KW01L	2000Vdc	X7R (EIA)	2700pF±10%	4.5	3.2	1.5	2.5mm	0.3mm min.
GR443QR73D332KW01L	2000Vdc	X7R (EIA)	3300pF±10%	4.5	3.2	1.5	2.5mm	0.3mm min.
GR443QR73D392KW01L	2000Vdc	X7R (EIA)	3900pF±10%	4.5	3.2	1.5	2.5mm	0.3mm min.
GR443DR73D472KW01L	2000Vdc	X7R (EIA)	4700pF±10%	4.5	3.2	2	2.5mm	0.3mm min.
GR455DR73D103KW01L	2000Vdc	X7R (EIA)	10000pF±10%	5.7	5	2	3.2mm	0.3mm min.

For General Purpose  
GRW/GRJ/GR3 Series

Only for Applications  
GR4 Series

AC250V Type  
GA2 Series

Safety Standard  
Certified GA3 Series

Product Information

## GR4 Series Specifications and Test Methods

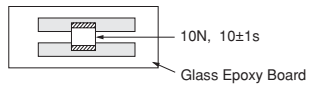
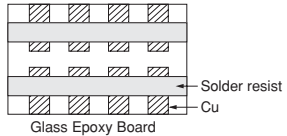
No.	Item	Specifications	Test Method									
1	Operating Temperature Range	-55 to +125°C	-									
2	Appearance	No defects or abnormalities	Visual inspection									
3	Dimensions	Within the specified dimensions	Using calipers and micrometers									
4	Dielectric Strength	No defects or abnormalities	No failure should be observed when voltage in the table is applied between the terminations, provided the charge/discharge current is less than 50mA.									
			<table border="1"> <thead> <tr> <th>Rated Voltage</th> <th>Test Voltage</th> <th>Time</th> </tr> </thead> <tbody> <tr> <td rowspan="2">DC2kV</td> <td>120% of the rated voltage</td> <td>60±1 sec.</td> </tr> <tr> <td>AC1500V(r.m.s.)</td> <td>60±1 sec.</td> </tr> </tbody> </table>	Rated Voltage	Test Voltage	Time	DC2kV	120% of the rated voltage	60±1 sec.	AC1500V(r.m.s.)	60±1 sec.	
Rated Voltage	Test Voltage	Time										
DC2kV	120% of the rated voltage	60±1 sec.										
	AC1500V(r.m.s.)	60±1 sec.										
5	Pulse Voltage	No self healing breakdowns or flash-overs have taken place in the capacitor.	10 impulses of alternating polarity are subjected. (5 impulses for each polarity) The interval between impulses is 60 sec. Applied Pulse: 1.2/50µs Applied Voltage: 2.5kVo-p									
6	Insulation Resistance (I.R.)	More than 6,000MΩ	The insulation resistance should be measured with DC500±50V and within 60±5 sec. of charging.									
7	Capacitance	Within the specified tolerance	The capacitance/D.F. should be measured at a frequency of 1±0.2kHz and a voltage of AC1±0.2V(r.m.s.).									
8	Dissipation Factor (D.F.)	0.025 max.										
9	Capacitance Temperature Characteristics	Cap. Change within ±15% (Temp. Range: -55 to +125°C)	The capacitance measurement should be made at each step specified in the Table.									
			<table border="1"> <thead> <tr> <th>Step</th> <th>Temperature (°C)</th> </tr> </thead> <tbody> <tr> <td>1</td> <td>25±2</td> </tr> <tr> <td>2</td> <td>Min. Operating Temp.±3</td> </tr> <tr> <td>3</td> <td>25±2</td> </tr> <tr> <td>4</td> <td>Max. Operating Temp.±2</td> </tr> <tr> <td>5</td> <td>25±2</td> </tr> </tbody> </table>	Step	Temperature (°C)	1	25±2	2	Min. Operating Temp.±3	3	25±2	4
Step	Temperature (°C)											
1	25±2											
2	Min. Operating Temp.±3											
3	25±2											
4	Max. Operating Temp.±2											
5	25±2											
			<b>•Pretreatment</b> Perform a heat treatment at 150±9°C for 60±5 min. and then let sit for 24±2 hrs. at room condition.*									
10	Adhesive Strength of Termination	No removal of the terminations or other defect should occur.	Solder the capacitor to the testing jig (glass epoxy board) shown in Fig. 1. Then apply 10N force in the direction of the arrow. The soldering should be done using the reflow method and should be conducted with care so that the soldering is uniform and free of defects such as heat shock.									
			 <p>Fig. 1</p>									
11	Vibration Resistance	Appearance	No defects or abnormalities									
		Capacitance	Within the specified tolerance									
		D.F.	0.025 max.									
			Solder the capacitor to the test jig (glass epoxy board). The capacitor should be subjected to a simple harmonic motion having a total amplitude of 1.5mm, the frequency being varied uniformly between the approximate limits of 10 and 55Hz. The frequency range, from 10 to 55Hz and return to 10Hz, should be traversed in approximately 1 min. This motion should be applied for a period of 2 hrs. in each of 3 mutually perpendicular directions (total of 6 hrs.).									
												

\* "Room condition" Temperature: 15 to 35°C, Relative humidity: 45 to 75%, Atmospheric pressure: 86 to 106kPa

Continued on the following page. 

For General Purpose GRM/GRU/GR3 Series  
 Only for Applications GR4 Series  
 AC250V Type GA2 Series  
 Safety Standard Certified GA3 Series  
 Product Information

## GR4 Series Specifications and Test Methods

Continued from the preceding page.

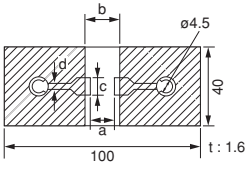
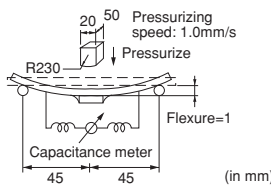
No.	Item	Specifications	Test Method																			
12	Deflection	No marking defects	Solder the capacitor to the testing jig (glass epoxy board) shown in Fig. 2. Then apply a force in the direction shown in Fig. 3. The soldering should be done using the reflow method and should be conducted with care so that the soldering is uniform and free of defects such as heat shock.																			
		 <p style="text-align: center;">Fig. 2</p> <table border="1" style="margin-left: auto; margin-right: auto;"> <thead> <tr> <th rowspan="2">L×W (mm)</th> <th colspan="4">Dimension (mm)</th> </tr> <tr> <th>a</th> <th>b</th> <th>c</th> <th>d</th> </tr> </thead> <tbody> <tr> <td>4.5×2.0</td> <td>3.5</td> <td>7.0</td> <td>2.4</td> <td rowspan="3" style="text-align: center;">1.0</td> </tr> <tr> <td>4.5×3.2</td> <td>3.5</td> <td>7.0</td> <td>3.7</td> </tr> <tr> <td>5.7×5.0</td> <td>4.5</td> <td>8.0</td> <td>5.6</td> </tr> </tbody> </table>		L×W (mm)	Dimension (mm)				a	b	c	d	4.5×2.0	3.5	7.0	2.4	1.0	4.5×3.2	3.5	7.0	3.7	5.7×5.0
L×W (mm)	Dimension (mm)																					
	a	b	c	d																		
4.5×2.0	3.5	7.0	2.4	1.0																		
4.5×3.2	3.5	7.0	3.7																			
5.7×5.0	4.5	8.0	5.6																			
			 <p style="text-align: center;">Fig. 3</p>																			
13	Solderability of Termination	75% of the terminations are to be soldered evenly and continuously.	Immerse the capacitor in a solution of ethanol (JIS-K-8101) and rosin (JIS-K-5902) (25% rosin in weight proportion). Immerse in solder solution for 2±0.5 sec. Immersing speed: 25±2.5mm/s Temp. of solder: 245±5°C Lead Free Solder (Sn-3.0Ag-0.5Cu) 235±5°C H60A or H63A Eutectic Solder																			
14	Resistance to Soldering Heat	Appearance	No marking defects																			
		Capacitance Change	Within ±10%																			
		D.F.	0.025 max.																			
		I.R.	More than 1,000MΩ																			
		Dielectric Strength	In accordance with item No.4																			
15	Temperature Cycle	Appearance	No marking defects																			
		Capacitance Change	Within ±15%																			
		D.F.	0.05 max.																			
		I.R.	More than 3,000MΩ																			
		Dielectric Strength	In accordance with item No.4																			
16	Humidity (Steady State)	Appearance	No marking defects																			
		Capacitance Change	Within ±15%																			
		D.F.	0.05 max.																			
		I.R.	More than 1,000MΩ																			
		Dielectric Strength	In accordance with item No.4																			

\* "Room condition" Temperature: 15 to 35°C, Relative humidity: 45 to 75%, Atmospheric pressure: 86 to 106kPa

Continued on the following page. ↗

For General Purpose GRM/GRJ/GR4 Series

Only for Applications GR4 Series

AC250V Type GA2 Series

Safety Standard Certified GA3 Series

Product Information

## GR4 Series Specifications and Test Methods

↳ Continued from the preceding page.

No.	Item	Specifications	Test Method
17	Life	Appearance	Apply 110% of the rated voltage for $1,000 \pm 48$ hrs. at maximum operating temperature $\pm 3^\circ\text{C}$ . Remove and let sit for $24 \pm 2$ hrs. at room condition,* then measure. The charge/discharge current is less than 50mA. •Pretreatment Apply test voltage for $60 \pm 5$ min. at test temperature. Remove and let sit for $24 \pm 2$ hrs. at room condition.*
		Capacitance Change	
		D.F.	
		I.R.	
		Dielectric Strength	
		No marking defects	
		Within $\pm 20\%$	
		0.05 max.	
		More than 2,000M $\Omega$	
		In accordance with item No.4	

\* "Room condition" Temperature: 15 to 35°C, Relative humidity: 45 to 75%, Atmospheric pressure: 86 to 106kPa

For General Purpose  
GRM/GRJ/GR3 Series

Only for Applications  
GR4 Series

AC250V Type  
GA2 Series

Safety Standard  
Certified GA3 Series

Product Information



## Chip Monolithic Ceramic Capacitors (Medium Voltage)

# For Camera Flash Circuit GR7 Series

### ■ Features

1. Suitable for the trigger of the flash circuit, because real capacitance is stable during operating voltage.
2. The thin type fits thinner cameras.
3. Sn-plated external electrodes realize good solderability.
4. For flow and reflow soldering

### ■ Applications

For strobe circuit

Do not use these products in any Automotive Power train or Safety equipment including Battery chargers for Electric Vehicles and Plug-in Hybrids. Only Murata products clearly stipulated as "for Automotive use" can be used for automobile applications such as Power train and Safety equipment.

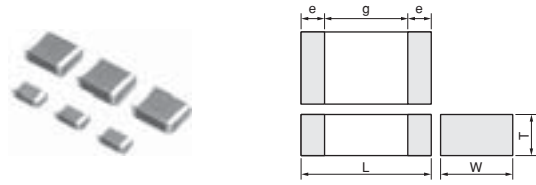

Part Number	Dimensions (mm)				
	L	W	T	e min.	g min.
GR721A	2.0 ±0.2	1.25 ±0.2	1.0 +0, -0.3	0.3	0.7
GR721B			1.25 ±0.2		
GR731A	3.2 ±0.2	1.6 ±0.2	1.0 +0, -0.3		1.2
GR731B			1.25 +0, -0.3		
GR731C			1.6 ±0.2		

Part Number	Rated Voltage	TC Code (Standard)	Capacitance	Length L (mm)	Width W (mm)	Thickness T max. (mm)	Electrode g min.	Electrode e
GR721AW0BB103KW01D	350Vdc	-	10000pF±10%	2	1.25	1	0.7mm	0.3mm min.
GR731AW0BB103KW01D	350Vdc	-	10000pF±10%	3.2	1.6	1	1.2mm	0.3mm min.
GR721AW0BB153KW01D	350Vdc	-	15000pF±10%	2	1.25	1	0.7mm	0.3mm min.
GR731AW0BB153KW01D	350Vdc	-	15000pF±10%	3.2	1.6	1	1.2mm	0.3mm min.
GR721BW0BB223KW03L	350Vdc	-	22000pF±10%	2	1.25	1.45	0.7mm	0.3mm min.
GR731AW0BB223KW01D	350Vdc	-	22000pF±10%	3.2	1.6	1	1.2mm	0.3mm min.
GR731BW0BB223KW01L	350Vdc	-	22000pF±10%	3.2	1.6	1.25	1.2mm	0.3mm min.
GR721BW0BB273KW03L	350Vdc	-	27000pF±10%	2	1.25	1.45	0.7mm	0.3mm min.
GR731AW0BB273KW01D	350Vdc	-	27000pF±10%	3.2	1.6	1	1.2mm	0.3mm min.
GR731AW0BB333KW01D	350Vdc	-	33000pF±10%	3.2	1.6	1	1.2mm	0.3mm min.
GR731BW0BB333KW01L	350Vdc	-	33000pF±10%	3.2	1.6	1.25	1.2mm	0.3mm min.
GR731CW0BB473KW03L	350Vdc	-	47000pF±10%	3.2	1.6	1.8	1.2mm	0.3mm min.

For General Purpose  
 GRW/GRJ/GR3 Series

Only for Applications  
 GR7 Series

AC250V Type  
 GA2 Series

Safety Standard  
 Certified GA3 Series

Product Information

## GR7 Series Specifications and Test Methods

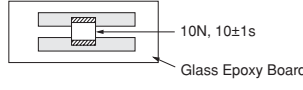
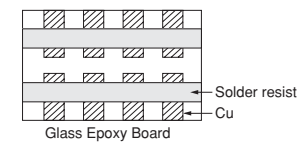
No.	Item	Specifications	Test Method									
1	Operating Temperature Range	-55 to +125°C	-									
2	Appearance	No defects or abnormalities	Visual inspection									
3	Dimensions	Within the specified dimensions	Using calipers and micrometers									
4	Dielectric Strength	No defects or abnormalities	No failure should be observed when DC500V is applied between the terminations for 1 to 5 sec., provided the charge/discharge current is less than 50mA.									
5	Insulation Resistance (I.R.)	C $\geq$ 0.01 $\mu$ F: More than 100M $\Omega$ $\cdot$ $\mu$ F C<0.01 $\mu$ F: More than 10,000M $\Omega$	The insulation resistance should be measured with DC250 $\pm$ 50V and within 60 $\pm$ 5 sec. of charging.									
6	Capacitance	Within the specified tolerance	The capacitance/D.F. should be measured at a frequency of 1 $\pm$ 0.2kHz and a voltage of AC1 $\pm$ 0.2V(r.m.s.).									
7	Dissipation Factor (D.F.)	0.025 max.										
8	Capacitance Temperature Characteristics	Cap. Change Within $\pm$ 10% (Apply DC350V bias) Within $\pm$ 3% (No DC bias) (Temp. Range : -55 to +125°C)	The capacitance measurement should be made at each step specified in the Table.									
			<table border="1"> <thead> <tr> <th>Step</th> <th>Temperature (°C)</th> </tr> </thead> <tbody> <tr> <td>1</td> <td>25<math>\pm</math>2</td> </tr> <tr> <td>2</td> <td>Min. Operating Temp.<math>\pm</math>3</td> </tr> <tr> <td>3</td> <td>25<math>\pm</math>2</td> </tr> <tr> <td>4</td> <td>Max. Operating Temp.<math>\pm</math>2</td> </tr> <tr> <td>5</td> <td>25<math>\pm</math>2</td> </tr> </tbody> </table> <p>•Pretreatment                      Perform a heat treatment at 150<math>\pm</math>5°C for 60<math>\pm</math>5 min. and then let sit for 24<math>\pm</math>2 hrs. at room condition.*</p>	Step	Temperature (°C)	1	25 $\pm$ 2	2	Min. Operating Temp. $\pm$ 3	3	25 $\pm$ 2	4
Step	Temperature (°C)											
1	25 $\pm$ 2											
2	Min. Operating Temp. $\pm$ 3											
3	25 $\pm$ 2											
4	Max. Operating Temp. $\pm$ 2											
5	25 $\pm$ 2											
9	Adhesive Strength of Termination	No removal of the terminations or other defect should occur.	Solder the capacitor to the testing jig (glass epoxy board) shown in Fig. 1. Then apply 10N force in the direction of the arrow. The soldering should be done using the reflow method and should be conducted with care so that the soldering is uniform and free of defects such as heat shock.									
10	Vibration Resistance	Appearance	No defects or abnormalities									
		Capacitance	Within the specified tolerance									
		D.F.	0.025 max.									
			Solder the capacitor to the test jig (glass epoxy board). The capacitor should be subjected to a simple harmonic motion having a total amplitude of 1.5mm, the frequency being varied uniformly between the approximate limits of 10 and 55Hz. The frequency range, from 10 to 55Hz and return to 10Hz, should be traversed in approximately 1 min. This motion should be applied for a period of 2 hrs. in each of 3 mutually perpendicular directions (total of 6 hrs.).									
			 <p>Fig. 1</p>									
												

\* "Room condition" Temperature: 15 to 35°C, Relative humidity: 45 to 75%, Atmospheric pressure: 86 to 106kPa

Continued on the following page. 

For General Purpose GRM/GRU/GR3 Series  
 Only for Applications GR7 Series  
 AC250V Type GA2 Series  
 Safety Standard Certified GA3 Series  
 Product Information

## GR7 Series Specifications and Test Methods

Continued from the preceding page.

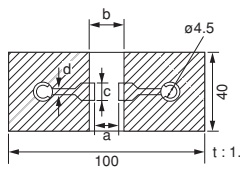
No.	Item	Specifications	Test Method																
11	Deflection	No marking defects	Solder the capacitor to the testing jig (glass epoxy board) shown in Fig. 2. Then apply a force in the direction shown in Fig. 3. The soldering should be done using the reflow method and should be conducted with care so that the soldering is uniform and free of defects such as heat shock.																
		 <p style="text-align: center;">Fig. 2</p> <table border="1" style="margin-left: auto; margin-right: auto;"> <thead> <tr> <th style="text-align: center;">L×W (mm)</th> <th colspan="4" style="text-align: center;">Dimension (mm)</th> </tr> <tr> <th></th> <th style="text-align: center;">a</th> <th style="text-align: center;">b</th> <th style="text-align: center;">c</th> <th style="text-align: center;">d</th> </tr> </thead> <tbody> <tr> <td style="text-align: center;">2.0×1.25</td> <td style="text-align: center;">1.2</td> <td style="text-align: center;">4.0</td> <td style="text-align: center;">1.65</td> <td rowspan="2" style="text-align: center;">1.0</td> </tr> <tr> <td style="text-align: center;">3.2×1.6</td> <td style="text-align: center;">2.2</td> <td style="text-align: center;">5.0</td> <td style="text-align: center;">2.0</td> </tr> </tbody> </table>		L×W (mm)	Dimension (mm)					a	b	c	d	2.0×1.25	1.2	4.0	1.65	1.0	3.2×1.6
L×W (mm)	Dimension (mm)																		
	a	b	c	d															
2.0×1.25	1.2	4.0	1.65	1.0															
3.2×1.6	2.2	5.0	2.0																
12	Solderability of Termination	75% of the terminations are to be soldered evenly and continuously.	Immerse the capacitor in a solution of ethanol (JIS-K-8101) and rosin (JIS-K-5902) (25% rosin in weight proportion). Immerse in solder solution for 2±0.5 sec. Immersing speed: 25±2.5mm/s Temp. of solder: 245±5°C Lead Free Solder (Sn-3.0Ag-0.5Cu) 235±5°C H60A or H63A Eutectic Solder																
13	Resistance to Soldering Heat	Appearance	No marking defects																
		Capacitance Change	Within ±10%																
		D.F.	0.025 max.																
		I.R.	C≥0.01μF: More than 100MΩ • μF C<0.01μF: More than 10,000MΩ																
		Dielectric Strength	In accordance with item No.4																
14	Temperature Cycle	Appearance	No marking defects																
		Capacitance Change	Within ±7.5%																
		D.F.	0.025 max.																
		I.R.	C≥0.01μF: More than 100MΩ • μF C<0.01μF: More than 10,000MΩ																
		Dielectric Strength	In accordance with item No.4																
15	Humidity (Steady State)	Appearance	No marking defects																
		Capacitance Change	Within ±15%																
		D.F.	0.05 max.																
		I.R.	C≥0.01μF: More than 10MΩ • μF C<0.01μF: More than 1,000MΩ																
		Dielectric Strength	In accordance with item No.4																

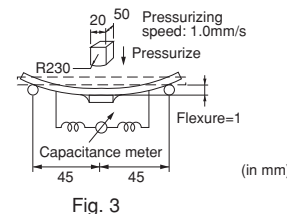

Step	Temperature (°C)	Time (min.)
1	Min. Operating Temp.±3	30±3
2	Room Temp.	2 to 3
3	Max. Operating Temp.±2	30±3
4	Room Temp.	2 to 3

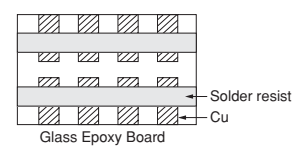

\* "Room condition" Temperature: 15 to 35°C, Relative humidity: 45 to 75%, Atmospheric pressure: 86 to 106kPa

Continued on the following page.

For General Purpose GRM/GRJ/GR3 Series  
 Only for Applications GR7 Series  
 AC250V Type GA2 Series  
 Safety Standard Certified GA3 Series  
 Product Information

## GR7 Series Specifications and Test Methods

↳ Continued from the preceding page.

No.	Item	Specifications	Test Method
16	Life	Appearance	No marking defects
		Capacitance Change	Within ±15%
		D.F.	0.05 max.
		I.R.	C≥0.01μF: More than 10MΩ • μF C<0.01μF: More than 1,000MΩ
		Dielectric Strength	In accordance with item No.4
17	Humidity Loading	Appearance	No marking defects
		Capacitance Change	Within ±15%
		D.F.	0.05 max.
		I.R.	C≥0.01μF: More than 10MΩ • μF C<0.01μF: More than 1,000MΩ
		Dielectric Strength	In accordance with item No.4
			Apply DC350V for 1,000 <sup>+48</sup> hrs. at maximum operating temperature ±3°C. Remove and let sit for 24±2 hrs. at room condition,* then measure. The charge/discharge current is less than 50mA. <b>•Pretreatment</b> Apply test voltage for 60±5 min. at test temperature. Remove and let sit for 24±2 hrs. at room condition.*
			Apply the rated voltage at 40±2°C and relative humidity of 90 to 95% for 500 <sup>+24</sup> hrs. Remove and let sit for 24±2 hrs. at room condition,* then measure. <b>•Pretreatment</b> Apply test voltage for 60±5 min. at test temperature. Remove and let sit for 24±2 hrs. at room condition.*

\* "Room condition" Temperature: 15 to 35°C, Relative humidity: 45 to 75%, Atmospheric pressure: 86 to 106kPa

For General Purpose GRM/GRJ/GR3 Series

Only for Applications GR7 Series

AC250V Type GA2 Series

Safety Standard Certified GA3 Series

Product Information

## Chip Monolithic Ceramic Capacitors

# AC250V Type (Which Meet Japanese Law) GA2 Series

### ■ Features

1. Chip monolithic ceramic capacitor for AC lines.
2. A new monolithic structure for small, high capacitance capable of operating at high voltage levels.
3. Sn-plated external electrodes realize good solderability.
4. Only for reflow soldering
5. Capacitance 0.01 to 0.1uF for connecting lines and 470 to 4700pF for connecting lines to earth.

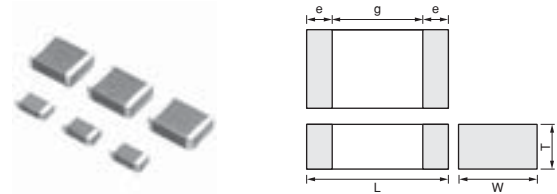

Part Number	Dimensions (mm)				
	L	W	T	e min.	g min.
GA242Q	4.5 ±0.3	2.0 ±0.2	1.5 +0, -0.3	0.3	2.5
GA243D	4.5 ±0.4	3.2 ±0.3	2.0 +0, -0.3		
GA243Q			1.5 +0, -0.3		
GA255D	5.7 ±0.4	5.0 ±0.4	2.0 +0, -0.3		3.2

### ■ Applications

Noise suppression filters for switching power supplies, telephones, facsimiles, modems.

Do not use these products in any Automotive Power train or Safety equipment including Battery chargers for Electric Vehicles and Plug-in Hybrids. Only Murata products clearly stipulated as "for Automotive use" can be used for automobile applications such as Power train and Safety equipment.

### ■ Reference Standard

GA2 series obtains no safety approval. This series is based on the standards of the electrical appliance and material safety law of Japan (separated table 4).

Part Number	Rated Voltage	TC Code (Standard)	Capacitance	Length L (mm)	Width W (mm)	Thickness T max. (mm)	Electrode g min.	Electrode e
GA242QR7E2471MW01L	250Vac(r.m.s.)	X7R (EIA)	470pF±20%	4.5	2.0	1.5	2.5mm	0.3mm min.
GA242QR7E2102MW01L	250Vac(r.m.s.)	X7R (EIA)	1000pF±20%	4.5	2.0	1.5	2.5mm	0.3mm min.
GA243QR7E2222MW01L	250Vac(r.m.s.)	X7R (EIA)	2200pF±20%	4.5	3.2	1.5	2.5mm	0.3mm min.
GA243QR7E2332MW01L	250Vac(r.m.s.)	X7R (EIA)	3300pF±20%	4.5	3.2	1.5	2.5mm	0.3mm min.
GA243DR7E2472MW01L	250Vac(r.m.s.)	X7R (EIA)	4700pF±20%	4.5	3.2	2	2.5mm	0.3mm min.
GA243QR7E2103MW01L	250Vac(r.m.s.)	X7R (EIA)	1000pF±20%	4.5	3.2	1.5	2.5mm	0.3mm min.
GA243QR7E2223MW01L	250Vac(r.m.s.)	X7R (EIA)	2200pF±20%	4.5	3.2	1.5	2.5mm	0.3mm min.
GA243DR7E2473MW01L	250Vac(r.m.s.)	X7R (EIA)	4700pF±20%	4.5	3.2	2	2.5mm	0.3mm min.
GA255DR7E2104MW01L	250Vac(r.m.s.)	X7R (EIA)	0.10μF±20%	5.7	5.0	2	3.2mm	0.3mm min.

For General Purpose GRM/GRJ/GR3 Series

Only for Applications

AC250V Type GA2 Series

Safety Standard Certified GA3 Series

Product Information

## GA2 Series Specifications and Test Methods

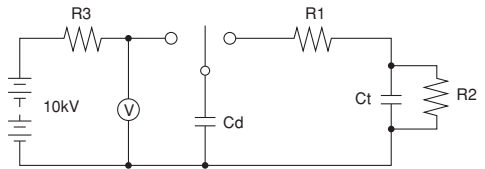
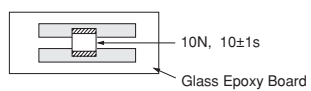
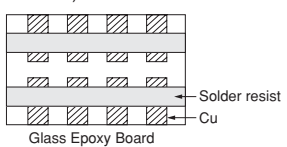
No.	Item	Specifications	Test Method												
1	Operating Temperature Range	-55 to +125°C	-												
2	Appearance	No defects or abnormalities	Visual inspection												
3	Dimensions	Within the specified dimensions	Using calipers and micrometers												
4	Dielectric Strength	No defects or abnormalities	No failure should be observed when voltage in the table is applied between the terminations for 60±1 sec., provided the charge/discharge current is less than 50mA. <table border="1"> <thead> <tr> <th>Nominal Capacitance</th> <th>Test Voltage</th> </tr> </thead> <tbody> <tr> <td>C≥10,000pF</td> <td>AC575V (r.m.s.)</td> </tr> <tr> <td>C&lt;10,000pF</td> <td>AC1500V (r.m.s.)</td> </tr> </tbody> </table>	Nominal Capacitance	Test Voltage	C≥10,000pF	AC575V (r.m.s.)	C<10,000pF	AC1500V (r.m.s.)						
Nominal Capacitance	Test Voltage														
C≥10,000pF	AC575V (r.m.s.)														
C<10,000pF	AC1500V (r.m.s.)														
5	Insulation Resistance (I.R.)	More than 2,000MΩ	The insulation resistance should be measured with DC500±50V and within 60±5 sec. of charging.												
6	Capacitance	Within the specified tolerance	The capacitance/D.F. should be measured at a frequency of 1±0.2kHz and a voltage of AC1±0.2V (r.m.s.).												
7	Dissipation Factor (D.F.)	0.025 max.													
8	Capacitance Temperature Characteristics	Cap. Change Within ±15% (Temp. Range: -55 to +125°C)	The capacitance measurement should be made at each step specified in the Table. <table border="1"> <thead> <tr> <th>Step</th> <th>Temperature (°C)</th> </tr> </thead> <tbody> <tr> <td>1</td> <td>25±2</td> </tr> <tr> <td>2</td> <td>Min. Operating Temp.±3</td> </tr> <tr> <td>3</td> <td>25±2</td> </tr> <tr> <td>4</td> <td>Max. Operating Temp.±2</td> </tr> <tr> <td>5</td> <td>25±2</td> </tr> </tbody> </table> <p>•Pretreatment                      Perform a heat treatment at 150±18°C for 60±5 min. and then let sit for 24±2 hrs. at room condition.*</p>	Step	Temperature (°C)	1	25±2	2	Min. Operating Temp.±3	3	25±2	4	Max. Operating Temp.±2	5	25±2
Step	Temperature (°C)														
1	25±2														
2	Min. Operating Temp.±3														
3	25±2														
4	Max. Operating Temp.±2														
5	25±2														
9	Discharge Test (Application: Nominal Capacitance C<10,000pF)	Appearance No defects or abnormalities	As in Fig., discharge is made 50 times at 5 sec. intervals from the capacitor (Cd) charged at DC voltage of specified.  Ct: Capacitor under test Cd: 0.001μF R1: 1,000Ω R2: 100MΩ R3: Surge resistance												
10	Adhesive Strength of Termination	No removal of the terminations or other defects should occur.	Solder the capacitor to the testing jig (glass epoxy board) shown in Fig. 1. Then apply 10N force in the direction of the arrow. The soldering should be done using the reflow method and should be conducted with care so that the soldering is uniform and free of defects such as heat shock.  Fig. 1												
11	Vibration Resistance	Appearance	No defects or abnormalities												
		Capacitance	Within the specified tolerance												
		D.F.	0.025 max.												
			Solder the capacitor to the test jig (glass epoxy board). The capacitor should be subjected to a simple harmonic motion having a total amplitude of 1.5mm, the frequency being varied uniformly between the approximate limits of 10 and 55Hz. The frequency range, from 10 to 55Hz and return to 10Hz, should be traversed in approximately 1 min. This motion should be applied for a period of 2 hrs. in each of 3 mutually perpendicular directions (total of 6 hrs.). 												

\* "Room condition" Temperature: 15 to 35°C, Relative humidity: 45 to 75%, Atmospheric pressure: 86 to 106kPa

Continued on the following page. 

For General Purpose GRM/GRU/GR3 Series  
 Only for Applications AC250V Type GA2 Series  
 Safety Standard Certified GA3 Series  
 Product Information



## GA2 Series Specifications and Test Methods

Continued from the preceding page.

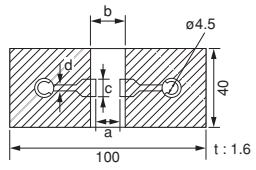
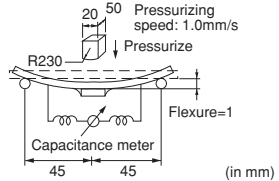
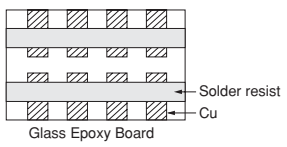
No.	Item	Specifications	Test Method																			
12	Deflection	No marking defects	Solder the capacitor to the testing jig (glass epoxy board) shown in Fig. 2. Then apply a force in the direction shown in Fig. 3. The soldering should be done using the reflow method and should be conducted with care so that the soldering is uniform and free of defects such as heat shock.																			
		<div style="text-align: center;">  <p>Fig. 2</p> <table border="1" style="margin-left: auto; margin-right: auto;"> <thead> <tr> <th rowspan="2">L×W (mm)</th> <th colspan="4">Dimension (mm)</th> </tr> <tr> <th>a</th> <th>b</th> <th>c</th> <th>d</th> </tr> </thead> <tbody> <tr> <td>4.5×2.0</td> <td>3.5</td> <td>7.0</td> <td>2.4</td> <td rowspan="3" style="text-align: center;">1.0</td> </tr> <tr> <td>4.5×3.2</td> <td>3.5</td> <td>7.0</td> <td>3.7</td> </tr> <tr> <td>5.7×5.0</td> <td>4.5</td> <td>8.0</td> <td>5.6</td> </tr> </tbody> </table> </div>		L×W (mm)	Dimension (mm)				a	b	c	d	4.5×2.0	3.5	7.0	2.4	1.0	4.5×3.2	3.5	7.0	3.7	5.7×5.0
L×W (mm)	Dimension (mm)																					
	a	b	c	d																		
4.5×2.0	3.5	7.0	2.4	1.0																		
4.5×3.2	3.5	7.0	3.7																			
5.7×5.0	4.5	8.0	5.6																			
			 <p>Fig. 3</p>																			
13	Solderability of Termination	75% of the terminations are to be soldered evenly and continuously.	Immerse the capacitor in a solution of ethanol (JIS-K-8101) and rosin (JIS-K-5902) (25% rosin in weight proportion). Immerse in solder solution for 2±0.5 sec. Immersing speed: 25±2.5mm/s Temp. of solder: 245±5°C Lead Free Solder (Sn-3.0Ag-0.5Cu) 235±5°C H60A or H63A Eutectic Solder																			
14	Humidity Insulation	Appearance	No marking defects																			
		Capacitance Change	Within ±15%																			
		D.F.	0.05 max.																			
		I.R.	More than 1,000MΩ																			
		Dielectric Strength	In accordance with item No.4																			
			The capacitor should be subjected to 40±2°C, relative humidity of 90 to 98% for 8 hrs., and then removed in room condition* for 16 hrs. until 5 cycles.																			
15	Resistance to Soldering Heat	Appearance	No marking defects																			
		Capacitance Change	Within ±10%																			
		D.F.	0.025 max.																			
		I.R.	More than 2,000MΩ																			
		Dielectric Strength	In accordance with item No.4																			
			Preheat the capacitor as in table. Immerse the capacitor in solder solution at 260±5°C for 10±1 sec. Let sit at room condition* for 24±2 hrs., then measure. •Immersing speed: 25±2.5mm/s •Pretreatment Perform a heat treatment at 150±18°C for 60±5 min. and then let sit for 24±2 hrs. at room condition.* *Preheating																			
			<table border="1" style="margin-left: auto; margin-right: auto;"> <thead> <tr> <th>Step</th> <th>Temperature</th> <th>Time</th> </tr> </thead> <tbody> <tr> <td style="text-align: center;">1</td> <td style="text-align: center;">100 to 120°C</td> <td style="text-align: center;">1 min.</td> </tr> <tr> <td style="text-align: center;">2</td> <td style="text-align: center;">170 to 200°C</td> <td style="text-align: center;">1 min.</td> </tr> </tbody> </table>	Step	Temperature	Time	1	100 to 120°C	1 min.	2	170 to 200°C	1 min.										
Step	Temperature	Time																				
1	100 to 120°C	1 min.																				
2	170 to 200°C	1 min.																				
16	Temperature Cycle	Appearance	No marking defects																			
		Capacitance Change	Within ±15%																			
		D.F.	0.05 max.																			
		I.R.	More than 2,000MΩ																			
		Dielectric Strength	In accordance with item No.4																			
			Fix the capacitor to the supporting jig (glass epoxy board) shown in Fig. 4. Perform the 5 cycles according to the 4 heat treatments listed in the following table. Let sit for 24±2 hrs. at room condition,* then measure.																			
			<table border="1" style="margin-left: auto; margin-right: auto;"> <thead> <tr> <th>Step</th> <th>Temperature (°C)</th> <th>Time (min.)</th> </tr> </thead> <tbody> <tr> <td style="text-align: center;">1</td> <td style="text-align: center;">Min. Operating Temp.±3</td> <td style="text-align: center;">30±3</td> </tr> <tr> <td style="text-align: center;">2</td> <td style="text-align: center;">Room Temp.</td> <td style="text-align: center;">2 to 3</td> </tr> <tr> <td style="text-align: center;">3</td> <td style="text-align: center;">Max. Operating Temp.±2</td> <td style="text-align: center;">30±3</td> </tr> <tr> <td style="text-align: center;">4</td> <td style="text-align: center;">Room Temp.</td> <td style="text-align: center;">2 to 3</td> </tr> </tbody> </table>	Step	Temperature (°C)	Time (min.)	1	Min. Operating Temp.±3	30±3	2	Room Temp.	2 to 3	3	Max. Operating Temp.±2	30±3	4	Room Temp.	2 to 3				
Step	Temperature (°C)	Time (min.)																				
1	Min. Operating Temp.±3	30±3																				
2	Room Temp.	2 to 3																				
3	Max. Operating Temp.±2	30±3																				
4	Room Temp.	2 to 3																				
			•Pretreatment Perform a heat treatment at 150±18°C for 60±5 min. and then let sit for 24±2 hrs. at room condition.*																			
			 <p>Fig. 4</p>																			

\* "Room condition" Temperature: 15 to 35°C, Relative humidity: 45 to 75%, Atmospheric pressure: 86 to 106kPa

Continued on the following page.

For General Purpose GRM/GRJ/GR3 Series

Only for Applications

AC250V Type GA2 Series

Safety Standard Certified GA3 Series

Product Information

## GA2 Series Specifications and Test Methods

Continued from the preceding page.

No.	Item	Specifications	Test Method									
17	Humidity (Steady State)	Appearance	No marking defects									
		Capacitance Change	Within ±15%									
		D.F.	0.05 max.									
		I.R.	More than 1,000MΩ									
		Dielectric Strength	In accordance with item No.4									
			Let the capacitor sit at 40±2°C and relative humidity of 90 to 95% for 500 <sup>±24</sup> hrs. Remove and let sit for 24±2 hrs. at room condition,* then measure. <b>•Pretreatment</b> Perform a heat treatment at 150 <sup>±10</sup> °C for 60±5 min. and then let sit for 24±2 hrs. at room condition.*									
18	Life	Appearance	No marking defects									
		Capacitance Change	Within ±20%									
		D.F.	0.05 max.									
		I.R.	More than 1,000MΩ									
		Dielectric Strength	In accordance with item No.4									
			Apply voltage and time as in Table at maximum operating temperature ±3°C. Remove and let sit for 24±2 hrs. at room condition,* then measure. The charge / discharge current is less than 50mA.									
			<table border="1"> <thead> <tr> <th>Nominal Capacitance</th> <th>Test Time</th> <th>Test Voltage</th> </tr> </thead> <tbody> <tr> <td>C≥10,000pF</td> <td>1,000<sup>±48</sup> hrs.</td> <td>AC300V (r.m.s.)</td> </tr> <tr> <td>C&lt;10,000pF</td> <td>1,500<sup>±48</sup> hrs.</td> <td>AC500V (r.m.s.)*</td> </tr> </tbody> </table>	Nominal Capacitance	Test Time	Test Voltage	C≥10,000pF	1,000 <sup>±48</sup> hrs.	AC300V (r.m.s.)	C<10,000pF	1,500 <sup>±48</sup> hrs.	AC500V (r.m.s.)*
Nominal Capacitance	Test Time	Test Voltage										
C≥10,000pF	1,000 <sup>±48</sup> hrs.	AC300V (r.m.s.)										
C<10,000pF	1,500 <sup>±48</sup> hrs.	AC500V (r.m.s.)*										
			* Except that once each hour the voltage is increased to AC1,000V (r.m.s.) for 0.1 sec. <b>•Pretreatment</b> Apply test voltage for 60±5 min. at test temperature. Remove and let sit for 24±2 hrs. at room condition.*									
19	Humidity Loading	Appearance	No marking defects									
		Capacitance Change	Within ±15%									
		D.F.	0.05 max.									
		I.R.	More than 1,000MΩ									
		Dielectric Strength	In accordance with item No.4									
			Apply the rated voltage at 40±2°C and relative humidity of 90 to 95% for 500 <sup>±24</sup> hrs. Remove and let sit for 24±2 hrs. at room condition,* then measure. <b>•Pretreatment</b> Apply test voltage for 60±5 min. at test temperature. Remove and let sit for 24±2 hrs. at room condition.*									

\* "Room condition" Temperature: 15 to 35°C, Relative humidity: 45 to 75%, Atmospheric pressure: 86 to 106kPa

For General Purpose GRM/GRJ/GR3 Series

Only for Applications

AC250V Type GA2 Series

Safety Standard Certified GA3 Series

Product Information

## Chip Monolithic Ceramic Capacitors

# Safety Standard Certified GA3 Series UL, IEC60384-14 Class X1/Y2 Type GC

### ■ Features

1. Chip monolithic ceramic capacitor (certified as conforming to safety standards) for AC lines.
2. A new monolithic structure for small, high capacitance capable of operating at high voltage levels.
3. Compared to lead type capacitors, this new capacitor is greatly downsized and low-profiled to 1/10 or less in volume, and 1/4 or less in height.
4. Type GC can be used as an X1-class and Y2-class capacitor, line-by-pass capacitor of UL1414.
5. +125 degree C guaranteed
6. Only for reflow soldering

### ■ Applications

1. Ideal for use as Y capacitor or X capacitor for various switching power supplies
2. Ideal for modem applications

Do not use these products in any Automotive Power train or Safety equipment including Battery chargers for Electric Vehicles and Plug-in Hybrids. Only Murata products clearly stipulated as "for Automotive use" can be used for automobile applications such as Power train and Safety equipment.

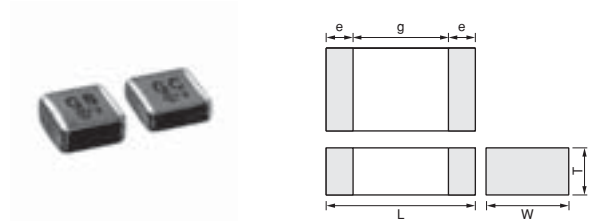

Part Number	Dimensions (mm)				
	L	W	T	e min.	g min.
<b>GA355D</b>	5.7 ±0.4	5.0 ±0.4	2.0 ±0.3	0.3	4.0

### ■ Standard Certification

	Standard No.	Class	Rated Voltage
UL	UL1414	Line By-pass	AC250V (r.m.s.)
VDE	IEC 60384-14 EN 60384-14	X1, Y2	
BSI	EN 60065 (14.2) IEC 60384-14 EN 60384-14		
SEMKO	IEC 60384-14 EN 60384-14		
ESTI	IEC 60384-14		

Part Number	Rated Voltage	TC Code (Standard)	Capacitance	Length L (mm)	Width W (mm)	Thickness T max. (mm)	Electrode g min.	Electrode e
<b>GA355DR7GC101KY02L</b>	250Vac(r.m.s.)	X7R (EIA)	100pF±10%	5.7	5.0	2.3	4.0mm	0.3mm min.
<b>GA355DR7GC151KY02L</b>	250Vac(r.m.s.)	X7R (EIA)	150pF±10%	5.7	5.0	2.3	4.0mm	0.3mm min.
<b>GA355DR7GC221KY02L</b>	250Vac(r.m.s.)	X7R (EIA)	220pF±10%	5.7	5.0	2.3	4.0mm	0.3mm min.
<b>GA355DR7GC331KY02L</b>	250Vac(r.m.s.)	X7R (EIA)	330pF±10%	5.7	5.0	2.3	4.0mm	0.3mm min.

For General Purpose GRW/GRJ/GR3 Series

Only for Applications

AC250V Type GA2 Series

Safety Standard Certified GA3 Series

Product Information

## Chip Monolithic Ceramic Capacitors

# Safety Standard Certified GA3 Series IEC60384-14 Class Y2, X1/Y2 Type GF

### ■ Features

1. Available for equipment based on IEC/EN60950 and UL1950. Besides, the GA352/355 types are available for equipment based on IEC/EN60065, UL1492, and UL6500.
2. Type GF can be used as a Y2-class capacitor.
3. A new monolithic structure for small, high capacitance capable of operating at high voltage levels.
4. +125 degree C guaranteed
5. Only for reflow soldering

### ■ Applications

1. Ideal for use on line filters and couplings for DAA modems without transformers
2. Ideal for use on line filters for information equipment
3. Ideal for use as Y capacitor or X capacitor for various switching power supplies (GA352/355 types only)

Do not use these products in any Automotive Power train or Safety equipment including Battery chargers for Electric Vehicles and Plug-in Hybrids. Only Murata products clearly stipulated as "for Automotive use" can be used for automobile applications such as Power train and Safety equipment.

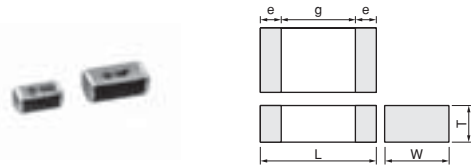

Part Number	Dimensions (mm)				
	L	W	T	e min.	g min.
GA342A	4.5 ±0.3	2.0 ±0.2	1.0 +0, -0.3	0.3	2.5
GA342D			2.0 ±0.2		
GA342Q			1.5 +0, -0.3		
GA352Q	5.7 ±0.4	2.8 ±0.3	1.5 +0, -0.3		4.0
GA355D			2.0 +0, -0.3		
GA355Q			1.5 +0, -0.3		

### ■ Standard Certification

	Standard No.	Class	Status of Certification		Rated Voltage
			Size : 4.5x2.0mm	Size : 5.7x2.8mm and over	
UL	UL1414	X1, Y2	—	⊙	AC250V (r.m.s.)
	UL 60950-1	—	⊙	—	
VDE	IEC 60384-14	X1, Y2	—	⊙	(r.m.s.)
SEMKO	EN 60384-14	Y2	⊙	⊙	

### Applications

Size	Switching power supplies	Communication network devices such as a modem
4.5x2.0mm	—	⊙
5.7x2.8mm and over	⊙	⊙

Part Number	Rated Voltage	TC Code (Standard)	Capacitance	Length L (mm)	Width W (mm)	Thickness T max. (mm)	Electrode g min.	Electrode e
GA342D1XGF100JY02L	250Vac(r.m.s.)	SL (JIS)	10pF±5%	4.5	2.0	2.2	2.5mm	0.3mm min.
GA342D1XGF120JY02L	250Vac(r.m.s.)	SL (JIS)	12pF±5%	4.5	2.0	2.2	2.5mm	0.3mm min.
GA342D1XGF150JY02L	250Vac(r.m.s.)	SL (JIS)	15pF±5%	4.5	2.0	2.2	2.5mm	0.3mm min.
GA342D1XGF180JY02L	250Vac(r.m.s.)	SL (JIS)	18pF±5%	4.5	2.0	2.2	2.5mm	0.3mm min.
GA342D1XGF220JY02L	250Vac(r.m.s.)	SL (JIS)	22pF±5%	4.5	2.0	2.2	2.5mm	0.3mm min.
GA342A1XGF270JW31L	250Vac(r.m.s.)	SL (JIS)	27pF±5%	4.5	2.0	1	2.5mm	0.3mm min.
GA342A1XGF330JW31L	250Vac(r.m.s.)	SL (JIS)	33pF±5%	4.5	2.0	1	2.5mm	0.3mm min.
GA342A1XGF390JW31L	250Vac(r.m.s.)	SL (JIS)	39pF±5%	4.5	2.0	1	2.5mm	0.3mm min.
GA342A1XGF470JW31L	250Vac(r.m.s.)	SL (JIS)	47pF±5%	4.5	2.0	1	2.5mm	0.3mm min.
GA342A1XGF560JW31L	250Vac(r.m.s.)	SL (JIS)	56pF±5%	4.5	2.0	1	2.5mm	0.3mm min.
GA342A1XGF680JW31L	250Vac(r.m.s.)	SL (JIS)	68pF±5%	4.5	2.0	1	2.5mm	0.3mm min.
GA342A1XGF820JW31L	250Vac(r.m.s.)	SL (JIS)	82pF±5%	4.5	2.0	1	2.5mm	0.3mm min.
GA342QR7GF101KW01L	250Vac(r.m.s.)	X7R (EIA)	100pF±10%	4.5	2.0	1.5	2.5mm	0.3mm min.
GA342QR7GF151KW01L	250Vac(r.m.s.)	X7R (EIA)	150pF±10%	4.5	2.0	1.5	2.5mm	0.3mm min.
GA342DR7GF221KW02L	250Vac(r.m.s.)	X7R (EIA)	220pF±10%	4.5	2.0	2.2	2.5mm	0.3mm min.
GA342DR7GF331KW02L	250Vac(r.m.s.)	X7R (EIA)	330pF±10%	4.5	2.0	2.2	2.5mm	0.3mm min.
GA342QR7GF471KW01L	250Vac(r.m.s.)	X7R (EIA)	470pF±10%	4.5	2.0	1.5	2.5mm	0.3mm min.
GA352QR7GF471KW01L	250Vac(r.m.s.)	X7R (EIA)	470pF±10%	5.7	2.8	1.5	4.0mm	0.3mm min.
GA342QR7GF681KW01L	250Vac(r.m.s.)	X7R (EIA)	680pF±10%	4.5	2.0	1.5	2.5mm	0.3mm min.
GA352QR7GF681KW01L	250Vac(r.m.s.)	X7R (EIA)	680pF±10%	5.7	2.8	1.5	4.0mm	0.3mm min.
GA342DR7GF102KW02L	250Vac(r.m.s.)	X7R (EIA)	1000pF±10%	4.5	2.0	2.2	2.5mm	0.3mm min.
GA352QR7GF102KW01L	250Vac(r.m.s.)	X7R (EIA)	1000pF±10%	5.7	2.8	1.5	4.0mm	0.3mm min.

Continued on the following page. ↗

For General Purpose GRM/GRU/GR3 Series  
 Only for Applications  
 AC250V Type GA2 Series  
 Safety Standard Certified GA3 Series  
 Product Information

Continued from the preceding page.

Part Number	Rated Voltage	TC Code (Standard)	Capacitance	Length L (mm)	Width W (mm)	Thickness T max. (mm)	Electrode g min.	Electrode e
<b>GA352QR7GF152KW01L</b>	250Vac(r.m.s.)	X7R (EIA)	1500pF±10%	5.7	2.8	1.5	4.0mm	0.3mm min.
<b>GA355QR7GF182KW01L</b>	250Vac(r.m.s.)	X7R (EIA)	1800pF±10%	5.7	5.0	1.5	4.0mm	0.3mm min.
<b>GA355QR7GF222KW01L</b>	250Vac(r.m.s.)	X7R (EIA)	2200pF±10%	5.7	5.0	1.5	4.0mm	0.3mm min.
<b>GA355QR7GF332KW01L</b>	250Vac(r.m.s.)	X7R (EIA)	3300pF±10%	5.7	5.0	1.5	4.0mm	0.3mm min.
<b>GA355DR7GF472KW01L</b>	250Vac(r.m.s.)	X7R (EIA)	4700pF±10%	5.7	5.0	2	4.0mm	0.3mm min.

For General Purpose  
 GRW/GRJ/GR3 Series

Only for Applications

AC250V Type  
 GA2 Series

Safety Standard  
 Certified GA3 Series

Product Information

## Chip Monolithic Ceramic Capacitors

# Safety Standard Certified GA3 Series IEC60384-14 Class Y3 Type GD

### ■ Features

1. Available for equipment based on IEC/EN60950 and UL1950.
2. Type GD can be used as a Y3-class capacitor.
3. A new monolithic structure for small, high capacitance capable of operating at high voltage levels.
4. +125 degree C guaranteed
5. Only for reflow soldering

### ■ Applications

1. Ideal for use on line filters and couplings for DAA modems without transformers
2. Ideal for use on line filters for information equipment

Do not use these products in any Automotive Power train or Safety equipment including Battery chargers for Electric Vehicles and Plug-in Hybrids. Only Murata products clearly stipulated as "for Automotive use" can be used for automobile applications such as Power train and Safety equipment.

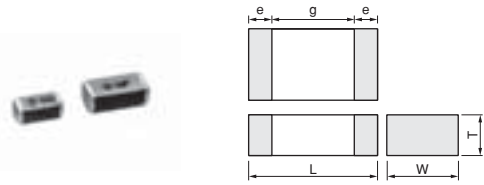

Part Number	Dimensions (mm)				
	L	W	T	e min.	g min.
GA342A	4.5 ±0.3	2.0 ±0.2	1.0 +0, -0.3	0.3	2.5
GA342D			2.0 ±0.2		
GA342Q			1.5 +0, -0.3		
GA343D	4.5 ±0.4	3.2 ±0.3	2.0 +0, -0.3		
GA343Q			1.5 +0, -0.3		

### ■ Standard Certification

	Standard No.	Class	Rated Voltage
UL	UL 60950-1	—	AC250V(r.m.s.)
SEMKO	IEC 60384-14 EN 60384-14	Y3	

### Applications

Size	Switching power supplies	Communication network devices such as a modem
4.5x3.2mm and under	—	◎

Part Number	Rated Voltage	TC Code (Standard)	Capacitance	Length L (mm)	Width W (mm)	Thickness T max. (mm)	Electrode g min.	Electrode e
GA342D1XGD100JY02L	250Vac(r.m.s.)	SL (JIS)	10pF±5%	4.5	2.0	2.2	2.5mm	0.3mm min.
GA342D1XGD120JY02L	250Vac(r.m.s.)	SL (JIS)	12pF±5%	4.5	2.0	2.2	2.5mm	0.3mm min.
GA342D1XGD150JY02L	250Vac(r.m.s.)	SL (JIS)	15pF±5%	4.5	2.0	2.2	2.5mm	0.3mm min.
GA342D1XGD180JY02L	250Vac(r.m.s.)	SL (JIS)	18pF±5%	4.5	2.0	2.2	2.5mm	0.3mm min.
GA342D1XGD220JY02L	250Vac(r.m.s.)	SL (JIS)	22pF±5%	4.5	2.0	2.2	2.5mm	0.3mm min.
GA342A1XGD270JW31L	250Vac(r.m.s.)	SL (JIS)	27pF±5%	4.5	2.0	1	2.5mm	0.3mm min.
GA342A1XGD330JW31L	250Vac(r.m.s.)	SL (JIS)	33pF±5%	4.5	2.0	1	2.5mm	0.3mm min.
GA342A1XGD390JW31L	250Vac(r.m.s.)	SL (JIS)	39pF±5%	4.5	2.0	1	2.5mm	0.3mm min.
GA342A1XGD470JW31L	250Vac(r.m.s.)	SL (JIS)	47pF±5%	4.5	2.0	1	2.5mm	0.3mm min.
GA342A1XGD560JW31L	250Vac(r.m.s.)	SL (JIS)	56pF±5%	4.5	2.0	1	2.5mm	0.3mm min.
GA342A1XGD680JW31L	250Vac(r.m.s.)	SL (JIS)	68pF±5%	4.5	2.0	1	2.5mm	0.3mm min.
GA342A1XGD820JW31L	250Vac(r.m.s.)	SL (JIS)	82pF±5%	4.5	2.0	1	2.5mm	0.3mm min.
GA342QR7GD101KW01L	250Vac(r.m.s.)	X7R (EIA)	100pF±10%	4.5	2.0	1.5	2.5mm	0.3mm min.
GA342QR7GD151KW01L	250Vac(r.m.s.)	X7R (EIA)	150pF±10%	4.5	2.0	1.5	2.5mm	0.3mm min.
GA342QR7GD221KW01L	250Vac(r.m.s.)	X7R (EIA)	220pF±10%	4.5	2.0	1.5	2.5mm	0.3mm min.
GA342QR7GD331KW01L	250Vac(r.m.s.)	X7R (EIA)	330pF±10%	4.5	2.0	1.5	2.5mm	0.3mm min.
GA342QR7GD471KW01L	250Vac(r.m.s.)	X7R (EIA)	470pF±10%	4.5	2.0	1.5	2.5mm	0.3mm min.
GA342QR7GD681KW01L	250Vac(r.m.s.)	X7R (EIA)	680pF±10%	4.5	2.0	1.5	2.5mm	0.3mm min.
GA342QR7GD102KW01L	250Vac(r.m.s.)	X7R (EIA)	1000pF±10%	4.5	2.0	1.5	2.5mm	0.3mm min.
GA342QR7GD152KW01L	250Vac(r.m.s.)	X7R (EIA)	1500pF±10%	4.5	2.0	1.5	2.5mm	0.3mm min.
GA343QR7GD182KW01L	250Vac(r.m.s.)	X7R (EIA)	1800pF±10%	4.5	3.2	1.5	2.5mm	0.3mm min.
GA343QR7GD222KW01L	250Vac(r.m.s.)	X7R (EIA)	2200pF±10%	4.5	3.2	1.5	2.5mm	0.3mm min.
GA343DR7GD472KW01L	250Vac(r.m.s.)	X7R (EIA)	4700pF±10%	4.5	3.2	2	2.5mm	0.3mm min.

For General Purpose GRM/GRU/GR3 Series  
 Only for Applications  
 AC250V Type GA2 Series  
 Safety Standard Certified GA3 Series  
 Product Information



## Chip Monolithic Ceramic Capacitors

# Safety Standard Certified GA3 Series IEC60384-14 Class X2 Type GB

### ■ Features

1. Type GB can be used as an X2-class capacitor.
2. Chip monolithic ceramic capacitor (certified as conforming to safety standards) for AC lines.
3. A new monolithic structure for small, high capacitance capable of operating at high voltage levels.
4. Compared to lead type capacitors, this new capacitor is greatly downsized and low-profiled to 1/10 or less in volume, and 1/4 or less in height.
5. +125 degree C guaranteed
6. Only for reflow soldering

### ■ Applications

Ideal for use as X capacitor for various switching power supplies

Do not use these products in any Automotive Power train or Safety equipment including Battery chargers for Electric Vehicles and Plug-in Hybrids. Only Murata products clearly stipulated as "for Automotive use" can be used for automobile applications such as Power train and Safety equipment.

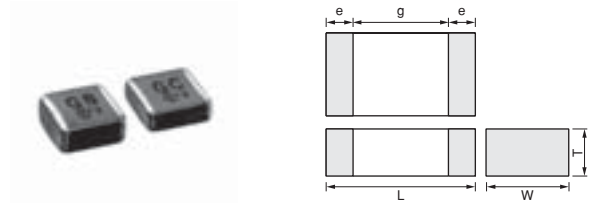

Part Number	Dimensions (mm)				
	L	W	T	e min.	g min.
GA355Q	5.7 ±0.4	5.0 ±0.4	1.5 +0,-0.3	0.3	3.0
GA355D			2.0 +0,-0.3		
GA355E			2.5 +0,-0.3		
GA355X			2.9 +0,-0.4		

### ■ Standard Certification

	Standard No.	Class	Rated Voltage
VDE	IEC 60384-14	X2	AC250V (r.m.s.)
SEMKO	EN 60384-14		
ESTI	IEC 60384-14		

Part Number	Rated Voltage	TC Code (Standard)	Capacitance	Length L (mm)	Width W (mm)	Thickness T max. (mm)	Electrode g min.	Electrode e
GA355QR7GB103KW01L	250Vac(r.m.s.)	X7R (EIA)	10000pF±10%	5.7	5.0	1.5	3.0mm	0.3mm min.
GA355QR7GB153KW01L	250Vac(r.m.s.)	X7R (EIA)	15000pF±10%	5.7	5.0	1.5	3.0mm	0.3mm min.
GA355DR7GB223KW01L	250Vac(r.m.s.)	X7R (EIA)	22000pF±10%	5.7	5.0	2	3.0mm	0.3mm min.
GA355ER7GB333KW01L	250Vac(r.m.s.)	X7R (EIA)	33000pF±10%	5.7	5.0	2.5	3.0mm	0.3mm min.
GA355ER7GB473KW01L	250Vac(r.m.s.)	X7R (EIA)	47000pF±10%	5.7	5.0	2.5	3.0mm	0.3mm min.
GA355XR7GB563KW06L	250Vac(r.m.s.)	X7R (EIA)	56000pF±10%	5.7	5.0	2.9	3.0mm	0.3mm min.

For General Purpose GRW/GRJ/GR3 Series

Only for Applications

AC250V Type GA2 Series

Safety Standard Certified GA3 Series

Product Information

## GA3 Series Specifications and Test Methods

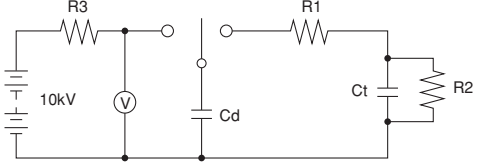
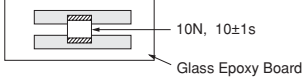
No.	Item	Specifications	Test Method																				
1	Operating Temperature Range	-55 to +125°C	-																				
2	Appearance	No defects or abnormalities	Visual inspection																				
3	Dimensions	Within the specified dimensions	Using calipers and micrometers																				
4	Dielectric Strength	No defects or abnormalities	No failure should be observed when voltage in the table is applied between the terminations for 60±1 sec., provided the charge/discharge current is less than 50mA. <table border="1"> <thead> <tr> <th></th> <th>Test Voltage</th> </tr> </thead> <tbody> <tr> <td>Type GB</td> <td>DC1075V</td> </tr> <tr> <td>Type GC/GD</td> <td>AC1500V (r.m.s.)</td> </tr> <tr> <td>Type GF</td> <td>AC2000V (r.m.s.)</td> </tr> </tbody> </table>		Test Voltage	Type GB	DC1075V	Type GC/GD	AC1500V (r.m.s.)	Type GF	AC2000V (r.m.s.)												
	Test Voltage																						
Type GB	DC1075V																						
Type GC/GD	AC1500V (r.m.s.)																						
Type GF	AC2000V (r.m.s.)																						
5	Pulse Voltage (Application: Type GD/GF)	No self healing breakdowns or flash-overs have taken place in the capacitor.	10 impulses of alternating polarity are subjected. (5 impulses for each polarity) The interval between impulses is 60 sec. Applied Pulse: 1.2/50µs Applied Voltage: 2.5kVo-p																				
6	Insulation Resistance (I.R.)	More than 6,000MΩ	The insulation resistance should be measured with DC500±50V and within 60±5 sec. of charging.																				
7	Capacitance	Within the specified tolerance	The capacitance/Q/D.F. should be measured at a frequency of 1±0.2kHz (SL char.: 1±0.2MHz) and a voltage of AC1±0.2V (r.m.s.).																				
8	Dissipation Factor (D.F.) Q	<table border="1"> <thead> <tr> <th>Char.</th> <th>Specification</th> </tr> </thead> <tbody> <tr> <td>X7R</td> <td>D.F. ≤ 0.025</td> </tr> <tr> <td>SL</td> <td>Q ≥ 400 + 20C*2 (C &lt; 30pF) Q ≥ 1000 (C ≥ 30pF)</td> </tr> </tbody> </table>		Char.	Specification	X7R	D.F. ≤ 0.025	SL	Q ≥ 400 + 20C*2 (C < 30pF) Q ≥ 1000 (C ≥ 30pF)														
Char.	Specification																						
X7R	D.F. ≤ 0.025																						
SL	Q ≥ 400 + 20C*2 (C < 30pF) Q ≥ 1000 (C ≥ 30pF)																						
9	Capacitance Temperature Characteristics	<table border="1"> <thead> <tr> <th>Char.</th> <th>Capacitance Change</th> </tr> </thead> <tbody> <tr> <td>X7R</td> <td>Within ±15%</td> </tr> </tbody> </table> Temperature characteristic guarantee is -55 to +125°C <table border="1"> <thead> <tr> <th>Char.</th> <th>Temperature Coefficient</th> </tr> </thead> <tbody> <tr> <td>SL</td> <td>+350 to -1000ppm/°C</td> </tr> </tbody> </table> Temperature characteristic guarantee is +20 to +85°C	Char.	Capacitance Change	X7R	Within ±15%	Char.	Temperature Coefficient	SL	+350 to -1000ppm/°C	The capacitance measurement should be made at each step specified in the Table. <table border="1"> <thead> <tr> <th>Step</th> <th>Temperature (°C)</th> </tr> </thead> <tbody> <tr> <td>1</td> <td>25±2 (20±2 for SL char.)</td> </tr> <tr> <td>2</td> <td>Min. Operating Temp.±3</td> </tr> <tr> <td>3</td> <td>25±2 (20±2 for SL char.)</td> </tr> <tr> <td>4</td> <td>Max. Operating Temp.±2</td> </tr> <tr> <td>5</td> <td>25±2 (20±2 for SL char.)</td> </tr> </tbody> </table> SL char. : The capacitance should be measured at even 85°C between step 3 and step 4. •Pretreatment for X7R char. Perform a heat treatment at 150±1°C for 60±5 min. and then let sit for 24±2 hrs. at room condition.*1	Step	Temperature (°C)	1	25±2 (20±2 for SL char.)	2	Min. Operating Temp.±3	3	25±2 (20±2 for SL char.)	4	Max. Operating Temp.±2	5	25±2 (20±2 for SL char.)
Char.	Capacitance Change																						
X7R	Within ±15%																						
Char.	Temperature Coefficient																						
SL	+350 to -1000ppm/°C																						
Step	Temperature (°C)																						
1	25±2 (20±2 for SL char.)																						
2	Min. Operating Temp.±3																						
3	25±2 (20±2 for SL char.)																						
4	Max. Operating Temp.±2																						
5	25±2 (20±2 for SL char.)																						
10	Appearance	No defects or abnormalities	As in Fig., discharge is made 50 times at 5 sec. intervals from the capacitor (Cd) charged at DC voltage of specified.  Ct: Capacitor under test Cd: 0.001µF R1: 1,000Ω R2: 100MΩ R3: Surge resistance																				
	I.R.	More than 1,000MΩ																					
	Dielectric Strength	In accordance with item No.4																					
11	Adhesive Strength of Termination	No removal of the terminations or other defect should occur.	Solder the capacitor to the testing jig (glass epoxy board) shown in Fig. 1. Then apply 10N force in the direction of the arrow. The soldering should be done using the reflow method and should be conducted with care so that the soldering is uniform and free of defects such as heat shock.  Fig. 1																				

\*1 "Room condition" Temperature: 15 to 35°C, Relative humidity: 45 to 75%, Atmospheric pressure: 86 to 106kPa  
 \*2 "C" expresses nominal capacitance value (pF).

Continued on the following page. ↗

## GA3 Series Specifications and Test Methods

↳ Continued from the preceding page.

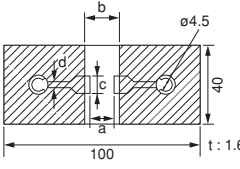
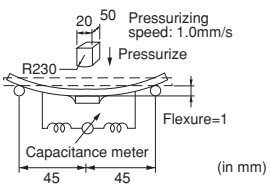
No.	Item	Specifications	Test Method																								
12	Vibration Resistance	Appearance	Solder the capacitor to the test jig (glass epoxy board). The capacitor should be subjected to a simple harmonic motion having a total amplitude of 1.5mm, the frequency being varied uniformly between the approximate limits of 10 and 55Hz. The frequency range, from 10 to 55Hz and return to 10Hz, should be traversed in approximately 1 min. This motion should be applied for a period of 2 hrs. in each of 3 mutually perpendicular directions (total of 6 hrs.).																								
		Capacitance																									
	D.F. Q	<table border="1" style="width: 100%; border-collapse: collapse;"> <thead> <tr style="background-color: #f2f2f2;"> <th style="width: 15%;">Char.</th> <th style="width: 85%;">Specification</th> </tr> </thead> <tbody> <tr> <td>X7R</td> <td>D.F. ≤ 0.025</td> </tr> <tr> <td>SL</td> <td>Q ≥ 400 + 20C*2 (C &lt; 30pF) Q ≥ 1000 (C ≥ 30pF)</td> </tr> </tbody> </table>	Char.	Specification	X7R	D.F. ≤ 0.025	SL	Q ≥ 400 + 20C*2 (C < 30pF) Q ≥ 1000 (C ≥ 30pF)																			
Char.	Specification																										
X7R	D.F. ≤ 0.025																										
SL	Q ≥ 400 + 20C*2 (C < 30pF) Q ≥ 1000 (C ≥ 30pF)																										
13	Deflection	No marking defects	Solder the capacitor to the testing jig (glass epoxy board) shown in Fig. 2. Then apply a force in the direction shown in Fig. 3. The soldering should be done using the reflow method and should be conducted with care so that the soldering is uniform and free of defects such as heat shock.																								
		 <p style="text-align: center;">Fig. 2</p> <table border="1" style="width: 100%; border-collapse: collapse;"> <thead> <tr style="background-color: #f2f2f2;"> <th style="width: 15%;">L×W (mm)</th> <th colspan="4">Dimension (mm)</th> </tr> <tr style="background-color: #f2f2f2;"> <th></th> <th>a</th> <th>b</th> <th>c</th> <th>d</th> </tr> </thead> <tbody> <tr> <td>4.5×2.0</td> <td>3.5</td> <td>7.0</td> <td>2.4</td> <td rowspan="4" style="text-align: center; vertical-align: middle;">1.0</td> </tr> <tr> <td>4.5×3.2</td> <td>3.5</td> <td>7.0</td> <td>3.7</td> </tr> <tr> <td>5.7×2.8</td> <td>4.5</td> <td>8.0</td> <td>3.2</td> </tr> <tr> <td>5.7×5.0</td> <td>4.5</td> <td>8.0</td> <td>5.6</td> </tr> </tbody> </table>		L×W (mm)	Dimension (mm)					a	b	c	d	4.5×2.0	3.5	7.0	2.4	1.0	4.5×3.2	3.5	7.0	3.7	5.7×2.8	4.5	8.0	3.2	5.7×5.0
L×W (mm)	Dimension (mm)																										
	a	b	c	d																							
4.5×2.0	3.5	7.0	2.4	1.0																							
4.5×3.2	3.5	7.0	3.7																								
5.7×2.8	4.5	8.0	3.2																								
5.7×5.0	4.5	8.0	5.6																								
		 <p style="text-align: center;">Fig. 3</p>																									
14	Solderability of Termination	75% of the terminations are to be soldered evenly and continuously.	Immerse the capacitor in a solution of ethanol (JIS-K-8101) and rosin (JIS-K-5902) (25% rosin in weight proportion). Immerse in solder solution for 2±0.5 sec. Immersing speed: 25±2.5mm/s Temp. of solder: 245±5°C Lead Free Solder (Sn-3.0Ag-0.5Cu) 235±5°C H60A or H63A Eutectic Solder																								
15	Resistance to Soldering Heat	Appearance	Preheat the capacitor as in table. Immerse the capacitor in solder solution at 260±5°C for 10±1 sec. Let sit at room condition*1 for 24±2 hrs., then measure. •Immersing speed: 25±2.5mm/s •Pretreatment for X7R char. Perform a heat treatment at 150±18°C for 60±5 min. and then let sit for 24±2 hrs. at room condition.*1																								
		Capacitance Change																									
		I.R.																									
		Dielectric Strength																									
		In accordance with item No.4	*Preheating <table border="1" style="width: 100%; border-collapse: collapse;"> <thead> <tr style="background-color: #f2f2f2;"> <th style="width: 15%;">Step</th> <th style="width: 45%;">Temperature</th> <th style="width: 40%;">Time</th> </tr> </thead> <tbody> <tr> <td>1</td> <td>100 to 120°C</td> <td>1 min.</td> </tr> <tr> <td>2</td> <td>170 to 200°C</td> <td>1 min.</td> </tr> </tbody> </table>	Step	Temperature	Time	1	100 to 120°C	1 min.	2	170 to 200°C	1 min.															
Step	Temperature	Time																									
1	100 to 120°C	1 min.																									
2	170 to 200°C	1 min.																									

\*1 "Room condition" Temperature: 15 to 35°C, Relative humidity: 45 to 75%, Atmospheric pressure: 86 to 106kPa  
 \*2 "C" expresses nominal capacitance value (pF).

Continued on the following page. ↗

For General Purpose GRM/GRJ/GR3 Series

Only for Applications

AC250V Type GA2 Series

Safety Standard Certified GA3 Series

Product Information

# GA3 Series Specifications and Test Methods

Continued from the preceding page.

No.	Item	Specifications	Test Method						
16	Temperature Cycle	Appearance	No marking defects						
		Capacitance Change	<table border="1"> <thead> <tr> <th>Char.</th> <th>Capacitance Change</th> </tr> </thead> <tbody> <tr> <td>X7R</td> <td>Within ±15%</td> </tr> <tr> <td>SL</td> <td>Within ±2.5% or ±0.25pF (Whichever is larger)</td> </tr> </tbody> </table>	Char.	Capacitance Change	X7R	Within ±15%	SL	Within ±2.5% or ±0.25pF (Whichever is larger)
			Char.	Capacitance Change					
		X7R	Within ±15%						
		SL	Within ±2.5% or ±0.25pF (Whichever is larger)						
D.F. Q	<table border="1"> <thead> <tr> <th>Char.</th> <th>Specification</th> </tr> </thead> <tbody> <tr> <td>X7R</td> <td>D.F. ≤0.05</td> </tr> <tr> <td>SL</td> <td>Q ≥ 400+20C*2 (C &lt; 30pF) Q ≥ 1000 (C ≥ 30pF)</td> </tr> </tbody> </table>	Char.	Specification	X7R	D.F. ≤0.05	SL	Q ≥ 400+20C*2 (C < 30pF) Q ≥ 1000 (C ≥ 30pF)		
	Char.	Specification							
X7R	D.F. ≤0.05								
SL	Q ≥ 400+20C*2 (C < 30pF) Q ≥ 1000 (C ≥ 30pF)								
I.R.	More than 3,000MΩ								
Dielectric Strength	In accordance with item No.4								
17	Humidity (Steady State)	Appearance	No marking defects						
		Capacitance Change	<table border="1"> <thead> <tr> <th>Char.</th> <th>Capacitance Change</th> </tr> </thead> <tbody> <tr> <td>X7R</td> <td>Within ±15%</td> </tr> <tr> <td>SL</td> <td>Within ±5.0% or ±0.5pF (Whichever is larger)</td> </tr> </tbody> </table>	Char.	Capacitance Change	X7R	Within ±15%	SL	Within ±5.0% or ±0.5pF (Whichever is larger)
			Char.	Capacitance Change					
		X7R	Within ±15%						
		SL	Within ±5.0% or ±0.5pF (Whichever is larger)						
D.F. Q	<table border="1"> <thead> <tr> <th>Char.</th> <th>Specification</th> </tr> </thead> <tbody> <tr> <td>X7R</td> <td>D.F. ≤0.05</td> </tr> <tr> <td>SL</td> <td>Q ≥ 275+5/2C*2 (C &lt; 30pF) Q ≥ 350 (C ≥ 30pF)</td> </tr> </tbody> </table>	Char.	Specification	X7R	D.F. ≤0.05	SL	Q ≥ 275+5/2C*2 (C < 30pF) Q ≥ 350 (C ≥ 30pF)		
	Char.	Specification							
X7R	D.F. ≤0.05								
SL	Q ≥ 275+5/2C*2 (C < 30pF) Q ≥ 350 (C ≥ 30pF)								
I.R.	More than 3,000MΩ								
Dielectric Strength	In accordance with item No.4								
18	Life	Appearance	No marking defects						
		Capacitance Change	<table border="1"> <thead> <tr> <th>Char.</th> <th>Capacitance Change</th> </tr> </thead> <tbody> <tr> <td>X7R</td> <td>Within ±20%</td> </tr> <tr> <td>SL</td> <td>Within ±3.0% or ±0.3pF (Whichever is larger)</td> </tr> </tbody> </table>	Char.	Capacitance Change	X7R	Within ±20%	SL	Within ±3.0% or ±0.3pF (Whichever is larger)
			Char.	Capacitance Change					
		X7R	Within ±20%						
		SL	Within ±3.0% or ±0.3pF (Whichever is larger)						
D.F. Q	<table border="1"> <thead> <tr> <th>Char.</th> <th>Specification</th> </tr> </thead> <tbody> <tr> <td>X7R</td> <td>D.F. ≤0.05</td> </tr> <tr> <td>SL</td> <td>Q ≥ 275+5/2C*2 (C &lt; 30pF) Q ≥ 350 (C ≥ 30pF)</td> </tr> </tbody> </table>	Char.	Specification	X7R	D.F. ≤0.05	SL	Q ≥ 275+5/2C*2 (C < 30pF) Q ≥ 350 (C ≥ 30pF)		
	Char.	Specification							
X7R	D.F. ≤0.05								
SL	Q ≥ 275+5/2C*2 (C < 30pF) Q ≥ 350 (C ≥ 30pF)								
I.R.	More than 3,000MΩ								
Dielectric Strength	In accordance with item No.4								

Fix the capacitor to the supporting jig (glass epoxy board) shown in Fig. 4.  
 Perform the 5 cycles according to the 4 heat treatments listed in the following table.  
 Let sit for 24±2 hrs. at room condition,\*1 then measure.

Step	Temperature (°C)	Time (min.)
1	Min. Operating Temp.±3	30±3
2	Room Temp.	2 to 3
3	Max. Operating Temp.±2	30±3
4	Room Temp.	2 to 3

•Pretreatment for X7R char.  
 Perform a heat treatment at 150±1,8°C for 60±5 min. and then let sit for 24±2 hrs. at room condition.\*1

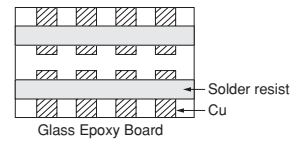

Fig. 4

Before this test, the test shown in the following is performed.  
 ·Item 11 Adhesive Strength of Termination (applied force is 5N)  
 ·Item 13 Deflection

Let the capacitor sit at 40±2°C and relative humidity of 90 to 95% for 500±24 hrs.  
 Remove and let sit for 24±2 hrs. at room condition,\*1 then measure.

•Pretreatment for X7R char.  
 Perform a heat treatment at 150±1,8°C for 60±5 min. and then let sit for 24±2 hrs. at room condition.\*1

Before this test, the test shown in the following is performed.  
 ·Item 11 Adhesive Strength of Termination (apply force is 5N)  
 ·Item 13 Deflection

Impulse Voltage  
 Each individual capacitor should be subjected to a 2.5kV (Type GC/GF: 5kV) Impulse (the voltage value means zero to peak) for three times. Then the capacitors are applied to life test.

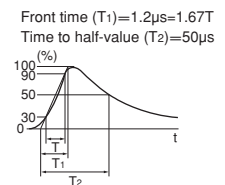

Apply voltage as in Table for 1,000 hrs. at 125±8°C, relative humidity 50% max.

Type	Applied Voltage
GB	AC312.5V (r.m.s.), except that once each hour the voltage is increased to AC1,000V (r.m.s.) for 0.1 sec.
GC	AC425V (r.m.s.), except that once each hour the voltage is increased to AC1,000V (r.m.s.) for 0.1 sec.
GF	
GD	

Let sit for 24±2 hrs. at room condition,\*1 then measure.  
 •Pretreatment for X7R char.  
 Perform a heat treatment at 150±1,8°C for 60±5 min. and then let sit for 24±2 hrs. at room condition.\*1

\*1 "Room condition" Temperature: 15 to 35°C, Relative humidity: 45 to 75%, Atmospheric pressure: 86 to 106kPa

\*2 "C" expresses nominal capacitance value (pF).

Continued on the following page. ↗



# GRM/GRJ/GR3/GR4/GR7/GA2/GA3 Series Reference Data (Typical Example)

## ■ Capacitance - Temperature Characteristics

C0G/U2J/SL Characteristics

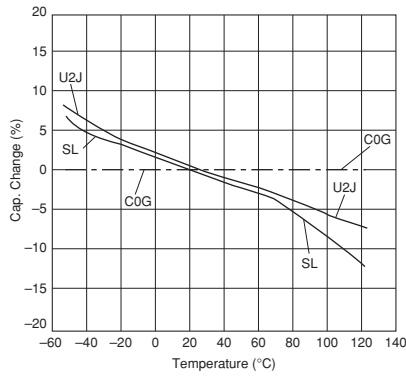

X7R Characteristics

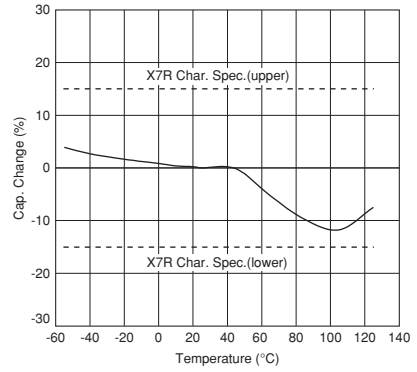

GR4 Series

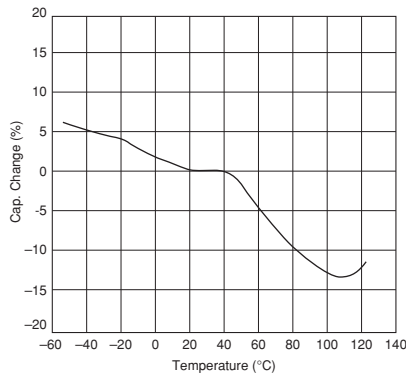

X7T Characteristics

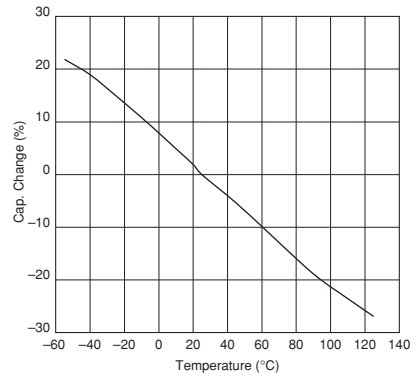

## ■ Impedance - Frequency Characteristics

GRM Series (C0G Char. 250V)

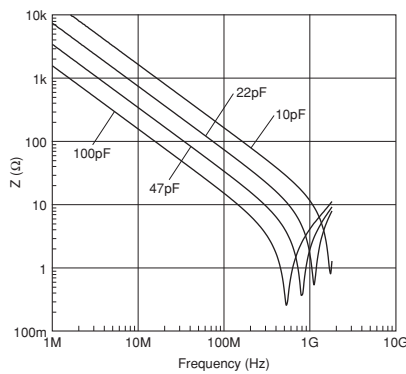

GRM Series (C0G Char. 630V)

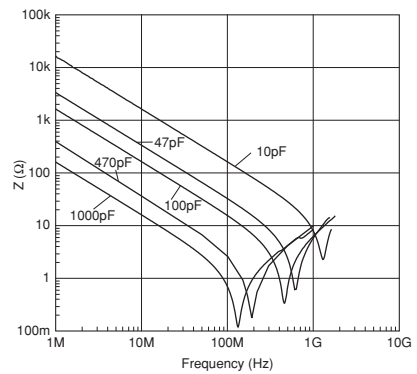

Continued on the following page.

For General Purpose GRM/GRJ/GR3 Series  
 Only for Applications  
 AC250V Type GA2 Series  
 Safety Standard Certified GA3 Series  
 Product Information Reference Data



# GRM/GRJ/GR3/GR4/GR7/GA2/GA3 Series Reference Data (Typical Example)

Continued from the preceding page.

## Impedance - Frequency Characteristics

GRM Series (C0G Char. 1kV)

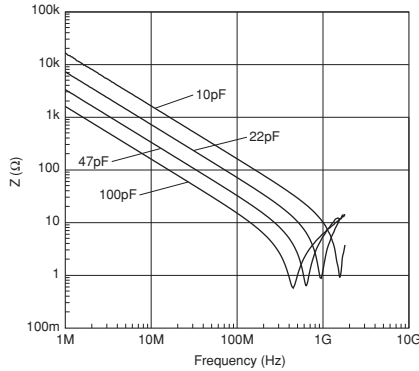

GRM Series (X7R Char. 250V)

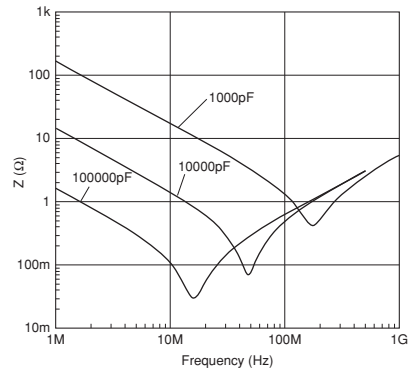

GRM Series (X7R Char. 630V)

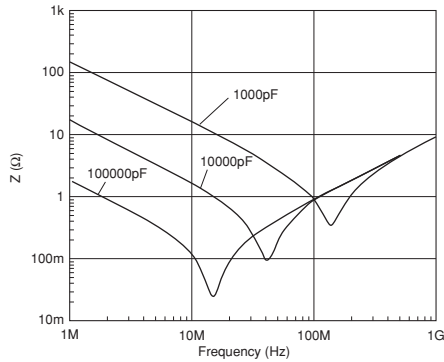

GRJ Series (X7R Char. 250V)

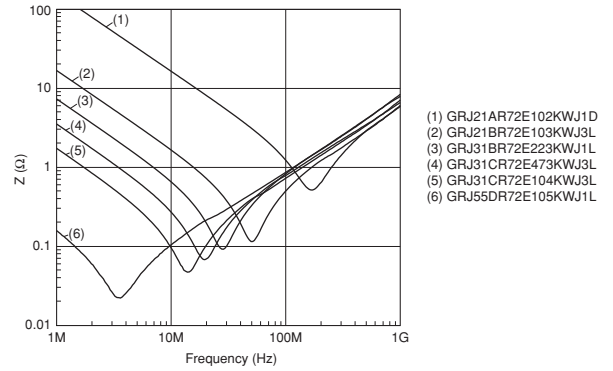

GR3 Series (X7T Char. 250V)

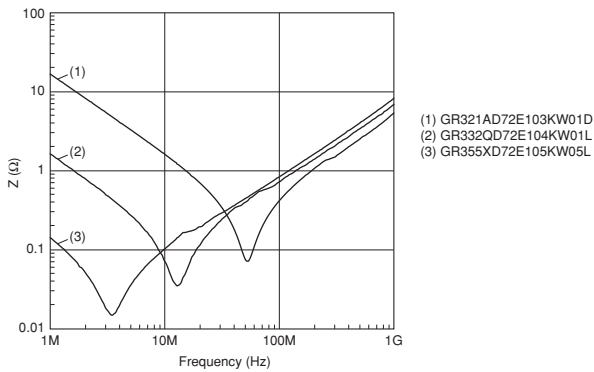

GR4 Series

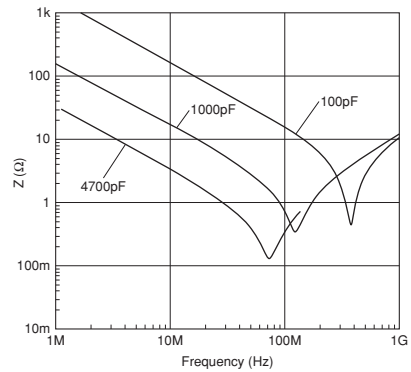

GA2 Series

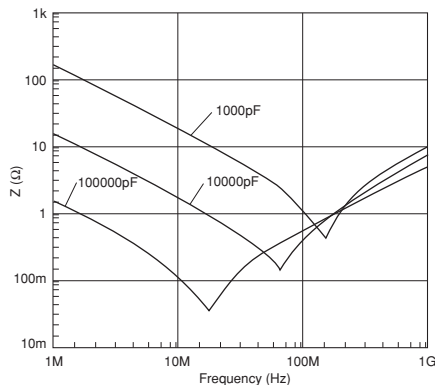

GA3 Series (Type GF)

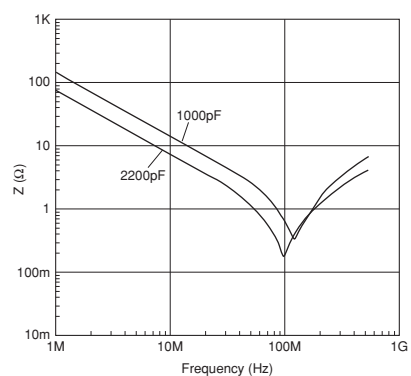

Continued on the following page. ↗

# GRM/GRJ/GR3/GR4/GR7/GA2/GA3 Series Reference Data (Typical Example)

Continued from the preceding page.

## Impedance - Frequency Characteristics

GA3 Series (Type GD)

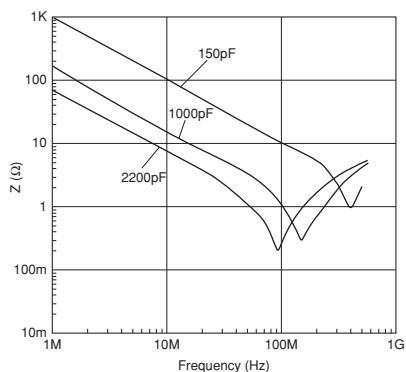

GA3 Series (Type GB)

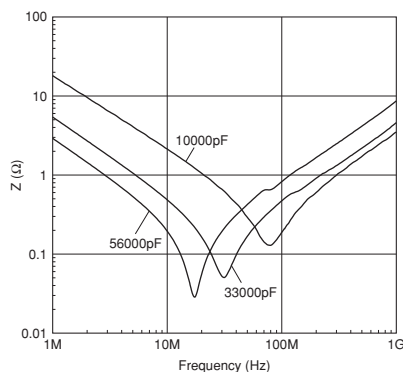

## Capacitance - AC Voltage Characteristics

GA3 Series (Type GF/GD, X7R Char.)

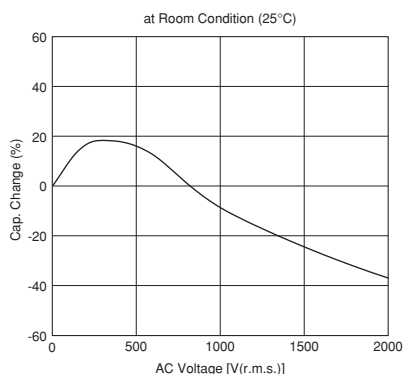

GA3 Series (Type GB)

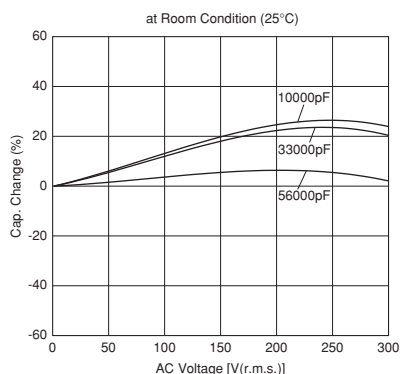

## Capacitance - DC Bias Characteristics

GRM/GR3 Series

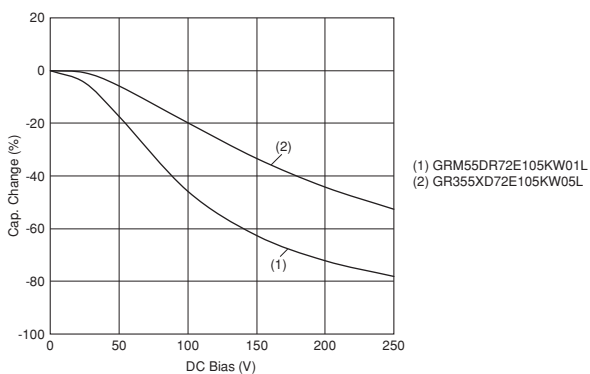

GR7 Series

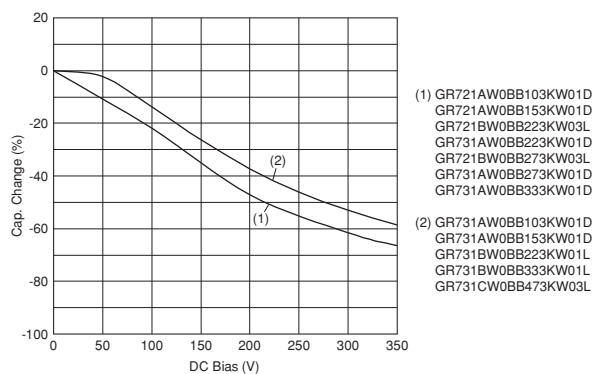

- (1) GR721AW0BB103KW01D  
 GR721AW0BB153KW01D  
 GR721BW0BB223KW03L  
 GR731AW0BB223KW01D  
 GR721BW0BB273KW03L  
 GR731AW0BB273KW01D  
 GR731AW0BB333KW01D
- (2) GR731AW0BB103KW01D  
 GR731AW0BB153KW01D  
 GR731BW0BB223KW01L  
 GR731BW0BB333KW01L  
 GR731CW0BB473KW03L

For General Purpose GRM/GRJ/GR3 Series

Only for Applications

AC250V Type GA2 Series

Safety Standard Certified GA3 Series

Product Information Reference Data

## Package

Taping is the standard packaging method.

### ■ Minimum Quantity Guide

Part Number		Dimensions (mm)			Quantity (pcs.)	
					ø180mm Reel	
		L	W	T	Paper Tape	Embossed Tape
250Vdc min. For General Purpose & Only for Applications	GRM18	1.6	0.8	0.8	4,000	-
	GRJ21/GRM21/GR321/ GR721	2.0	1.25	1.0	4,000	-
				1.25	-	3,000
	GRJ31/GRM31/GR331/ GR731	3.2	1.6	1.0	4,000	-
				1.25	-	3,000
				1.6	-	2,000
	GRJ32/GRM32/GR332	3.2	2.5	1.0	4,000	-
				1.25	-	3,000
				1.5	-	2,000
	GRM42/GR442	4.5	2.0	1.0	-	3,000
				1.5	-	2,000
	GRJ43/GRM43/GR343/ GR443	4.5	3.2	1.5	-	1,000
2.0				-	1,000	
2.5				-	500	
GRM55	5.7	5.0	1.5	-	1,000	
GRJ55/GRM55/GR355/ GR455	5.7	5.0	2.0	-	1,000	
GR355	5.7	5.0	2.7	-	500	
AC250V	GA242	4.5	2.0	1.5	-	2,000
	GA243	4.5	3.2	1.5	-	1,000
				2.0	-	1,000
GA255	5.7	5.0	2.0	-	1,000	
Safety Std. Certification	GA342	4.5	2.0	1.0	-	3,000
				1.5	-	2,000
				2.0	-	2,000
	GA343	4.5	3.2	1.5	-	1,000
				2.0	-	1,000
	GA352	5.7	2.8	1.5	-	1,000
	GA355	5.7	5.0	1.5	-	1,000
				2.0	-	1,000
				2.5	-	500
2.7				-	500	
			2.9	-	500	

Continued on the following page. 

For General Purpose  
GRM/GRJ/GR3 Series

Only for Applications

AC250V Type  
GA2 Series

Safety Standard  
Certified GA3 Series

Product Information  
Package

# Package

Continued from the preceding page.

## ■ Tape Carrier Packaging

### (1) Appearance of Taping

#### ① Embossed Tape

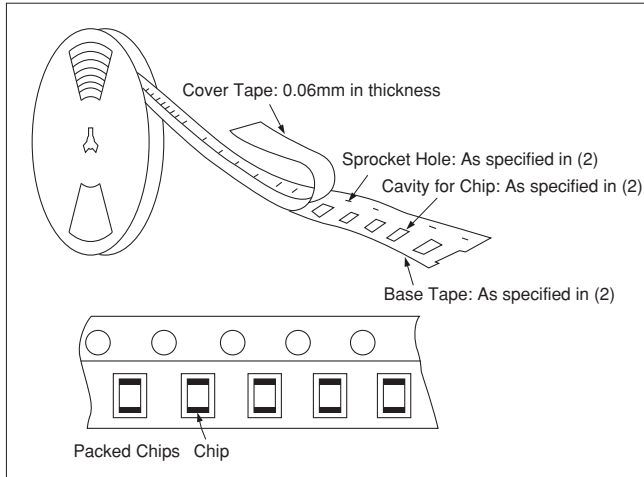

#### ② Paper Tape

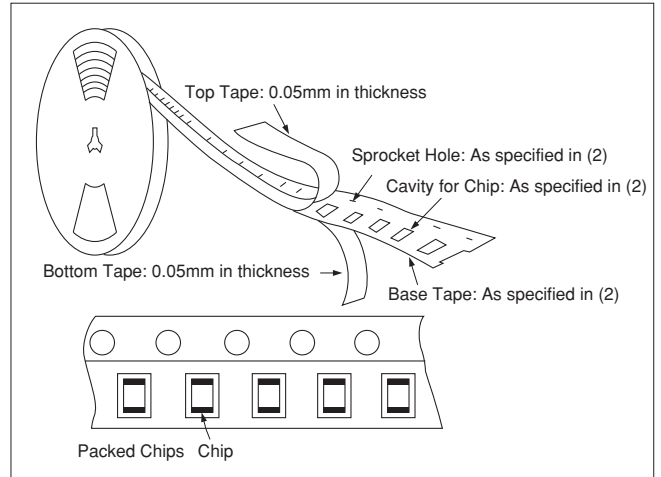

### (2) Dimensions of Tape

#### ① Embossed Tape

8mm width, 4mm pitch Tape

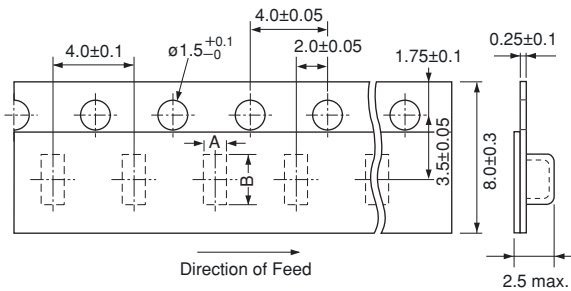

Part Number	A*	B*
GRJ21/GRM21/GR321/GR721 (T≥1.25mm)	1.45	2.25
GRJ31/GRM31/GR331/GR731 (T≥1.25mm)	2.0	3.6
GRJ32/GRM32/GR332 (T≥1.25mm)	2.9	3.6

\*Nominal Value

12mm width, 8mm/4mm pitch Tape

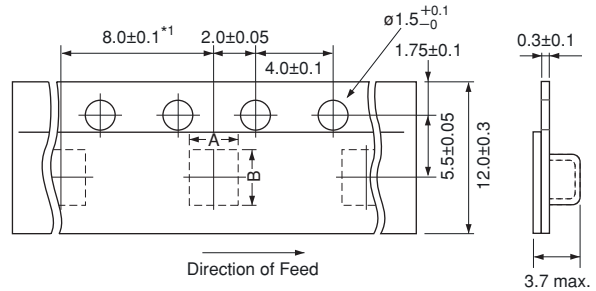

Part Number	A*	B*
GRM42/GR442/GA242/GA342	2.5	5.1
GRJ43/GRM43/GR343/GR443/GA243/GA343	3.6	4.9
GA352	3.2	6.1
GRJ55/GRM55/GR355/GR455/GA255/GA355	5.4	6.1

\*1 4.0±0.1mm in case of GRM42/GR442/GA242/GA342

\*Nominal Value

(in mm)

#### ② Paper Tape

8mm width, 4mm pitch Tape

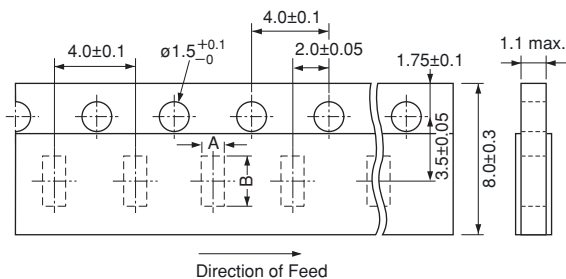

Part Number	A*	B*
GRM18	1.05	1.85
GRJ21/GRM21/GR321/GR721 (T=1.0mm)	1.45	2.25
GRM31/GR331/GR731 (T=1.0mm)	2.0	3.6
GRM32 (T=1.0mm)	2.9	3.6

\*Nominal Value

(in mm)

For General Purpose GRM/GRJ/GR3 Series

Only for Applications

AC250V Type GA2 Series

Safety Standard Certified GA3 Series

Product Information Package

## Package

Continued from the preceding page.

### (3) Dimensions of Reel

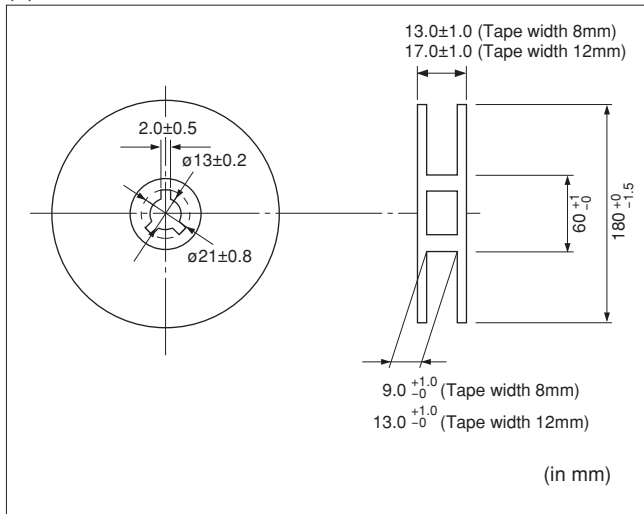

### (4) Taping Method

- ① Tapes for capacitors are wound clockwise. The sprocket holes are to the right as the tape is pulled toward the user.
- ② Part of the leader and part of the empty tape should be attached to the end of the tape as shown at right.
- ③ The top tape or cover tape and base tape are not attached at the end of the tape for a minimum of 5 pitches.
- ④ Missing capacitors number within 0.1% of the number per reel or 1 pc, whichever is greater, and are not continuous.
- ⑤ The top tape or cover tape and bottom tape should not protrude beyond the edges of the tape and should not cover sprocket holes.
- ⑥ Cumulative tolerance of sprocket holes, 10 pitches:  $\pm 0.3\text{mm}$ .
- ⑦ Peeling off force: 0.1 to 0.6N in the direction shown at right.

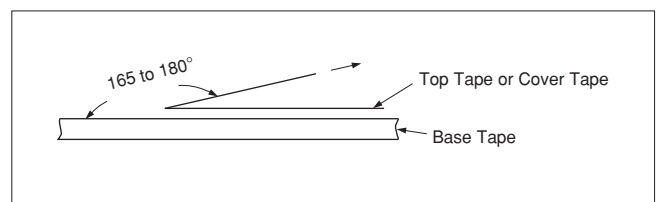
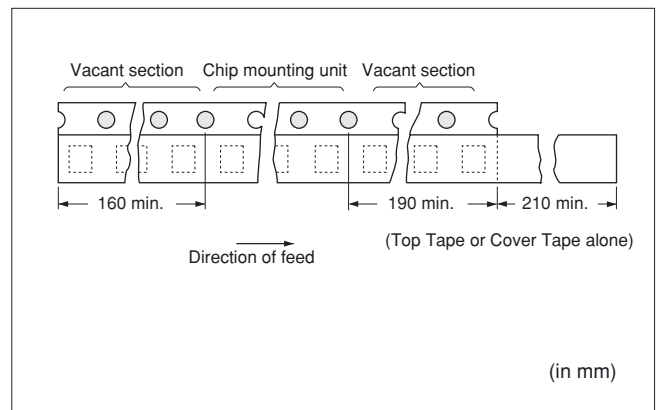

For General Purpose  
 GRM/GRJ/GR3 Series

Only for Applications

AC250V Type  
 GA2 Series

Safety Standard  
 Certified GA3 Series

Product Information  
 Package

## ⚠Caution/Notice

### ⚠Caution

### Notice

- Storage and Operation Conditions ..... 189
- Rating ..... 189
  - 1. Operating Voltage ..... 189
  - 2. Operating Temperature, Self-generated Heat, and Load Reduction at High-frequency Voltage Condition ..... 189
  - 3. Fail-safe ..... 191
  - 4. Test Condition for AC Withstanding Voltage ..... 191
    - (1) Test Equipment ..... 191
    - (2) Voltage Applied Method ..... 191
- Soldering and Mounting ..... 191
  - 1. Vibration and Impact ..... 191
  - 2. Circuit Board Material ..... 191
  - 3. Land Layout for Cropping PC Board ..... 191
  - 4. Reflow Soldering ..... 192
  - 5. Flow Soldering ..... 193
  - 6. Correction with a Soldering Iron ..... 194
  - 7. Washing ..... 194
  - 8. Handling ..... 194

- Rating ..... 195
  - 1. Capacitance Change of Capacitor ..... 195
  - 2. Performance Check by Equipment ..... 195
- Soldering and Mounting ..... 195
  - 1. Construction of Board Pattern ..... 195
  - 2. Mounting of Chips ..... 196
  - 3. Soldering ..... 197
    - (1) Limit of losing effective area of the terminations and conditions needed for soldering. .... 197
    - (2) Flux Application ..... 197
    - (3) Solder ..... 197
  - 4. Cleaning ..... 197
  - 5. Resin Coating ..... 197

For General Purpose GRM/GRJ/GR3 Series  
 Only for Applications  
 AC250V Type GA2 Series  
 Safety Standard Certified GA3 Series  
 Product Information ⚠Caution/Notice



**⚠Caution**

**■ Storage and Operation Conditions**

Do not use or store capacitors in a corrosive atmosphere, especially where chloride gas, sulfide gas, acid, alkali, salt or the like are present. In addition, avoid exposure to moisture. Before cleaning, bonding or molding this product, verify that these processes do not affect product quality by testing the performance of a cleaned, bonded or molded product in the intended equipment. Store the capacitors where the temperature and relative humidity do not exceed 5 to 40 degrees centigrade and 20 to 70%. Use capacitors within 6 months of delivery. Check the solderability after 6 months or more.

**■ Rating**

**1. Operating Voltage**

When DC-rated capacitors are to be used in AC or ripple current circuits, be sure to maintain the  $V_{p-p}$  value of the applied voltage or the  $V_{0-p}$  which contains DC bias within the rated voltage range.

When the voltage is applied to the circuit, starting or stopping may generate irregular voltage for a transit period because of resonance or switching. Be sure to use a capacitor with a rated voltage range that includes these irregular voltages.

When DC-rated capacitors are to be used in input circuits from a commercial power source (AC filter), be sure to use Safety Certified Capacitors because various regulations for withstanding voltage or impulses, established for all equipment, should be taken into consideration.

Voltage	DC Voltage	DC+AC Voltage	AC Voltage	Pulse Voltage (1)	Pulse Voltage (2)
Positional Measurement					

**2. Operating Temperature, Self-generated Heat, and Load Reduction at High-frequency Voltage Condition**

Keep the surface temperature of a capacitor below the upper limit of its rated operating temperature range. Be sure to take into account the heat generated by the capacitor itself. When the capacitor is used in a high-frequency voltage, pulse voltage, it may self-generate heat due to dielectric loss.

**(1) In the case of X7R, X7T char.**

Applied voltage should be the load such as self-generated heat is within 20°C on the condition of atmosphere temperature 25°C. When measuring, use a thermocouple of small thermal capacity -K of  $\phi 0.1$ mm in conditions where the capacitor is not affected by radiant heat from other components or surrounding ambient fluctuations. Excessive heat may lead to deterioration of the capacitor's characteristics and reliability. (Never attempt to perform measurement with the cooling fan running. Otherwise, accurate measurement cannot be ensured.)

Continued on the following page.

For General Purpose  
GRM/GRJ/GR3 Series

Only for Applications

AC250V Type  
GA2 Series

Safety Standard  
Certified GA3 Series

Product Information  
⚠Caution

**⚠Caution**

↳ Continued from the preceding page.

**(2) In case of C0G, U2J char.**

Due to the low self-heating characteristics of low-dissipation capacitors, the allowable electric power of these capacitors is generally much higher than that of X7R characteristic capacitors.

When a high frequency voltage that causes 20°C self-heating to the capacitor is applied, it will exceed the capacitor's allowable electric power.

The frequency of the applied sine wave voltage should be less than 500kHz (less than 100kHz in the case of rated voltage: DC3.15kV). The applied voltage should be less than the value shown in figure below.

In the case of non-sine wave that includes a harmonic frequency, please contact our sales representatives or product engineers. Excessive heat may lead to deterioration of the capacitor's characteristics and reliability. (Never attempt to perform measurement with the cooling fan running. Otherwise, accurate measurement cannot be ensured.)

<C0G char., Rated Voltage: DC3.15kV>

The capacitors less than 22pF can be applied maximum 4.0kV peak to peak at 100kHz or less only for the ballast or the resonance usage in the LCD backlight inverter circuit.

<Capacitor Selection Tool>

We are also offering free software/the capacitor selection tool: "Murata Medium Voltage Capacitors Selection Tool by Voltage Form," which will assist you in selecting a suitable capacitor.

The software can be downloaded from Murata's Website. (<http://www.murata.com/designlib/mmcsv/index.html>). By inputting capacitance values and the applied voltage waveform of the specific capacitor series, this software will calculate the capacitor's power consumption and list suitable capacitors (non-sine wave is also available).

The temperature of the surface of capacitor: 125°C or less (including self-heating)

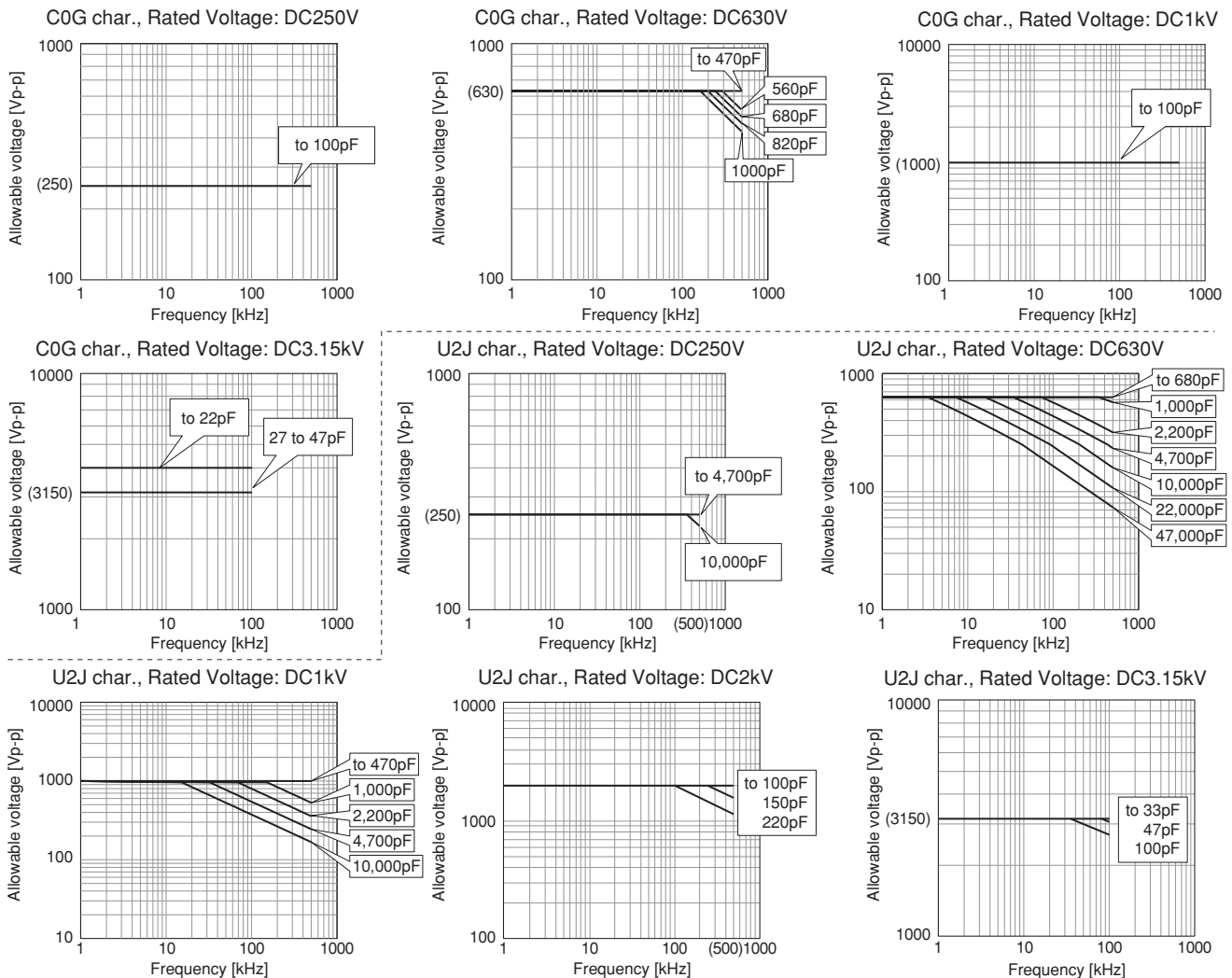

The sine-wave frequency VS allowable voltage

Continued on the following page. ↗

For General Purpose GRM/GRU/GR3 Series

Only for Applications

AC250V Type GA2 Series

Safety Standard Certified GA3 Series

Product Information ⚠Caution

**⚠Caution**

☐ Continued from the preceding page.

**3. Fail-safe**

Failure of a capacitor may result in a short circuit. Be sure to provide an appropriate fail-safe function such as a fuse on your product to help eliminate possible electric shock, fire, or fumes.

Please consider using fuses on each AC line if the capacitors are used between the AC input lines and earth (line bypass capacitors), to prepare for the worst case, such as a short circuit.

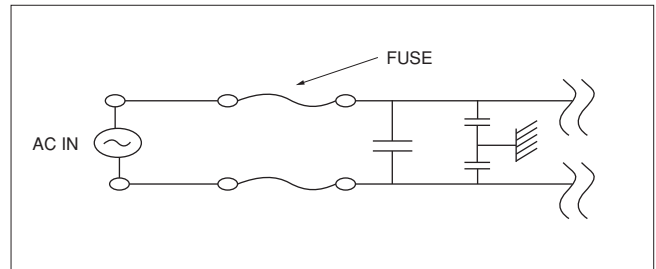

**4. Test Condition for AC Withstanding Voltage**

**(1) Test Equipment**

Tests for AC withstanding voltage should be made with equipment capable of creating a wave similar to a 50/60 Hz sine wave.

If the distorted sine wave or overload exceeding the specified voltage value is applied, a defect may be caused.

\*ZERO CROSS is the point where voltage sine wave passes 0V.

- See the figure at right -

**(2) Voltage Applied Method**

The capacitor's leads or terminals should be firmly connected to the output of the withstanding voltage test equipment, and then the voltage should be raised from near zero to the test voltage. If the test voltage is applied directly to the capacitor without raising it from near zero, it should be applied with the zero cross.\* At the end of the test time, the test voltage should be reduced to near zero, and then the capacitor's leads or terminals should be taken off the output of the withstanding voltage test equipment. If the test voltage is applied directly to the capacitor without raising it from near zero, surge voltage may occur and cause a defect.

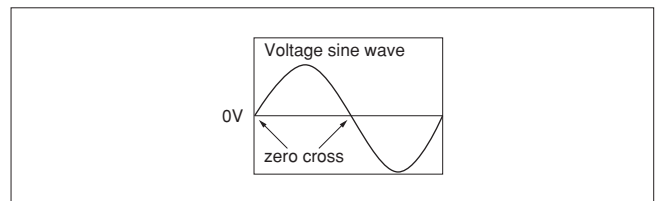

**■ Soldering and Mounting**

**1. Vibration and Impact**

Do not expose a capacitor to excessive shock or vibration during use.

**2. Circuit Board Material**

It is possible for the chip to crack by the expansion and shrinkage of a metal board.

Please contact us if you want to use our ceramic capacitors on a metal board such as Aluminum.

**3. Land Layout for Cropping PC Board**

Choose a mounting position that minimizes the stress imposed on the chip during flexing or bending of the board.

**[Component Direction]**

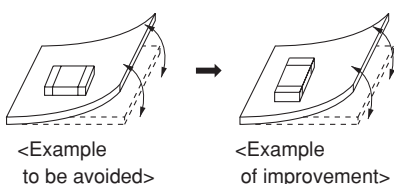

Locate chip horizontal to the direction in which stress acts.

**[Chip Mounting Close to Board Separation Point]**

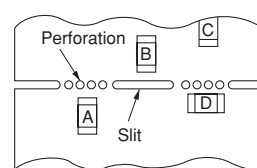

Chip arrangement Worst A>C>B~D Best

Continued on the following page. ↗

**⚠Caution**

Continued from the preceding page.

**4. Reflow Soldering**

- When components are exposed to sudden heat, their mechanical strength can be decreased due to the extreme temperature changes which can cause flexing and result in internal mechanical damage, which will cause the parts to fail. In order to prevent mechanical damage, preheating is required for both the components and the PCB board. Preheating conditions are shown in Table 1. It is required to keep the temperature differential between the soldering and the components surface ( $\Delta T$ ) as small as possible.
- Solderability of Tin plating termination chips might be deteriorated when low temperature soldering profile where peak solder temperature is below the Tin melting point is used. Please confirm the solderability of Tin plating termination chips before use.
- When components are immersed in solvent after mounting, be sure to maintain the temperature difference ( $\Delta T$ ) between the component and solvent within the range shown in the Table 1.

**Table 1**

Part Number	Temperature Differential
G□□18/21/31	$\Delta T \leq 190^\circ\text{C}$
G□□32/42/43/52/55	$\Delta T \leq 130^\circ\text{C}$

**Recommended Conditions**

	Pb-Sn Solder		Lead Free Solder
	Infrared Reflow	Vapor Reflow	
Peak Temperature	230-250°C	230-240°C	240-260°C
Atmosphere	Air	Air	Air or N <sub>2</sub>

Pb-Sn Solder: Sn-37Pb  
 Lead Free Solder: Sn-3.0Ag-0.5Cu

**[Standard Conditions for Reflow Soldering]**

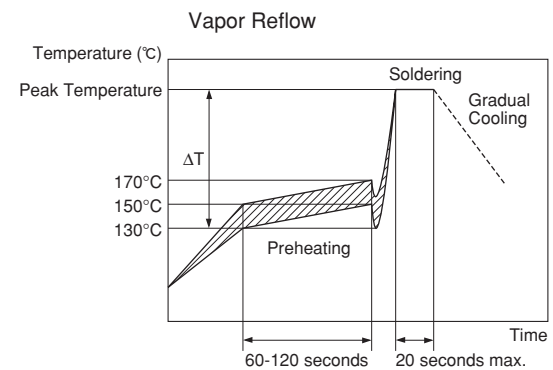
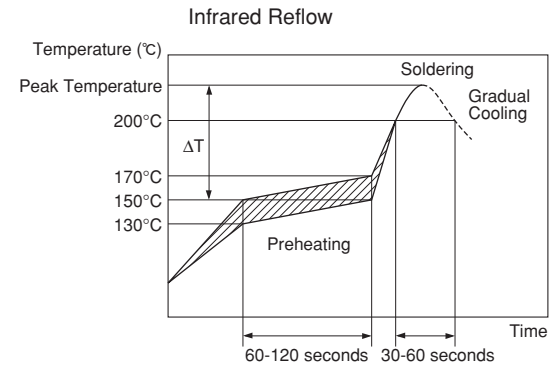

**[Allowable Soldering Temperature and Time]**

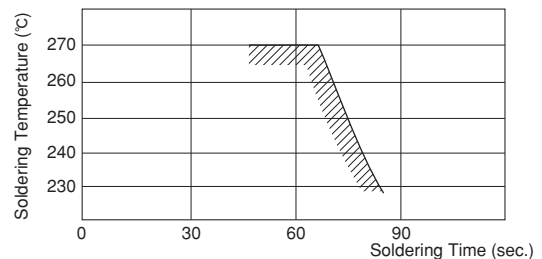

In the case of repeated soldering, the accumulated soldering time must be within the range shown above.

**Optimum Solder Amount for Reflow Soldering**

- Overly thick application of solder paste results in excessive solder fillet height. This makes the chip more susceptible to mechanical and thermal stress on the board and may cause cracked chips.
- Too little solder paste results in a lack of adhesive strength on the outer electrode, which may result in chips breaking loose from the PCB.
- Make sure the solder has been applied smoothly to the end surface to a height of 0.2mm min.

**[Optimum Solder Amount for Reflow Soldering]**

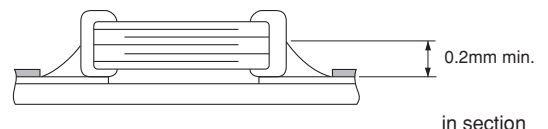

**Inverting the PCB**

Make sure not to impose an abnormal mechanical shock on the PCB.

Continued on the following page. ↗

For General Purpose GRM/GRU/GR3 Series  
 Only for Applications  
 AC250V Type GA2 Series  
 Safety Standard Certified GA3 Series  
 Product Information ⚠Caution

**⚠Caution**

☐ Continued from the preceding page.

**5. Flow Soldering**

- When components are exposed to sudden heat, their mechanical strength can be decreased due to the extreme temperature changes which can cause flexing and result in internal mechanical damage, which will cause the parts to fail. Additionally, an excessively long soldering time or high soldering temperature results in leaching by the outer electrodes, causing poor adhesion or a reduction in capacitance value due to loss of contact between electrodes and end termination.
- In order to prevent mechanical damage, preheating is required for both the components and the PCB board. Preheating conditions are shown in Table 2. It is required to keep temperature differential between the soldering and the components surface ( $\Delta T$ ) as small as possible.
- When components are immersed in solvent after mounting, be sure to maintain the temperature difference between the component and solvent within the range shown in Table 2.  
 Do not apply flow soldering to chips not listed in Table 2.

**Table 2**

Part Number	Temperature Differential
G□□18/21/31	$\Delta T \leq 150^\circ\text{C}$

**Recommended Conditions**

	Pb-Sn Solder	Lead Free Solder
Peak Temperature	240-250°C	250-260°C
Atmosphere	Air	N <sub>2</sub>

Pb-Sn Solder: Sn-37Pb  
 Lead Free Solder: Sn-3.0Ag-0.5Cu

- **Optimum Solder Amount for Flow Soldering**  
 The top of the solder fillet should be lower than the thickness of components. If the solder amount is excessively large, the risk of cracking is higher during board bending or under any other stressful conditions.

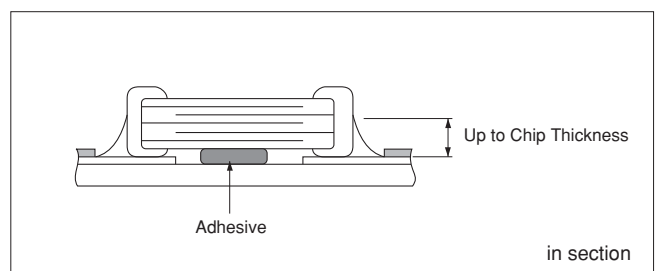
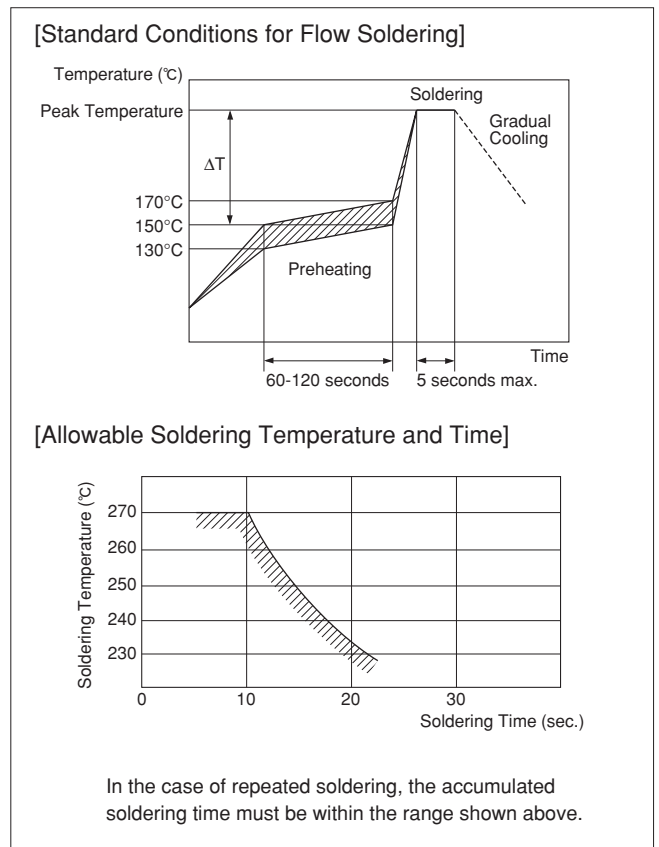

Continued on the following page. ☐

For General Purpose  
 GRM/GRJ/GR3 Series

Only for Applications

AC250V Type  
 GA2 Series

Safety Standard  
 Certified GA3 Series

Product Information  
 ⚠Caution

## ⚠Caution

☐ Continued from the preceding page.

### 6. Correction with a Soldering Iron

- When sudden heat is applied to the components by use of a soldering iron, the mechanical strength of the components will decrease because the extreme temperature change causes deformations inside the components.

In order to prevent mechanical damage to the components, preheating is required for both the components and the PCB board.

Preheating conditions, (The "Temperature of the Soldering Iron Tip", "Preheating Temperature," "Temperature Differential" between iron tip and the

components and the PCB), should be within the conditions of table 3.

It is required to keep the temperature differential between the soldering Iron and the component's surface ( $\Delta T$ ) as small as possible.

After soldering, do not allow the component/PCB to cool down rapidly.

The operating time for the re-working should be as short as possible. When re-working time is too long, it may cause solder leaching, in turn causing a reduction of the adhesive strength of the terminations.

Table 3

Part Number	Temperature of Soldering Iron Tip	Preheating Temperature	Temperature Differential ( $\Delta T$ )	Atmosphere
G□□18/21/31	350°C max.	150°C min.	$\Delta T \leq 190^\circ\text{C}$	air
G□□32/42/43/52/55	280°C max.	150°C min.	$\Delta T \leq 130^\circ\text{C}$	air

\*Applicable for both Pb-Sn and Lead Free Solder.  
 Pb-Sn Solder: Sn-37Pb  
 Lead Free Solder: Sn-3.0Ag-0.5Cu

- Optimum Solder Amount when re-working Using a Soldering Iron

For sizes smaller than G□□18, the top of the solder fillet should be lower than 2/3 of the thickness of the component or 0.5mm whichever is smaller.

For sizes larger than G□□21, the top of the solder fillet should be lower than 2/3 of the thickness of the component.

If the solder amount is excessive, the risk of cracking is higher during board bending or under any other stressful conditions.

A Soldering iron  $\phi 3\text{mm}$  or smaller should be used.

It is also necessary to keep the soldering iron from touching the components during the re-work.

Solder wire with  $\phi 0.5\text{mm}$  or smaller is required for soldering.

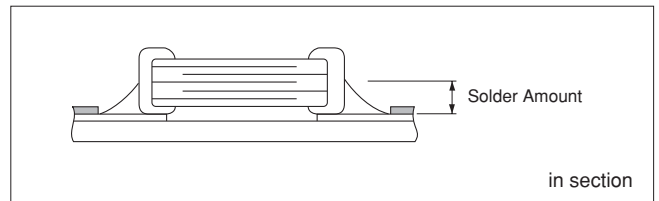

### 7. Washing

Excessive output of ultrasonic oscillation during cleaning causes PCBs to resonate, resulting in cracked chips or broken solder. Take note not to vibrate PCBs.

### 8. Handling

Do not directly touch the chip capacitor, especially the ceramic body. Residue from hands/fingers may create a short circuit environment.

**FAILURE TO FOLLOW THE ABOVE CAUTIONS MAY RESULT, WORST CASE, IN A SHORT CIRCUIT AND FUMING WHEN THE PRODUCT IS USED.**

For General Purpose GRM/GRJ/GR3 Series  
 Only for Applications  
 AC250V Type GA2 Series  
 Safety Standard Certified GA3 Series  
 Product Information ⚠Caution



**Notice**

**Rating**

**1. Capacitance Change of Capacitor**

(1) In the case of X7R, X7T char.

Capacitors have an aging characteristic, whereby the capacitor continually decreases its capacitance slightly if the capacitor is left on for a long time. Moreover, capacitance might change greatly depending on the surrounding temperature or an applied voltage. Therefore, it is not likely to be suitable for use in a time constant circuit. Please contact us if you need detailed information.

(2) In the case of any char. except X7R, X7T

Capacitance might change a little depending on the surrounding temperature or an applied voltage. Please contact us if you intend to use this product in a strict time constant circuit.

**2. Performance Check by Equipment**

Before using a capacitor, check that there is no problem in the equipment's performance and the specifications.

Generally speaking, CLASS 2 (X7R, X7T char.) ceramic capacitors have voltage dependence characteristics and temperature dependence characteristics in capacitance. Therefore, the capacitance value may change depending on the operating condition in the equipment.

Accordingly, be sure to confirm the apparatus performance of receiving influence in a capacitance value change of a capacitor, such as leakage current and noise suppression characteristics.

Moreover, check the surge-proof ability of a capacitor in the equipment, if needed, because the surge voltage may exceed the specific value by the inductance of the circuit.

**Soldering and Mounting**

**1. Construction of Board Pattern**

After installing chips, if solder is excessively applied to the circuit board, mechanical stress will cause destruction resistance characteristics to lower. To prevent this, be extremely careful in determining shape and dimension before designing the circuit board diagram.

**Construction and Dimensions of Pattern (Example)**

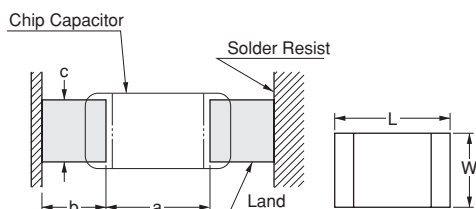

**Flow Soldering**

L×W	a	b	c
1.6×0.8	0.6-1.0	0.8-0.9	0.6-0.8
2.0×1.25	1.0-1.2	0.9-1.0	0.8-1.1
3.2×1.6	2.2-2.6	1.0-1.1	1.0-1.4

Flow soldering: 3.2×1.6 or less available.

**Reflow Soldering**

L×W	a	b	c
1.6×0.8	0.6-0.8	0.6-0.7	0.6-0.8
2.0×1.25	1.0-1.2	0.6-0.7	0.8-1.1
3.2×1.6	2.2-2.4	0.8-0.9	1.0-1.4
3.2×2.5	2.0-2.4	1.0-1.2	1.8-2.3
4.5×2.0	2.8-3.4	1.2-1.4	1.4-1.8
4.5×3.2	2.8-3.4	1.2-1.4	2.3-3.0
5.7×2.8	4.0-4.6	1.4-1.6	2.1-2.6
5.7×5.0	4.0-4.6	1.4-1.6	3.5-4.8

(in mm)

Continued on the following page. ↗

For General Purpose  
GRM/GRJ/GR3 Series

Only for Applications

AC250V Type  
GA2 Series

Safety Standard  
Certified GA3 Series

Product Information  
Notice

## Notice

☐ Continued from the preceding page.

### Dimensions of Slit (Example)

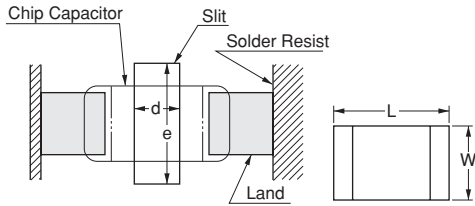

L×W	d	e
1.6×0.8	-	-
2.0×1.25	-	-
3.2×1.6	1.0-2.0	3.2-3.7
3.2×2.5	1.0-2.0	4.1-4.6
4.5×2.0	1.0-2.8	3.6-4.1
4.5×3.2	1.0-2.8	4.8-5.3
5.7×2.8	1.0-4.0	4.4-4.9
5.7×5.0	1.0-4.0	6.6-7.1

(in mm)

Preparing the slit helps flux cleaning and resin coating on the back of the capacitor.

However, the length of the slit design should be as short as possible to prevent mechanical damage in the capacitor.

A longer slit design might receive more severe mechanical stress from the PCB.

Recommended slit design is shown in the Table.

### Land Layout to Prevent Excessive Solder

	Mounting Close to a Chassis	Mounting with Leaded Components	Mounting Leaded Components Later
Examples to Be Avoided			
Examples of Improvements by the Land Division			

## 2. Mounting of Chips

- Thickness of adhesives applied  
 Keep thickness of adhesives applied (50-105μm or more) to reinforce the adhesive contact considering the thickness of the termination or capacitor (20-70μm) and the land pattern (30-35μm).
- Mechanical shock of the chip placer  
 When the positioning claws and pick-up nozzle are worn, the load is applied to the chip while positioning is concentrated in one position, thus causing cracks, breakage, faulty positioning accuracy, etc.  
 Careful checking and maintenance are necessary to prevent unexpected trouble.  
 An excessively low bottom dead point of the suction nozzle imposes great force on the chip during mounting, causing cracked chips. Please set the suction nozzle's bottom dead point on the upper surface of the board.

Continued on the following page. ☐

For General Purpose GRM/GRU/GR3 Series  
 Only for Applications  
 AC250V Type GA2 Series  
 Safety Standard Certified GA3 Series  
 Product Information Notice

## Notice

☐ Continued from the preceding page.

### 3. Soldering

(1) Limit of losing effective area of the terminations and conditions needed for soldering.

Depending on the conditions of the soldering temperature and/or immersion (melting time), effective areas may be lost in some parts of the terminations.

To prevent this, be careful in soldering so that any possible loss of the effective area on the terminations will securely remain at a maximum of 25% on all edge length A-B-C-D-A of part with A, B, C, D, shown in the Figure below.

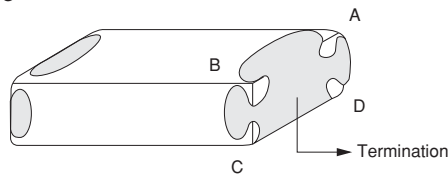

### 4. Cleaning

Please confirm there is no problem in the reliability of the product beforehand when cleaning it with the intended equipment.

The residue after cleaning it might cause a decrease in the surface resistance of the chip and the corrosion of the electrode part, etc. As a result it might cause reliability to deteriorate. Please confirm beforehand that there is no problem with the intended equipment in ultrasonic cleansing.

### 5. Resin Coating

Please use it after confirming there is no influence on the product with the intended equipment before the resin coating and molding.

A cracked chip might be caused at the cooling/heating cycle by the amount of resin spreading and/or bias thickness.

The resin for coating and molding must be selected as the stress is small when stiffening and the hygroscopic is low as possible.

(2) Flux Application

- An excessive amount of flux generates a large quantity of flux gas, causing deteriorated solderability. So apply flux thinly and evenly throughout. (A foaming system is generally used for flow soldering.)
- Flux containing too high a percentage of halide may cause corrosion of the outer electrodes without sufficient cleaning. Use flux with a halide content of 0.2% max.
- Do not use strong acidic flux.
- Do not use water-soluble flux.\*  
(\*Water-soluble flux can be defined as non rosin type flux including wash-type flux and non-wash-type flux.)

(3) Solder

The use of Sn-Zn based solder will deteriorate the reliability of the MLCC.

Please contact our sales representative or product engineers on the use of Sn-Zn based solder in advance.

For General Purpose  
GRW/GRJ/GR3 Series

Only for Applications

AC250V Type  
GA2 Series

Safety Standard  
Certified GA3 Series

Product Information  
Notice

# MEMO

# Contents

## Metal Terminal Monolithic Ceramic Capacitors

---

### For General Purpose KRM/KR3 Series

High Capacitance for General Use KRM Series .....	p200
Large Capacitance and High Allowable Ripple Current Type KR3 Series .....	p204
<hr/>	
Package .....	p208
⚠Caution/Notice .....	p210

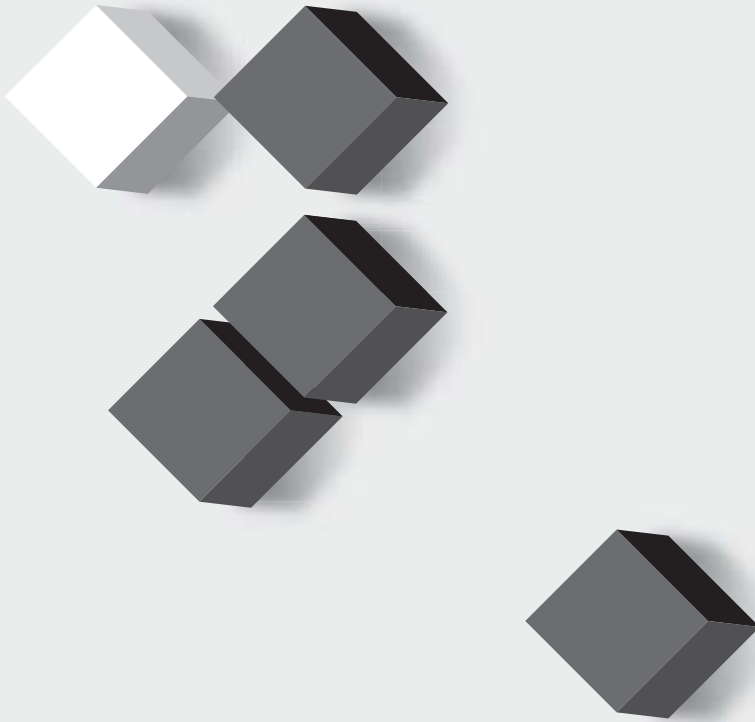

For General Purpose  
KRM/KR3 Series

Product Information

## Metal Terminal Monolithic Ceramic Capacitors

### High Capacitance for General Use KRM Series

**Anti-noise**

**Deflecting crack**

**Soldering crack**

#### ■ Features

1. The product has high reliability against heat and mechanical impact.
2. Stacking two capacitors reduces the mounting space and achieves a large capacitance.
3. The unique terminal structure greatly reduces noise from the ceramics on the board.

#### ■ Applications

For smoothing and noise suppression of DC-DC converters

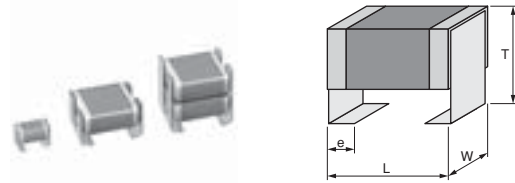

Part Number	Dimensions (mm)			e
	L	W	T	
KRM31F	3.5±0.3	1.7±0.2	1.9±0.1	0.8±0.2
	3.5±0.3	1.7±0.2	2.7±0.2	
	3.6±0.3	1.7±0.2	2.7±0.2	
KRM31K	3.7±0.3	1.85±0.2	2.7±0.2	1.2±0.2
	6.1±0.4	5.3±0.2	2.8±0.2	
KRM55L	6.1±0.4	5.3±0.2	3.7±0.2	1.2±0.2
KRM55Q			4.8±0.2	
KRM55T			4.8±0.2	
KRM55W			6.4±0.3	

Do not use these products in any Automotive Power train or Safety equipment including Battery chargers for Electric Vehicles and Plug-in Hybrids.

Only Murata products clearly stipulated as "for Automotive use" can be used for automobile applications such as Power train and Safety equipment.

Part Number	Rated Voltage	TC Code (Standard)	Capacitance	Length L (mm)	Width W (mm)	Thickness T max. (mm)	Metal Terminal Width e (mm)
KRM31FR61E106KH01K	25Vdc	X5R (EIA)	10μF±10%	3.5	1.7	2	0.8±0.2mm
KRM31KC81E106KH01K	25Vdc	X6S (EIA)	10μF±10%	3.5	1.7	2.9	0.8±0.2mm
KRM55LR71E156KH01K	25Vdc	X7R (EIA)	15μF±10%	6.1	5.3	3	1.2±0.2mm
KRM55QR71E226KH01K	25Vdc	X7R (EIA)	22μF±10%	6.1	5.3	3.9	1.2±0.2mm
KRM55TR71E336MH01K	25Vdc	X7R (EIA)	33μF±20%	6.1	5.3	5	1.2±0.2mm
KRM55WR71E476MH01K	25Vdc	X7R (EIA)	47μF±20%	6.1	5.3	6.7	1.2±0.2mm
KRM31KR71H225KH01K	50Vdc	X7R (EIA)	2.2μF±10%	3.6	1.7	2.9	0.8±0.2mm
KRM31KR71H475KH01K	50Vdc	X7R (EIA)	4.7μF±10%	3.5	1.7	2.9	0.8±0.2mm
KRM55LR71H475KH01K	50Vdc	X7R (EIA)	4.7μF±10%	6.1	5.3	3	1.2±0.2mm
KRM55QR71H106KH01K	50Vdc	X7R (EIA)	10μF±10%	6.1	5.3	3.9	1.2±0.2mm
KRM55WR71H226MH01K	50Vdc	X7R (EIA)	22μF±20%	6.1	5.3	6.7	1.2±0.2mm
KRM55LR71J475KH01K	63Vdc	X7R (EIA)	4.7μF±10%	6.1	5.3	3	1.2±0.2mm
KRM55QR71J106KH01K	63Vdc	X7R (EIA)	10μF±10%	6.1	5.3	3.9	1.2±0.2mm
KRM55WR71J226MH01K	63Vdc	X7R (EIA)	22μF±20%	6.1	5.3	6.7	1.2±0.2mm
KRM31KR72A105KH01K	100Vdc	X7R (EIA)	1.0μF±10%	3.5	1.7	2.9	0.8±0.2mm
KRM31KR72A225KH01K	100Vdc	X7R (EIA)	2.2μF±10%	3.7	1.7	2.9	0.8±0.2mm
KRM55LR72A475KH01K	100Vdc	X7R (EIA)	4.7μF±10%	6.1	5.3	3	1.2±0.2mm
KRM55QR72A685KH01K	100Vdc	X7R (EIA)	6.8μF±10%	6.1	5.3	3.9	1.2±0.2mm
KRM55TR72A106MH01K	100Vdc	X7R (EIA)	10μF±20%	6.1	5.3	5	1.2±0.2mm
KRM55WR72A156MH01K	100Vdc	X7R (EIA)	15μF±20%	6.1	5.3	6.7	1.2±0.2mm

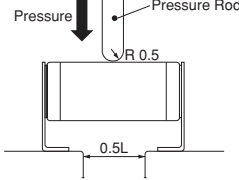
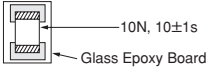

## KRM Series Specifications and Test Methods

No.	Item	Specifications	Test Method												
1	Operating Temperature Range	X5R Char.: -55 to +85°C X6S Char.: -55 to +105°C X7R Char.: -55 to +125°C	Reference temperature: 25°C												
2	Appearance	No defects or abnormalities	Visual inspection												
3	Dimensions	Within the specified dimensions	Using calipers and micrometers												
4	Dielectric Strength	No defects or abnormalities	<p>No failure should be observed when voltage in the table is applied between the terminations for 1 to 5 sec., provided the charge/discharge current is less than 50mA.</p> <table border="1" style="width: 100%; border-collapse: collapse; margin-top: 10px;"> <thead> <tr style="background-color: #f2f2f2;"> <th>Rated Voltage</th> <th>Test Voltage</th> </tr> </thead> <tbody> <tr> <td>DC25V, DC50V, DC63V</td> <td>250% of the rated voltage</td> </tr> <tr> <td>DC100V</td> <td>200% of the rated voltage</td> </tr> </tbody> </table>	Rated Voltage	Test Voltage	DC25V, DC50V, DC63V	250% of the rated voltage	DC100V	200% of the rated voltage						
Rated Voltage	Test Voltage														
DC25V, DC50V, DC63V	250% of the rated voltage														
DC100V	200% of the rated voltage														
5	Insulation Resistance (I.R.)	[KRM31] W.V.: 25V : More than 50MΩ · μF W.V.: 50V/100V : More than 500MΩ · μF [KRM55] More than 100MΩ · μF	The insulation resistance should be measured with Rated Voltage and within 60±5 sec. of charging.												
6	Capacitance	Within the specified tolerance	<p>The capacitance/D.F. should be measured at reference temperature at the meaning frequency and voltage shown in the table.</p> <table border="1" style="width: 100%; border-collapse: collapse; margin-top: 10px;"> <thead> <tr style="background-color: #f2f2f2;"> <th>Nominal Capacitance</th> <th>Measuring Frequency</th> <th>Measuring Voltage</th> </tr> </thead> <tbody> <tr> <td>C&gt;10μF</td> <td>120±24Hz</td> <td>AC0.5±0.1V(r.m.s.)</td> </tr> <tr> <td>C≤10μF</td> <td>1±0.2kHz</td> <td>AC1.0±0.2V(r.m.s.)</td> </tr> </tbody> </table>	Nominal Capacitance	Measuring Frequency	Measuring Voltage	C>10μF	120±24Hz	AC0.5±0.1V(r.m.s.)	C≤10μF	1±0.2kHz	AC1.0±0.2V(r.m.s.)			
Nominal Capacitance	Measuring Frequency	Measuring Voltage													
C>10μF	120±24Hz	AC0.5±0.1V(r.m.s.)													
C≤10μF	1±0.2kHz	AC1.0±0.2V(r.m.s.)													
7	Dissipation Factor (D.F.)	[KRM31] W.V.: 25V : 0.15 max. W.V.: 50V : 0.025 max. W.V.: 100V : 0.05 max. [KRM55] 0.025 max.													
8	Capacitance Temperature Characteristics	X5R Char.: Within ±15% (Temp. Range: -55 to +85°C) X6S Char.: Within ±22% (Temp. Range: -55 to +105°C) X7R Char.: Within ±15% (Temp. Range: -55 to +125°C)	<p>The capacitance measurement should be made at each step specified in the Table.</p> <table border="1" style="width: 100%; border-collapse: collapse; margin-top: 10px;"> <thead> <tr style="background-color: #f2f2f2;"> <th>Step</th> <th>Temperature (°C)</th> </tr> </thead> <tbody> <tr> <td>1</td> <td>25±2</td> </tr> <tr> <td>2</td> <td>Min. Operating Temp. ±3</td> </tr> <tr> <td>3</td> <td>25±2</td> </tr> <tr> <td>4</td> <td>Max. Operating Temp. ±2</td> </tr> <tr> <td>5</td> <td>25±2</td> </tr> </tbody> </table> <p>•Pretreatment                      Perform a heat treatment at 150+0/-10°C for 60±5 min. and then let sit for 24±2 hrs. at room condition. (*1)</p>	Step	Temperature (°C)	1	25±2	2	Min. Operating Temp. ±3	3	25±2	4	Max. Operating Temp. ±2	5	25±2
Step	Temperature (°C)														
1	25±2														
2	Min. Operating Temp. ±3														
3	25±2														
4	Max. Operating Temp. ±2														
5	25±2														
9	Strength of Metal Terminal	Termination not to be broken or loosened	<p>A static load of 10N using a pressure rod should be applied to the center in the direction of the arrow and held for 10 s.</p> 												
10	Adhesive Strength of Termination	No removal of the terminations or other defect should occur.	<p>Solder the capacitor to the testing jig (glass epoxy board) shown in Fig. 1.                      Then apply 10N force in the direction of the arrow.                      The soldering should be done using the reflow method and should be conducted with care so that the soldering is uniform and free defects such as heat shock.</p>  <p style="text-align: center;">Fig. 1</p>												

(\*1) "Room condition" Temperature: 15 to 35°C, Relative humidity: 45 to 75%, Atmospheric pressure: 86 to 106kPa

Continued on the following page.

For General Purpose KRM/KR3 Series

Product Information

# KRM Series Specifications and Test Methods

Continued from the preceding page.

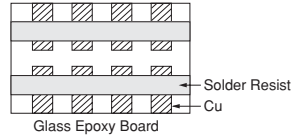
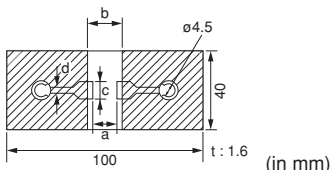
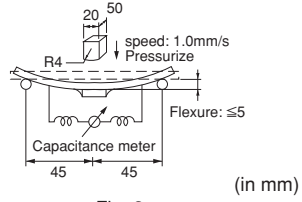
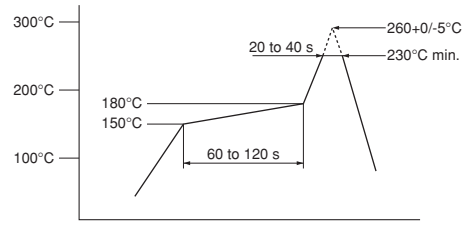
No.	Item	Specifications	Test Method																
11	Appearance	No defects or abnormalities	Solder the capacitor to the test jig (glass epoxy board). The capacitor should be subjected to a simple harmonic motion having a total amplitude of 1.5mm, the frequency being varied uniformly between the approximate limits of 10 and 55Hz. The frequency range, from 10 to 55Hz and return to 10Hz, should be traversed in approximately 1 min. This motion should be applied for a period of 2 hrs. in each of 3 mutually perpendicular directions (total of 6 hrs.).																
	Capacitance	Within the specified tolerance																	
11	Vibration Resistance	D.F. In accordance with item No.7																	
12	Deflection	No marking defects	Solder the capacitor to the testing jig (glass epoxy board) shown in Fig. 2. Then apply a force in the direction shown in Fig. 3. The soldering should be done using the reflow method and should be conducted with care so that the soldering is uniform and free of defects such as heat shock.																
		 <table border="1" data-bbox="367 884 877 985"> <thead> <tr> <th rowspan="2">Type</th> <th colspan="4">Dimension (mm)</th> </tr> <tr> <th>a</th> <th>b</th> <th>c</th> <th>d</th> </tr> </thead> <tbody> <tr> <td>KRM31</td> <td>2.2</td> <td>5.0</td> <td>1.65</td> <td>1.0</td> </tr> <tr> <td>KRM55</td> <td>4.5</td> <td>8.0</td> <td>5.6</td> <td>1.0</td> </tr> </tbody> </table>		Type	Dimension (mm)				a	b	c	d	KRM31	2.2	5.0	1.65	1.0	KRM55	4.5
Type	Dimension (mm)																		
	a	b	c	d															
KRM31	2.2	5.0	1.65	1.0															
KRM55	4.5	8.0	5.6	1.0															
12	Deflection																		
13	Solderability of Termination	The metal surface is soldered well	Reflow Soldering: Peak 260+0/-5°C The area of soldering 230°C min., 20 to 40 s Let sit for 24±2 h at room condition,* then measure. •Pretreatment Perform the heat treatment at 150+0/-10°C for 60±5 min. and then let sit for 24±2 h at room condition. (*1)																
																			
14	Appearance	No marking defects	•In case of Reflow Soldering See item 13 Solderability of termination •In case of Soldering Iron Temp. of solder: 350±10°C Solder time: 4+1/-0 s Let sit for 24±2 hrs.at room condition,* then measure Please refer to "Caution (Soldering and Mounting) Correction with a Soldering Iron"																
	Resistance to Soldering Heat	Capacitance Change		Within ±10%															
	D.F.	In accordance with item No.7																	
	I.R.	In accordance with item No.5																	
	Dielectric Strength	In accordance with item No.4																	

(\*1) "Room condition" Temperature: 15 to 35°C, Relative humidity: 45 to 75%, Atmospheric pressure: 86 to 106kPa

Continued on the following page. 

For General Purpose KRM/KR3 Series Product Information

## KRM Series Specifications and Test Methods

Continued from the preceding page.

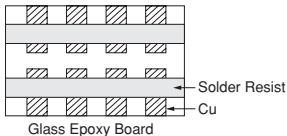
No.	Item	Specifications	Test Method															
15	Temperature Cycle	Appearance	No marking defects															
		Capacitance Change	Within $\pm 7.5\%$															
		D.F.	In accordance with item No.7															
		I.R.	In accordance with item No.5															
		Dielectric Strength	In accordance with item No.4															
			Fix the capacitor to the supporting jig (glass epoxy board) shown in Fig. 4. Perform the 100 cycles according to the 4 heat treatments listed in the following table. Let sit for 24 $\pm$ 2 hrs. at room condition,* then measure.															
			<table border="1" style="margin: auto;"> <thead> <tr> <th>Step</th> <th>Temperature (°C)</th> <th>Time (min.)</th> </tr> </thead> <tbody> <tr> <td>1</td> <td>Min. Operating Temp. <math>\pm 3</math></td> <td>30<math>\pm</math>3</td> </tr> <tr> <td>2</td> <td>Room Temp.</td> <td>2 to 3</td> </tr> <tr> <td>3</td> <td>Max. Operating Temp. <math>\pm 2</math></td> <td>30<math>\pm</math>3</td> </tr> <tr> <td>4</td> <td>Room Temp.</td> <td>2 to 3</td> </tr> </tbody> </table>	Step	Temperature (°C)	Time (min.)	1	Min. Operating Temp. $\pm 3$	30 $\pm$ 3	2	Room Temp.	2 to 3	3	Max. Operating Temp. $\pm 2$	30 $\pm$ 3	4	Room Temp.	2 to 3
Step	Temperature (°C)	Time (min.)																
1	Min. Operating Temp. $\pm 3$	30 $\pm$ 3																
2	Room Temp.	2 to 3																
3	Max. Operating Temp. $\pm 2$	30 $\pm$ 3																
4	Room Temp.	2 to 3																
			<p>•Pretreatment                      Perform a heat treatment at 150+0/-10°C for 60<math>\pm</math>5 min. and then let sit for 24<math>\pm</math>2 hrs. at room condition. (*1)</p>															
			 <p>Fig. 4</p>															
16	Humidity (Steady State)	Appearance	No marking defects															
		Capacitance Change	Within $\pm 15\%$															
		D.F.	[KRM31] W.V.: 25V : 0.2 max. W.V.: 50V/100V : 0.05 max. [KRM55] 0.05 max.															
		I.R.	[KRM31] W.V.: 25V : More than 12.5M $\Omega$ · $\mu$ F W.V.: 50V/100V : More than 50M $\Omega$ · $\mu$ F [KRM55] More than 10M $\Omega$ · $\mu$ F															
		Dielectric Strength	In accordance with item No.4															
			Let the capacitor sit at 40 $\pm$ 2°C and relative humidity of 90 to 95% for 500+24/-0 hrs. Remove and let sit for 24 $\pm$ 2 hrs. at room condition,* then measure.															
			<p>•Pretreatment                      Perform a heat treatment at 150+0/-10°C for 60<math>\pm</math>5 min. and then let sit for 24<math>\pm</math>2 hrs. at room condition. (*1)</p>															
17	Life	Appearance	No marking defects															
		Capacitance Change	Within $\pm 15\%$															
		D.F.	[KRM31] W.V.: 25V : 0.2 max. W.V.: 50V/100V : 0.05 max. [KRM55] 0.05 max.															
		I.R.	[KRM31] W.V.: 25V : More than 25M $\Omega$ · $\mu$ F W.V.: 50V/100V : More than 50M $\Omega$ · $\mu$ F [KRM55] More than 10M $\Omega$ · $\mu$ F															
		Dielectric Strength	In accordance with item No.4															
			Apply voltage as in the Table for 1000+48/-0 hrs. at maximum operating temperature $\pm 3^\circ\text{C}$ . Remove and let sit for 24 $\pm$ 2 hrs. at room condition, (*1) then measure.															
			<table border="1" style="margin: auto;"> <thead> <tr> <th>Rated Voltage</th> <th>Applied Voltage</th> </tr> </thead> <tbody> <tr> <td>DC25V, DC50V</td> <td>200% of the rated voltage (*2)</td> </tr> <tr> <td>DC63V, DC100V</td> <td>150% of the rated voltage</td> </tr> </tbody> </table>	Rated Voltage	Applied Voltage	DC25V, DC50V	200% of the rated voltage (*2)	DC63V, DC100V	150% of the rated voltage									
Rated Voltage	Applied Voltage																	
DC25V, DC50V	200% of the rated voltage (*2)																	
DC63V, DC100V	150% of the rated voltage																	
			The charge/discharge current is than 50mA. •Pretreatment Perform a heat treatment at 150+0/-10°C for 60 $\pm$ 5 min. and then let sit for 24 $\pm$ 2 hrs. at room condition. (*1)															
			(*2) KRM31KC81E106, KRM31FR61E106, KRM31KR71H225, KRM31KR71H475, KRM31KR72A105 : 150% of the rated voltage															

(\*1) "Room condition" Temperature: 15 to 35°C, Relative humidity: 45 to 75%, Atmospheric pressure: 86 to 106kPa

## Metal Terminal Monolithic Ceramic Capacitors

### Large Capacitance and High Allowable Ripple Current KR3 Series

**Anti-noise**

**Deflecting crack**

**Soldering crack**

#### ■ Features

1. The product has high reliability against heat and mechanical impact.
2. Stacking two capacitors reduces the mounting space and achieves a large capacitance.
3. The unique terminal structure greatly reduces noise from the ceramics on the board.
4. This series can provide higher capacitance value under DC-Bias condition, compare with previous X7R char.
5. Improve the performance of ripple-resistance compared with X7R char.

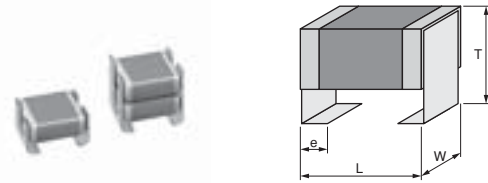

Part Number	Dimensions (mm)			
	L	W	T	e
KR355L	6.1±0.4	5.3±0.2	2.8±0.2	1.2±0.2
KR355Q			3.7±0.2	
KR355T			4.8±0.2	
KR355W			6.4±0.3	

#### ■ Applications

1. DC smoothing & EMI filter for LED Lighting.
2. For PFC circuit in the switching power supplies, AC adaptor.
3. DC-DC converter for general electronic equipment.

Do not use these products in any Automotive Power train or Safety equipment including Battery chargers for Electric Vehicles and Plug-in Hybrids. Only Murata products clearly stipulated as "for Automotive use" can be used for automobile applications such as Power train and Safety equipment.

Part Number	Rated Voltage	TC Code (Standard)	Capacitance	Length L (mm)	Width W (mm)	Thickness T max. (mm)	Metal Terminal Width e (mm)
KR355LD72E474KH01K	250Vdc	X7T (EIA)	0.47µF±10%	6.1	5.3	3	1.2±0.2mm
KR355QD72E105KH01K	250Vdc	X7T (EIA)	1.0µF±10%	6.1	5.3	3.9	1.2±0.2mm
KR355WD72E225MH01K	250Vdc	X7T (EIA)	2.2µF±20%	6.1	5.3	6.7	1.2±0.2mm
KR355LD72W224KH01K	450Vdc	X7T (EIA)	0.22µF±10%	6.1	5.3	3	1.2±0.2mm
KR355LD72W474KH01K	450Vdc	X7T (EIA)	0.47µF±10%	6.1	5.3	3	1.2±0.2mm
KR355QD72W564KH01K	450Vdc	X7T (EIA)	0.56µF±10%	6.1	5.3	3.9	1.2±0.2mm
KR355TD72W105MH01K	450Vdc	X7T (EIA)	1.0µF±20%	6.1	5.3	5	1.2±0.2mm
KR355WD72W125MH01K	450Vdc	X7T (EIA)	1.2µF±20%	6.1	5.3	6.7	1.2±0.2mm
KR355LD72J104KH01K	630Vdc	X7T (EIA)	0.1µF±10%	6.1	5.3	3	1.2±0.2mm
KR355LD72J154KH01K	630Vdc	X7T (EIA)	0.15µF±10%	6.1	5.3	3	1.2±0.2mm
KR355QD72J224KH01K	630Vdc	X7T (EIA)	0.22µF±10%	6.1	5.3	3.9	1.2±0.2mm
KR355QD72J274KH01K	630Vdc	X7T (EIA)	0.27µF±10%	6.1	5.3	3.9	1.2±0.2mm
KR355WD72J474MH01K	630Vdc	X7T (EIA)	0.47µF±20%	6.1	5.3	6.7	1.2±0.2mm
KR355WD72J564MH01K	630Vdc	X7T (EIA)	0.56µF±20%	6.1	5.3	6.7	1.2±0.2mm

## KR3 Series Specifications and Test Methods

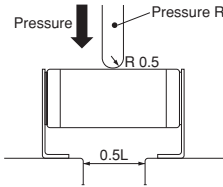
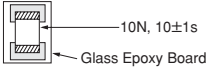
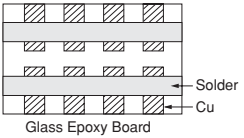
No.	Item	Specifications	Test Method												
1	Operating Temperature Range	-55 to +125°C	Reference temperature: 25°C												
2	Appearance	No defects or abnormalities	Visual inspection												
3	Dimensions	Within the specified dimensions	Using calipers and micrometers												
4	Dielectric Strength	No defects or abnormalities	<p>No failure should be observed when voltage in the table is applied between the terminations for 1 to 5 sec., provided the charge/discharge current is less than 50mA.</p> <table border="1" style="margin-left: auto; margin-right: auto;"> <thead> <tr style="background-color: #f2f2f2;"> <th>Rated Voltage</th> <th>Test Voltage</th> </tr> </thead> <tbody> <tr> <td>DC250V</td> <td>200% of the rated voltage</td> </tr> <tr> <td>DC450V</td> <td>150% of the rated voltage</td> </tr> <tr> <td>DC630V</td> <td>120% of the rated voltage</td> </tr> </tbody> </table>	Rated Voltage	Test Voltage	DC250V	200% of the rated voltage	DC450V	150% of the rated voltage	DC630V	120% of the rated voltage				
Rated Voltage	Test Voltage														
DC250V	200% of the rated voltage														
DC450V	150% of the rated voltage														
DC630V	120% of the rated voltage														
5	Insulation Resistance (I.R.)	More than 10,000MΩ or 100Ω · μF (Whichever is Smaller)	The insulation resistance should be measured with DC500V±50V (DC250V±25V in case of rated Voltage: DC250V, DC450V) and within 60±5 sec. of charging.												
6	Capacitance	Within the specified tolerance	The capacitance/D.F. should be measured at a frequency of 1±0.2kHz and a voltage of AC1±0.2V (r.m.s.).												
7	Dissipation Factor (D.F.)	0.01 max.													
8	Capacitance Temperature Characteristics	Cap. Change Within +22/-33% (Temp. Range: -55 to +125°C)	<p>The capacitance measurement should be made at each step specified in the table.</p> <table border="1" style="margin-left: auto; margin-right: auto;"> <thead> <tr style="background-color: #f2f2f2;"> <th>Step</th> <th>Temperature (°C)</th> </tr> </thead> <tbody> <tr> <td>1</td> <td>25±2</td> </tr> <tr> <td>2</td> <td>Min. Operating Temp. ±3</td> </tr> <tr> <td>3</td> <td>25±2</td> </tr> <tr> <td>4</td> <td>Max. Operating Temp. ±2</td> </tr> <tr> <td>5</td> <td>25±2</td> </tr> </tbody> </table> <p>•Pretreatment                      Perform a heat treatment at 150+0/-10°C for 60±5 min. and then let sit for 24±2 hrs. at room condition.*</p>	Step	Temperature (°C)	1	25±2	2	Min. Operating Temp. ±3	3	25±2	4	Max. Operating Temp. ±2	5	25±2
Step	Temperature (°C)														
1	25±2														
2	Min. Operating Temp. ±3														
3	25±2														
4	Max. Operating Temp. ±2														
5	25±2														
9	Strength of Metal Terminal	Termination not to be broken or loosened	<p>A static load of 10N using a pressure rod should be applied to the center in the direction of the arrow and held for 10 sec.</p> 												
10	Adhesive Strength of Termination	No removal of the terminations or other defect should occur.	<p>Solder the capacitor to the testing jig (glass epoxy board) shown in Fig. 1.                      Then apply 10N force in the direction of the arrow.                      The soldering should be done using the reflow method and should be conducted with care so that the soldering is uniform and free defects such as heat shock.</p>  <p style="text-align: center;">Fig. 1</p>												
11	Vibration Resistance	Appearance	No defects or abnormalities												
		Capacitance	Within the specified tolerance												
	D.F.	In accordance with item No.7	<p>Solder the capacitor to the test jig (glass epoxy board).                      The capacitor should be subjected to a simple harmonic motion having a total amplitude of 1.5mm, the frequency being varied uniformly between the approximate limits of 10 and 55Hz.                      The frequency range, from 10 to 55Hz and return to 10Hz, should be traversed in approximately 1 min. This motion should be applied for a period of 2 hrs. in each of 3 mutually perpendicular directions (total of 6 hrs.).</p> 												

\* "Room condition" Temperature: 15 to 35°C, Relative humidity: 45 to 75%, Atmospheric pressure: 86 to 106kPa

Continued on the following page.

For General Purpose KRM/KR3 Series

Product Information

## KR3 Series Specifications and Test Methods

Continued from the preceding page.

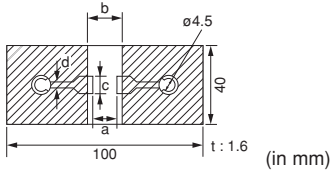
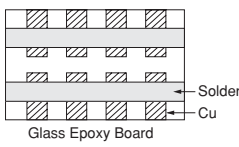
No.	Item	Specifications	Test Method															
12	Deflection	No marking defects	Solder the capacitor to the testing jig (glass epoxy board) shown in Fig. 2. Then apply a force in the direction shown in Fig. 3. The soldering should be done using the reflow method and should be conducted with care so that the soldering is uniform and free of defects such as heat shock.															
		 <table border="1" data-bbox="367 548 877 638"> <thead> <tr> <th>Type</th> <th colspan="4">Dimension (mm)</th> </tr> <tr> <th></th> <th>a</th> <th>b</th> <th>c</th> <th>d</th> </tr> </thead> <tbody> <tr> <td>KR355</td> <td>4.5</td> <td>8.0</td> <td>5.6</td> <td>1.0</td> </tr> </tbody> </table> <p style="text-align: center;">Fig. 2</p>		Type	Dimension (mm)					a	b	c	d	KR355	4.5	8.0	5.6	1.0
Type	Dimension (mm)																	
	a	b	c	d														
KR355	4.5	8.0	5.6	1.0														
13	Solderability of Termination	The metal surface is soldered well.	Reflow Soldering: Peak 260+0/-5°C The area of soldering 230°C min., 20 to 40 sec. Let sit for 24±2 hrs. at room condition*, then measure. <b>•Pretreatment</b> Perform the heat treatment at 150+0/-10°C for 60±5 min. and then let sit for 24±2 hrs. at room condition.*															
14	Resistance to Soldering Heat	Appearance	No marking defects															
		Capacitance Change	Within ±10%															
		D.F.	In accordance with item No.7															
		I.R.	In accordance with item No.5															
		Dielectric Strength	In accordance with item No.4															
15	Temperature Cycle	Appearance	No marking defects															
		Capacitance Change	Within ±7.5%															
		D.F.	In accordance with item No.7															
		I.R.	In accordance with item No.5															
		Dielectric Strength	In accordance with item No.4															
			•In case of Reflow Soldering See item 13 Solderability of Termination •In case of Soldering Iron Temp. of solder: 350±10°C Solder time: 4+1/-0 sec. Let sit for 24±2 hrs. at room condition,* then measure. Please refer to "Caution (Soldering and Mounting) Correction with a Soldering Iron".															
			Fix the capacitor to the supporting jig (glass epoxy board) shown in Fig. 4. Perform the 100 cycles according to the 4 heat treatments listed in the following table. Let sit for 24±2 hrs. at room condition*, then measure.															
			<table border="1" data-bbox="933 1433 1452 1556"> <thead> <tr> <th>Step</th> <th>Temperature (°C)</th> <th>Time (min.)</th> </tr> </thead> <tbody> <tr> <td>1</td> <td>Min. Operating Temp. ±3</td> <td>30±3</td> </tr> <tr> <td>2</td> <td>Room Temp.</td> <td>2 to 3</td> </tr> <tr> <td>3</td> <td>Min. Operating Temp. ±2</td> <td>30±3</td> </tr> <tr> <td>4</td> <td>Room Temp.</td> <td>2 to 3</td> </tr> </tbody> </table>	Step	Temperature (°C)	Time (min.)	1	Min. Operating Temp. ±3	30±3	2	Room Temp.	2 to 3	3	Min. Operating Temp. ±2	30±3	4	Room Temp.	2 to 3
Step	Temperature (°C)	Time (min.)																
1	Min. Operating Temp. ±3	30±3																
2	Room Temp.	2 to 3																
3	Min. Operating Temp. ±2	30±3																
4	Room Temp.	2 to 3																
			<b>•Pretreatment</b> Perform a heat treatment at 150+0/-10°C for 60±5 min. and then let sit for 24±2 hrs. at room condition.*															
			 <p style="text-align: center;">Fig. 4</p>															

\* "Room condition" Temperature: 15 to 35°C, Relative humidity: 45 to 75%, Atmospheric pressure: 86 to 106kPa

Continued on the following page. ↗



## KR3 Series Specifications and Test Methods

☐ Continued from the preceding page.

No.	Item	Specifications	Test Method								
16	Humidity (Steady State)	Appearance	No marking defects								
		Capacitance Change	Within $\pm 12.5\%$								
		D.F.	0.02 max.								
		I.R.	More than $1,000M\Omega$ or $10M\Omega \cdot \mu F$ (Whichever is smaller)								
		Dielectric Strength	In accordance with item No.4								
			Let the capacitor sit at $40\pm 2^{\circ}C$ and relative humidity of 90 to 95% for $500+24/-0$ hrs. Remove and let sit for $24\pm 2$ hrs. at room condition*, then measure. <b>•Pretreatment</b> Perform a heat treatment at $150+0/-10^{\circ}C$ for $60\pm 5$ min. and then let sit for $24\pm 2$ hrs. at room condition.*								
17	Life	Appearance	No marking defects								
		Capacitance Change	Within $\pm 12.5\%$								
		D.F.	0.02 max.								
		I.R.	More than $1,000M\Omega$ or $10M\Omega \cdot \mu F$ (Whichever is smaller)								
		Dielectric Strength	In accordance with item No.4								
			Apply voltage as in the Table for $1000+48/-0$ hrs. at maximum operating temperature $\pm 3^{\circ}C$ . Remove and let sit for $24\pm 2$ hrs. at room condition,* then measure. <table border="1" style="margin: 10px auto; border-collapse: collapse; text-align: center;"> <thead> <tr style="background-color: #f2f2f2;"> <th>Rated Voltage</th> <th>Applied Voltage</th> </tr> </thead> <tbody> <tr> <td>DC250V</td> <td>150% of the rated voltage</td> </tr> <tr> <td>DC450V</td> <td>130% of the rated voltage</td> </tr> <tr> <td>DC630V</td> <td>120% of the rated voltage</td> </tr> </tbody> </table> The charge/discharge current is than 50mA. <b>•Pretreatment</b> Apply test voltage for $60\pm 5$ min. at test temperature. Remove and let sit for $24\pm 2$ hrs, at room condition.*	Rated Voltage	Applied Voltage	DC250V	150% of the rated voltage	DC450V	130% of the rated voltage	DC630V	120% of the rated voltage
Rated Voltage	Applied Voltage										
DC250V	150% of the rated voltage										
DC450V	130% of the rated voltage										
DC630V	120% of the rated voltage										

\* "Room condition" Temperature: 15 to 35°C, Relative humidity: 45 to 75%, Atmospheric pressure: 86 to 106kPa

For General Purpose  
 KRM/KR3 Series

Product Information

# Package

Taping is standard packaging method.

## Minimum Quantity Guide

Part Number	Dimensions (mm)			Quantity (pcs.)
	L	W	T	ø330mm Reel
K□□31K	3.5	1.7	2.7	4,000
K□□31F	3.5	1.7	1.9	5,000
K□□55L	6.1	5.3	2.8	2,000
K□□55Q	6.1	5.3	3.7	1,000
K□□55T	6.1	5.3	4.8	1,000
K□□55W	6.1	5.3	6.4	500

ø180mm reel is also available.

## Tape Carrier Packaging

### (1) Appearance of Taping

#### Embossed Tape

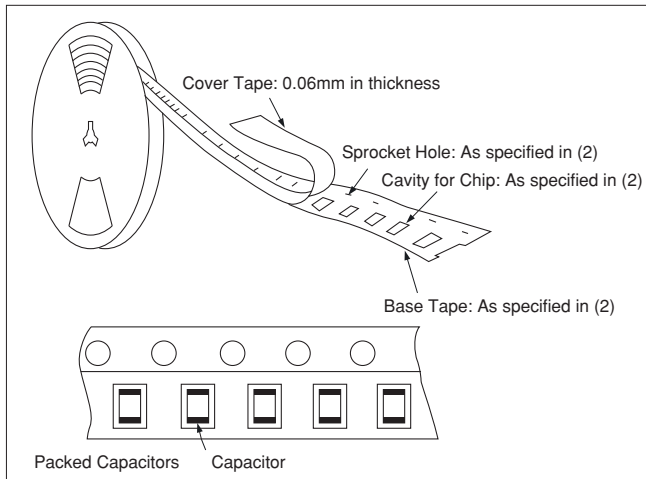

### (2) Dimensions of Tape

#### Embossed Tape

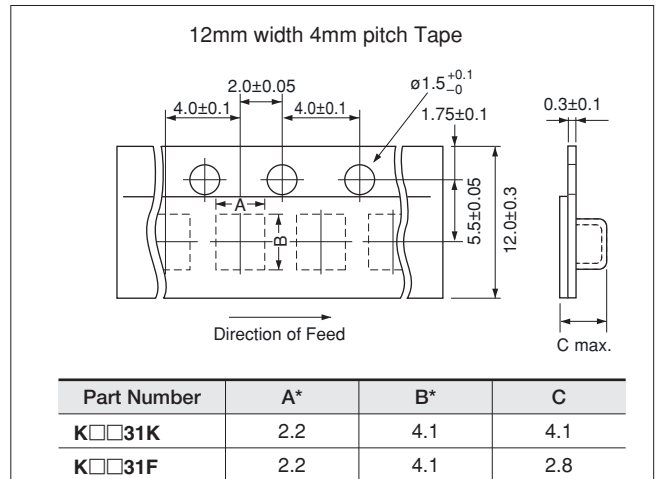

\*Nominal Value

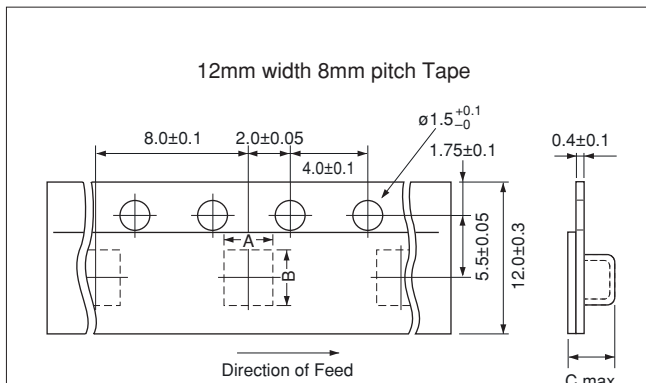

\*Nominal Value

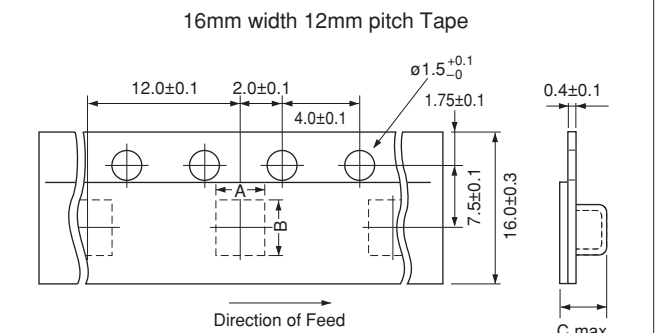

\*Nominal Value

(in mm)

Continued on the following page. ↗

## Package

☐ Continued from the preceding page.

### (3) Dimensions of Reel

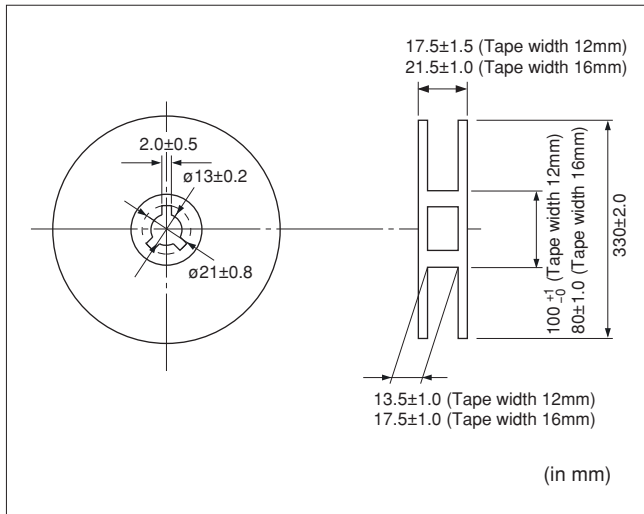

### (4) Taping Method

- ① Tapes for capacitors are wound clockwise. The sprocket holes are to the right as the tape is pulled toward the user.
- ② Part of the leader and part of the empty tape should be attached to the end of the tape as shown at right.
- ③ The top tape or cover tape and base tape are not attached at the end of the tape for a minimum of 5 pitches.
- ④ Missing capacitors number within 0.1% of the number per reel or 1 pc, whichever is greater, and are not continuous.
- ⑤ The top tape or cover tape and bottom tape should not protrude beyond the edges of the tape and should not cover sprocket holes.
- ⑥ Cumulative tolerance of sprocket holes, 10 pitches:  $\pm 0.3\text{mm}$ .
- ⑦ Peeling off force: 0.1 to 0.6N in the direction shown at right.

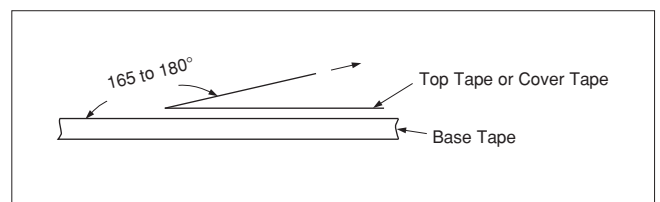
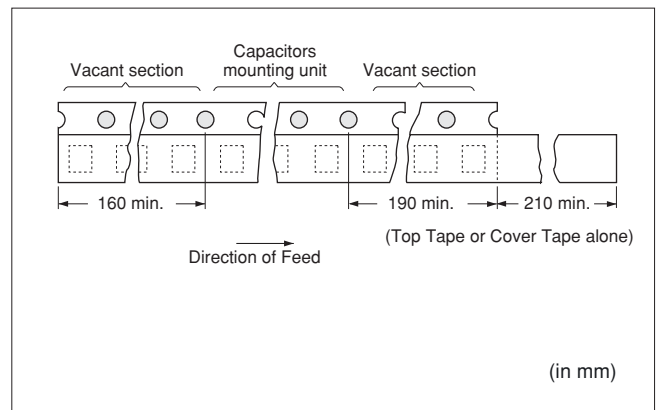

## ⚠Caution/Notice

### ⚠Caution

- Storage and Operation Conditions ..... 211
  
- Rating ..... 211
  - 1. Operating Voltage ..... 211
  - 2. Operating Temperature and Self-generated Heat ..... 211
  - 3. Fail-safe ..... 211
  
- Soldering and Mounting ..... 212
  - 1. Vibration and Impact ..... 212
  - 2. Land Layout for Cropping PC Board ..... 212
  - 3. Reflow Soldering ..... 212
  - 4. Flow Soldering ..... 213
  - 5. Correction with a Soldering Iron ..... 213

### Notice

- Rating ..... 214
  - 1. Capacitance Change of Capacitor ..... 214
  - 2. Performance Check by Equipment ..... 214
  
- Soldering and Mounting ..... 214
  - 1. Construction of Board Pattern ..... 214
  - 2. Mounting of Chips ..... 214
  - 3. Soldering ..... 214
  - 4. Cleaning ..... 214
  - 5. Resin Coating ..... 214

**⚠️Caution**

**■ Storage and Operation Conditions**

Do not use or store capacitors in a corrosive atmosphere, especially where chloride gas, sulfide gas, acid, alkali, salt or the like are present. In addition, avoid exposure to moisture. Before cleaning, bonding or molding this product, verify that these processes do not affect product quality by testing the

performance of a cleaned, bonded or molded product in the intended equipment. Store the capacitors where the temperature and relative humidity do not exceed 5 to 40 degrees centigrade and 20 to 70%. Use capacitors within 6 months of delivery. Check the solderability after 6 months or more.

**■ Rating**

**1. Operating Voltage**

When DC-rated capacitors are to be used in AC or ripple current circuits, be sure to maintain the  $V_{p-p}$  value of the applied voltage or the  $V_{o-p}$  which contains DC bias within the rated voltage range.

When the voltage is applied to the circuit, starting or stopping may generate irregular voltage for a transit period because of resonance or switching. Be sure to use a capacitor with a rated voltage range that includes these irregular voltages.

When DC-rated capacitors are to be used in input circuits from a commercial power source (AC filter), be sure to use Safety Certified Capacitors because various regulations for withstanding voltage or impulses, established for all equipment, should be taken into consideration.

Voltage	DC Voltage	DC+AC Voltage	AC Voltage	Pulse Voltage (1)	Pulse Voltage (2)
Positional Measurement					

**2. Operating Temperature and Self-generated Heat**

Keep the surface temperature of a capacitor below the upper limit of its rated operating temperature range. Be sure to take into account the heat generated by the capacitor itself. When the capacitor is used in a high-frequency voltage, pulse voltage, it may self-generate heat due to dielectric loss.

Applied voltage should be the load such as self-generated heat is within 20°C on the condition of atmosphere temperature 25°C. When measuring, use a thermocouple of small thermal capacity -K of  $\phi 0.1$ mm in conditions where the capacitor is not affected by radiant heat from other components or surrounding ambient fluctuations. Excessive heat may lead to deterioration of the capacitor's characteristics and reliability. (Never attempt to perform measurement with the cooling fan running. Otherwise, accurate measurement cannot be ensured.)

**3. Fail-safe**

Failure of a capacitor may result in a short circuit. Be sure to provide an appropriate fail-safe function such as a fuse on your product to help eliminate possible electric shock, fire, or fumes.

Continued on the following page.

For General Purpose  
 KRM/KF3 Series

Product Information  
 ⚠️Caution

## ⚠Caution

↳ Continued from the preceding page.

### ■ Soldering and Mounting

#### 1. Vibration and Impact

Do not expose a capacitor to excessive shock or vibration during use.

Do not directly touch the capacitor, especially the ceramic body. Residue from hands/fingers may create a short circuit environment.

#### 2. Land Layout for Cropping PC Board

Choose a mounting position that minimizes the stress imposed on the chip during flexing or bending of the board.

[Component Direction]

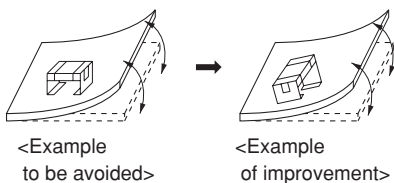

Locate chip horizontal to the direction in which stress acts.

[Chip Mounting Close to Board Separation Point]

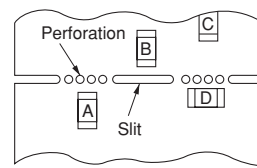

Chip arrangement Worst A>C>B~D Best

#### 3. Reflow Soldering

- When components are exposed to sudden heat, their mechanical strength can be decreased due to the extreme temperature changes which can cause flexing and result in internal mechanical damage, which will cause the parts to fail. In order to prevent mechanical damage, preheating is required for both the components and the PCB board. Preheating conditions are shown in Table 1. It is required to keep the temperature differential between the soldering and the components surface ( $\Delta T$ ) as small as possible.
- When components are immersed in solvent after mounting, be sure to maintain the temperature difference ( $\Delta T$ ) between the component and solvent within the range shown in the Table 1.

Table 1

Part Number	Temperature Differential
K□□31	$\Delta T \leq 190^\circ\text{C}$
K□□55	$\Delta T \leq 130^\circ\text{C}$

#### Recommended Conditions

	Pb-Sn Solder		Lead Free Solder
	Infrared Reflow	Vapor Reflow	
Peak Temperature	230-250°C	230-240°C	240-260°C
Atmosphere	Air	Air	Air or N <sub>2</sub>

Pb-Sn Solder: Sn-37Pb

Lead Free Solder: Sn-3.0Ag-0.5Cu

[Standard Conditions for Reflow Soldering]

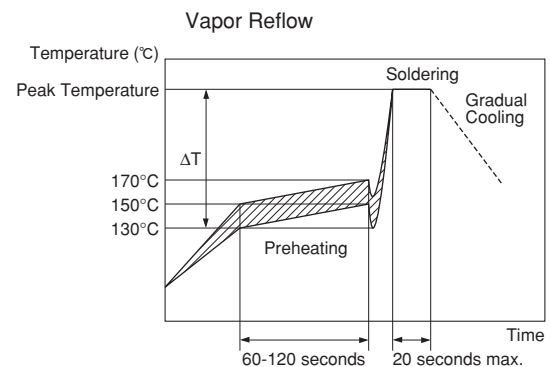
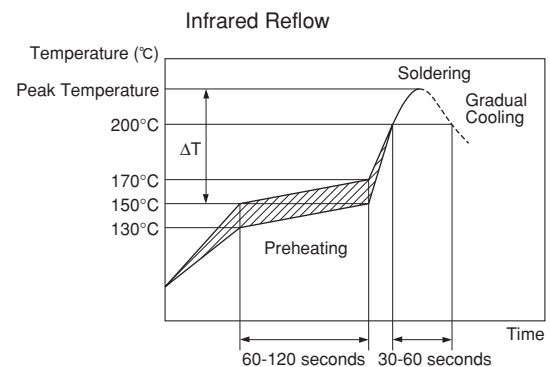

Continued on the following page. ↗



**⚠Caution**

☐ Continued from the preceding page.

**Optimum Solder Amount for Reflow Soldering**

- If solder paste is excessive, solder between a chip and a metal terminal melts. This causes the chip to move and come off.
- If solder paste is too little, it causes a lack of adhesive strength on the metal terminal and the capacitor comes off.
- Please make sure that solder is smoothly applied higher than 0.3mm and lower than the level of the bottom of the chip.

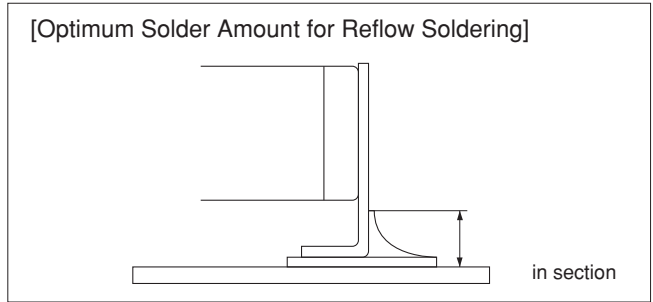

**Inverting the PCB**

Make sure not to impose an abnormal mechanical shock on the PCB.

**4. Flow Soldering**

Do not apply flow soldering.

**5. Correction with a Soldering Iron**

- Please refer to the figure of a soldering iron on the right.
- Please use thread solder which is smaller than 0.5mm in diameter.
- A soldering iron must be touched the bottom of metal terminal.
  - \*1) Do not touch ceramic, or it causes cracks because of sudden heat.
  - \*2) Do not touch the connection between a chip and a metal and the outside of that area, or it causes the chip to move and come off.

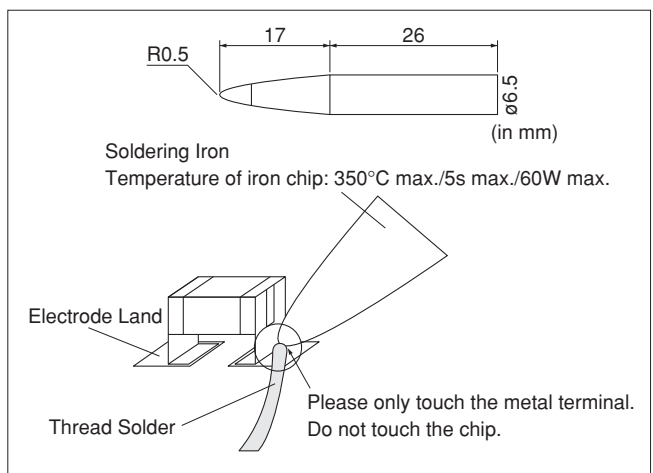

- Optimum Solder Amount when re-working Using a Solder Iron.

The top of the solder fillet should be lower than the level of the bottom of the chip.

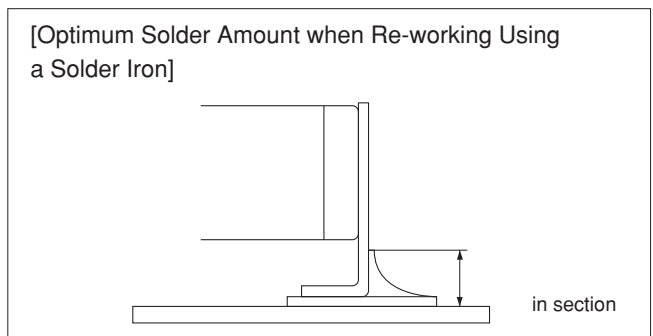

**FAILURE TO FOLLOW THE ABOVE CAUTIONS MAY RESULT, WORST CASE, IN A SHORT CIRCUIT AND CAUSE FUMING OR PARTIAL DISPERSION WHEN THE PRODUCT IS USED.**

For General Purpose KRM/KF3 Series

Product Information ⚠Caution

## Notice

### ■ Rating

#### 1. Capacitance Change of Capacitor

Capacitors have an aging characteristic, whereby the capacitor continually decreases its capacitance slightly if the capacitor is left on for a long time. Moreover, capacitance might change greatly depending on the surrounding temperature or an applied voltage. Therefore, it is not likely to be suitable for use in a time constant circuit.

Please contact us if you need detailed information.

#### 2. Performance Check by Equipment

Before using a capacitor, check that there is no problem in the equipment's performance and the specifications.

Generally speaking, CLASS 2 ceramic capacitors have voltage dependence characteristics and temperature dependence characteristics in capacitance. Therefore, the capacitance value may change depending on the operating condition in the equipment. Accordingly, be sure to confirm the apparatus performance of receiving influence in a capacitance value change of a capacitor, such as leakage current and noise suppression characteristics. Moreover, check the surge-proof ability of a capacitor in the equipment, if needed, because the surge voltage may exceed the specific value by the inductance of the circuit.

### ■ Soldering and Mounting

#### 1. Construction of Board Pattern

If solder is excessively applied to the circuit board, mechanical stress will cause destruction resistance characteristics to lower. To prevent this, be extremely careful in determining shape and dimension before designing the circuit board diagram.

#### Construction and Dimensions of Pattern (Example)

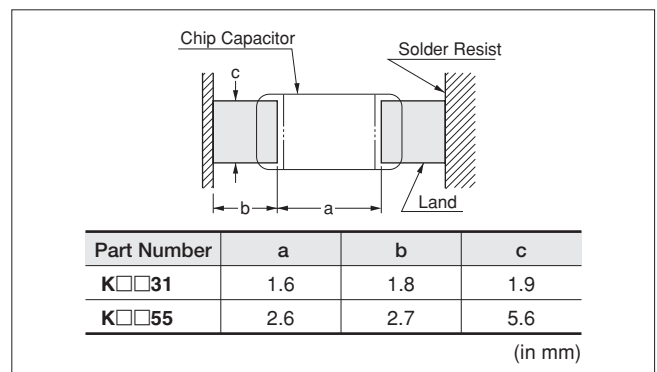

#### 2. Mounting of Chips

Mechanical shock of the chip placer

When the positioning claws and pick-up nozzle are worn, the load is applied to the chip while positioning is concentrated in one position, thus causing cracks, breakage, faulty positioning accuracy, etc.

Careful checking and maintenance are necessary to prevent unexpected trouble.

An excessively low bottom dead point of the suction nozzle imposes great force on the chip during mounting, causing cracked chips and the metal to bend. Please set the suction nozzle's bottom dead point on the upper surface of the board.

#### 3. Soldering

Flux Application

- Do not use strong acidic flux.
- Do not use water-soluble flux.\*

(\*Water-soluble flux can be defined as non rosin type flux including wash-type flux and non-wash-type flux.)

#### 4. Cleaning

Please confirm there is no problem in the reliability of the product beforehand when cleaning it with the intended equipment.

The residue after cleaning it might cause a decrease in the surface resistance of the chip and the corrosion of the electrode part, etc. As a result it might cause reliability to deteriorate. Please confirm beforehand that there is no problem with the intended equipment in ultrasonic cleansing.

#### 5. Resin Coating

Please use it after confirming there is no influence on the product with the intended equipment before the resin coating and molding.

A cracked chip might be caused at the cooling/heating cycle by the amount of resin spreading and/or bias thickness.

The resin for coating and molding must be selected as the stress is small when stiffening and the hygroscopic is low as possible.

## ISO 9001 Certifications

### ■ Qualified Standards

The products listed here have been produced by ISO 9001 certified factory.

Plant
Fukui Murata Mfg. Co., Ltd.
Izumo Murata Mfg. Co., Ltd.
Okayama Murata Mfg. Co., Ltd.
Murata Electronics Singapore (Pte.) Ltd.
Beijing Murata Electronics Co., Ltd.
Wuxi Murata Electronics Co., Ltd.

# Design assistant tool SimSurfing SimSurfing



## MLCC is now available !

Design assistant tool "SimSurfing" has been updated and you can now find and view any kind of characteristics of MLCCs.

### Available function for MLCCs.

- ① Products search
- ② View frequency characteristics (S parameters, Z, R, X, Q, DF, L, C)  
 DC bias can be applied to available part number.
- ③ DC voltage bias characteristics (Absolute capacitance/change rate)
- ④ Temperature characteristics (Absolute capacitance/change rate)
- ⑤ AC voltage bias characteristics (Absolute capacitance/change rate)
- ⑥ Download SPICE netlist/ S parameter

### 1 Select the Products

- (1) By part number
- (2) By specification

### 2 View characteristics

Clicking buttons in this area with partnumber selected, you can view any electrical characteristics chart.

### 3 Data download

You can download SPICE netlist and S parameter files (S2P)



These images are captured at September/2012. Be sure that this software will be updated frequently.

<http://ds.murata.com/software/simsurfing/en-us/mlcc/>

# EMICON-FUN!

Please check Murata's newsletter!  
 You can learn about electric parts with fun.  
[http://www.murata.com/products/emicon\\_fun/](http://www.murata.com/products/emicon_fun/)

EMICON-FUN! disseminated widely from basics (principles, characteristics, mounting, etc.) of capacitors, inductors and EMI suppression filters to information can practically be used.  
 Updated information is also distributed via the mail magazine.

You can register from the Products page on Murata Manufacturing Web site.  
<http://www.murata.com/products/>



← This banner is the entrance of register form

The screenshot displays the Murata Manufacturing Co., Ltd. website. The main content area is titled 'EMICON-FUN!' and describes it as an 'email Magazine: Have fun while learning about electronic components'. A featured article is 'Capacitor Room', which 'Introduce quick know-how, and inside story of capacitors'. A sidebar on the right promotes the 'Murata Newsletter' and lists various topics like Capacitor, EMI filters, noise countermeasures, inductors, magnetic field, noise, PLT(SH), alternating current, and AVN Car Navigation. A 'Recent articles' section lists several entries with dates and titles, such as 'Noise suppression filter Room' (Sep 14, 2012) and 'Capacitor Room' (Aug 28, 2012). An inset image shows a sample of the newsletter, which includes a table of contents for the October 28 issue, a welcome message, and an introduction to the 'EMICON-FUN!' magazine.



# Capacitor WEB Site Introduction

The WEB site and search engine of ceramic capacitors has been drastically renewed.

capacitor murata

<http://www.murata.com/products/capacitor/>

- ▶ **Convenient Search** | The type of searches has been increased to respond to various ways of searching.  
 The products you are searching for can easily be found from about 40,000 part numbers!  
 The frequency of revisions and discontinuance has been increased to provide the latest information at all times!
- ▶ **Substantial Technical Information** |
  - Reference drawings (Specifications and Test Methods) can be downloaded in PDF format.
  - Graphs of the electrical characteristic data (Capacitance - Temperature characteristics / DC bias characteristics / AC voltage characteristics / Frequency characteristics) can be displayed.
  - Reliability test data can be downloaded.



- 1 Search by features**  
 Products can be searched by problems, shapes or mounting methods.
- 2 Search in the lineups**  
 Products can be searched by entire product lineup.
- 3 Search by specifications**  
 Products can be searched by capacitance, rated voltage or temperature characteristics.
- 4 Cross reference search**  
 Equivalent products of Murata can be searched by competitors' part numbers.
- 5 Search by part number**  
 Products can be searched by Murata's part numbers.

**SimSurfing**

This is a WEB application to display characteristics charts of Murata products, and download the characteristics data.

- S parameter
- Netlist (SPICE Model)
- Data Libraries (for Agilent ADS, for AWR Microwave Office®)

**Frequently Asked Questions (FAQ)**

This is a collection of questions asked by customers. The contents of problems can easily be searched by keywords with this search function.

**Characteristics Data**

(Dimensions / Capacitance - Temperature Characteristics / DC Bias Characteristics / AC Voltage / Frequency Characteristics / Heat Generation by Ripple Currents, etc.)

**Reliability Test Data**

Initial Characteristics / Board Bending Resistance / Humidity Resistance / High Temperature Load / Solderability, etc.

**Safety Certificates by Series**

**List of ISO14001 Certified Plants**



⚠Note:

1. Export Control

<For customers outside Japan>

No Murata products should be used or sold, through any channels, for use in the design, development, production, utilization, maintenance or operation of, or otherwise contribution to (1) any weapons (Weapons of Mass Destruction [nuclear, chemical or biological weapons or missiles] or conventional weapons) or (2) goods or systems specially designed or intended for military end-use or utilization by military end-users.

<For customers in Japan>

For products which are controlled items subject to the "Foreign Exchange and Foreign Trade Law" of Japan, the export license specified by the law is required for export.

2. Please contact our sales representatives or product engineers before using the products in this catalog for the applications listed below, which require especially high reliability for the prevention of defects which might directly damage a third party's life, body or property, or when one of our products is intended for use in applications other than those specified in this catalog.

- |                             |  |
|-----------------------------|--|
| ① Aircraft equipment        | ② Aerospace equipment  |
| ③ Undersea equipment        | ④ Power plant equipment  |
| ⑤ Medical equipment         | ⑥ Transportation equipment (vehicles, trains, ships, etc.)   |
| ⑦ Traffic signal equipment  | ⑧ Disaster prevention / crime prevention equipment   |
| ⑨ Data-processing equipment | ⑩ Application of similar complexity and/or reliability requirements to the applications listed above |

3. Product specifications in this catalog are as of July 2012. They are subject to change or our products in it may be discontinued without advance notice. Please check with our sales representatives or product engineers before ordering. If there are any questions, please contact our sales representatives or product engineers.
4. Please read rating and ⚠CAUTION (for storage, operating, rating, soldering, mounting and handling) in this catalog to prevent smoking and/or burning, etc.
5. This catalog has only typical specifications. Therefore, please approve our product specifications or transact the approval sheet for product specifications before ordering.
6. Please note that unless otherwise specified, we shall assume no responsibility whatsoever for any conflict or dispute that may occur in connection with the effect of our and/or a third party's intellectual property rights and other related rights in consideration of your use of our products and/or information described or contained in our catalogs. In this connection, no representation shall be made to the effect that any third parties are authorized to use the rights mentioned above under licenses without our consent.
7. No ozone depleting substances (ODS) under the Montreal Protocol are used in our manufacturing process.