

FEATURES

- RoHS compliant
- 2.2μH to 880μH¹
- Up to 9.5A I_{DC}
- Bobbin format
- Dual winding
- Surface mount
- Integral EMI shield
- Compact size
- Tape and reel packaging
- No voltage breakdown at 500V_{DC}
- J-STD-020C reflow
- Backward compatible with Sn/Pb soldering systems

DESCRIPTION

The 4900 series is a range of dual wound inductors offering flexible options. Windings have a 1:1 ratio and can be connected in series or parallel to create a wide range of inductance combinations. The secondary winding could be used as a feedback winding in switched mode power supplies.

PIN CONNECTIONS (TOP VIEW)

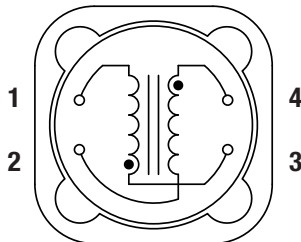

3 & 1 = Primary winding
4 & 2 = Secondary winding

Order Code	Inductance ¹ (10kHz, 100mV _{AC}) 1&3, 2&4	Inductance Range (10kHz, 100mV _{AC}) 1&3, 2&4	DC Current ² (parallel connection)	DC Resistance
	Nom.	Min. - Max.	Max.	Max.
	μH	μH	A	mΩ
492R2C	2.2	1.77 - 2.65	9.50	12.6
493R3C	3.3	2.47 - 3.70	7.80	14.9
494R7C	4.7	3.29 - 4.93	6.50	17.1
496R8C	6.8	5.27 - 7.91	5.40	27.0
49100C	10	7.70 - 11.6	4.50	41.0
49150C	15	10.6 - 16.0	3.70	53.0
49220C	22	15.9 - 23.8	3.00	81.0
49330C	33	24.5 - 36.8	2.50	128
49470C	47	35.1 - 52.6	2.10	191
49680C	68	50.8 - 76.2	1.71	233
49101C	100	73.6 - 110	1.41	343
49151C	150	111 - 166	1.15	529
49221C	220	167 - 251	0.95	805

MECHANICAL DIMENSIONS

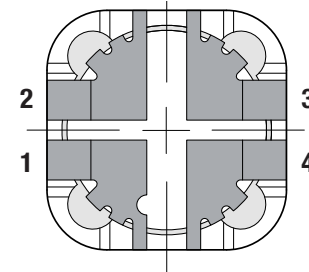
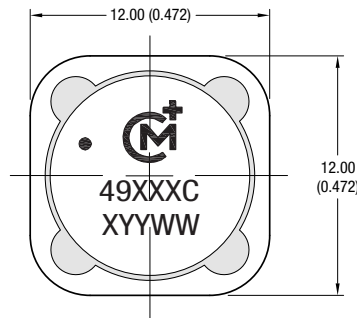

Recommended Footprint Details

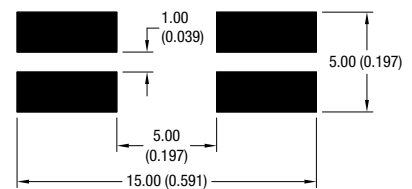

All dimensions in mm (inches). Package weight: 4g Typ.

ABSOLUTE MAXIMUM RATINGS

Isolation voltage (flash tested for 1 second), pins 3 & 4	500V _{DC}
Operating free air temperature range	-40°C to 85°C
Storage temperature range	-40°C to 125°C

SOLDERING INFORMATION³

Peak reflow temperature	245°C
Pin finish	Tin

Specifications typical at T_a = 25°C

- 1 When connecting windings in series, inductance will be 4 times the nominal figure shown.
- 2 If current is flowing in both windings, the maximum DC current occurs when either the inductance falls to 75% of its nominal value or when its temperature rise reaches 40°C, whichever is sooner.
- 3 For further information, please visit www.murata-ps.com/rohs



TAPE & REEL SPECIFICATIONS

REEL OUTLINE DIMENSIONS

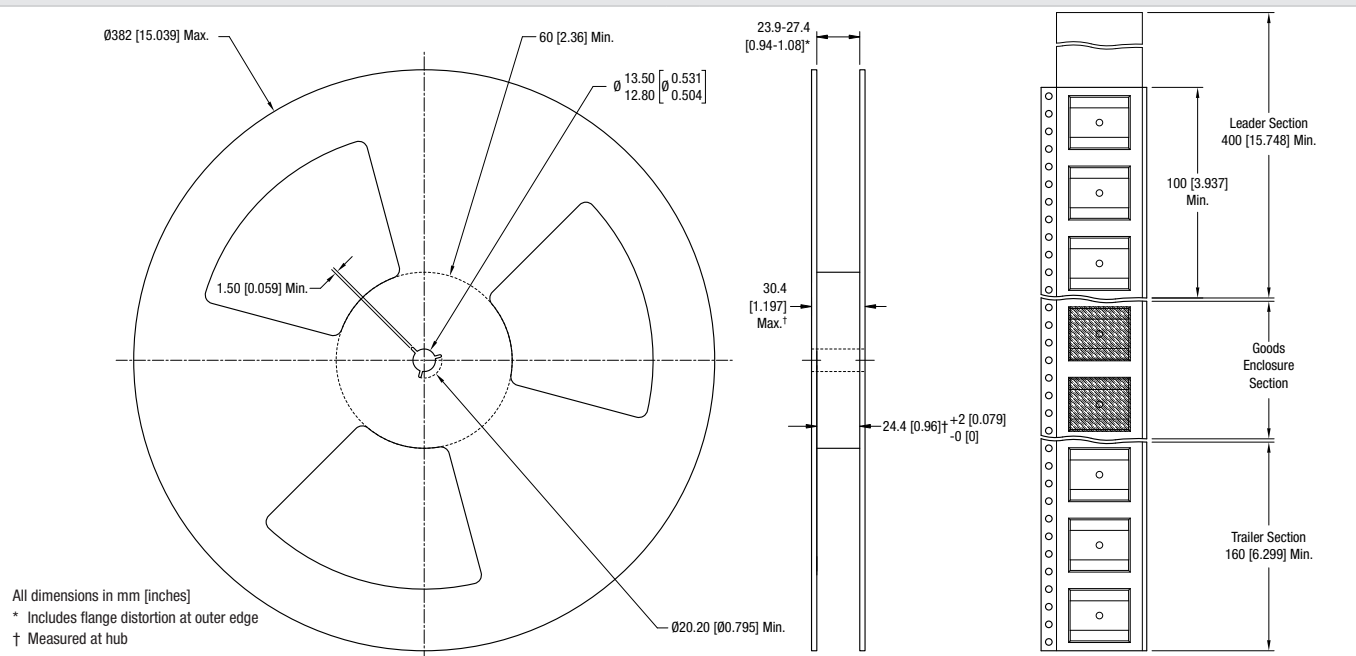

TAPE OUTLINE DIMENSIONS

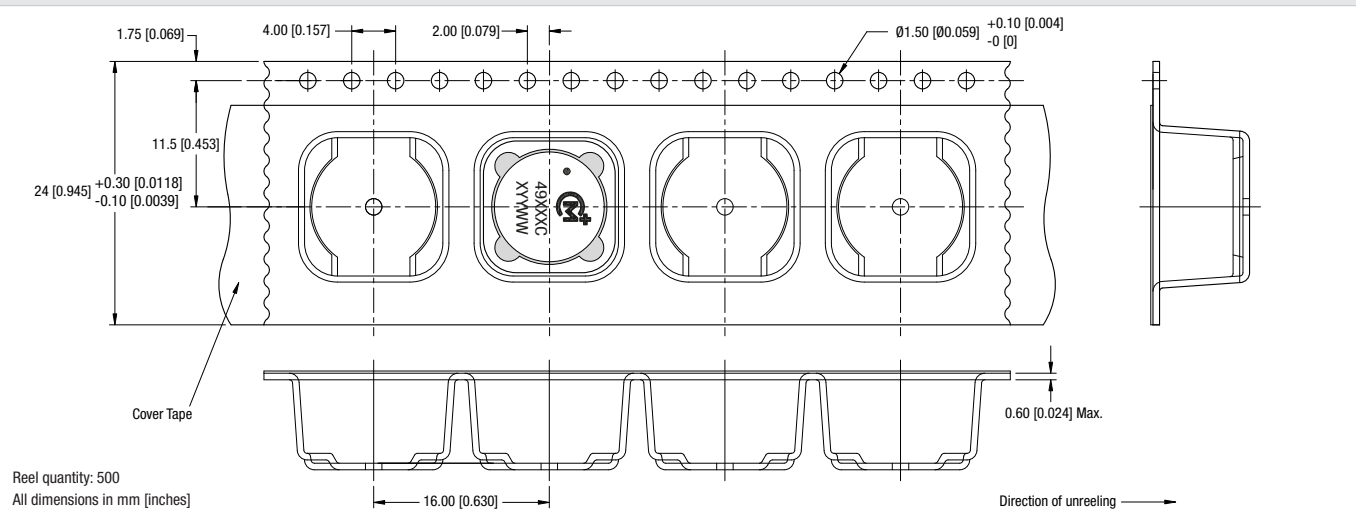

Murata Power Solutions, Inc.
 11 Cabot Boulevard, Mansfield, MA 02048-1151 U.S.A.
 ISO 9001 and 14001 REGISTERED

Murata Power Solutions, Inc. makes no representation that the use of its products in the circuits described herein, or the use of other technical information contained herein, will not infringe upon existing or future patent rights. The descriptions contained herein do not imply the granting of licenses to make, use, or sell equipment constructed in accordance therewith. Specifications are subject to change without notice.
 © 2017 Murata Power Solutions, Inc.