



### FEATURES

- RoHS compliant
- 0.28μH to 1.0mH
- Up to 8.7A I<sub>DC</sub>
- Bobbin format
- Surface mount
- Integral EMI shield
- Compact size
- Tape and reel packaging
- UL 94V-0 materials
- J-STD-020-C reflow

### DESCRIPTION

The 4600 series is a range of bobbin-wound, shielded inductors suitable for power-line filtering found in consumer electronics such as desktop computers, LED applications and GPS systems, as well as in a vast range of industrial and telecom applications including network hubs, bridges & routers, and high frequency wireless communication devices.

These surface mount inductors are extremely compact and have an integral shield, making them useful in EMI sensitive applications.

### PIN CONNECTIONS (TOP VIEW)

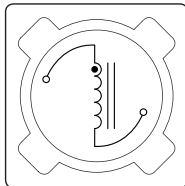

### SELECTION GUIDE

Order Code	Inductance (10kHz, 0.1VAC) ±20%	DC Current <sup>1</sup>		DC Resistance
	Nom.	Max.	Max.	Max.
	μH	A	mΩ	mΩ
46281C	0.28 (±30%)	8.7	8	
46541C	0.54 (±30%)	7.7	10	
46102C	1.0 (±30%)	6.8	13	
46152C	1.5 (±30%)	6.3	15	
46222C	2.2 (±30%)	5.0	21	
46332C	3.3 (±30%)	4.3	29	
46472C	4.7 (±30%)	3.7	37	
46682C	6.8 (±30%)	3.1	52	
46103C	10	2.4	66	
46153C	15	2.2	94	
46223C	22	1.8	120	
46333C	33	1.45	190	
46473C	47	1.25	260	
46683C	68	1.05	360	
46104C	100	0.86	500	
46154C	150	0.72	720	
46224C	220	0.57	1050	
46334C	330	0.46	1850	
46474C	470	0.39	2800	
46684C	680	0.32	3900	
46105C	1000	0.27	4900	

### MECHANICAL DIMENSIONS

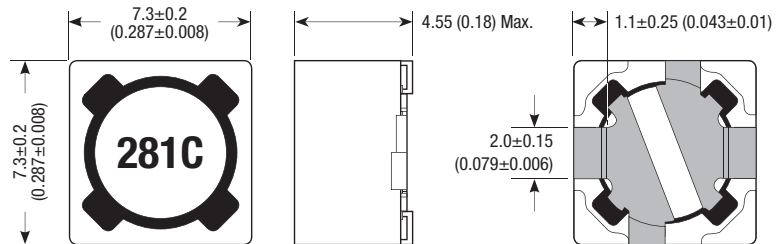

### Recommended Footprint Details\*

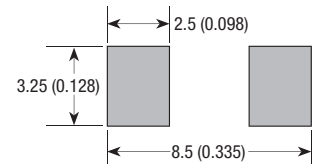

\*Distance between the outside ends of the terminations is 7.1±0.1 (0.28±0.004)  
 Unless otherwise stated, all dimensions in mm (inches) ± 0.25 (0.010).  
 Package weight: 0.8g Typ.

### ABSOLUTE MAXIMUM RATINGS

Operating temperature range	-40°C to 125°C
Storage temperature range	-40°C to 150°C

### SOLDERING INFORMATION<sup>2</sup>

Peak reflow solder temperature	250°C
Pin finish	Tin

Specifications typical at T<sub>A</sub> = 25°C

1 Maximum DC current occurs when either the inductance falls to 75% of its nominal value or when its temperature rise reaches 40°C, whichever is sooner.

2 For further information, please visit [www.murata-ps.com/rohs](http://www.murata-ps.com/rohs)



**INDUCTANCE Vs CURRENT**

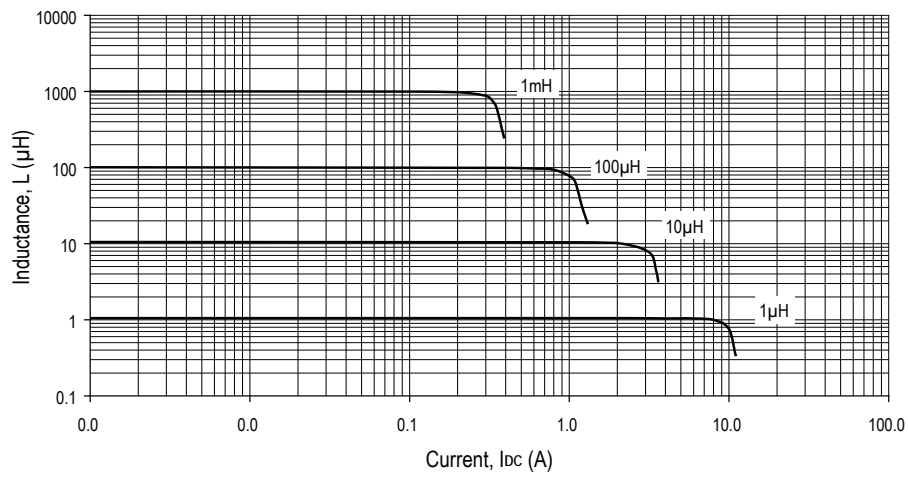

**TEMPERATURE Vs CURRENT**

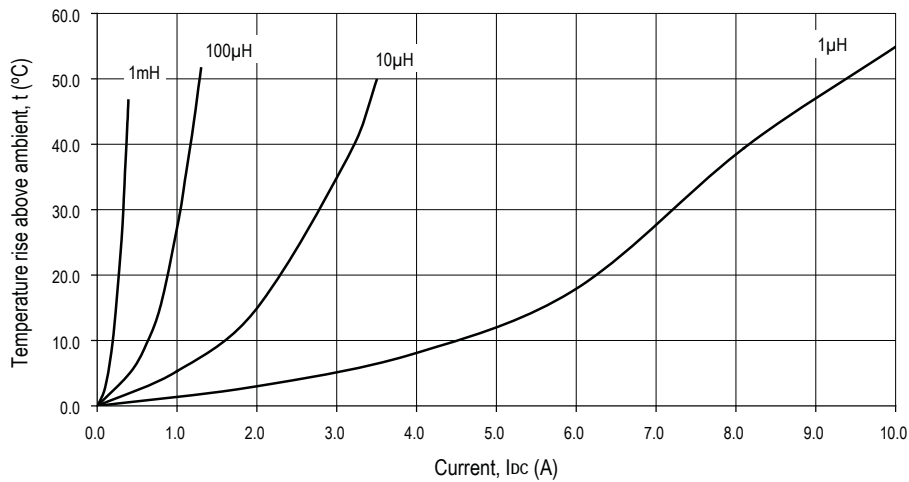

**INDUCTANCE Vs FREQUENCY**

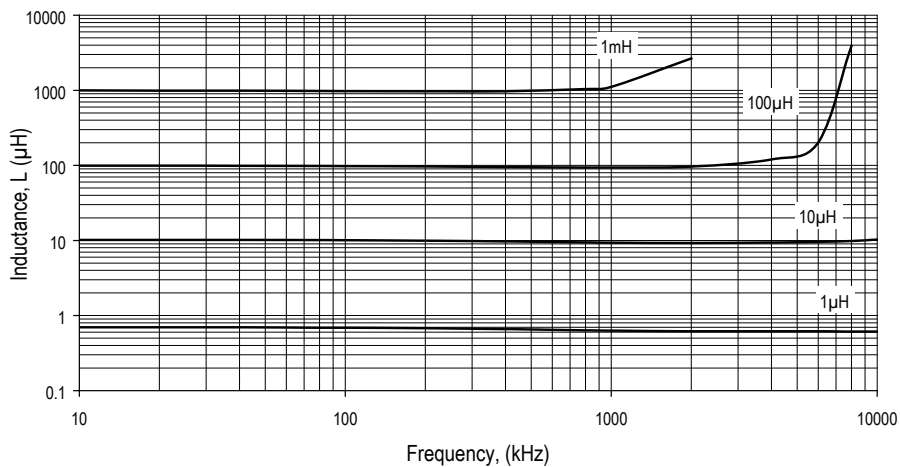

**TAPE & REEL SPECIFICATIONS**

**REEL OUTLINE DIMENSIONS**

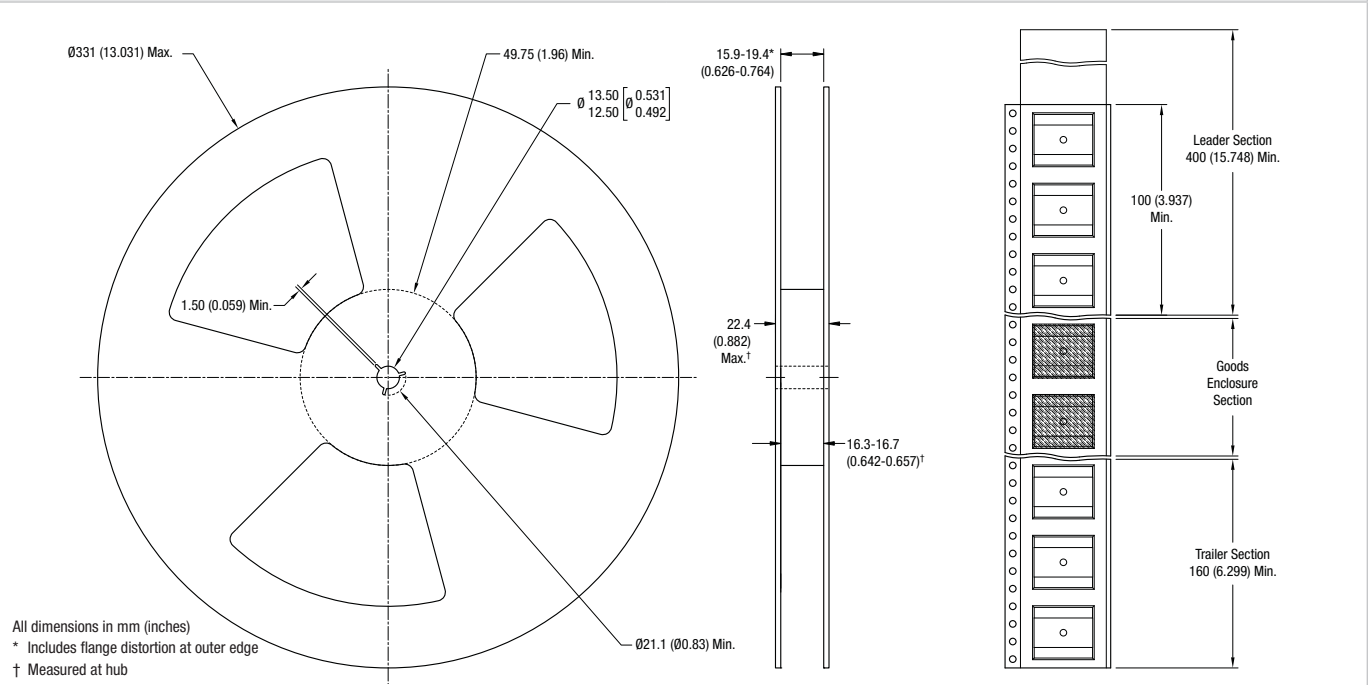

**TAPE OUTLINE DIMENSIONS**

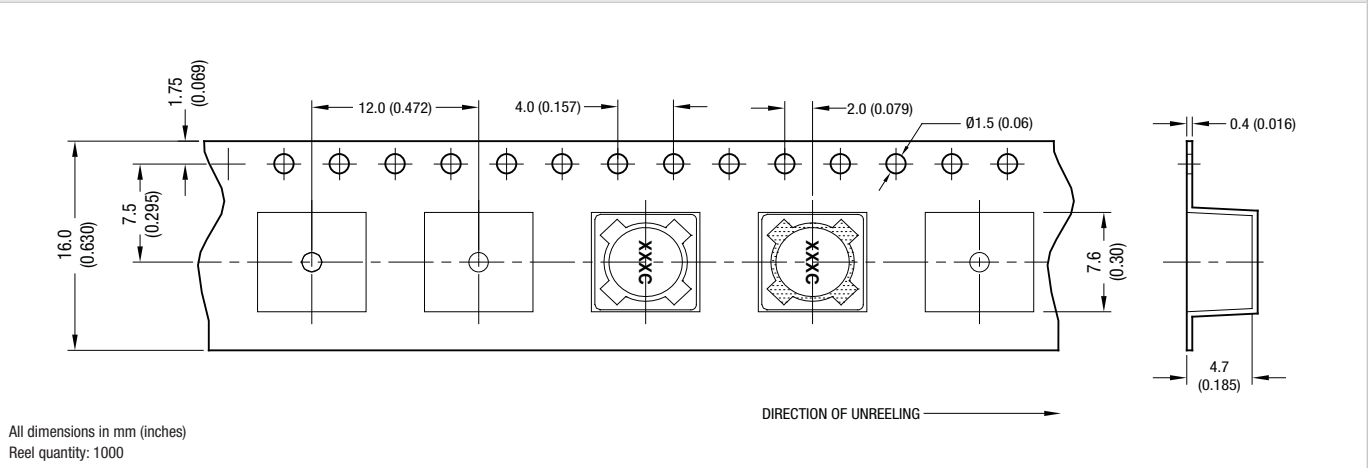

Murata Power Solutions, Inc.  
11 Cabot Boulevard, Mansfield, MA 02048-1151 U.S.A.  
ISO 9001 and 14001 REGISTERED

Murata Power Solutions, Inc. makes no representation that the use of its products in the circuits described herein, or the use of other technical information contained herein, will not infringe upon existing or future patent rights. The descriptions contained herein do not imply the granting of licenses to make, use, or sell equipment constructed in accordance therewith. Specifications are subject to change without notice.  
© 2011 Murata Power Solutions, Inc.