

FEATURES

- No opto feedback
- Patents Pending
- Optimised bipolar output voltages for IGBT/SiC & Mosfet gate drives
- Configurable dual outputs for all gate drive applications: +15V/-5V, +15V/-10V & +20V/-5V outputs
- Reinforced insulation to UL60950 recognized
- ANSI/AAMI ES60601-1 1MOPP/2MOOPs recognized
- Characterised dv/dt immunity 80kV/μs at 1.6kV
- Characterised partial discharge performance
- 5.2kVDC isolation test voltage 'Hi Pot Test'
- Ultra low coupling capacitance 15pF
- DC link voltage 3kVDC
- 5V, 12V & 24V input voltages
- 105°C operating temperature

PRODUCT OVERVIEW

Offering configurable dual output voltages of +15V/-10V, +20V/-5V and +15V/-5V, the MGJ6 series of DC-DC converters is ideal for powering 'high side' and 'low side' gate drive circuits for IGBTs, Silicon and Silicon Carbide Mosfets in bridge circuits. A choice of asymmetric output voltages allows optimum drive levels for best system efficiency and EMI. The MGJ6 series is characterised for high isolation and dv/dt requirements commonly seen in bridge circuits used in motor drives and inverters. A disable/frequency synchronisation pin simplifies EMC filter design. The MGJ6 protection features include short circuit protection and overload protection.



SELECTION GUIDE								
Order Code ¹	Input Voltage Range	Typical Application	Output 1			Output 2		
			Rated Output Voltage	Rated Output Current	Output Power	Rated Output Voltage	Rated Output Current	Output Power
			V	mA	W	V	mA	W
MGJ6T05150505MC	4.5 - 9	IGBT	+15	240	3.6	-10	240	2.4
MGJ6T12150505MC	9 - 18	IGBT	+15	240	3.6	-10	240	2.4
MGJ6T24150505MC	18 - 36	IGBT	+15	240	3.6	-10	240	2.4
MGJ6T05150505MC	4.5 - 9	SiC	+20	240	4.8	-5	240	1.2
MGJ6T12150505MC	9 - 18	SiC	+20	240	4.8	-5	240	1.2
MGJ6T24150505MC	18 - 36	SiC	+20	240	4.8	-5	240	1.2
MGJ6T05150505MC	4.5 - 9	MOSFET	+15	300	4.5	-5	300	1.5
MGJ6T12150505MC	9 - 18	MOSFET	+15	300	4.5	-5	300	1.5
MGJ6T24150505MC	18 - 36	MOSFET	+15	300	4.5	-5	300	1.5

SELECTION GUIDE (Continued)

Order Code ¹	Input Voltage Range	Typical Application	Output 1				Output 2			
			Load Regulation (Typ) ³	Load Regulation (Max) ³	Ripple & Noise (Typ) ²	Ripple & Noise (Max) ²	Load Regulation (Typ) ³	Load Regulation (Max) ³	Ripple & Noise (Typ) ²	Ripple & Noise (Max) ²
			%	%	mVp-p	mVp-p	%	%	mVp-p	mVp-p
MGJ6T05150505MC	4.5 - 9	IGBT	5	10	120	200	5	10	118	150
MGJ6T12150505MC	9 - 18	IGBT	5	10	148	200	5	10	116	150
MGJ6T24150505MC	18 - 36	IGBT	5	10	148	200	5	10	110	150
MGJ6T05150505MC	4.5 - 9	SiC	5	10	169	275	5	10	59	75
MGJ6T12150505MC	9 - 18	SiC	5	10	206	275	5	10	58	75
MGJ6T24150505MC	18 - 36	SiC	5	10	203	275	5	10	55	75
MGJ6T05150505MC	4.5 - 9	MOSFET	5	10	120	200	5	10	59	75
MGJ6T12150505MC	9 - 18	MOSFET	5	10	148	200	5	10	58	75
MGJ6T24150505MC	18 - 36	MOSFET	5	10	148	200	5	10	55	75

1. Components are supplied in tape and reel packaging, please refer to package specification section. Orderable part numbers are MGJ6T05150505MC-R7 (23 pieces per reel), or MGJ6T05150505MC-R13 (92 pieces per reel).

2. See ripple & noise test method.

3. Between 75% and 100% rated output current.

All specifications typical at T_A=25°C, nominal input voltage and rated output current unless otherwise specified.

SELECTION GUIDE (Continued)

Order Code	Nominal Input Voltage	Input Current at Rated Load	Efficiency (Min)	Efficiency (Typ)	Isolation Capacitance	MTTF ¹	
						MIL 217	Telecordia
						kHrs	
	V	mA	%		pF		
MGJ6T05150505MC	5	1500	72	78	15	552	6821
MGJ6T12150505MC	12	600	77	81	15	633	7061
MGJ6T24150505MC	24	300	79	83	15	666	6774

INPUT CHARACTERISTICS

Parameter	Conditions	Min.	Typ.	Max.	Units
Voltage range	5V input types	4.5	5	9	V
	12V input types	9	12	18	
	24V input types	18	24	36	
Under voltage lock out	Turn on threshold MGJ6T05		4.1		V
	Turn off threshold MGJ6T05		3.0		
	Turn on threshold MGJ6T12		8.1		
	Turn off threshold MGJ6T12		7.5		
	Turn on threshold MGJ6T24		16.7		
	Turn off threshold MGJ6T24		16.3		
Input ripple current	5V input types		40		mA p-p
	12V input types		40		
	24V input types		24		

OUTPUT CHARACTERISTICS

Parameter	Conditions	Min.	Typ.	Max.	Units
Minimum load	Below 10% load, 5V and 15V outputs are clamped to 6V and 16V respectively	10			%
Voltage set point accuracy	All output types		±4		%
Line regulation	Low line to high line			2	%
Transient response	Peak deviation (50-100% & 100-50% load swing)		0.4		%V _{out}
	Settling time		0.1		ms

ISOLATION CHARACTERISTICS

Parameter	Conditions	Min.	Typ.	Max.	Units
Isolation test voltage	Flash tested for 1 second	5200			VDC
	Qualification tested for 1 minute	5200			
Resistance	Viso = 1kVDC	100			GΩ
Continuous barrier withstand voltage	Non-safety barrier application			3000	V

GENERAL CHARACTERISTICS

Parameter	Conditions	Min.	Typ.	Max.	Units
Switching frequency			100		kHz

TEMPERATURE CHARACTERISTICS

Parameter	Conditions	Min.	Typ.	Max.	Units
Operation	See derating graphs	-40		105	°C
Storage		-50		125	
Product temperature rise above ambient	100% Load, Nom V _{in} , Still Air		25		

ABSOLUTE MAXIMUM RATINGS

Short-circuit protection	Continuous
Input voltage, MGJ6 5V input types	12V
Input voltage, MGJ6 12V input types	20V
Input voltage, MGJ6 24V input types	40V

1. Calculated using MIL-HDBK-217 FN2 and Telecordia SR-332 calculation model at T_A=25°C with nominal input voltage at full load.

APPLICATION NOTES

Start-up times

Typical start up times for this series, with no additional output capacitance are:

Part No.	Start-up times
	ms
MGJ6T05150505MC	15
MGJ6T12150505MC	15
MGJ6T24150505MC	15

Output capacitance must not exceed:

Output Voltage	Maximum output capacitance
V	µF
15	220
5	470

Disable/Frequency synchronisation

Please refer to application notes for further information.

		Min	Typ	Max	Units
Disable/Synch ¹	Pull Down Current		0.5		mA
	Input High	2		5	V
	Input Low	0		0.8	V
Synchronisation	Frequency Range	90	100	110	kHz
	Duty Cycle	25		75	%

1. Disable/Synch pin is active low.

Output configurations for power switches

Terminal	IGBT	SIC	MOSFET
(P6) 15V Output	+15V 0.24A	+20V 0.24A	+15V 0.3A
(P5) 15V Return 5VA Output	0V	No connection	0V
(P4) 5VA Return 5VB Output	No connection	0V	-5V 0.3A
(P3) 5VB Return	-10V 0.24A	-5V 0.24A	No connection

APPLICATION NOTES (Continued)

Schematic for driving IGBT, SiC & MOSFET

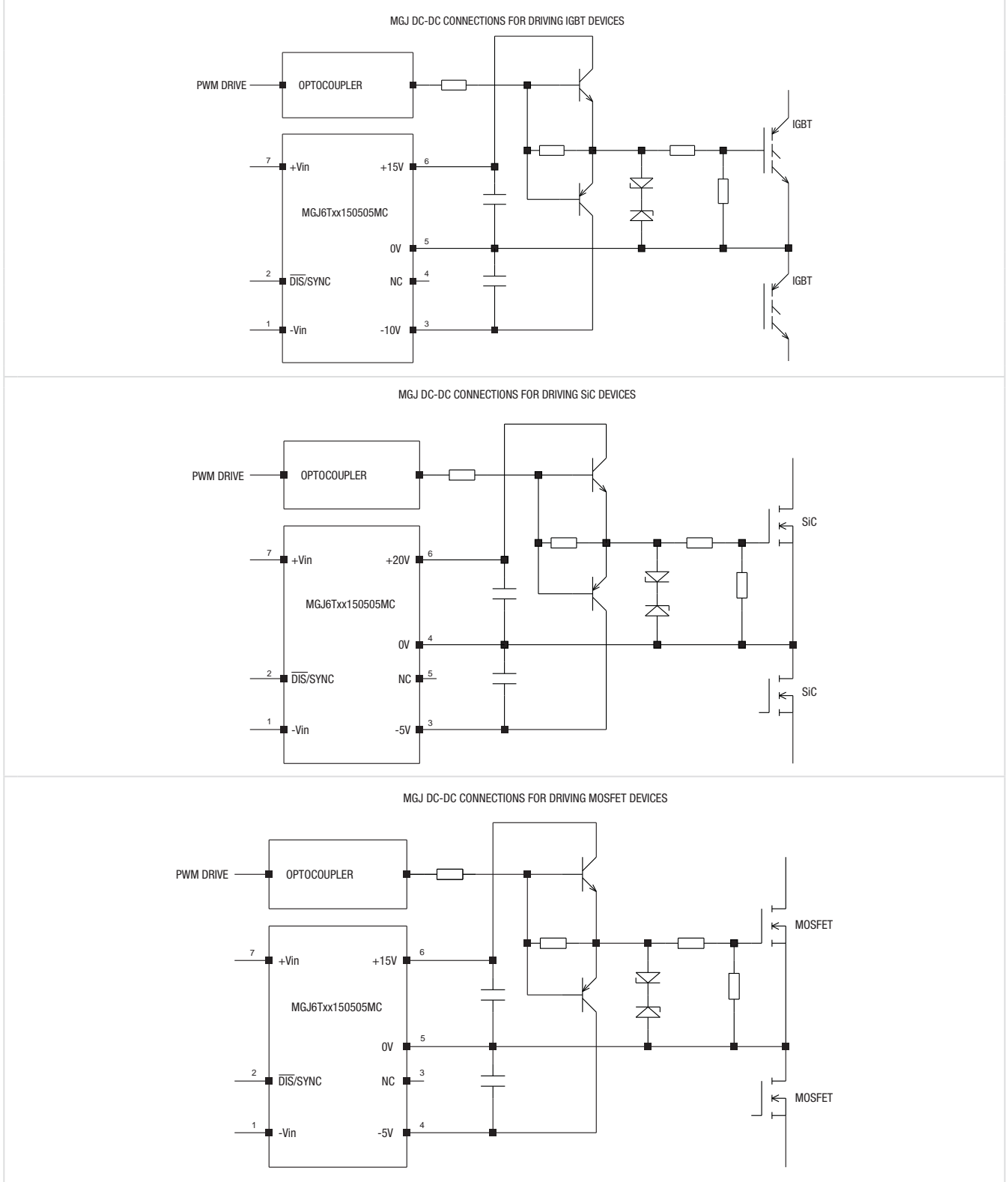

TECHNICAL NOTES

ISOLATION VOLTAGE

'Hi Pot Test', 'Flash Tested', 'Withstand Voltage', 'Proof Voltage', 'Dielectric Withstand Voltage' & 'Isolation Test Voltage' are all terms that relate to the same thing, a test voltage, applied for a specified time, across a component designed to provide electrical isolation, to verify the integrity of that isolation.

Murata Power Solutions MGJ6 series of DC/DC converters are all 100% production tested at 5.2kVDC for 1 second and qualification tested at 5.2kVDC for 1 minute.

A question commonly asked is, "What is the continuous voltage that can be applied across the part in normal operation?"

When the insulation in the MGJ6 series is not used as a safety barrier, i.e. provides functional isolation only, continuous or switched voltages across the barrier up to 3kV are sustainable. Long term reliability testing at these voltages continues. Peak Inception voltages measured were in excess of 3.5kV when testing for partial discharge in accordance with IEC 60270. Please contact Murata for further information.

The MGJ6 series has been recognized by Underwriters Laboratory to 250 Vrms Reinforced Insulation, please see safety approval section below.

REPEATED HIGH-VOLTAGE ISOLATION TESTING

It is well known that repeated high-voltage isolation testing of a barrier component can actually degrade isolation capability, to a lesser or greater degree depending on materials, construction and environment. We therefore strongly advise against repeated high voltage isolation testing, but if it is absolutely required, that the voltage be reduced by 20% from specified test voltage.

SAFETY APPROVAL

ANSI/AAMI ES60601-1

The MGJ6 series is recognized to ANSI/AAMI ES60601-1 and provides 1 MOPP (Means Of Patient Protection) and 2 MOOP (Means Of Operator Protection) based upon a working voltage of 250 Vrms max, between Primary and Secondary.

UL 60950

The MGJ6 series has been recognized by Underwriters Laboratory (UL) to UL 60950 for reinforced insulation to a working voltage of 250Vrms with a maximum measured product operating temperature of 105°C.

Creepage and clearance 7mm.

FUSING

The MGJ6 Series of converters are not internally fused so to meet the requirements of UL an anti-surge input line fuse should always be used with ratings as defined below.

Input Voltage, 5V 4A

Input Voltage, 12V 2A

Input Voltage, 24V 1A

All fuses should be UL recognized, 125V rated.

CHARACTERISATION TEST METHODS

Ripple & Noise Characterisation Method

Ripple and noise measurements are performed with the following test configuration.

C1	1µF X7R multilayer ceramic capacitor, voltage rating to be a minimum of 3 times the output voltage of the DC/DC converter
C2	10µF tantalum capacitor, voltage rating to be a minimum of 1.5 times the output voltage of the DC/DC converter with an ESR of less than 100mΩ at 100 kHz
C3	100nF multilayer ceramic capacitor, general purpose
R1	450Ω resistor, carbon film, ±1% tolerance
R2	50Ω BNC termination
T1	3T of the coax cable through a ferrite toroid
RLOAD	Resistive load to the maximum power rating of the DC/DC converter. Connections should be made via twisted wires

Measured values are multiplied by 10 to obtain the specified values.

Differential Mode Noise Test Schematic

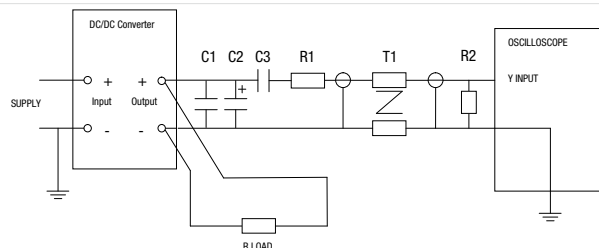

RoHS COMPLIANCE, MSL AND PSL INFORMATION



This series is compatible with RoHS soldering systems with a peak reflow solder temperature of 245°C and Time Above Liquidus for 90 seconds, as per J-STD-020D.1. The pin termination finish on this product series is Gold with Nickel Pre-plate. The series is backward compatible with Sn/Pb soldering systems. The series has a Moisture Sensitivity Level (MSL) 1. Samples of the product series were tested in accordance with the conditioning described for MSL level 1 in IPS/J-STD-020D.1. The product series passed electrical tests, co-planarity and visual inspection criteria.

EFFICIENCY VS LOAD

MGJ6T05150505MC

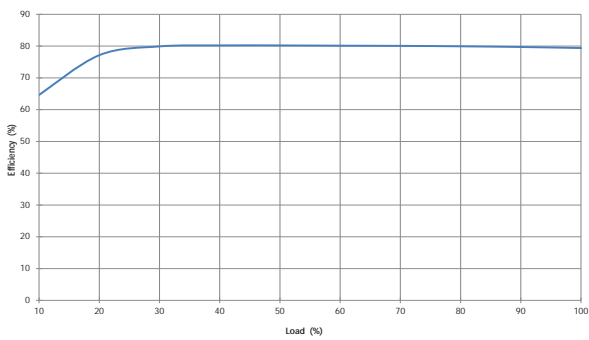

MGJ6T12150505MC

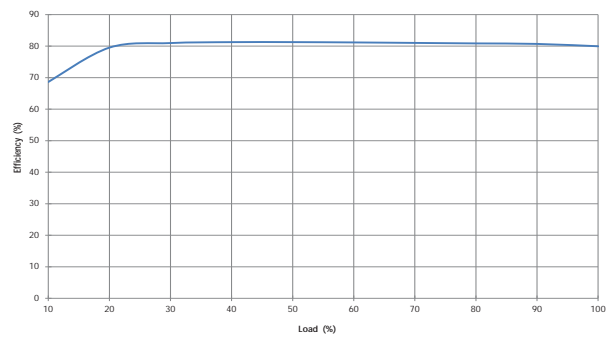

MGJ6T24150505MC

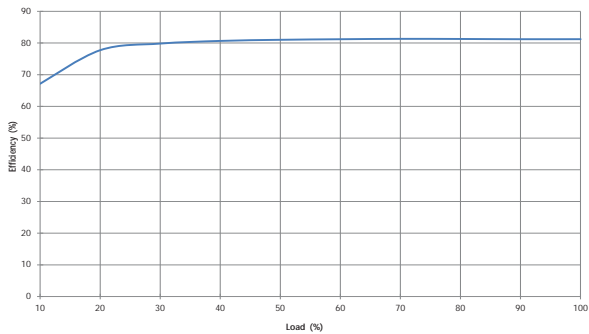

DERATING GRAPHS

Derating curves are based on IPC-9592. With no derating some components may be operating at the manufacturers maximum temperature ratings.

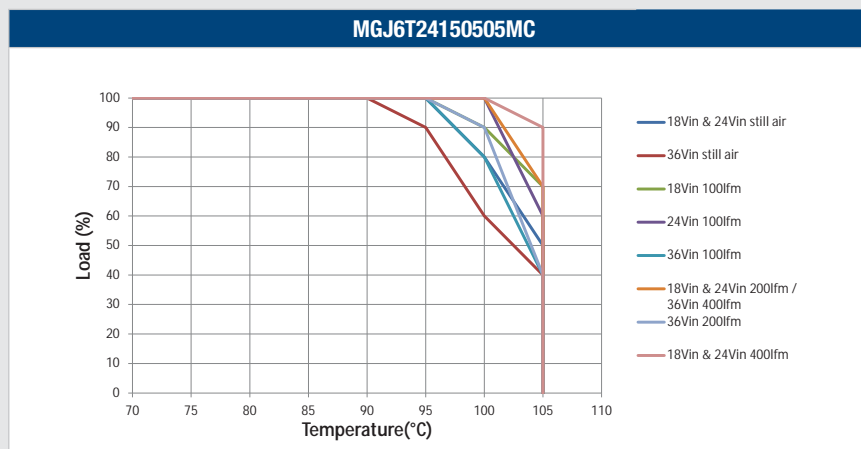
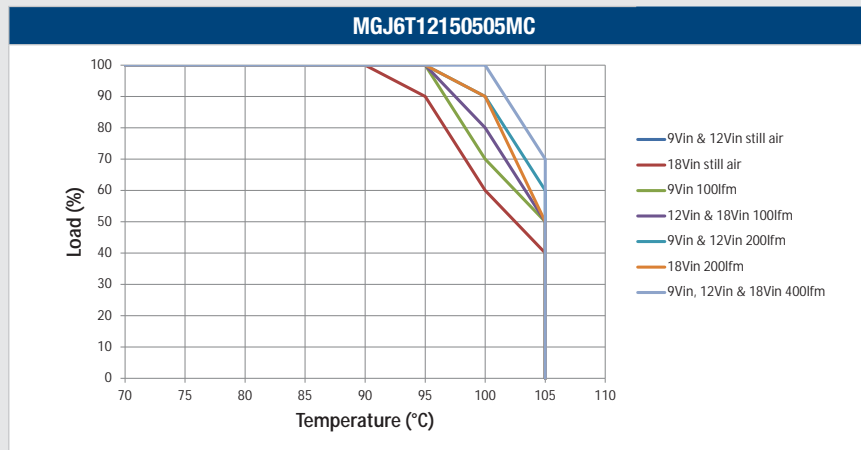
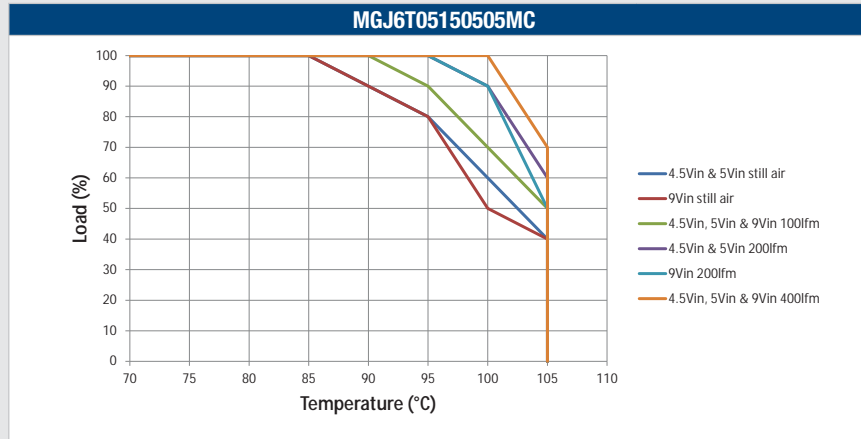

EMC FILTERING AND SPECTRA

FILTERING

The following filter circuit and filter table shows the input filters typically required to meet EN55022 Quasi-Peak Curve A or B.

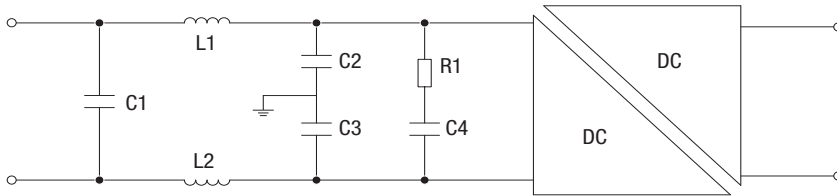

C1, C2 & C3 Polyester or ceramic capacitor

C4 Electrolytic capacitor (note R1 could be omitted if C4 has ESR \geq R1)

TO MEET CURVE B							
Part Number	C1	L1	L2	C2	C3	R1	C4
MGJ6T05150505MC	3.3 μ F	47100SC	10nF	10nF	500m Ω	470 μ F	
MGJ6T12150505MC	3.3 μ F	47100SC	10nF	10nF	500m Ω	470 μ F	
MGJ6T24150505MC	3.3 μ F	47100SC	10nF	10nF	500m Ω	470 μ F	

MGJ6T05150505MC

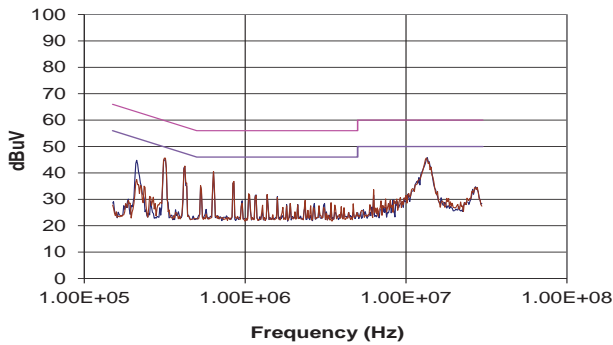

MGJ6T12150505MC

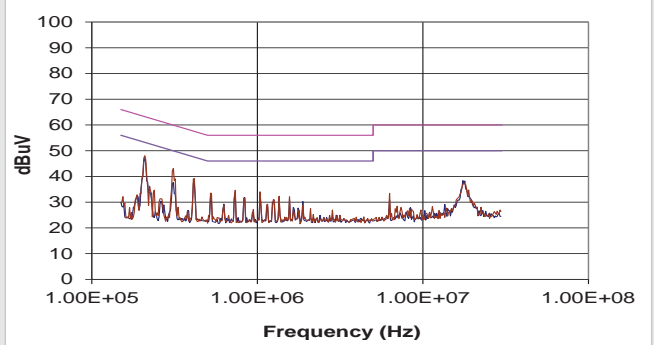

MGJ6T24150505MC

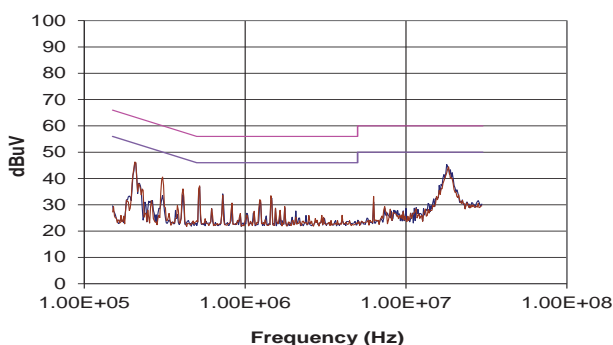

PACKAGE SPECIFICATIONS

MECHANICAL DIMENSIONS

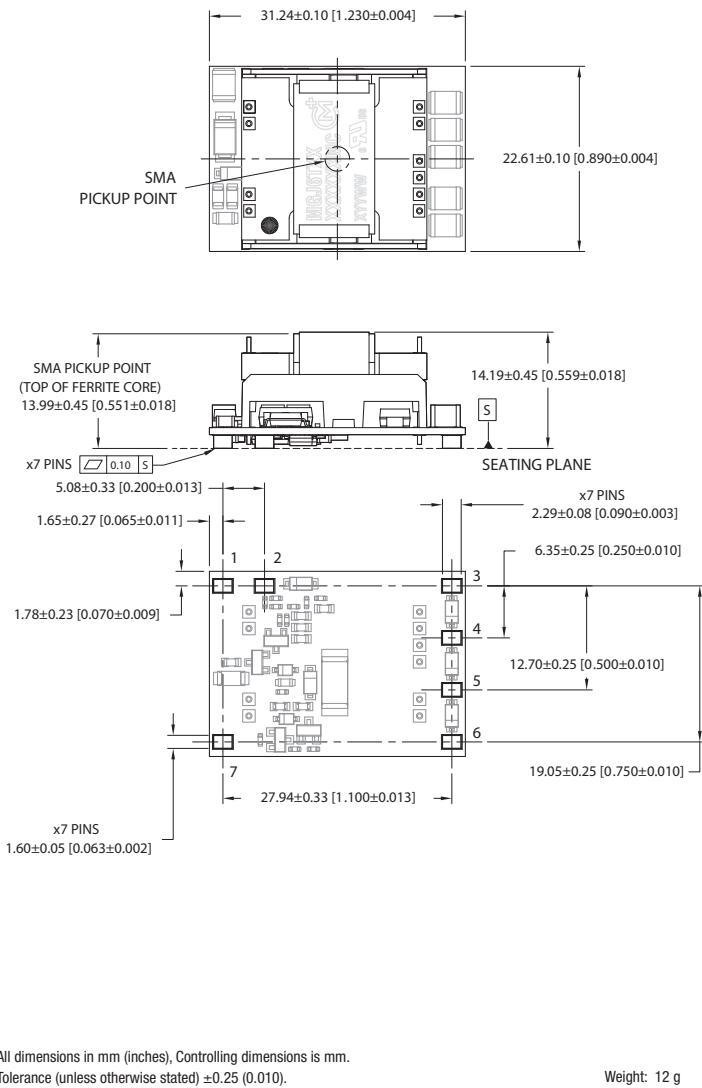

PIN CONNECTIONS

Pin	Function
1	-Vin
2	Dis/Sync
3	5VB RTN
4	5VA RTN
	5VB Out
5	15V RTN
	5VA Out
6	15 Vout
7	+Vin

RECOMMENDED FOOTPRINT DETAILS

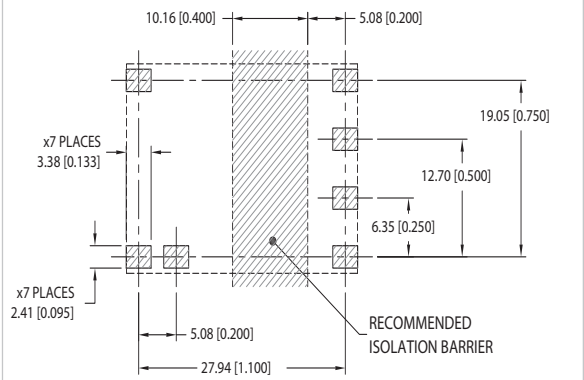

TAPE & REEL SPECIFICATIONS

REEL OUTLINE DIMENSIONS

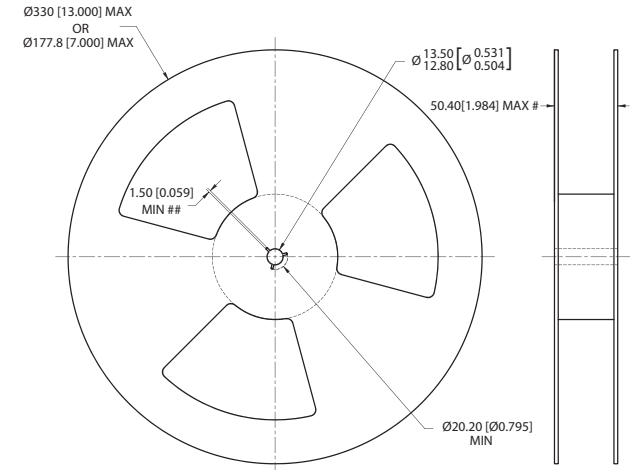

Tape & Reel specifications shall conform with current EIA-481 standard
 Unless otherwise stated all dimensions in mm(inches)
 Controlling dimension is mm
 # Measured at hub
 ## Six equi-spaced slots on 180mm/7" reel

REEL PACKAGING DETAILS

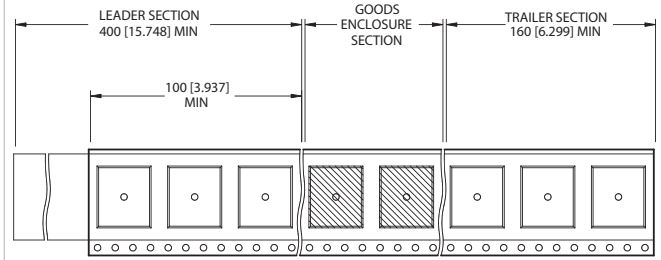

Reel Quantity: 7" - 23 or 13" - 92

TAPE OUTLINE DIMENSIONS

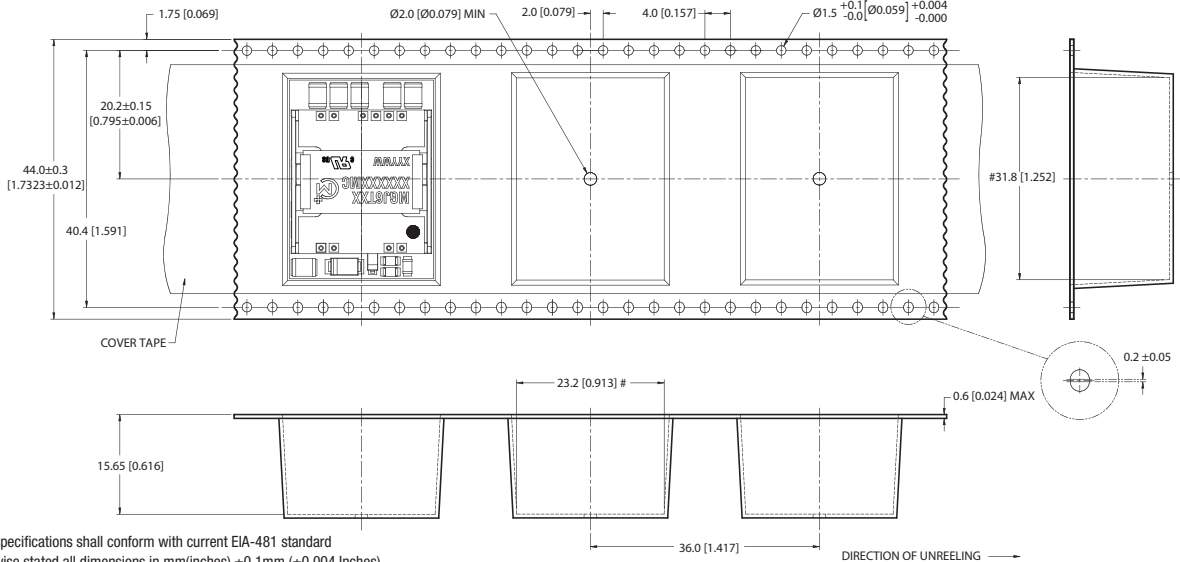

Tape & Reel specifications shall conform with current EIA-481 standard
 Unless otherwise stated all dimensions in mm(inches) ±0.1mm (±0.004 Inches)
 Controlling dimension is mm
 Components shall be orientated within the carrier tape as indicated
 # Measured on a plane 0.3mm above the bottom pocket

Murata Power Solutions, Inc.
 11 Cabot Boulevard, Mansfield, MA 02048-1151 U.S.A.
 ISO 9001 and 14001 REGISTERED



This product is subject to the following **operating requirements** and the **Life and Safety Critical Application Sales Policy**:
 Refer to: <http://www.murata-ps.com/requirements/>

Murata Power Solutions, Inc. makes no representation that the use of its products in the circuits described herein, or the use of other technical information contained herein, will not infringe upon existing or future patent rights. The descriptions contained herein do not imply the granting of licenses to make, use, or sell equipment constructed in accordance therewith. Specifications are subject to change without notice.
 © 2016 Murata Power Solutions, Inc.