

### FEATURES

- UL 60950 Recognized
- RoHS compliant
- Efficiency to 89% (Typ.)
- Power density to 0.85W/cm<sup>3</sup>
- Wide temperature performance at full 1 Watt load, -40°C to 85°C
- UL 94V-0 package material
- No heatsink required
- Industry standard pinout
- 3kVDC isolation (1 minute) 'Hi Pot Test'
- 5V, 12V, 15V, 24V, & 48V inputs
- 5V, 9V, 12V, & 15V output
- Fully encapsulated with toroidal magnetics
- No external components required
- No electrolytic or tantalum capacitors

### PRODUCT OVERVIEW

The MEV series is the new high performance version of our 1W NMV series. The MEV series is more efficient and offers improved regulation performance from 1.8% for applications where a wide output voltage variation can not be tolerated. They are ideally suited for providing local supplies on control system boards with the added benefit of 3kVDC galvanic isolation to reduce switching noise. The MEV series is currently available in an industry SIP 7 or DIP 14 package.

### SELECTION GUIDE - SINGLE OUTPUT<sup>1</sup>

Order Code	Nominal Input Voltage	Output Voltage	Output Current	Input Current at Rated Load	Load Regulation (Typ)	Load Regulation (Max)	Ripple & Noise (Typ) <sup>2</sup>	Ripple & Noise (Max) <sup>2</sup>	Efficiency (Min)	Efficiency (Typ)	Isolation Capacitance	MTTF <sup>3</sup>	Package Style
	V	V	mA		%	%	mVp-p	mVp-p	%	%	pF	kHrs	
MEV1S0505SC	5	5	200	233	5.4	6.2	20	30	81	84	38	7684	SIP
MEV1S0509SC	5	9	111	227	4.2	5.5	12	20	83.5	86.5	42	7698	SIP
MEV1S0512SC	5	12	84	226	4.6	5.5	10	20	84	87	40	7175	SIP
MEV1S0515SC	5	15	67	225	4.5	5	8	15	85	87.5	39	6496	SIP
MEV1S1205SC	12	5	200	98	4.5	5	12	15	80	84	28	7569	SIP
MEV1S1209SC	12	9	111	96	3	3.3	8	15	83	86	50	7317	SIP
MEV1S1212SC	12	12	84	94	3	3.6	7	15	85.5	88	70	6647	SIP
MEV1S1215SC	12	15	67	94	2.5	2.9	7	15	83.5	88	59	6279	SIP
MEV1S1505SC	15	5	200	79	4	5	10	20	80	83.5	32	7167	SIP
MEV1S1509SC	15	9	111	77	2.5	3.5	8	20	82.5	86.5	52	6906	SIP
MEV1S1512SC	15	12	84	76	2.3	3.5	6	15	83.5	87.5	63	6523	SIP
MEV1S1515SC	15	15	67	76	2.5	3.5	6	15	85	89	87	5916	SIP
MEV1S2405SC	24	5	200	50	3.3	5	12	20	79	84	38	7391	SIP
MEV1S2409SC	24	9	111	48	2.2	3.5	8	20	81	86.5	56	6490	SIP
MEV1S2412SC	24	12	84	48	2	3.5	7	15	82	87.5	72	6772	SIP
MEV1S2415SC	24	15	67	48	1.8	3	7	15	82	87.5	83	5957	SIP
MEV1S4805SC	48	5	200	26	3.3	5	19	35	75.5	79.5	34	7354	SIP
MEV1S4809SC	48	9	111	25	2.4	3.5	13	25	78.5	82	54	7120	SIP
MEV1S4812SC	48	12	84	26	2	3	10	20	78	82	63	7088	SIP
MEV1S4815SC	48	15	67	26	1.9	3	9	20	79	82.5	74	7238	SIP
MEV1S0505DC	5	5	200	234	5.4	6.5	15	30	81	84	39	6884	DIP
MEV1S0509DC	5	9	111	228	4.2	5.5	9	20	83	86.5	40	6732	DIP
MEV1S0512DC	5	12	84	228	5.0	5.7	8	15	84	87	39	6153	DIP
MEV1S0515DC	5	15	67	226	4.4	5.5	8	15	84	87.5	38	5419	DIP
MEV1S1205DC	12	5	200	98	4.6	5.5	11	20	80	84	34	6644	DIP
MEV1S1209DC	12	9	111	96	3	3.5	8	15	82	86	50	6434	DIP
MEV1S1212DC	12	12	84	93	3.1	3.7	7	15	84	88	52	5653	DIP
MEV1S1215DC	12	15	67	94	2.5	3.3	6	15	83	88	60	5267	DIP
MEV1S1505DC	15	5	200	79	4	5.2	11	25	79	83.5	32	6332	DIP
MEV1S1509DC	15	9	111	77	2.6	3.3	7	20	81	86.5	52	6114	DIP
MEV1S1512DC	15	12	84	76	2.3	3	6	15	83	87.5	63	5767	DIP
MEV1S1515DC	15	15	67	75	2.5	3.2	6	15	84	89	87	5002	DIP
MEV1S2405DC	24	5	200	50	3.4	4.5	16	30	79	84	38	6488	DIP
MEV1S2409DC	24	9	111	48	2.3	3.3	9	20	82	86.5	55	5693	DIP
MEV1S2412DC	24	12	84	48	2	3	7	15	83	87.5	73	5736	DIP
MEV1S2415DC	24	15	67	48	1.8	3	6	15	83	87.5	84	4915	DIP

1. For dual output variants, see page 2.
2. See Ripple & Noise characterisation method.
3. Calculated using MIL-HDBK-217F FN2 with nominal input voltage at full load.

All specifications typical at T<sub>a</sub>=25°C, nominal input voltage and rated output current unless otherwise specified.



### SELECTION GUIDE - DUAL OUTPUT<sup>1</sup>

Order Code	Nominal Input Voltage	Output Voltage	Output Current	Input Current at Rated Load	Load Regulation (Typ)	Load Regulation (Max)	Ripple & Noise (Typ) <sup>2</sup>	Ripple & Noise (Max) <sup>2</sup>	Efficiency (Min)	Efficiency (Typ)	Isolation Capacitance	MTTF <sup>3</sup>	Package Style
	V	V	mA		%		mVp-p		%		pF	kHrs	
MEV1D0505SC	5	±5	±100	233	5.1	6.5	14	35	82	85	42	4585	SIP
MEV1D0509SC	5	±9	±56	228	4.1	5.2	11	30	84	87	42	4565	SIP
MEV1D0512SC	5	±12	±42	228	4.2	5.4	9	25	85	87.5	38	4114	SIP
MEV1D0515SC	5	±15	±33	225	4.0	5.2	9	25	85	88	38	3544	SIP
MEV1D1205SC	12	±5	±100	98	3.8	4.5	13	35	81	85	33	4179	SIP
MEV1D1209SC	12	±9	±56	95	2.7	3.5	10	25	83	87	53	4679	SIP
MEV1D1212SC	12	±12	±42	93	2.7	3.4	8	20	85	89.5	64	3932	SIP
MEV1D1215SC	12	±15	±33	94	2.2	3	7	20	85	88.5	74	3362	SIP
MEV1D1505SC	15	±5	±100	78	3.3	4.0	14	35	81	84.5	33	4058	SIP
MEV1D1509SC	15	±9	±56	76	2.2	2.9	10	30	83	87	47	4171	SIP
MEV1D1512SC	15	±12	±42	76	2.1	3.0	8	25	84	88	67	3746	SIP
MEV1D1515SC	15	±15	±33	75	2.3	3.0	7	20	87	90.5	112	3127	SIP
MEV1D2405SC	24	±5	±100	49	2.9	4.0	13	35	81	84	36	4648	SIP
MEV1D2409SC	24	±9	±56	47	1.9	2.7	12	35	83	86	52	4574	SIP
MEV1D2412SC	24	±12	±42	47	1.8	2.7	10	30	85	88	78	4009	SIP
MEV1D2415SC	24	±15	±33	47	1.5	2.4	9	25	84	88	81	3232	SIP
MEV1D4805SC	48	±5	±100	26	2.6	3.3	21	50	77	80	32	4791	SIP
MEV1D4809SC	48	±9	±56	25	1.6	2.4	14	40	80	83	54	3843	SIP
MEV1D4812SC	48	±12	±42	25	1.4	2.2	13	35	81	84	79	3301	SIP
MEV1D4815SC	48	±15	±33	25	1.3	2.2	12	30	82	85	79	2977	SIP
MEV1D0505DC	5	±5	±100	233	5.1	6.5	14	35	82	85	42	4585	DIP
MEV1D0509DC	5	±9	±56	228	4.1	5.2	11	30	84	87	42	4565	DIP
MEV1D0512DC	5	±12	±42	228	4.2	5.4	9	25	85	87.5	38	4114	DIP
MEV1D0515DC	5	±15	±33	225	4.0	5.2	9	25	85	88	38	3544	DIP
MEV1D1205DC	12	±5	±100	98	3.8	4.5	13	35	81	85	33	4179	DIP
MEV1D1209DC	12	±9	±56	95	2.7	3.5	10	25	83	87	53	4679	DIP
MEV1D1212DC	12	±12	±42	93	2.7	3.4	8	20	85	89.5	64	3932	DIP
MEV1D1215DC	12	±15	±33	94	2.2	3	7	20	85	88.5	74	3362	DIP
MEV1D1505DC	15	±5	±100	78	3.3	4	14	35	81	84.5	33	4058	DIP
MEV1D1509DC	15	±9	±56	76	2.2	2.9	10	30	83	87	47	4171	DIP
MEV1D1512DC	15	±12	±42	76	2.1	3.0	8	25	84	88	67	3746	DIP
MEV1D1515DC	15	±15	±33	75	2.3	3.0	7	20	87	90.5	112	3127	DIP
MEV1D2405DC	24	±5	±100	49	2.9	4	13	35	81	84	36	4648	DIP
MEV1D2409DC	24	±9	±56	47	1.9	2.7	12	35	83	86	52	4574	DIP
MEV1D2412DC	24	±12	±42	47	1.8	2.7	10	30	85	88	78	4009	DIP
MEV1D2415DC	24	±15	±33	47	1.5	2.4	9	25	84	87.5	81	3232	DIP

1. For single output variants, see page 1.

2. See Ripple & Noise characterisation method.

3. Calculated using MIL-HDBK-217F FN2 with nominal input voltage at full load.

All specifications typical at T<sub>a</sub>=25°C, nominal input voltage and rated output current unless otherwise specified.

INPUT CHARACTERISTICS					
Parameter	Conditions	Min.	Typ.	Max.	Units
Voltage range	Continuous operation, 5V input types	4.5	5	5.5	V
	Continuous operation, 12V input types	10.8	12	13.2	
	Continuous operation, 15V input types	13.5	15	16.5	
	Continuous operation, 24V input types	21.6	24	26.4	
	Continuous operation, 48V input types	43.2	48	52.8	
Reflected ripple current	5V input types		11	20	mA p-p
	12V input types		5	15	
	15V input types		3.5	10	
	24V input types		4.7	15	
	48V input types		22	50	

OUTPUT CHARACTERISTICS					
Parameter	Conditions	Min.	Typ.	Max.	Units
Rated Power	T <sub>A</sub> =-40°C to 85°C			1	W
Voltage Set Point Accuracy	See tolerance envelope				
Line regulation	High V <sub>IN</sub> to low V <sub>IN</sub>		1.05	1.1	%/%

ISOLATION CHARACTERISTICS					
Parameter	Conditions	Min.	Typ.	Max.	Units
Isolation test voltage	Flash tested for 1 minute	3000			VDC
Resistance	Viso= 1000VDC	10			GΩ

GENERAL CHARACTERISTICS					
Parameter	Conditions	Min.	Typ.	Max.	Units
Switching frequency - single output types	5V input types		60		kHz
	12V input types & MEV1Sx1515xC		75		
	24V input types & MEV1Sx1505SxC, MEV1Sx1509SxC, MEV1Sx1512SxC		85		
	48V input types		65		
Switching frequency - dual output types	MEV1D4812xC, MEV1D4815xC		55		kHz
	MEV1D05xxC, MEV1D1212xC, MEV1D1515xC, MEV1D4805xC, MEV1D4809xC		60		
	MEV1D1205xC, MEV1D2412xC		75		
	MEV1D1209xC, MEV1D1215xC, MEV1D1505xC, MEV1D1512xC, MEV1D2405xC, MEV1D2415xC		80		
	MEV1D1509xC, MEV1D2409xC		90		

TEMPERATURE CHARACTERISTICS					
Parameter	Conditions	Min.	Typ.	Max.	Units
Specification	All output types	-40		85	°C
Storage		-50		125	
Case Temperature above ambient	24V & 48V input types			20	
	All other types			15	
Cooling	Free air convection				

ABSOLUTE MAXIMUM RATINGS	
Lead temperature 1.5mm from case for 10 seconds	300°C
Input voltage V <sub>IN</sub> , MEV05 types	7V
Input voltage V <sub>IN</sub> , MEV12 types	15V
Input voltage V <sub>IN</sub> , MEV15 types	18V
Input voltage V <sub>IN</sub> , MEV24 types	28V
Input voltage V <sub>IN</sub> , MEV48 types	54V

**TEMPERATURE DERATING GRAPH**

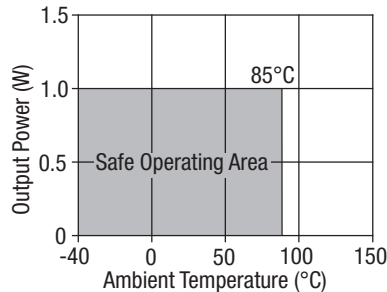

**TOLERANCE ENVELOPE**

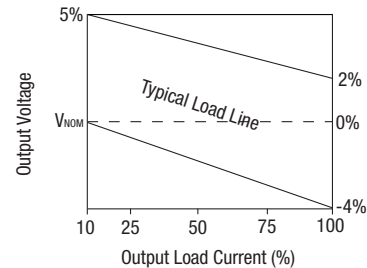

The voltage tolerance envelope shows typical load regulation characteristics for this product series. The tolerance envelope is the maximum output voltage variation due to changes in output loading.

**TECHNICAL NOTES**

**ISOLATION VOLTAGE**

'Hi Pot Test', 'Flash Tested', 'Withstand Voltage', 'Proof Voltage', 'Dielectric Withstand Voltage' & 'Isolation Test Voltage' are all terms that relate to the same thing, a test voltage, applied for a specified time, across a component designed to provide electrical isolation, to verify the integrity of that isolation.

Murata Power Solutions MEV1 series of DC/DC converters are all 100% production tested at their stated isolation voltage. This is 3kVDC for 1 minute.

A question commonly asked is, "What is the continuous voltage that can be applied across the part in normal operation?"

The MEV1 has been recognized by Underwriters Laboratory for functional insulation, both input and output should normally be maintained within SELV limits i.e. less than 42.4V peak, or 60VDC. The isolation test voltage represents a measure of immunity to transient voltages and the part should never be used as an element of a safety isolation system. The part could be expected to function correctly with several hundred volts offset applied continuously across the isolation barrier; but then the circuitry on both sides of the barrier must be regarded as operating at an unsafe voltage and further isolation/insulation systems must form a barrier between these circuits and any user-accessible circuitry according to safety standard requirements.

**REPEATED HIGH-VOLTAGE ISOLATION TESTING**

It is well known that repeated high-voltage isolation testing of a barrier component can actually degrade isolation capability, to a lesser or greater degree depending on materials, construction and environment. The MEV1 series has toroidal isolation transformers, with no additional insulation between primary and secondary windings of enameled wire. While parts can be expected to withstand several times the stated test voltage, the isolation capability does depend on the wire insulation. Any material, including this enamel (typically polyurethane) is susceptible to eventual chemical degradation when subject to very high applied voltages thus implying that the number of tests should be strictly limited. We therefore strongly advise against repeated high voltage isolation testing, but if it is absolutely required, that the voltage be reduced by 20% from specified test voltage.

This consideration equally applies to agency recognized parts rated for better than functional isolation where the wire enamel insulation is always supplemented by a further insulation system of physical spacing or barriers.

**SAFETY APPROVAL**

The MEV1 series has been recognized by Underwriters Laboratory (UL) to UL 60950 for functional insulation in a maximum still air ambient temperature of 85°C and/or case temperature limit (case temperature measured on the face opposite the pins) as follows:

- MEV1SxxxxSC: 130°C
- MEV1SxxxxDC: 130°C
- MEV1DxxxxSC: 94°C
- MEV1DxxxxDC: 96°C

The MEV1 Series of converters are not internally fused so to meet the requirements of UL 60950 an anti-surge input line fuse should always be used with ratings as defined below.

- MEV1x05xxxC: 1A
- MEV1x12xxxC: 0.375A
- MEV1x15xxxC: 0.375A
- MEV1x24xxxC: 0.2A
- MEV1x48xxxC: 0.1A

All fuses should be UL recognized and rated to at least the maximum allowable DC input voltage.

File number E151252 applies.

**RoHS COMPLIANT INFORMATION**



This series is compatible with RoHS soldering systems with a peak wave solder temperature of 300°C for 10 seconds. The pin termination finish on the SIP package type is Tin Plate, Hot Dipped over Matte Tin with Nickel Preplate. The DIP types are Matte Tin over Nickel Preplate. Both types in this series are backward compatible with Sn/Pb soldering systems.

For further information, please visit [www.murata-ps.com/rohs](http://www.murata-ps.com/rohs)

## APPLICATION NOTES

### Minimum load

The minimum load to meet datasheet specification is 10% of the full rated load across the specified input voltage range. Lower than 10% minimum loading will result in an increase in output voltage, which may rise to typically double the specified output voltage if the output load falls to less than 5%.

### Capacitive loading and start up

Typical start up times for this series, with a typical input voltage rise time of 2.2µs and output capacitance of 10µF, are shown in the table below. The product series will start into a capacitance of 47µF with an increased start time, however, the maximum recommended output capacitance is 10µF.

Start-up time		Start-up time	
µs		µs	
MEV1x0505xC	585	MEV1x1512xC	3045
MEV1x0509xC	1550	MEV1x1515xC	4445
MEV1x0512xC	2700	MEV1x2405xC	440
MEV1x0515xC	4320	MEV1x2409xC	4355
MEV1x1205xC	605	MEV1x2412xC	1855
MEV1x1209xC	1750	MEV1x2415xC	2930
MEV1x1212xC	3000	MEV1x4805SC	580
MEV1x1215xC	4800	MEV1x4809SC	1320
MEV1x1505xC	660	MEV1x4812SC	2075
MEV1x1509xC	1720	MEV1x4815SC	3235

Typical Start-Up Wave Form

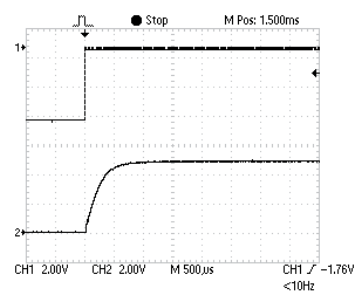

### Ripple & Noise Characterisation Method

Ripple and noise measurements are performed with the following test configuration.

C1	1µF X7R multilayer ceramic capacitor, voltage rating to be a minimum of 3 times the output voltage of the DC/DC converter
C2	10µF tantalum capacitor, voltage rating to be a minimum of 1.5 times the output voltage of the DC/DC converter with an ESR of less than 100mΩ at 100 kHz
C3	100nF multilayer ceramic capacitor, general purpose
R1	450Ω resistor, carbon film, ±1% tolerance
R2	50Ω BNC termination
T1	3T of the coax cable through a ferrite toroid
RLOAD	Resistive load to the maximum power rating of the DC/DC converter. Connections should be made via twisted wires

Measured values are multiplied by 10 to obtain the specified values.

### Differential Mode Noise Test Schematic

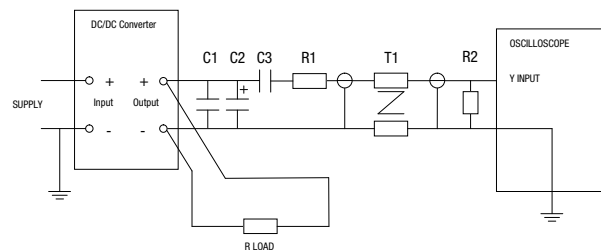

**APPLICATION NOTES (continued)**

**Output Ripple Reduction**

By using the values of inductance and capacitance stated, the output ripple at the rated load is lowered to 5mV p-p max.

**Component selection**

**Capacitor:** It is required that the ESR (Equivalent Series Resistance) should be as low as possible, ceramic types are recommended. The voltage rating should be at least twice (except for 15V output), the rated output voltage of the DC/DC converter.

**Inductor:** The rated current of the inductor should not be less than that of the output of the DC/DC converter. At the rated current, the DC resistance of the inductor should be such that the voltage drop across the inductor is <2% of the rated voltage of the DC/DC converter. The SRF (Self Resonant Frequency) should be >20MHz.

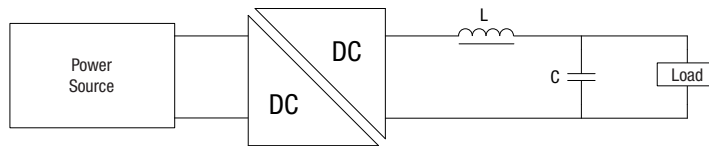

	Inductor			Capacitor
	L, $\mu$ H	SMD	Through Hole	C, $\mu$ F
MEV1x0505xC	10	82103C	11R103C	4.7
MEV1x0509xC	22	82223C	11R223C	2.2
MEV1x0512xC	47	82473C	11R473C	1
MEV1x0515xC	47	82473C	11R473C	1
MEV1x1205xC	10	82103C	11R103C	4.7
MEV1x1209xC	22	82223C	11R223C	2.2
MEV1x1212xC	47	82473C	11R473C	1
MEV1x1215xC	47	82473C	11R473C	1
MEV1x1505xC	10	82103C	11R103C	4.7
MEV1x1509xC	22	82223C	11R223C	2.2
MEV1x1512xC	47	82473C	11R473C	1
MEV1x1515xC	47	82473C	11R473C	1
MEV1x2405xC	10	82103C	11R103C	4.7
MEV1x2409xC	22	82223C	11R223C	2.2
MEV1x2412xC	47	82473C	11R473C	1
MEV1x2415xC	47	82473C	11R473C	1
MEV1x4805SC	10	82103C	11R103C	4.7
MEV1x4809SC	22	82223C	11R223C	2.2
MEV1x4812SC	47	82473C	11R473C	1
MEV1x4815SC	47	82473C	11R473C	1

## EFFICIENCY VS LOAD

**MEV1x05xxSC**

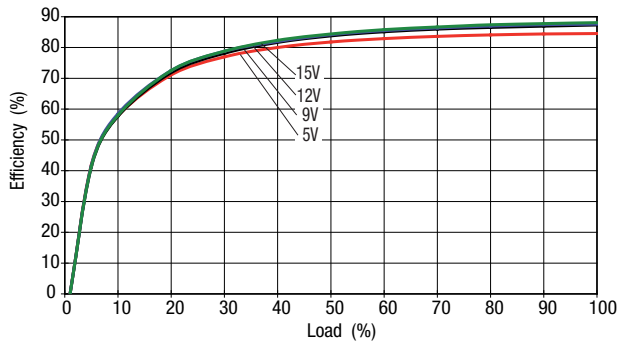

**MEV1x12xxSC**

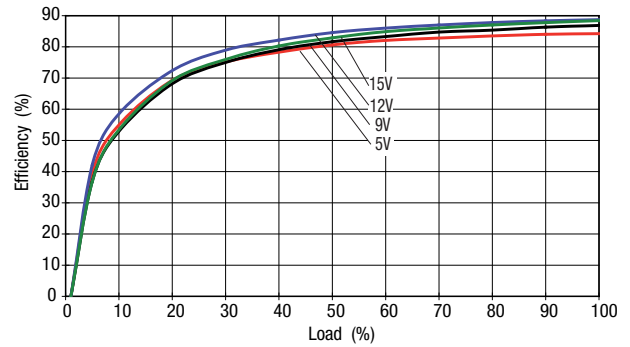

**MEV1x15xxSC**

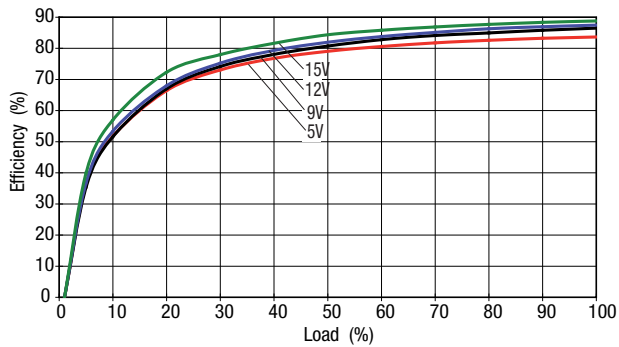

**MEV1x24xxSC**

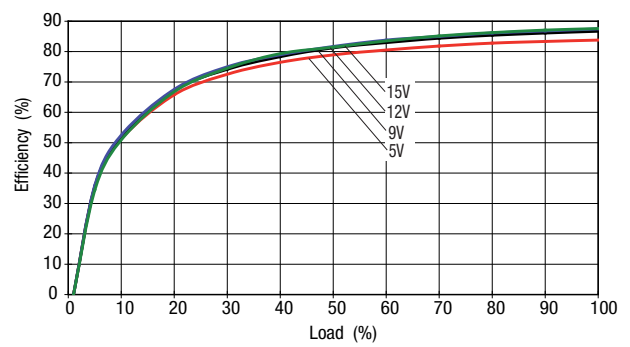

**MEV1x48xxSC**

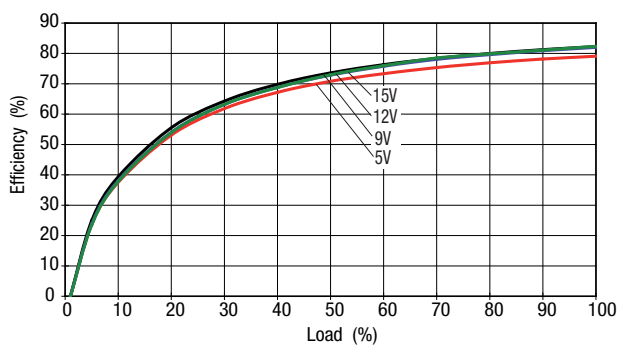

## EFFICIENCY VS LOAD

**MEV1x05xxDC**

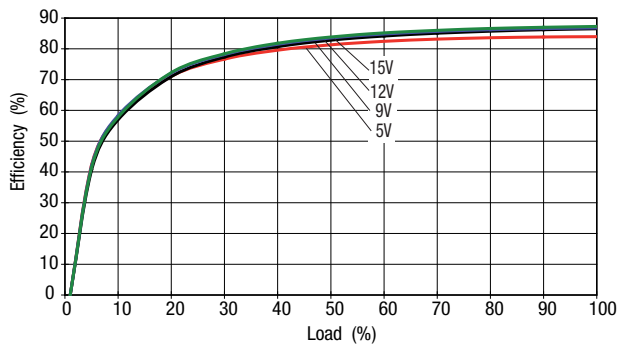

**MEV1x12xxDC**

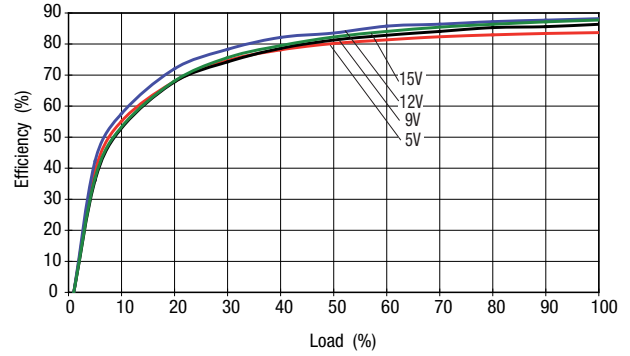

**MEV1x15xxDC**

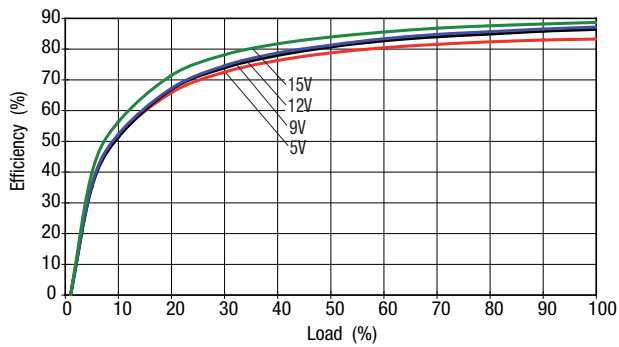

**MEV1x24xxDC**

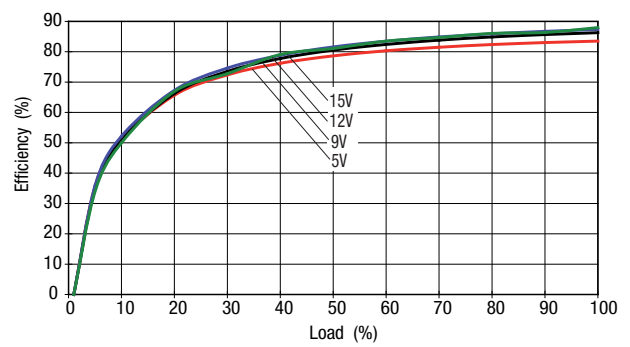



**PACKAGE SPECIFICATIONS**

**MECHANICAL DIMENSIONS**

**DIP package**

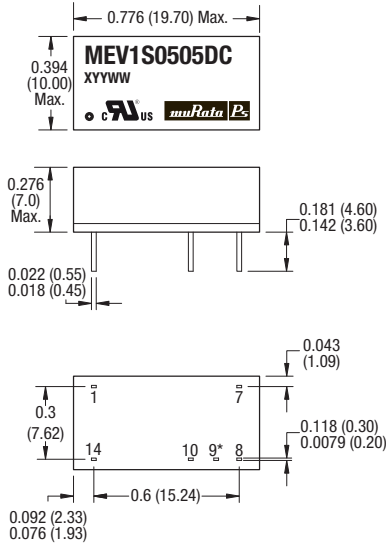

**SIP package**

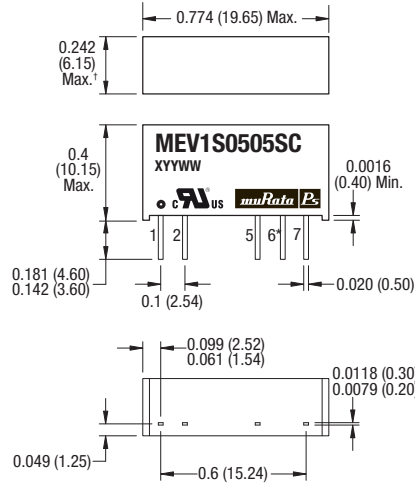

**PIN CONNECTIONS**

Single output variants

14 Pin DIP	
Pin	Function
1	-VIN
7	NC
8	+VOUT
10	-VOUT
14	+VIN

7 Pin SIP	
Pin	Function
1	+VIN
2	-VIN
5	-VOUT
7	+VOUT

Dual output variants

14 Pin DIP	
Pin	Function
1	-VIN
7	NC
8	+VOUT
9	OV
10	-VOUT
14	+VIN

7 Pin SIP	
Pin	Function
1	+VIN
2	-VIN
5	-VOUT
6	OV
7	+VOUT

\* Pin not fitted on single output variants.

† 48V input variants 0.301 (7.65)

All dimensions in inches  $\pm 0.01$  (mm  $\pm 0.25$ mm). All pins on a 0.1 (2.54) pitch and within  $\pm 0.01$  (0.25) of true position.

Weight:  
2.6g (DIP)  
2.8g (SIP - 48V variants)  
2.5g (all other SIP)

**PACKAGE SPECIFICATIONS (continued)**

**RECOMMENDED FOOTPRINT DETAILS**

14 Pin DIP Package

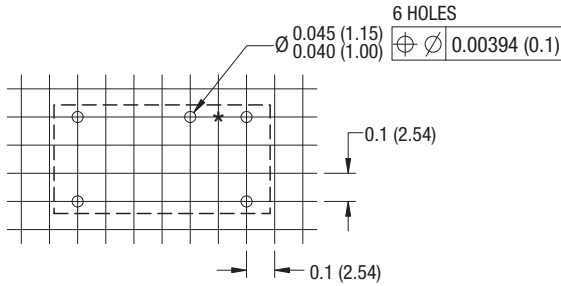

7 Pin SIP Package

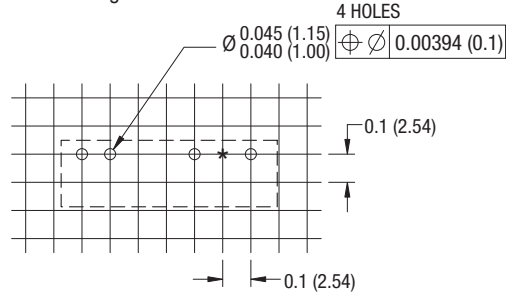

\* Hole not required for single output variants.

**TUBE OUTLINE DIMENSIONS**

14 Pin DIP Tube

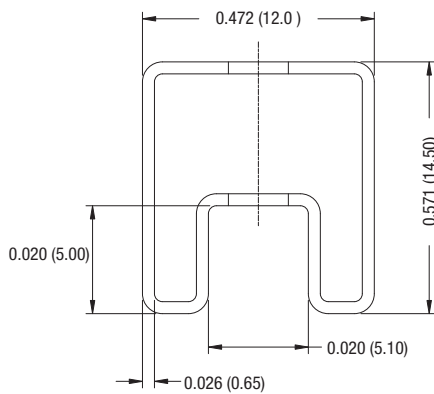

7 Pin SIP Tube

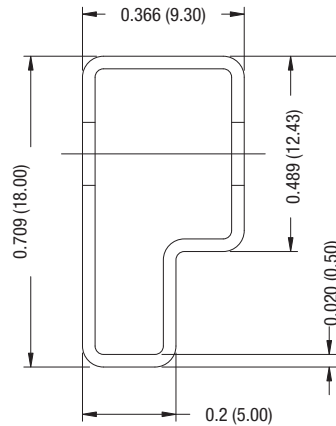

Unless otherwise stated all dimensions in inches (mm)  $\pm 0.5$ mm.  
 Tube length (14 Pin DIP) : 20.47 (520mm  $\pm 2$ mm).  
 Tube length (7 Pin SIP) : 20.47 (520mm  $\pm 2$ mm).

Tube Quantity : 25

Murata Power Solutions, Inc.  
 11 Cabot Boulevard, Mansfield, MA 02048-1151 U.S.A.  
 ISO 9001 and 14001 REGISTERED



This product is subject to the following **operating requirements** and the **Life and Safety Critical Application Sales Policy**:  
 Refer to: <http://www.murata-ps.com/requirements/>

Murata Power Solutions, Inc. makes no representation that the use of its products in the circuits described herein, or the use of other technical information contained herein, will not infringe upon existing or future patent rights. The descriptions contained herein do not imply the granting of licenses to make, use, or sell equipment constructed in accordance therewith. Specifications are subject to change without notice.  
 © 2015 Murata Power Solutions, Inc.