



## FEATURES

- RoHS compliant
- Toroidal construction
- Up to 4.1A I<sub>DC</sub>
- Inductance range from 0.5 to 5.0mH
- Small footprint
- UL 94V-0 packaging materials
- Low DC resistance
- Guaranteed 3.0mm creepage and clearance between windings

## PRODUCT OVERVIEW

The 5100 series is a range of through-hole common mode chokes designed to attenuate up to 100MHz common mode noise where line filtering is required, such as high current switching power supplies and telecom applications.

## SELECTION GUIDE

Order Code	Inductance		DC Current	DC Resistance	Leakage Inductance
	Nom. mH	Range mH	Max. A	Max. mΩ	Max. μH
<b>51504C</b>	0.5	0.37-0.68	4.1	27	9
<b>51105C</b>	1.0	0.75-1.39	3.3	38	18
<b>51305C</b>	3.0	2.16-4.02	1.9	97	45
<b>51505C</b>	5.0	3.62-6.73	1.2	197	75

## ABSOLUTE MAXIMUM RATINGS

Operating free air temperature range	-40°C to 125°C
Storage temperature range	-40°C to 125°C
Isolation voltage	1500Vrms

## SOLDERING INFORMATION<sup>1</sup>

Peak wave solder temperature	260°C
Pin finish	Tin

## PACKAGE SPECIFICATIONS

### Mechanical Dimensions

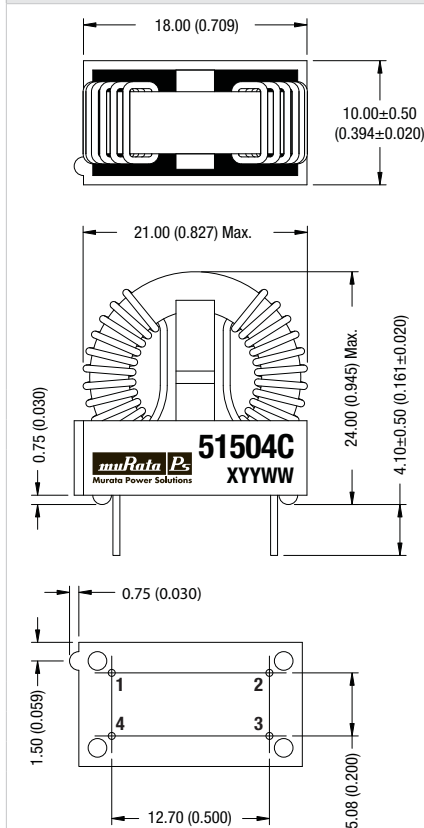

Package weight: 6.0g Typ.  
All dimensions in mm (inches)

### Recommended Footprint Details

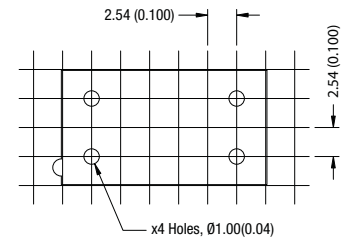

### Pin Connections

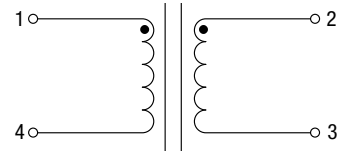

### Packaging

Supplied in trays (60 pieces per tray)

Specifications typical at T<sub>a</sub> = 25°C  
1 For further information, please visit [www.murata-ps.com/rohs](http://www.murata-ps.com/rohs)



**COMMON AND DIFFERENTIAL MODE ATTENUATION VS FREQUENCY**

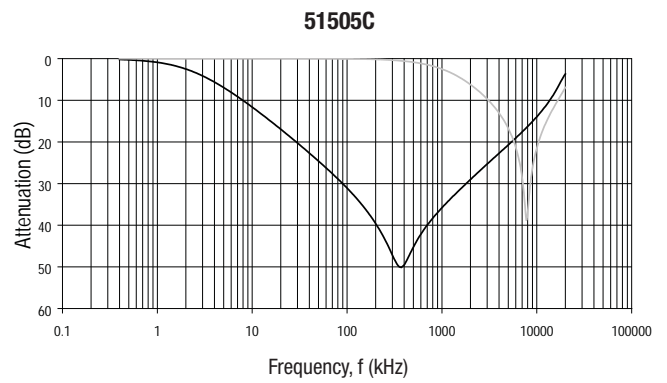
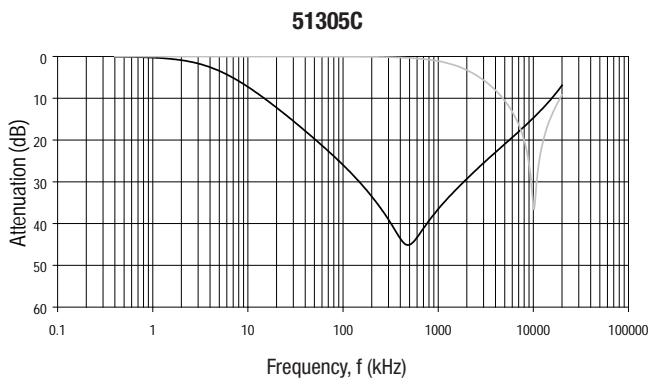
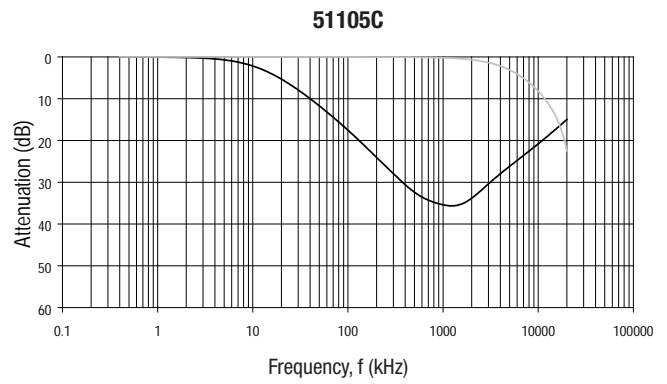
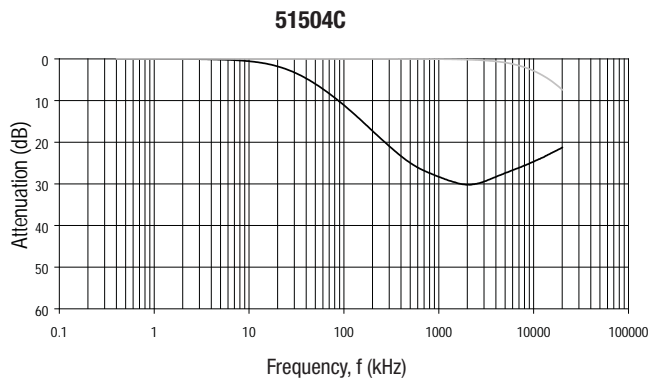

— Common Mode    - - - Differential Mode

Murata Power Solutions, Inc.  
 11 Cabot Boulevard, Mansfield, MA 02048-1151 U.S.A.  
 ISO 9001 and 14001 REGISTERED

Murata Power Solutions, Inc. makes no representation that the use of its products in the circuits described herein, or the use of other technical information contained herein, will not infringe upon existing or future patent rights. The descriptions contained herein do not imply the granting of licenses to make, use, or sell equipment constructed in accordance therewith. Specifications are subject to change without notice.  
 © 2011 Murata Power Solutions, Inc.