



FEATURES

- RoHS compliant
- 4 Configurations
- Primary inductance to 10mH
- 1kVrms isolation
- Industry standard pinout
- Surface mount option
- UL 94 V-0 package materials
- Low profile
- Toroidal construction
- Fully encapsulated

DESCRIPTION

The 786 series is a comprehensive range of general purpose pulse transformers. Common applications include line coupling, matching or isolating. The devices can also be used in small isolated power supplies and also as common-mode chokes in filtering applications.

Surface-mount parts

The surface-mount (M suffix) products are not recommended for new designs. For existing designs, however, Murata Power Solutions will continue to manufacture and fully support these parts.

For recommended alternatives please refer to the 786J Series datasheet.

SELECTION GUIDE

| Order Code | Turns Ratio | Min. Primary Inductance | Primary Min. Volt-time Product, Et | Typ. Leakage Inductance | Typ. Interwinding Capacitance | Max. DC Resistance | Isolation Voltage | Winding Configuration |
|------------|-------------|-------------------------|------------------------------------|-------------------------|-------------------------------|--------------------|-------------------|-----------------------|
| | | μH | Vμs | μH | pF | Ω | | |
| 78601/4C | 1:1 | 67 | 4 | 0.19 | 8 | 0.17 | 1000 | 1 |
| 78601/3C | 1:1 | 200 | 6 | 0.20 | 14 | 0.25 | | |
| 78601/2C | 1:1 | 500 | 10 | 0.25 | 22 | 0.34 | | |
| 78601/8C | 1:1 | 1000 | 15 | 0.29 | 35 | 0.45 | | |
| 78601/1C | 1:1 | 2000 | 20 | 0.47 | 49 | 0.60 | 1000 | 2 |
| 78601/16C | 1:1 | 4000 | 28 | 0.47 | 78 | 0.84 | | |
| 78601/9C | 1:1 | 10000 | 56 | 0.86 | 121 | 1.30 | | |
| 78602/4C | 1:1:1 | 67 | 4 | 0.11 | 12 | 0.18 | | |
| 78602/3C | 1:1:1 | 200 | 6 | 0.17 | 19 | 0.24 | 1000 | 1 |
| 78602/2C | 1:1:1 | 500 | 10 | 0.27 | 32 | 0.34 | | |
| 78602/8C | 1:1:1 | 1000 | 15 | 0.35 | 47 | 0.46 | | |
| 78602/1C | 1:1:1 | 2000 | 20 | 0.60 | 72 | 0.66 | | |
| 78602/16C | 1:1:1 | 4000 | 28 | 0.71 | 116 | 0.92 | 1000 | 3 |
| 78602/9C | 1:1:1 | 10000 | 56 | 0.71 | 167 | 1.34 | | |
| 78604/4C | 2:1 | 67 | 4 | 0.41 | 4 | 0.18 | | |
| 78604/3C | 2:1 | 200 | 6 | 0.49 | 9 | 0.25 | | |
| 78604/2C | 2:1 | 500 | 10 | 0.65 | 13 | 0.34 | 1000 | 1 |
| 78604/8C | 2:1 | 1000 | 15 | 0.76 | 20 | 0.46 | | |
| 78604/1C | 2:1 | 2000 | 20 | 0.99 | 29 | 0.60 | | |
| 78604/16C | 2:1 | 4000 | 28 | 1.61 | 50 | 0.85 | | |
| 78604/9C | 2:1 | 10000 | 56 | 1.64 | 72 | 1.23 | 1000 | 4 |
| 78613/4C | 1CT:1 | 67 | 4 | 0.30 | 7 | 0.20 | | |
| 78613/3C | 1CT:1 | 200 | 6 | 0.65 | 12 | 0.25 | | |
| 78613/2C | 1CT:1 | 500 | 10 | 1.07 | 20 | 0.36 | | |
| 78613/8C | 1CT:1 | 1000 | 15 | 1.13 | 35 | 0.48 | 1000 | 3 |
| 78613/1C | 1CT:1 | 2000 | 20 | 1.53 | 47 | 0.63 | | |
| 78613/16C | 1CT:1 | 4000 | 28 | 1.98 | 64 | 0.88 | | |
| 78613/9C | 1CT:1 | 10000 | 56 | 3.83 | 72 | 1.33 | | |
| 78615/4C | 1CT:1CT | 67 | 4 | 1.21 | 3 | 0.17 | 1000 | 4 |
| 78615/3C | 1CT:1CT | 200 | 6 | 3.64 | 5 | 0.24 | | |
| 78615/2C | 1CT:1CT | 500 | 10 | 6.86 | 7 | 0.34 | | |
| 78615/8C | 1CT:1CT | 1000 | 15 | 11.9 | 10 | 0.45 | | |
| 78615/1C | 1CT:1CT | 2000 | 20 | 16.0 | 16 | 0.60 | 1000 | 4 |
| 78615/16C | 1CT:1CT | 4000 | 28 | 37.7 | 20 | 0.87 | | |
| 78615/9C | 1CT:1CT | 10000 | 56 | 44.5 | 19 | 1.33 | | |

ORDER CODE DETAILS

| Order Code | Package Type | Packaging Type | Quantity |
|-------------|--------------|----------------|----------|
| 786XX/XC | 6 Pin DIL | Tube | 50 |
| 786XX/XMC | 6 Pin SM | Tube | 50 |
| 786XX/XMC-R | 6 Pin SM | Tape & Reel | 500 |

ABSOLUTE MAXIMUM RATINGS

| | |
|--------------------------------------|----------------|
| Operating free air temperature range | 0°C to 70°C |
| Storage temperature range | -60°C to 125°C |

SOLDERING INFORMATION¹

| | |
|--------------------------------------|----------------------|
| Pin finish | Matte tin |
| Peak wave solder temperature | 300°C for 10 seconds |
| Peak reflow temperature ² | 220°C |

All specifications typical at T_A=25°C

1 For further information, please visit www.murata-ps.com/rohs

2 For higher temperature reflow variants see 786J series datasheet



PACKAGE SPECIFICATIONS

MECHANICAL DIMENSIONS

6 Pin DIL Package Style

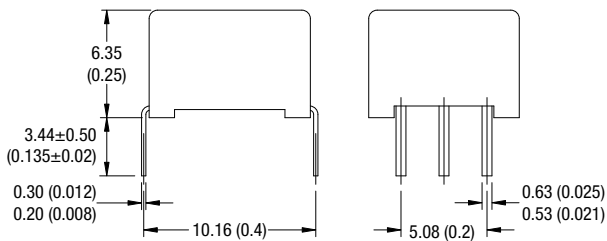
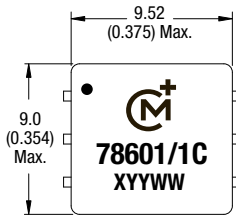

6 Pin SMD Package Style

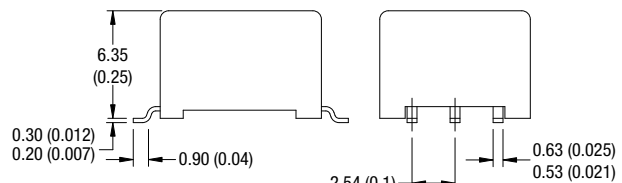
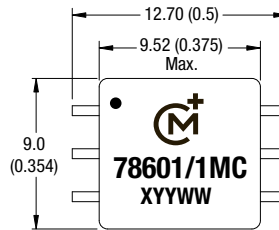

Unless otherwise stated all dimensions in mm (inches) ±0.25 (0.01). All pins on a 2.54 (0.1) pitch and within ±0.25 (0.01) of true position. Package Weight: 1.1g Typ.

RECOMMENDED FOOTPRINT DETAILS

6 Pin DIL

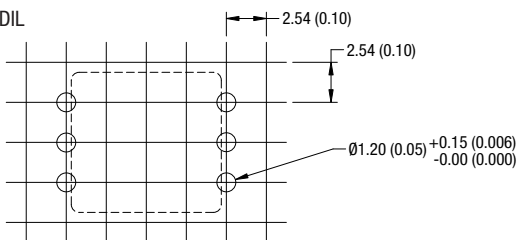

6 Pin SM

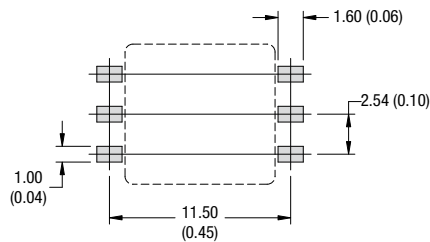

Unless otherwise stated all dimensions in mm (inches) ±0.25 (0.01). All pins on a 2.54 (0.1) pitch and within ±0.25 (0.01) of true position.

WINDING CONFIGURATION - 6 PIN DIL/SMD (TOP VIEW)

1

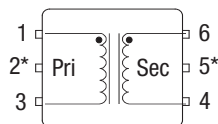

2

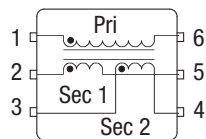

3

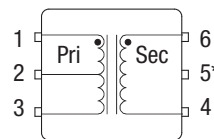

4

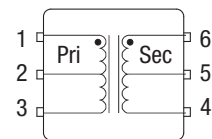

* Pins only fitted on 786XX/XMC and 786XX/XMC-R variants.

TAPE & REEL SPECIFICATIONS

REEL OUTLINE DIMENSIONS

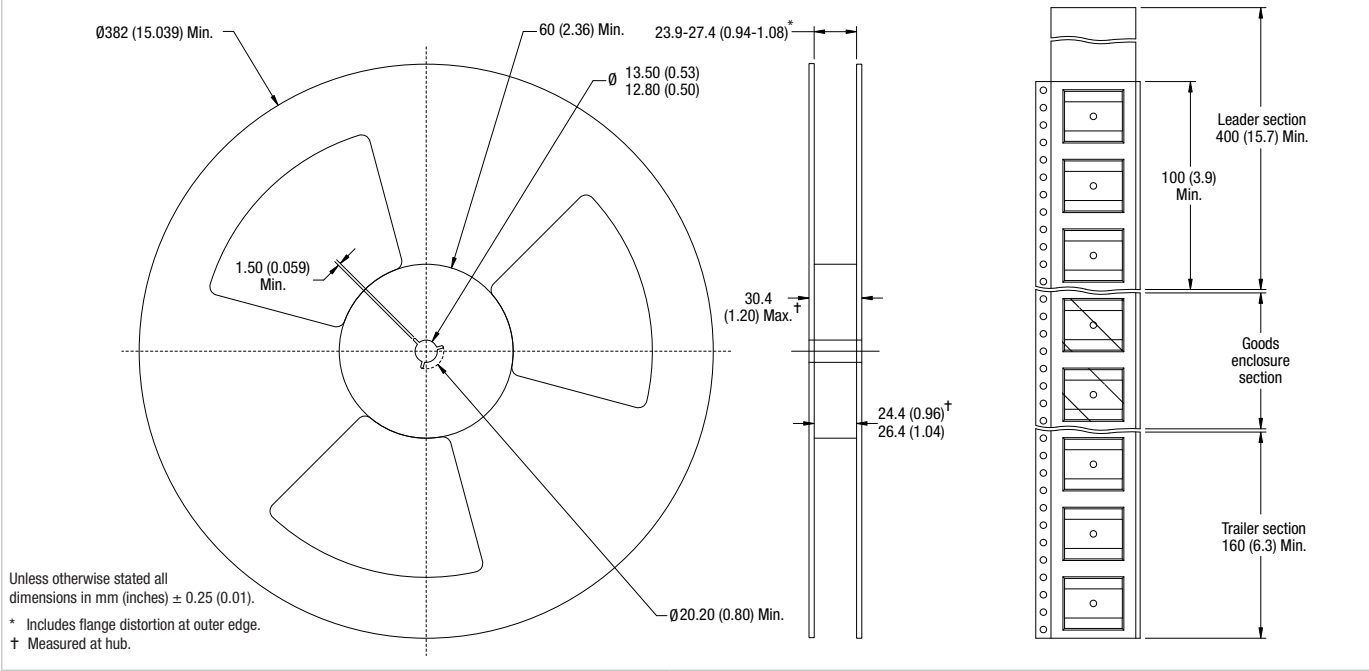

TAPE OUTLINE DIMENSIONS

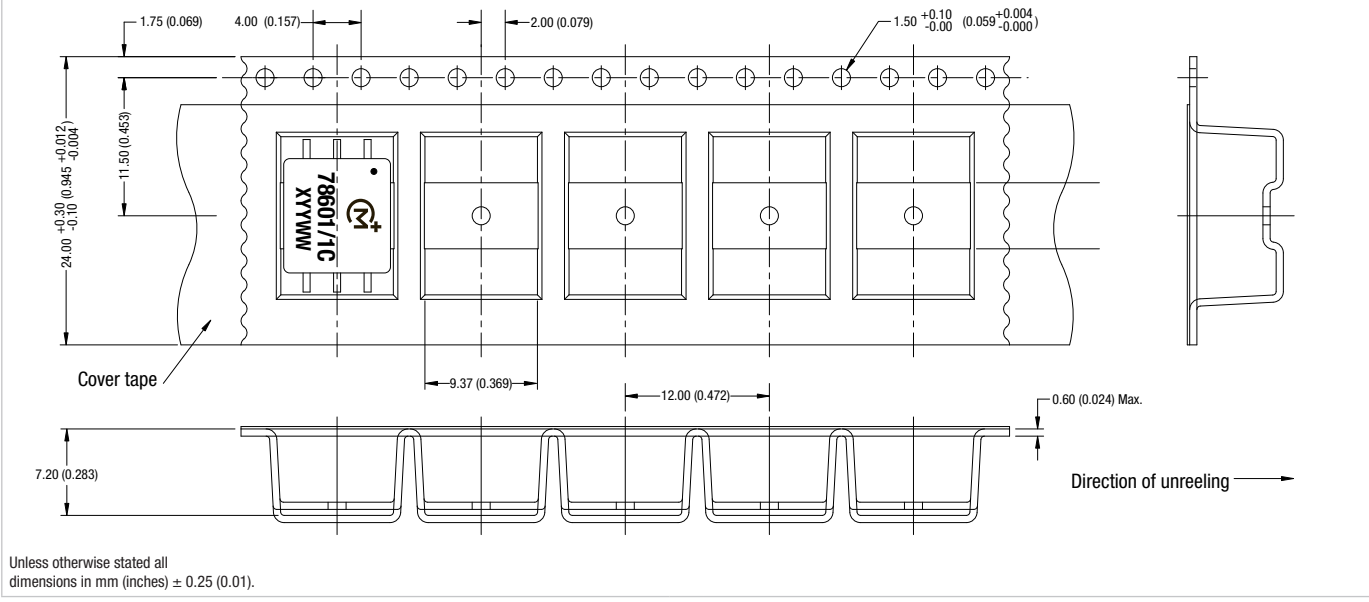

TUBE OUTLINE DIMENSIONS



Tube length: 465±2 (18.3±0.08). Tube quantity: 50.
 Tube material: Antistatic coated clear pvc.
 Unless otherwise stated all dimensions in mm (inches) ±0.25 (0.01).

TECHNICAL NOTES

ISOLATION VOLTAGE

'Hi Pot Test', 'Flash Tested', 'Withstand Voltage', 'Proof Voltage', 'Dielectric Withstand Voltage' & 'Isolation Test Voltage' are all terms that relate to the same thing, a test voltage, applied for a specified time, across a component designed to provide electrical isolation, to verify the integrity of that isolation.

All products in this series are 100% production tested at their stated isolation voltage.

A question commonly asked is, "What is the continuous voltage that can be applied across the part in normal operation?"

For a part holding no specific agency approvals both input and output should normally be maintained within SELV limits i.e. less than 42.4V peak, or 60VDC. The isolation test voltage represents a measure of immunity to transient voltages and the part should never be used as an element of a safety isolation system. The part could be expected to function correctly with several hundred volts offset applied continuously across the isolation barrier; but then the circuitry on both sides of the barrier must be regarded as operating at an unsafe voltage and further isolation/insulation systems must form a barrier between these circuits and any user-accessible circuitry according to safety standard requirements.

REPEATED HIGH-VOLTAGE ISOLATION TESTING

It is well known that repeated high-voltage isolation testing of a barrier component can actually degrade isolation capability, to a lesser or greater degree depending on materials, construction and environment. This series has toroidal isolation transformers, with no additional insulation between primary and secondary windings of enameled wire. While parts can be expected to withstand several times the stated test voltage, the isolation capability does depend on the wire insulation. Any material, including this enamel (typically polyurethane) is susceptible to eventual chemical degradation when subject to very high applied voltages thus implying that the number of tests should be strictly limited. We therefore strongly advise against repeated high voltage isolation testing, but if it is absolutely required, that the voltage be reduced by 20% from specified test voltage.

This consideration equally applies to agency recognized parts rated for better than functional isolation where the wire enamel insulation is always supplemented by a further insulation system of physical spacing or barriers.