



FEATURES

- UL 60950 recognised
- Wide temperature performance at full 1 watt load, -40°C to 60°C
- Single and dual outputs
- SIP package style
- 5.2kVDC isolation 'Hi Pot Test'
- 3V, 5V & 12V input
- 3V, 5V, 9V, 12V and 15V output
- Internal SMD construction
- Pin compatible with the CRV1, NMV, MEV1, MMV1, MEJ1 series SIP DC/DC converters
- MTTF up to 13 million hours
- Custom solutions available

PRODUCT OVERVIEW

The NMJ series are dual and single output DC/DC converters in a 7 pin SIP package style offering pin and functionality compatibility with the NMV series SIP DC/DC converters. The NMJ series is UL60950 recognized and suitable for applications where safety and miniaturisation are of paramount importance. Isolation barrier approved for supplementary/reinforced insulation - see page 2.

SELECTION GUIDE

Order Code	Nominal Input Voltage	Output Voltage	Output Current	Ripple & Noise ²	Efficiency (Min.)	Isolation Capacitance	MTTF ¹
	V	V	mA	mV p-p	%	pF	kHrs
NMJ0505SC	5	±5	±100	40	60	3.0	4950
NMJ0509SC	5	±9	±55	30	65	3.0	3832
NMJ0512SC	5	±12	±42	20	65	3.0	2770
NMJ0515SC	5	±15	±33	20	65	3.0	1903
NMJ1205SC	12	±5	±100	40	60	3.0	3688
NMJ1209SC	12	±9	±55	30	65	3.0	3029
NMJ1212SC	12	±12	±42	20	65	3.0	2324
NMJ1215SC	12	±15	±33	20	65	3.0	1682
NMJ0303SAC	3.3	3.3	303	70	66	3.0	13780
NMJ0503SAC	5	3.3	303	60	64	3.0	13460
NMJ0505SAC	5	5	200	50	68	3.0	13360
NMJ0509SAC	5	9	111	50	72	3.0	12700
NMJ0512SAC	5	12	83	50	71	3.0	11490
NMJ0515SAC	5	15	66	50	71	3.0	9980
NMJ1205SAC	12	5	200	50	69	3.0	8447
NMJ1209SAC	12	9	111	50	73	3.0	8176
NMJ1212SAC	12	12	83	50	73	3.0	7660
NMJ1215SAC	12	15	66	50	74	3.0	6950

INPUT CHARACTERISTICS

Parameter	Conditions	Min.	Typ.	Max.	Units
Voltage range	Continuous operation, 3V input types	2.97	3.3	3.63	V
	Continuous operation, 5V input types	4.5	5	5.5	
	Continuous operation, 12V input types	10.8	12	13.2	

OUTPUT CHARACTERISTICS

Parameter	Conditions	Min.	Typ.	Max.	Units
Rated Power	T _A = -40°C to 60°C, see derating graph			1	W
Voltage Set Point Accuracy	See tolerance envelopes				
Line regulation	High V _{IN} to low V _{IN}		1.0	1.2	%/%
Load regulation	10% load to rated load, xx03		10.0	15.0	%
	10% load to rated load, 0505		7.0	10.0	
	10% load to rated load, 0509, 0512, 0515		6.0	10.0	
Load regulation	10% load to rated load, 12xx		5.0	7.0	%
	10% load to rated load, 5V output types		10.0	15.0	
	10% load to rated load, 9V output types		6.0	10.0	
	10% load to rated load, 12V output types		6.0	10.0	
Zero Load Power Consumption	10% load to rated load, 15V output types		6.0	10.0	%
	All types		250		

ABSOLUTE MAXIMUM RATINGS

Lead temperature 1.5mm from case for 10 seconds	260°C
Input voltage V _{IN} , NMJ03 types	5V
Input voltage V _{IN} , NMJ05 types	7V
Input voltage V _{IN} , NMJ12 types	15V

1. Calculated using MIL-HDBK-217 FN2 calculation model with nominal input voltage at full load.
 2. See ripple & noise test method.
- All specifications typical at T_A = 25°C, nominal input voltage and rated output current unless otherwise specified.



ISOLATION CHARACTERISTICS

Parameter	Conditions	Min.	Typ.	Max.	Units
Isolation test voltage	Flash tested for 1 second	5200			VDC
Resistance	Viso= 500VDC		1		GΩ

GENERAL CHARACTERISTICS

Parameter	Conditions	Min.	Typ.	Max.	Units
Switching frequency	Single output		45		kHz
	Dual output		70		

TEMPERATURE CHARACTERISTICS

Parameter	Conditions	Min.	Typ.	Max.	Units
Specification	All output types	-40		60	°C
Storage		-55		130	
Case Temperature above ambient	All output types			33	
Cooling	Free air convection				

TEMPERATURE DERATING GRAPH

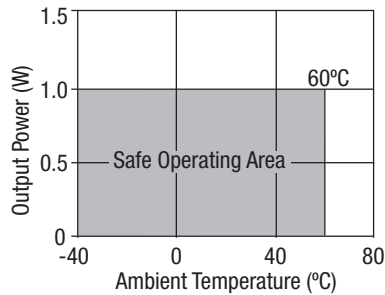

TECHNICAL NOTES

ISOLATION VOLTAGE

'Hi Pot Test', 'Flash Tested', 'Withstand Voltage', 'Proof Voltage', 'Dielectric Withstand Voltage' & 'Isolation Test Voltage' are all terms that relate to the same thing, a test voltage, applied for a specified time, across a component designed to provide electrical isolation, to verify the integrity of that isolation.

Murata Power Solutions NMJ series of DC/DC converters are all 100% production tested at their stated isolation voltage. This is 5.2kVDC for 1 second.

A question commonly asked is, "What is the continuous voltage that can be applied across the part in normal operation?"

The NMJ series has been recognized by Underwriters Laboratory to 300Vrms for Supplementary Insulation and 150Vrms for Reinforced Insulation.

REPEATED HIGH-VOLTAGE ISOLATION TESTING

It is well known that repeated high-voltage isolation testing of a barrier component can actually degrade isolation capability, to a lesser or greater degree depending on materials, construction and environment. We therefore strongly advise against repeated high voltage isolation testing, but if it is absolutely required, that the voltage be reduced by 20% from specified test voltage.

SAFETY APPROVAL

The NMJ series has been recognised by Underwriters Laboratory (UL) to UL 60950 for supplementary insulation up to 300Vrms and reinforced insulation up to 150Vrms at a maximum ambient temperature of 60°C. File number E151252 applies.

RoHS COMPLIANCE INFORMATION



This series is compatible with RoHS soldering systems with a peak wave solder temperature of 260°C for 10 seconds. The pin termination finish on this product series is Tin Plate, Hot Dipped over Matte Tin with Nickel Preplate. The series is backward compatible with Sn/Pb soldering systems.

For further information, please visit www.murata-ps.com/rohs

APPLICATION NOTES

Minimum load

The minimum load to meet datasheet specification is 10% of the full rated load across the specified input voltage range. Lower than 10% minimum loading will result in an increase in output voltage, which may rise to typically double the specified output voltage if the output load falls to less than 5%.

Capacitive loading and start up

Typical start up times for this series, with a typical input voltage rise time of 2.2µs and output capacitance of 10µF, are shown in the table below. The product series will start into a capacitance of 47µF with an increased start time, however, the maximum recommended output capacitance is 10µF.

Start-up time		Start-up time	
µs		µs	
NMJ0505SC	2530	NMJ0505SAC	1059
NMJ0509SC	7865	NMJ0509SAC	3454
NMJ0512SC	13080	NMJ0512SAC	7980
NMJ0515SC	21560	NMJ0515SAC	11505
NMJ1205SC	2770	NMJ1205SAC	1286
NMJ1209SC	20455	NMJ1209SAC	3548
NMJ1212SC	14475	NMJ1212SAC	7355
NMJ1215SC	22300	NMJ1215SAC	11535
NMJ0303SAC	530		
NMJ0503SAC	576		

Typical Start-Up Wave Form

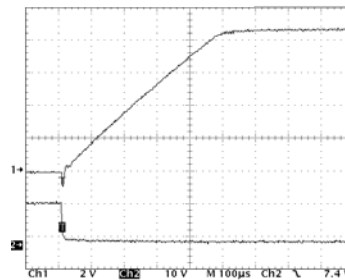

Ripple & Noise Characterisation Method

Ripple and noise measurements are performed with the following test configuration.

C1	1µF X7R multilayer ceramic capacitor, voltage rating to be a minimum of 3 times the output voltage of the DC/DC converter
C2	10µF tantalum capacitor, voltage rating to be a minimum of 1.5 times the output voltage of the DC/DC converter with an ESR of less than 100mΩ at 100 kHz
C3	100nF multilayer ceramic capacitor, general purpose
R1	450Ω resistor, carbon film, ±1% tolerance
R2	50Ω BNC termination
T1	3T of the coax cable through a ferrite toroid
RLOAD	Resistive load to the maximum power rating of the DC/DC converter. Connections should be made via twisted wires

Measured values are multiplied by 10 to obtain the specified values.

Differential Mode Noise Test Schematic

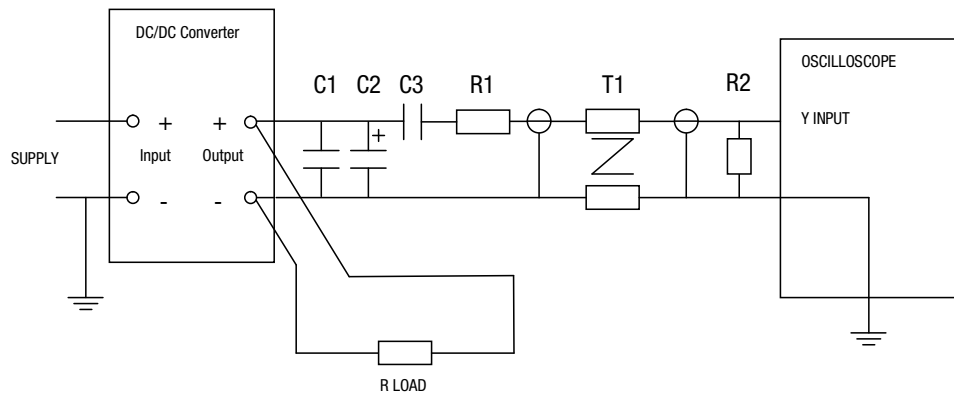

APPLICATION NOTES (continued)

Output Ripple Reduction

By using the values of inductance and capacitance stated, the output ripple at the rated load is lowered to 5mV p-p max.

Component selection

Capacitor: It is required that the ESR (Equivalent Series Resistance) should be as low as possible, ceramic types are recommended. The voltage rating should be at least twice (except for 15V output), the rated output voltage of the DC/DC converter.

Inductor: The rated current of the inductor should not be less than that of the output of the DC/DC converter. At the rated current, the DC resistance of the inductor should be such that the voltage drop across the inductor is <2% of the rated voltage of the DC/DC converter. The SRF (Self Resonant Frequency) should be >20MHz.

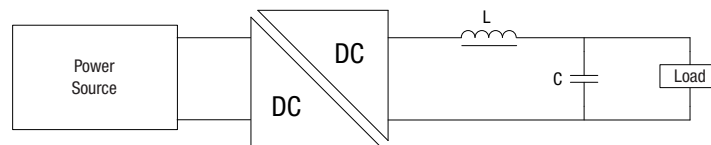

	Inductor			Capacitor
	L, μ H	Through Hole	SMD	C, μ F
3.3V single output types	22	22R223C	82223C	4.7
5V single output types	22	22R223C	82223C	4.7
9V single output types	47	22R473C	82473C	2.2
12V single output types	220	22R224C	82224C	0.47
15V single output types	220	22R224C	82224C	0.47

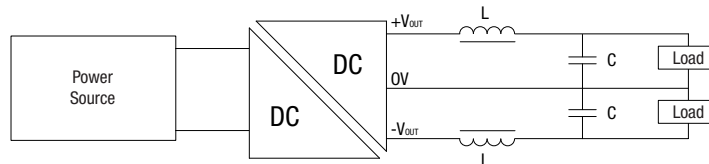

	Inductor			Capacitor
	L, μ H	Through Hole	SMD	C, μ F
5V dual output types	22	22R223C	82223C	4.70
9V dual output types	47	22R473C	82473C	2.2
12V dual output types	220	22R224C	82224C	0.47
15V dual output types	220	22R224C	82224C	0.47

TOLERANCE ENVELOPES

The voltage tolerance envelopes show typical load regulation characteristics for this product series. The tolerance envelope is the maximum output voltage variation due to changes in output loading and set point accuracy.

3.3, 5, 9, 12 & 15V output types

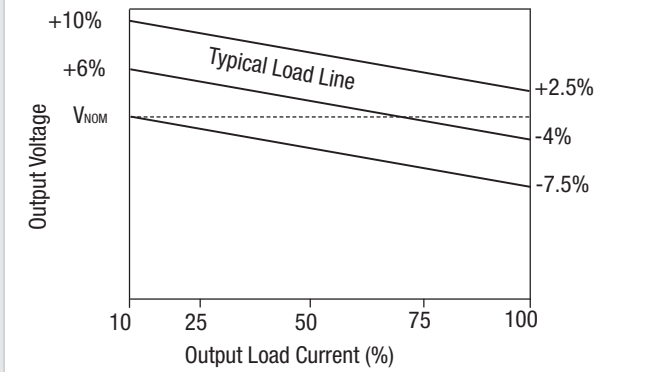

NMJ0303SAC

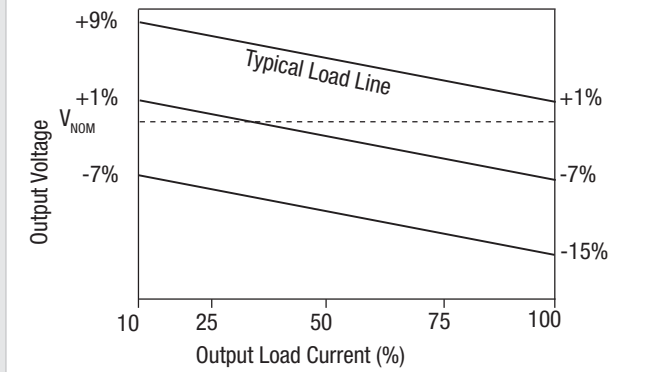

PACKAGE SPECIFICATIONS

MECHANICAL DIMENSIONS

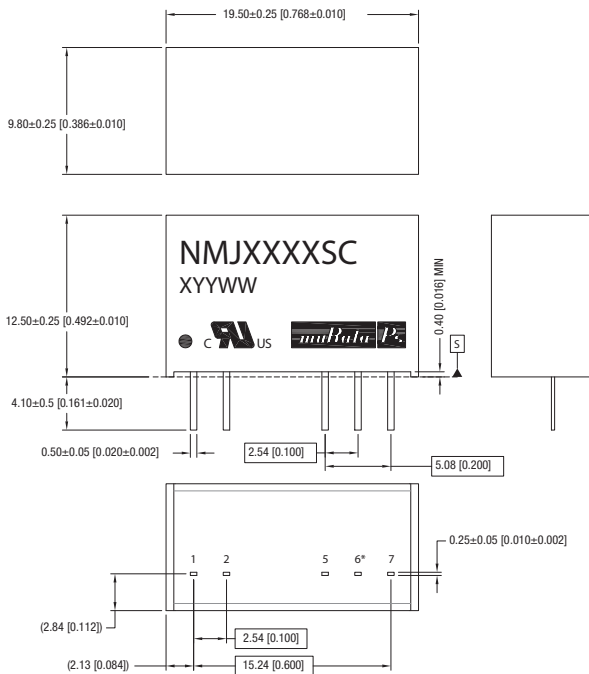

* Pin not fitted on single output variants. Weight: 4.3g
 All dimensions in mm (inches) Controlling dimension is mm.
 All pins on a 2.54 (0.100) pitch and within ±0.1 (0.004) of true position from pin 1 at seating plane 'S'

PIN CONNECTIONS

Dual Output

Pin	Function
1	+VIN
2	-VIN
5	-VOUT
6	OV
7	+VOUT

Single Output

Pin	Function
1	+VIN
2	-VIN
5	-VOUT
7	+VOUT

TUBE OUTLINE DIMENSIONS

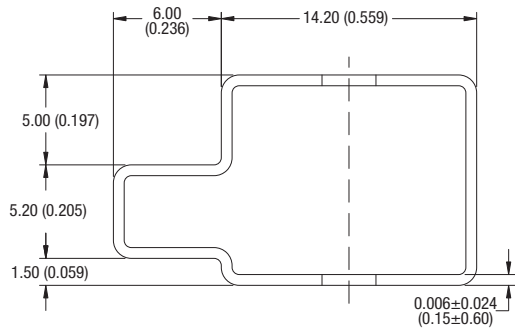

Unless otherwise stated all dimensions in mm ±0.5mm (inches ±0.02).
 Tube length : 525mm±2mm (20.669±0.079).

Tube Quantity : 25

RECOMMENDED FOOTPRINT DETAILS

Single Output Package:

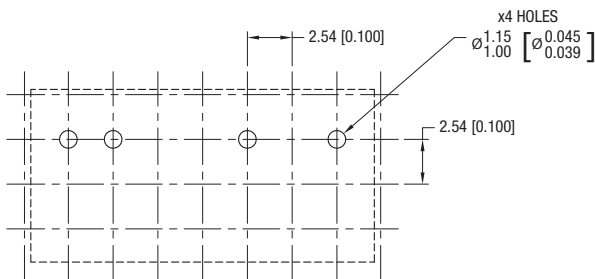

All dimensions in mm (inches) Controlling dimension is mm.

Dual Output Package:

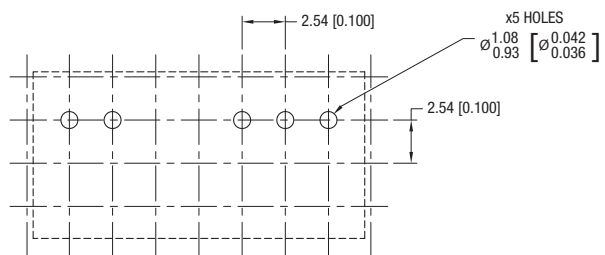

Murata Power Solutions, Inc.
 11 Cabot Boulevard, Mansfield, MA 02048-1151 U.S.A.
 ISO 9001 and 14001 REGISTERED



This product is subject to the following **operating requirements** and the **Life and Safety Critical Application Sales Policy**:
 Refer to: <http://www.murata-ps.com/requirements/>

Murata Power Solutions, Inc. makes no representation that the use of its products in the circuits described herein, or the use of other technical information contained herein, will not infringe upon existing or future patent rights. The descriptions contained herein do not imply the granting of licenses to make, use, or sell equipment constructed in accordance therewith. Specifications are subject to change without notice. © 2017 Murata Power Solutions, Inc.