

FEATURES

- 2:1 Input Voltage Range (36V – 75V, 48 Volts, nominal)
- Up to 30W output power @ 36 – 48 – 75Vin
- 89% efficiency (typical, 5Vout)
- Through-hole and optional SMT package
- Miniature 1/32 brick open frame package
- Positive & Negative Logic On/Off control option
- Over-current & Over-temperature protection
- Low output ripple and noise
- Strong thermal derating characteristics
- Operational Temperature Range –40°C to +85°C
- 1500V I/O isolation
- Tight line/load regulation
- Certified to UL/IEC 60950-1, CAN/CSA C22.2 No. 60950-1, safety approvals, 2nd Edition



PRODUCT OVERVIEW

The ULT Series isolated DC/DC converter represents the next generation converters in a 1/32 brick package. This converter is the “industry-standard” 1/32 brick form factor (0.92" x 0.75" x 0.35"). The product fully complies with RoHS-6 directive.

The thirty-second brick is offered as an open frame module; mounting options include through-hole or surface mount (SMT) pinouts. Typical applications include Optical Networking Equipment, Wireless Base Station applications, Microwave Radio communications, and Telecom and Data Equipment applications.

Modules will supply an output power of up to 30 watts over the input range of 36-75V. The ULT Series also provides a cost effective approach to highly efficient systems requiring 12V, 5V, and 3.3V voltages, eliminating the requirement for a “Bus Converter” and multiple PoL converters. The ULT family provides basic insulation with 1500Vdc isolation meeting the requirements of UL/IEC 60950. The ULT series modules are DOSA compatible industry standard 1/32 brick.

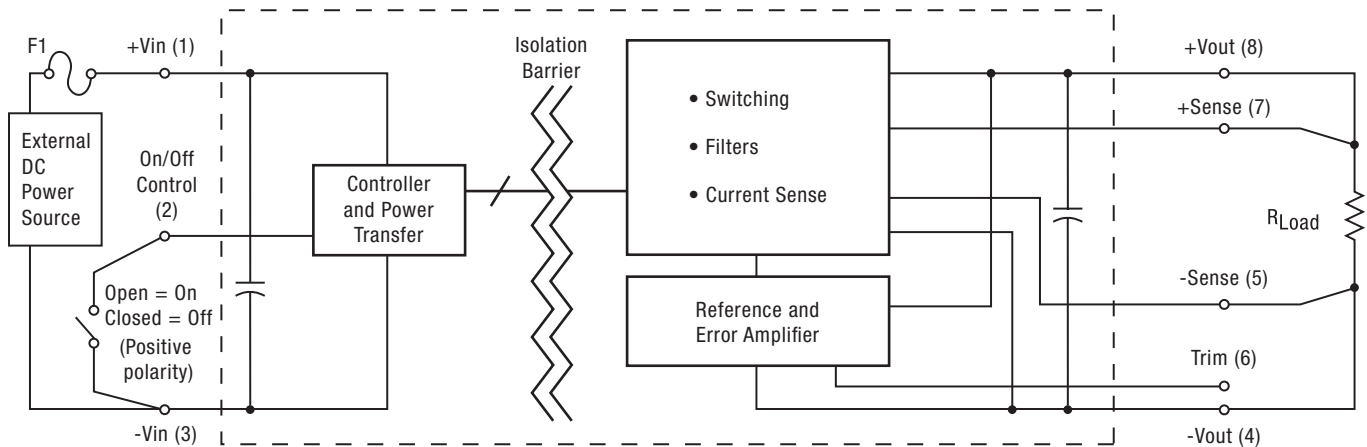

Figure 1. Connection Diagram

Typical topology is shown. Murata Power Solutions recommends an external fuse.



| PERFORMANCE SPECIFICATIONS SUMMARY AND ORDERING GUIDE ① | | | | | | | | | | | | | | |
|---|-------------------------|-------------------------------|--------------|------------------|------|---------------------|---------|-----------------------------|--------------|-----------------------------------|------------------------------------|------|---------|--------------------|
| Root Model ① | Output | | | | | | Input | | | | Efficiency | | Package | |
| | V _{OUT} (V) | I _{OUT} (A, max.) | Power (W) | R/N (mV pk-pk) ② | | Regulation (max.) ③ | | V _{IN} Nom. (V) | Range (V) | I _{IN} , no load (mA) | I _{IN} , full load (A) | Min. | Typ. | Case (inches) |
| | | | | Typ. | Max. | Line | Load | | | | | | | |
| ULT-3.3/7.5-D48 | 3.3 | 7.5 | 24.75 | 45 | 50 | ±0.15% | ±0.2% | 48 | 36-75 | 20 | 0.6 | 84% | 85.5% | 0.92 x 0.75 x 0.35 |
| ULT-5/5-D48 | 5 | 5 | 25 | 50 | 75 | ±0.1% | ±0.125% | 48 | 36-75 | 20 | 0.59 | 87% | 89% | 0.92 x 0.75 x 0.35 |
| ULT-12/2.5-D48 | 12 | 2.5 | 30 | 70 | 100 | ±0.075% | ±0.125% | 48 | 36-75 | 20 | 0.68 | 90% | 92% | 0.92 x 0.75 x 0.35 |

- ① Please refer to the Part Number Structure when ordering.
- ② All specifications are typical at nominal line voltage and full load, +25°C unless otherwise noted. See detailed specifications. External input capacitors are 33µF electrolytic and three 1µF ceramic. Output ripple is measured with 400µF capacitance across output pins for the 3.3Vout and 5Vout model. The 12Vout model

is measured with 188µF. Output caps are necessary for our test equipment and may not be needed for your application.

- ③ Regulation specifications describe output voltage deviations from a nominal/midpoint value to either extreme (50% load step).

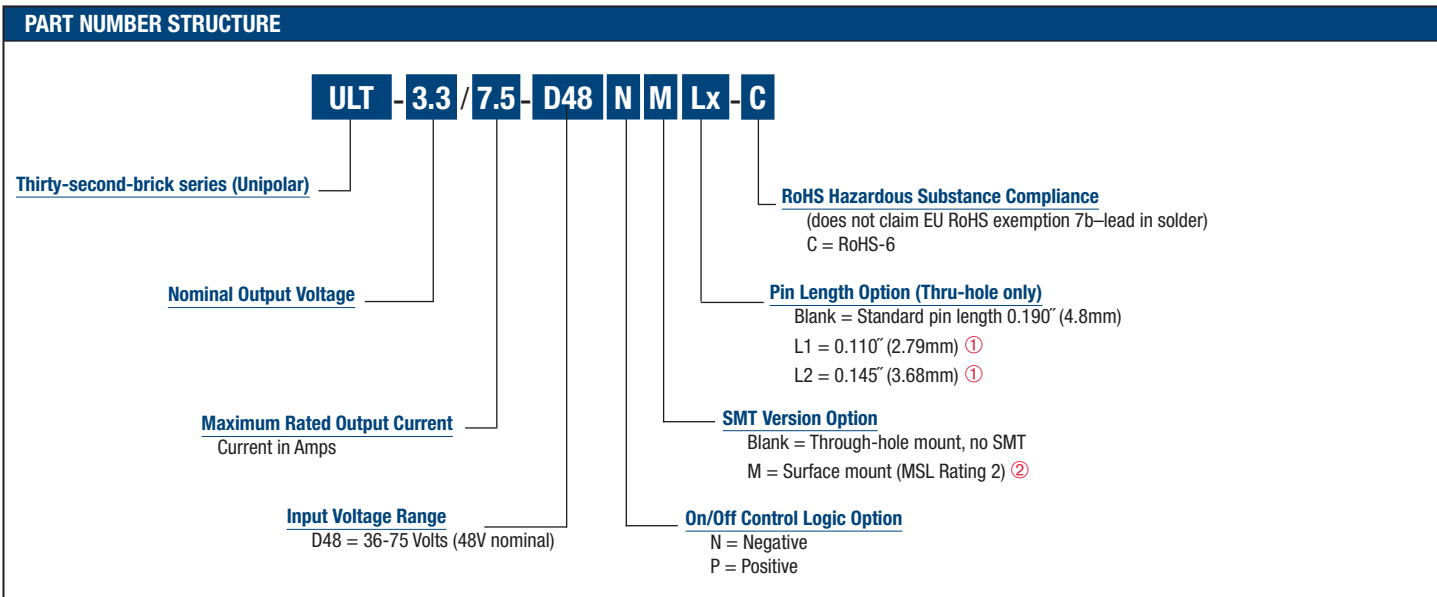

- ① **Special quantity order is required; samples available with standard pin length only.**
- ② **SMT (M) versions not available in sample quantities.**
- ③ **Some model number combinations may not be available. See website or contact your local Murata sales representative.**

FUNCTIONAL SPECIFICATIONS (ULT-3.3/7.5-D48-C)

| ABSOLUTE MAXIMUM RATINGS | Conditions ① | Minimum | Typical/Nominal | Maximum | Units |
|---|---|---------|-----------------|---------|-------------------------|
| Input Voltage, Continuous | Full temperature range | 36 | | 80 | Vdc |
| Input Voltage, Transient ⑤ | Operating or non-operating, 100 mS max. duration | | | 100 | Vdc |
| Isolation Voltage | Input to output tested | | | 1500 | Vdc |
| Input Reverse Polarity | None, install external fuse | | none | | Vdc |
| On/Off Remote Control | Power on or off, referred to -Vin | | | 15 | Vdc |
| Output Power | | | | 25 | W |
| Output Current | Current-limited, no damage, short-circuit protected | | | 7.5 | A |
| Storage Temperature Range | Vin = Zero (no power) | -40 | | 125 | °C |
| Absolute maximums are stress ratings. Exposure of devices to greater than any of these conditions may adversely affect long-term reliability. Proper operation under conditions other than those listed in the Performance/Functional Specifications Table is not implied or recommended. | | | | | |
| INPUT | | | | | |
| Conditions ① ③ | | | | | |
| Operating voltage range | | 36 | 48 | 75 | Vdc |
| Recommended External Fuse ⑬ | Fast blow | | 2 | | A |
| Start-up threshold | Rising input voltage | 32.5 | 33.3 | 34.5 | Vdc |
| Undervoltage lockout (@ ½ load) ⑪ | Falling input voltage | 30.75 | 31.75 | 32.75 | Vdc |
| Turn-On/Turn-Off Hysteresis | | 1.22 | 1.3 | 1.32 | Vdc |
| Overvoltage shutdown | Rising input voltage | | N/A | | Vdc |
| Reverse Polarity Protection | None, install external fuse | | None | | Vdc |
| Internal Filter Type | | | Capacitive | | |
| Input current | | | | | |
| Full Load Current Conditions | Vin = nominal | | 0.6 | 0.62 | A |
| Low Line Input Current | Vin = minimum | | 0.8 | 0.83 | A |
| Inrush Transient | Vin = 48V | | 0.05 | | A2-Sec. |
| Short Circuit input current | | | 0.04 | 0.1 | mA |
| No Load input current | Iout = minimum, unit=ON | | 20 | 40 | mA |
| Shut-Down Mode input current (Off, UV, OT) | | | 6 | 10 | mA |
| Reflected (back) ripple current ⑫ | Measured at input with specified filter | | 30 | | mA, pk-pk |
| GENERAL and SAFETY | | | | | |
| Efficiency | Vin=48V | 84 | 85.5 | | % |
| | Vin=36V | 83.5 | 85.5 | | % |
| Isolation | | | | | |
| Isolation Voltage, Input to Output | | | 1500 | | Vdc |
| Insulation Safety Rating | | | basic | | |
| Isolation Resistance | | 10 | | | MΩ |
| Isolation Capacitance | | | 1700 | | pF |
| Safety (certified to the following requirements) | UL-60950-1, CSA-C22.2 No.60950-1, IEC/60950-1, 2nd edition | | Yes | | |
| Calculated MTBF ④ | Per Telcordia SR332, issue 1, class 3, ground fixed, Tambient=+25°C | | TBD | | Hours x 10 ³ |
| DYNAMIC CHARACTERISTICS | | | | | |
| Fixed Switching Frequency | | 250 | 287 | 320 | KHz |
| Startup Time | Power On, to Vout regulation band, 100% | | | 50 | mS |
| Startup Time | Remote ON to Vout Regulated | | | 50 | mS |
| Dynamic Load Response | 50-75-50% load step to 1% of Vout | | 75 | 150 | µSec |
| Dynamic Load Peak Deviation | same as above | | ±100 | | mV |
| FEATURES and OPTIONS | | | | | |
| Remote On/Off Control ⑥ | | | | | |
| "N" suffix | | | | | |
| Negative Logic, ON state | ON = pin grounded or external voltage | -0.7 | | 1.0 | Vdc |
| Negative Logic, OFF state | OFF = pin open or external voltage | 10 | | 15 | Vdc |
| Control Current | open collector/drain | | 1 | | mA |
| "P" suffix | | | | | |
| Positive Logic, ON state | ON = pin open or external voltage | 10 | | 15 | V |
| Positive Logic, OFF state | OFF = ground pin or external voltage | -0.7 | | 1.0 | V |
| Control Current | open collector/drain | | 1 | | mA |

FUNCTIONAL SPECIFICATIONS (ULT-3.3/7.5-D48-C, CONT.)

| OUTPUT | Conditions ① | Minimum | Typical/Nominal | Maximum | Units |
|--|--|---------|--------------------|------------|--------------------------|
| Total Output Power | | 0 | 24.75 | 25 | W |
| Voltage | | | | | |
| Nominal Output Voltage | | 3.2505 | 3.3 | 3.35 | Vdc |
| Setting Accuracy | At 50% load | -1.5 | | 1.5 | Vdc |
| Output Trim Range ② | User selectable (see trim formulas) | -20 | | 10 | % of Vout |
| Overvoltage Protection | | 3.9 | | 4.6 | Vdc |
| Current | | | | | |
| Output Current Range | | 0 | 7.5 | 7.5 | A |
| Minimum Load | no minimal load required | | | | |
| Current Limit Inception ③ | 98% of Vnom., after warmup | 8.8 | 10.8 | 12.5 | A |
| Short Circuit | | | | | |
| Short Circuit Current | Hiccup technique, autorecovery within $\pm 1.25\%$ of Vout | | | 0.3 | A |
| Short Circuit Duration (remove short for recovery) | Output shorted to ground, no damage | | Continuous | | |
| Short circuit protection method | Hiccup current limiting | | Non-latching | | |
| Regulation ⑦ | | | | | |
| Line Regulation | Vin=min. to max., Vout=nom., full load | | | ± 0.15 | % of Vout |
| Load Regulation | Iout=min. to max., Vin=nom. | | | ± 0.2 | % of Vout |
| Ripple and Noise ⑧ | Tested with eight 47 μ F ceramic caps in parallel | | 45 | 50 | mV pk-pk |
| Temperature Coefficient | At all outputs | | 0.02 | | % of Vout./ $^{\circ}$ C |
| Maximum Capacitive Loading | Low ESR | 400 | | 5,000 | μ F |
| Remote Sense Compliance | Vsense = Vout - Vload, sense connected at load | | | 10 | % of Vout |
| MECHANICAL (Through Hole Models) | | | | | |
| | Conditions ① ③ | Minimum | Typical/Nominal | Maximum | Units |
| Outline Dimensions | | | 0.92 x 0.75 x 0.35 | | Inches |
| (Please refer to outline drawing) | LxWxH | | 23.4x19.05x8.89 | | mm |
| Weight | | | 0.32 | | Ounces |
| | | | 9.07 | | Grams |
| Through Hole Pin Diameter | | | .04 & .062 | | Inches |
| | | | 1.02 & 1.57 | | mm |
| Through Hole Pin Material | | | Brass | | |
| TH Pin Plating Metal and Thickness | Nickel subplate | | 50 | | μ -inches |
| | Gold overplate | | 3-5 | | μ -inches |
| ENVIRONMENTAL | | | | | |
| Operating Ambient Temperature Range ⑩ | See derating curves | -40 | | 85 | $^{\circ}$ C |
| Storage Temperature | Vin = Zero (no power) | -55 | | 125 | $^{\circ}$ C |
| Thermal Protection/Shutdown | | 120 | 130 | 140 | $^{\circ}$ C |
| Electromagnetic Interference Conducted, EN55022/CISPR22 | External filter is required | | | | |
| RoHS rating | | | RoHS-6 | B | Class |

Thirty-Second-Brick Isolated DC/DC Converters with 2:1 Wide Input Range

Performance Specification Notes

- ① All specifications are typical unless noted. Ambient temperature = +25°Celsius, V_{IN} is nominal, output current is maximum rated nominal. External output capacitance consists of 400 μ F capacitors across output pins; one 33 μ F low ESR, and three 1 μ F external input capacitors. All caps are low ESR.
Testing must be kept short enough that the converter does not appreciably heat up during testing. For extended testing, use plenty of airflow. See derating curves for temperature performance. All models are stable and regulate within spec without external capacitance.
- ② Input Ripple Current is tested and specified over a 5-20 MHz bandwidth and uses a special set of external filters only for the Ripple Current specifications. Input filtering is $C_{IN} = 33 \mu F$, $C_{BUS} = 220 \mu F$, $L_{BUS} = 12 \mu H$. Use capacitor rated voltages which are twice the maximum expected voltage. Capacitors must accept high speed AC switching currents.
- ③ Note that Maximum Current Derating Curves indicate an average current at nominal input voltage. At higher temperatures and/or lower airflow, the converter will tolerate brief full current outputs if the average RMS current over time does not exceed the Derating curve. All Derating curves are presented at sea level altitude. Be aware of reduced power dissipation with increasing density altitude.
- ④ Mean Time Before Failure (MTBF) is calculated using the Telcordia (Bellcore) SR-332 Method 1, Case 3, Issue 1, ground fixed conditions. Operating temperature = +25°C, full output load, natural air convection.
- ⑤ The output may be shorted to ground indefinitely with no damage. The Output Short Circuit Current shown in the specifications is an average consisting of very short bursts of full rated current to test whether the output circuit can be repowered.
- ⑥ The On/Off pin allows the converter to be turned on or off by an external device such as a switch, a transistor, a logic gate, or an optical isolator. If the "logic pin" is left floating the measured voltage will be outside the limit's in the data sheet. Those numbers define the levels needed for the "control function" to take place and do not represent the voltage that may be present on the logic pin.
- ⑦ Regulation specifications describe the deviation as the input line voltage or output load current is varied from a nominal midpoint value to either extreme (50% load).
- ⑧ Do not exceed maximum power ratings, sense limits or output overvoltage when adjusting output trim values.
- ⑨ Output overload protection is non-latching. When the output overload is removed, the output will automatically recover.
- ⑩ All models are fully operational and meet published specifications, including "cold start" at -40°C.
- ⑪ The converter will shut off if the input falls below the undervoltage threshold. It will not restart until the input exceeds the Input Start Up Voltage.
- ⑫ Output noise may be further reduced by installing an external filter. See the Application Notes. Use only as much output filtering as needed ***and no more***. Larger caps (especially low-ESR ceramic types) may slow transient response or degrade dynamic performance. Thoroughly test your application with all components installed.
- ⑬ If reverse polarity is accidentally applied to the input, always connect an external fast blow input fuse in series with the + V_{IN} input.
- ⑭ Although extremely unlikely, failure of the internal components of this product may expose external application circuits to dangerous voltages, currents, temperatures or power levels. Please thoroughly verify all applications before committing them to service. Be sure to include appropriately rated FUSES (see specifications and Application Notes) to reduce the risk of failure.
- ⑮ Special care should be exercised so that Input Voltage Transient does not exceed specified Max 100V/100ms. At normal input a large transient spike can be generated as a result of distribution inductance and high inrush current charging input cap on converter. This can be eliminated with 33 μ F electrolytic capacitor mounted close to Converter input. The series resistance (500m Ω < ESR < 700m Ω) is essential in this solution.

TYPICAL PERFORMANCE DATA, ULT-3.3/7.5-D48-C

Efficiency vs. Line Voltage and Load Current @ 25°C

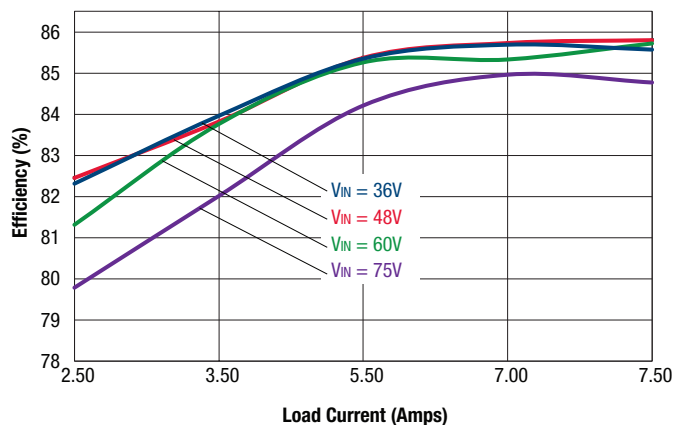

Power Dissipation @ 25°C

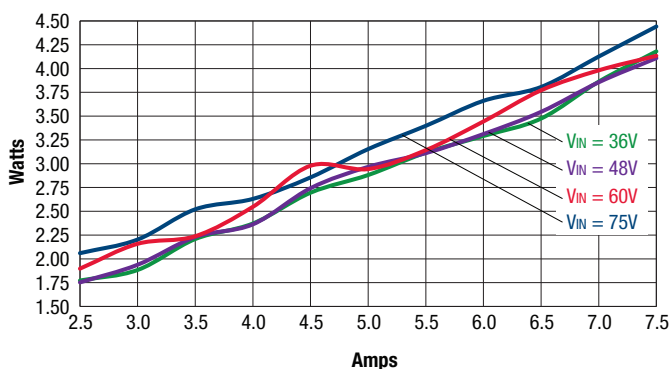

Maximum Current Temperature Derating at sea level
VIN = 36V (air flow from Pin 3 to Pin 1 on PCB)

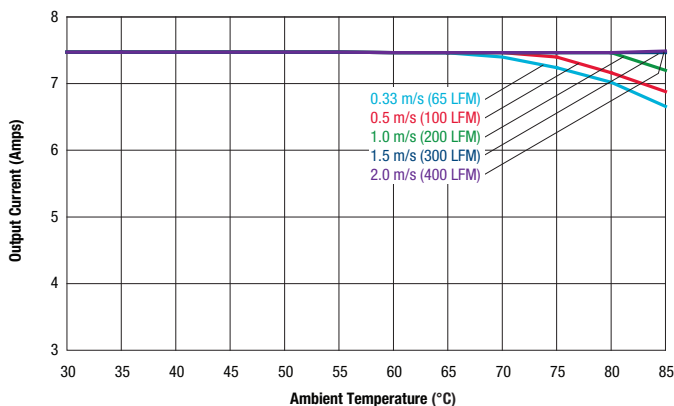

Maximum Current Temperature Derating at sea level
VIN = 48V (air flow from Pin 3 to Pin 1 on PCB)

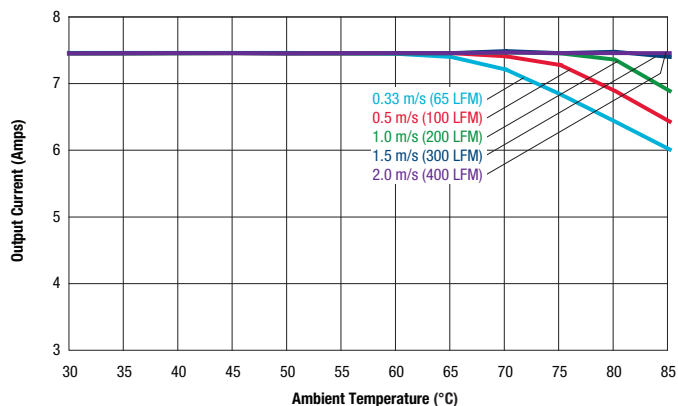

Maximum Current Temperature Derating at sea level
VIN = 60V (air flow from Pin 3 to Pin 1 on PCB)

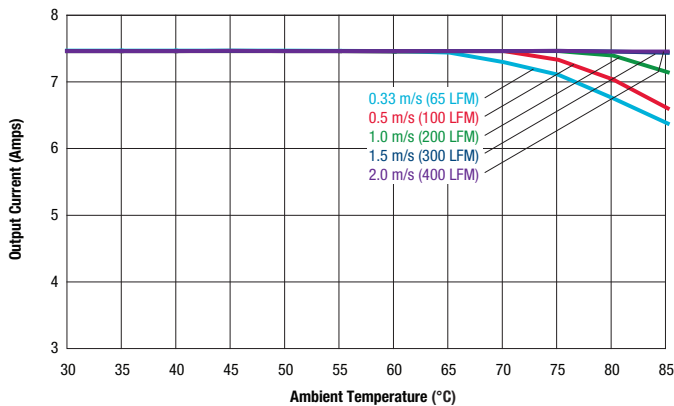

Maximum Current Temperature Derating at sea level
VIN = 75V (air flow from Pin 3 to Pin 1 on PCB)

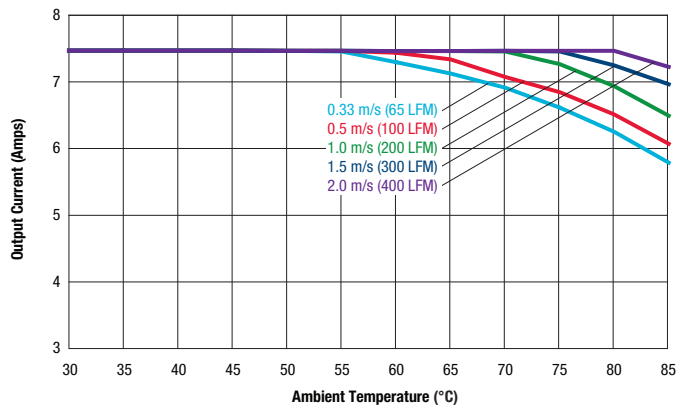

TYPICAL PERFORMANCE DATA, ULT-3.3/7.5-D48-C

On/Off Enable Delay Startup (Vin=48V, Vout=3.3V, Iout=7.5A, Cload=400uF, Ta=+25°C) Ch1=Enable, Ch4=Vout

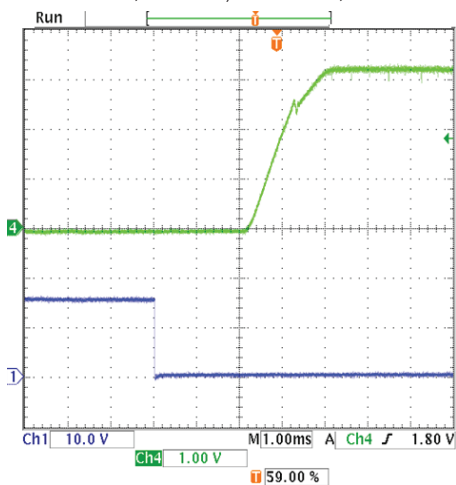

Vin Startup Delay (Vin=48V, Vout=3.3V, Iout=7.5A, Cload=400uF, Ta=+25°C) Ch1=Vin, Ch4=Vout

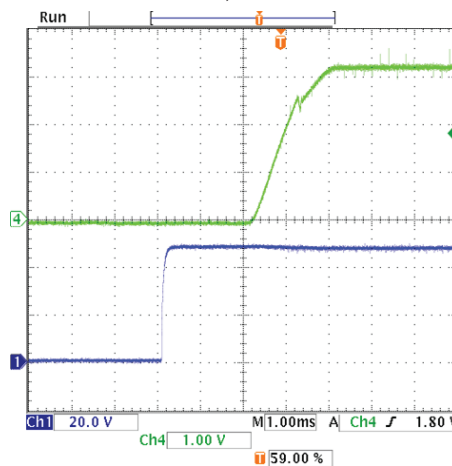

Output Ripple and Noise (Vin=48V, Iout=7.5A, Cload=0, 4x100uF caps, Ta=+25°C, ScopeBW=20Mhz)

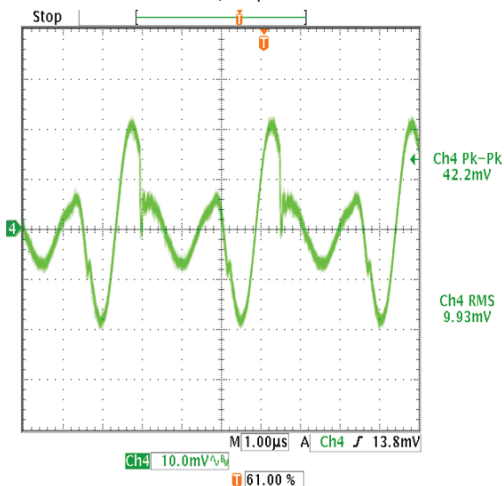

Output Ripple and Noise (Vin=48V, Iout=0A, Cload=0, 4x100uF caps, Ta=+25°C, ScopeBW=20Mhz)

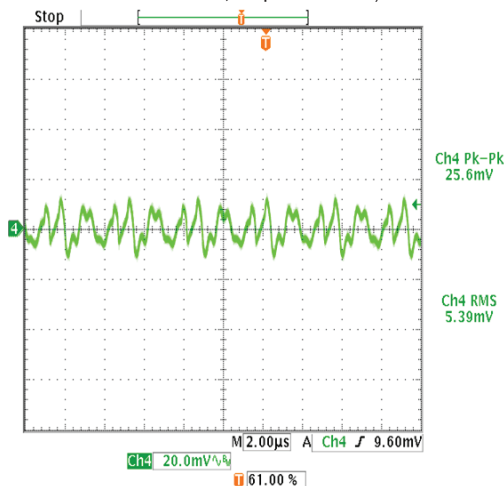

Stepload Transient Response (Vin=48V, Iout=50-75-50% of Imax, Cload=4x100uF, Ta=+25°C)

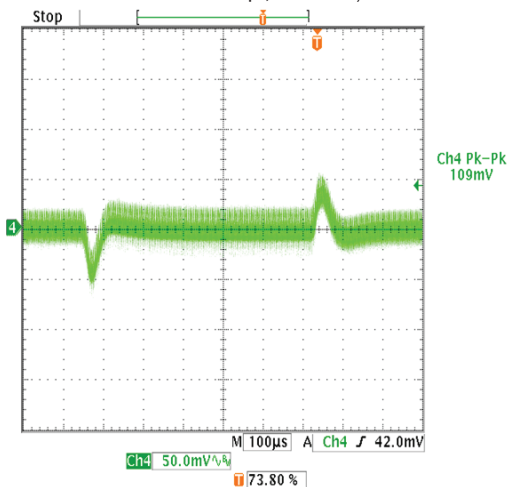

Thermal image with hot spot at full load current with 25°C ambient temperature. Natural convection is used with no forced airflow. Identifiable and recommended maximum value to be verified in application. Vin=48V, Q8 max Temp=104°C.

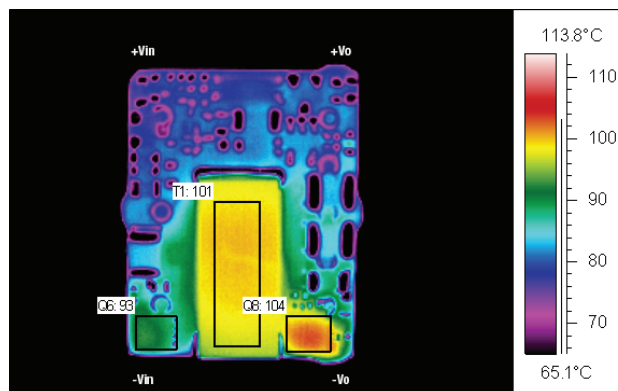

FUNCTIONAL SPECIFICATIONS (ULT-5/5-D48-C)

| ABSOLUTE MAXIMUM RATINGS | Conditions ① | Minimum | Typical/Nominal | Maximum | Units |
|---|---|----------------|-----------------|---------|-------------------------|
| Input Voltage, Continuous | Full temperature range | 36 | | 80 | Vdc |
| Input Voltage, Transient ⑤ | Operating or non-operating, 100 mS max. duration | | | 100 | Vdc |
| Isolation Voltage | Input to output tested | | | 1500 | Vdc |
| Input Reverse Polarity | None, install external fuse | | none | | Vdc |
| On/Off Remote Control | Power on or off, referred to -Vin | 0 | | 15 | Vdc |
| Output Power | | 0 | | 25.25 | W |
| Output Current | Current-limited, no damage, short-circuit protected | 0 | | 5 | A |
| Storage Temperature Range | Vin = Zero (no power) | -55 | | 125 | °C |
| Absolute maximums are stress ratings. Exposure of devices to greater than any of these conditions may adversely affect long-term reliability. Proper operation under conditions other than those listed in the Performance/Functional Specifications Table is not implied or recommended. | | | | | |
| INPUT | | Conditions ① ③ | | | |
| Operating voltage range | | 36 | 48 | 75 | Vdc |
| Recommended External Fuse | Fast blow | | 2 | | A |
| Start-up threshold ② | Rising input voltage | 32 | 33.25 | 34.25 | Vdc |
| Undervoltage lockout (@ ½ load) ① | Falling input voltage | 30.8 | 32.5 | 34 | Vdc |
| Turn-On/Turn-Off Hysteresis | | 1.03 | 1.31 | 1.61 | Vdc |
| Overvoltage shutdown | Rising input voltage | | N/A | | Vdc |
| Reverse Polarity Protection | None, install external fuse | | N/A | | Vdc |
| Internal Filter Type | | | Capacitive | | |
| Input current | | | | | |
| Full Load Conditions | Vin = nominal | | 0.59 | 0.6 | A |
| Low Line | Vin = minimum | | 0.79 | 0.81 | A |
| Inrush Transient | | | 0.05 | | A2-Sec. |
| Short Circuit input current | | | 50 | 100 | mA |
| No Load input current | Iout = minimum, unit=ON | | 20 | 40 | mA |
| Shut-Down Mode input current (Off, UV, OT) | | | 1 | 3 | mA |
| Reflected (back) ripple current ② | Measured at input with specified filter | | 15 | 30 | mA, pk-pk |
| GENERAL and SAFETY | | | | | |
| Efficiency | Vin=48V | 87 | 89 | | % |
| | Vin=36V | 87 | 88.5 | | % |
| Isolation | | | | | |
| Isolation Voltage, Input to Output | | | 1500 | | Vdc |
| Isolation Voltage | | | | | Vdc |
| Insulation Safety Rating | | | basic | | |
| Isolation Resistance | | 10 | | | MΩ |
| Isolation Capacitance | | | 1650 | | pF |
| Safety | UL-60950-1, CSA-C22.2 No.60950-1, IEC/60950-1, 2nd edition | | Yes | | |
| Calculated MTBF ④ | Per Telcordia SR332, issue 1, class 3, ground fixed, Tambient=+25°C | | 7.3 | | Hours x 10 ⁶ |
| DYNAMIC CHARACTERISTICS | | | | | |
| Fixed Switching Frequency | | 225 | 255 | 285 | KHz |
| Startup Time | Power On, to Vout regulation band, 100% | | 5 | 10 | mS |
| Startup Time | Remote ON to Vout Regulated | | 5 | 10 | mS |
| Dynamic Load Response | 50-75-50% load step to 1% error band | | 75 | 150 | μSec |
| Dynamic Load Peak Deviation | same as above | | ±150 | | mV |
| FEATURES and OPTIONS | | | | | |
| Remote On/Off Control ⑥ | | | | | |
| "N" suffix | | | | | |
| Negative Logic, ON state | ON = pin grounded or external voltage | -0.7 | | 1.2 | Vdc |
| Negative Logic, OFF state | OFF = pin open or external voltage | 10 | | 15 | Vdc |
| Control Current | open collector/drain | | 1 | | mA |
| "P" suffix | | | | | |
| Positive Logic, ON state | ON = pin open or external voltage | 10 | | 15 | V |
| Positive Logic, OFF state | OFF = ground pin or external voltage | -0.7 | | 1.2 | V |
| Control Current | open collector/drain | | 1 | | mA |

FUNCTIONAL SPECIFICATIONS (ULT-5/5-D48-C, CONT.)

| OUTPUT | Conditions ① | Minimum | Typical/Nominal | Maximum | Units |
|--|---|----------------|------------------------|----------------|---------------|
| Total Output Power | | 0 | 25 | 25.25 | W |
| Voltage | | | | | |
| Nominal Output Voltage | | 4.925 | 5 | 5.075 | Vdc |
| Setting Accuracy | At 50% load | -1.5 | | 1.5 | % of Vo nom |
| Output Trim Range ③ | User selectable (see trim formulas) | -20 | | 10 | % of Vout |
| Overvoltage Protection | | 6 | 6.6 | 7.2 | Vdc |
| Current | | | | | |
| Output Current Range | | 0 | 5 | 5 | A |
| Minimum Load | | | | | |
| Current Limit Inception ⑨ | 98% of Vnom., after warmup | 5.5 | 7 | 8.4 | A |
| Short Circuit | | | | | |
| Short Circuit Current | Hiccup technique, autorecovery within $\pm 1.25\%$ of Vout | | | 0.3 | A |
| Short Circuit Duration (remove short for recovery) | Output shorted to ground, no damage | | Continuous | | |
| Short circuit protection method | Hiccup current limiting | | Non-latching | | |
| Regulation ⑦ | | | | | |
| Line Regulation | Vin=min. to max., Vout=nom., full load | | | ± 0.1 | % of Vout |
| Load Regulation | Iout=min. to max., Vin=nom. | | | ± 0.125 | % of Vout |
| Ripple and Noise ⑩ | Tested with eight 47 μ F ceramic caps in parallel | | 50 | 75 | mV pk-pk |
| Temperature Coefficient | At all outputs | | 0.02 | | % of Vout./°C |
| Maximum Capacitive Loading | Low ESR | 400 | | 5,000 | μ F |
| Remote Sense Compliance | Vsense = Vout - Vload, sense connected at load | | | 10 | % of Vout |
| MECHANICAL (Through Hole Models) | | | | | |
| | Conditions ① ③ | Minimum | Typical/Nominal | Maximum | Units |
| Outline Dimensions | | | 0.92 x 0.75 x 0.35 | | Inches |
| (Please refer to outline drawing) | LxWxH | | 23.4x19.05x8.89 | | mm |
| Weight | | | 0.32 | | Ounces |
| | | | 9.07 | | Grams |
| Through Hole Pin Diameter | | | .04 & .062 | | Inches |
| | | | 1.02 & 1.57 | | mm |
| Through Hole Pin Material | | | Brass | | |
| TH Pin Plating Metal and Thickness | Nickel subplate | | 50 | | μ -inches |
| | Gold overplate | | 3-5 | | μ -inches |
| ENVIRONMENTAL | | | | | |
| Operating Ambient Temperature Range ⑩ | No Derating, full power, Natural convection, Vertical mount. See derating curves. | -40 | | 85 | °C |
| Storage Temperature | Vin = Zero (no power) | -55 | | 125 | °C |
| Thermal Protection/Shutdown | | 120 | 130 | 140 | °C |
| Electromagnetic Interference Conducted, EN55022/CISPR22 | External filter is required | | | B | Class |
| RoHS rating | | | RoHS-6 | | |

Thirty-Second-Brick Isolated DC/DC Converters with 2:1 Wide Input Range

Performance Specification Notes

- ① All specifications are typical unless noted. Ambient temperature = +25°Celsius, V_{IN} is nominal, output current is maximum rated nominal. External output capacitance consists of 400 μ F capacitors across output pins; one 33 μ F low ESR, and three 1 μ F external input capacitors. All caps are low ESR.
Testing must be kept short enough that the converter does not appreciably heat up during testing. For extended testing, use plenty of airflow. See derating curves for temperature performance. All models are stable and regulate within spec without external capacitance.
- ② Input Ripple Current is tested and specified over a 5-20 MHz bandwidth and uses a special set of external filters only for the Ripple Current specifications. Input filtering is $C_{IN} = 33 \mu F$, $C_{BUS} = 220 \mu F$, $L_{BUS} = 12 \mu H$. Use capacitor rated voltages which are twice the maximum expected voltage. Capacitors must accept high speed AC switching currents.
- ③ Note that Maximum Current Derating Curves indicate an average current at nominal input voltage. At higher temperatures and/or lower airflow, the converter will tolerate brief full current outputs if the average RMS current over time does not exceed the Derating curve. All Derating curves are presented at sea level altitude. Be aware of reduced power dissipation with increasing density altitude.
- ④ Mean Time Before Failure (MTBF) is calculated using the Telcordia (Bellcore) SR-332 Method 1, Case 3, Issue 1, ground fixed conditions. Operating temperature = +25°C, full output load, natural air convection.
- ⑤ The output may be shorted to ground indefinitely with no damage. The Output Short Circuit Current shown in the specifications is an average consisting of very short bursts of full rated current to test whether the output circuit can be repowered.
- ⑥ The On/Off pin allows the converter to be turned on or off by an external device such as a switch, a transistor, a logic gate, or an optical isolator. If the "logic pin" is left floating the measured voltage will be outside the limit's in the data sheet. Those numbers define the levels needed for the "control function" to take place and do not represent the voltage that may be present on the logic pin.
- ⑦ Regulation specifications describe the deviation as the input line voltage or output load current is varied from a nominal midpoint value to either extreme (50% load).
- ⑧ Do not exceed maximum power ratings, sense limits or output overvoltage when adjusting output trim values.
- ⑨ Output overload protection is non-latching. When the output overload is removed, the output will automatically recover.
- ⑩ All models are fully operational and meet published specifications, including "cold start" at -40°C.
- ⑪ The converter will shut off if the input falls below the undervoltage threshold. It will not restart until the input exceeds the Input Start Up Voltage.
- ⑫ Output noise may be further reduced by installing an external filter. See the Application Notes. Use only as much output filtering as needed ***and no more***. Larger caps (especially low-ESR ceramic types) may slow transient response or degrade dynamic performance. Thoroughly test your application with all components installed.
- ⑬ If reverse polarity is accidentally applied to the input, always connect an external fast blow input fuse in series with the + V_{IN} input.
- ⑭ Although extremely unlikely, failure of the internal components of this product may expose external application circuits to dangerous voltages, currents, temperatures or power levels. Please thoroughly verify all applications before committing them to service. Be sure to include appropriately rated FUSES (see specifications and Application Notes) to reduce the risk of failure.
- ⑮ Special care should be exercised so that Input Voltage Transient does not exceed specified Max 100V/100ms. At normal input a large transient spike can be generated as a result of distribution inductance and high inrush current charging input cap on converter. This can be eliminated with 33 μ F electrolytic capacitor mounted close to Converter input. The series resistance (500m Ω < ESR < 700m Ω) is essential in this solution.

TYPICAL PERFORMANCE DATA, ULT-5/5-D48

Efficiency vs. Line Voltage and Load Current @ 25°C

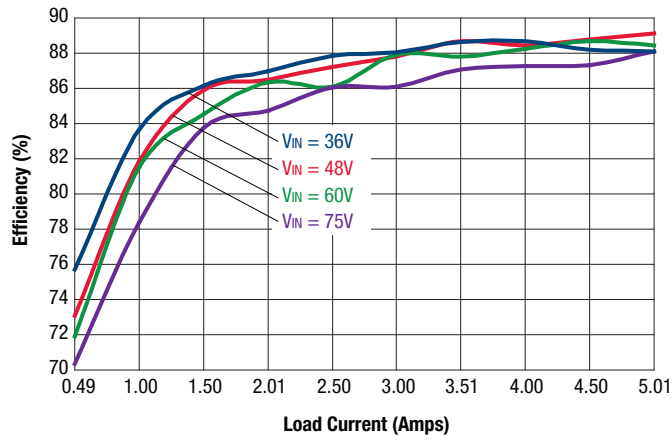

Current Limit

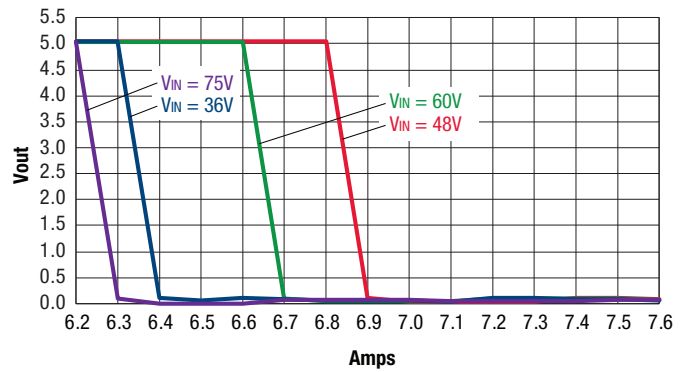

Power Dissipation @ 25°C

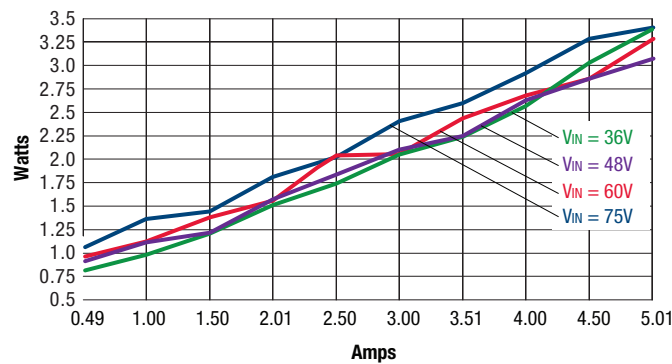

Maximum Current Temperature Derating at sea level
VIN = 36-75V (air flow from Pin 3 to Pin 1 on PCB)

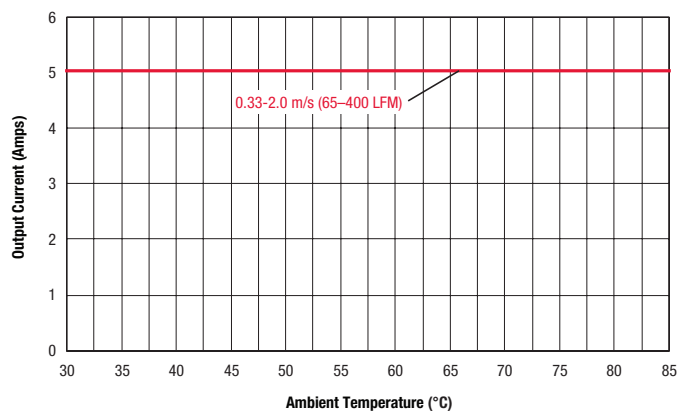

TYPICAL PERFORMANCE DATA, ULT-5/5-D48

On/Off Enable Delay (Vin=48V, Vout=nom, Iout=5A, Cload=400uF, Ta=+25°C, ScopeBW=20Mhz) Ch1=Enable, Ch4=Vout

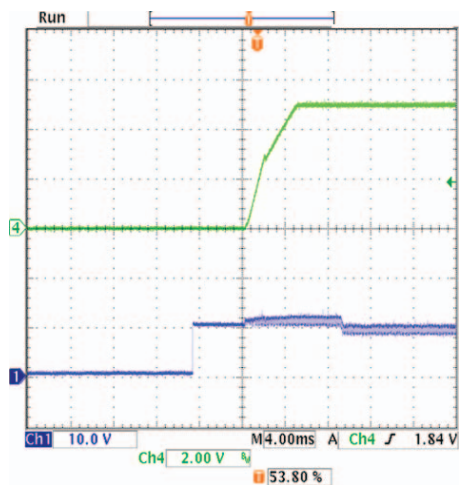

Vin Startup Delay (Vin=48V, Vout=5V, Iout=5A, Cload=400uF, Ta=+25°C) Ch1=Vin, Ch4=Vout

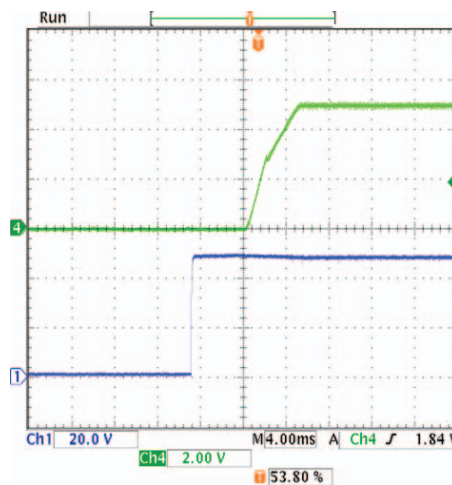

Stepload Transient Response (Vin=48V, Iout=50-75-50% of Imax, Cload=4x100uF, Ta=+25°C)

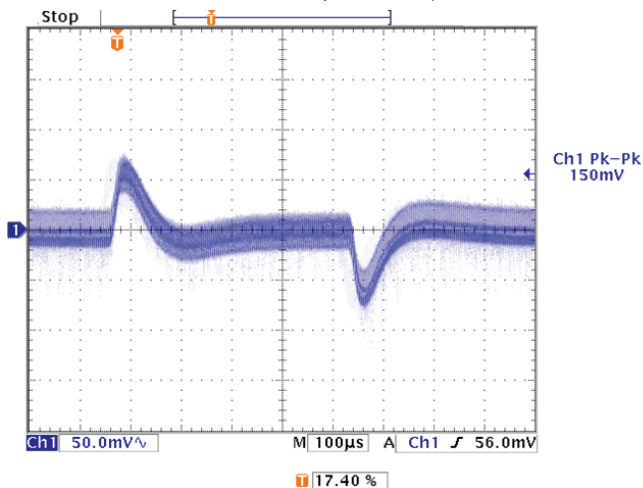

Output Ripple and Noise (Vin=48V, Iout=5A, Cload=0, 4x100uF caps, Ta=+25°C, ScopeBW=20Mhz)

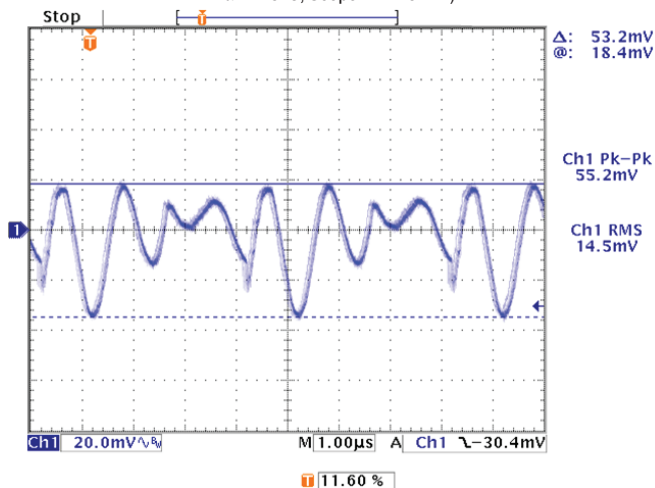

Thermal image with hot spot at full load current with 25 °C ambient temperature. Natural convection is used with no forced airflow. Identifiable and recommended maximum value to be verified in application. Vin=48V, Q8 max Temp=96°C.

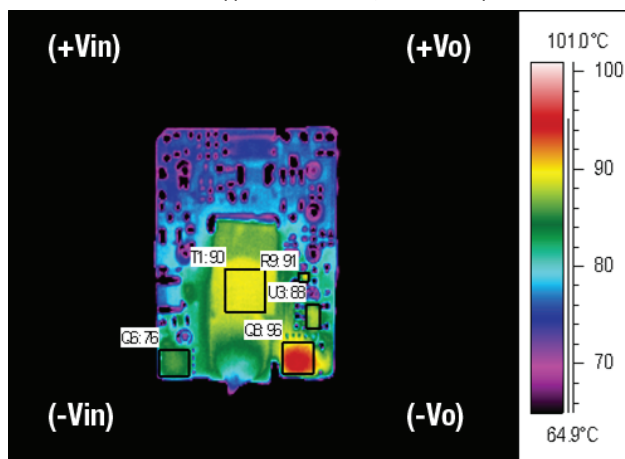

FUNCTIONAL SPECIFICATIONS (ULT-12/2.5-D48-C)

| ABSOLUTE MAXIMUM RATINGS | Conditions ① | Minimum | Typical/Nominal | Maximum | Units |
|---|---|---------|-----------------|---------|-------------------------|
| Input Voltage, Continuous | Full temperature range | 36 | | 80 | Vdc |
| Input Voltage, Transient ⑤ | Operating or non-operating, 100 mS max. duration | | | 100 | Vdc |
| Isolation Voltage | Input to output tested | | | 1500 | Vdc |
| Input Reverse Polarity | None, install external fuse | | none | | Vdc |
| On/Off Remote Control | Power on or off, referred to -Vin | 0 | | 15 | Vdc |
| Output Power | | 0 | | 30.3 | W |
| Output Current | Current-limited, no damage, short-circuit protected | 0 | | 2.5 | A |
| Storage Temperature Range | Vin = Zero (no power) | -40 | | 125 | °C |
| Absolute maximums are stress ratings. Exposure of devices to greater than any of these conditions may adversely affect long-term reliability. Proper operation under conditions other than those listed in the Performance/Functional Specifications Table is not implied or recommended. | | | | | |
| INPUT | | | | | |
| Conditions ① ③ | | | | | |
| Operating voltage range | | 36 | 48 | 75 | Vdc |
| Recommended External Fuse | Fast blow | | | 2 | A |
| Start-up threshold ② | Rising input voltage | 32 | 33 | 34 | Vdc |
| Undervoltage lockout (@ ½ load) ① | Falling input voltage | 30.75 | 31.8 | 33 | Vdc |
| Overvoltage shutdown | Rising input voltage | | N/A | | Vdc |
| Turn-On/Turn-Off Hysteresis | | 1.3 | 1.31 | 1.32 | Vdc |
| Reverse Polarity Protection | None, install external fuse | | None | | Vdc |
| Internal Filter Type | | | Capacitive | | |
| Input current | | | | | |
| Full Load Current Conditions | Vin = nominal | | 0.68 | 0.70 | A |
| Low Line Input Current | Vin = minimum | | 0.92 | 0.95 | A |
| Inrush Transient | Vin = 48V. | | 0.05 | | A2-Sec. |
| Short Circuit Input Current. | | | 0.05 | 0.1 | mA |
| No Load Input Current | Iout = minimum, unit=ON | | 20 | 40 | mA |
| Shutdown Mode Input Current (Off, UV, OT) | | | 1 | 3 | mA |
| Reflected (back) ripple current ② | Measured at input with specified filter | | 30 | | mA, pk-pk |
| GENERAL and SAFETY | | | | | |
| Efficiency | Vin=48V | 90 | 92 | | % |
| | Vin=36V | 89 | 91 | | % |
| Isolation | | | | | |
| Isolation Voltage, Input to Output | | 1500 | | | Vdc |
| Insulation Safety Rating | | | basic | | |
| Isolation Resistance | | | 100 | | MΩ |
| Isolation Capacitance | | | 1600 | | pF |
| Safety | UL-60950-1, CSA-C22.2 No.60950-1, IEC/60950-1, 2nd edition | | Yes | | |
| Calculated MTBF ④ | Per Telcordia SR332, issue 1, class 3, ground fixed, Tambient=+25°C | | TBD | | Hours x 10 ⁶ |
| DYNAMIC CHARACTERISTICS | | | | | |
| Fixed Switching Frequency | | 270 | 300 | 330 | KHz |
| Startup Time | Power On, to Vout regulation band, 100% resistive load | | 6 | 30 | mS |
| Startup Time | Remote ON to Vout Regulated | | 12 | 30 | mS |
| Dynamic Load Response | 50-75-50% load step to 1% error band | | 100 | 150 | μSec |
| Dynamic Load Peak Deviation | same as above | | ±150 | ±250 | mV |
| FEATURES and OPTIONS | | | | | |
| Remote On/Off Control ⑥ | | | | | |
| "N" suffix | | | | | |
| Negative Logic, ON state | ON = pin grounded or external voltage | -0.7 | | 0.9 | Vdc |
| Negative Logic, OFF state | OFF = pin open or external voltage | 10 | | 15 | Vdc |
| Control Current | open collector/drain | | 1 | | mA |
| "P" suffix | | | | | |
| Positive Logic, ON state | ON = pin open or external voltage | 10 | | 15 | V |
| Positive Logic, OFF state | OFF = ground pin or external voltage | -0.7 | | 0.9 | V |
| Control Current | open collector/drain | | 1 | | mA |

FUNCTIONAL SPECIFICATIONS (ULT-12/2.5-D48-C, CONT.)

| OUTPUT | Conditions ① | Minimum | Typical/Nominal | Maximum | Units |
|--|--|---------|--------------------|---------|---------------|
| Total Output Power | | 0 | 30 | 30.3 | W |
| Voltage | | | | | |
| Nominal Output Voltage | | 11.88 | 12 | 12.12 | Vdc |
| Setting Accuracy | At 50% load | -1 | | 1 | % of Vo nom |
| Output Trim Range ③ | User selectable (see trim formulas) | -20 | | 10 | % of Vout |
| Overvoltage Protection | | 13.3 | 15 | 18 | Vdc |
| Current | | | | | |
| Output Current Range | | 0 | 2.5 | 2.5 | A |
| Minimum Load | no minimal load required | | | | |
| Current Limit Inception ⑨ | 98% of Vnom., after warmup | 2.65 | 3.55 | 4.3 | A |
| Short Circuit | | | | | |
| Short Circuit Current | Hiccup technique, autorecovery within ±1.25% of Vout | | 0.4 | | A |
| Short Circuit Duration (remove short for recovery) | Output shorted to ground, no damage | | Continuous | | |
| Short circuit protection method | Hiccup current limiting | | Non-latching | | |
| Regulation ⑦ | | | | | |
| Line Regulation | Vin=min. to max., Vout=nom., full load | | | ±0.075 | % of Vout |
| Load Regulation | Iout=min. to max., Vin=nom. | | | ±0.125 | % of Vout |
| Ripple and Noise ⑩ | Tested with 4x47uF output caps. | | 70 | 100 | mV pk-pk |
| Temperature Coefficient | At all outputs | | 0.02 | | % of Vout./°C |
| Maximum Capacitive Loading | Full resistive load, low ESR | 200 | | 2,200 | µF |
| Remote Sense Compliance | Vsense = Vout - Vload, sense connected at load | | | 10 | % of Vout |
| MECHANICAL (Through Hole Models) | | | | | |
| | Conditions ① ③ | Minimum | Typical/Nominal | Maximum | Units |
| Outline Dimensions | | | 0.92 x 0.75 x 0.35 | | Inches |
| (Please refer to outline drawing) | LxWxH | | 23.4x19.05x8.89 | | mm |
| Weight | | | 0.32 | | Ounces |
| | | | 9.07 | | Grams |
| Through Hole Pin Diameter | | | .04 & .062 | | Inches |
| | | | 1.02 & 1.57 | | mm |
| Through Hole Pin Material | | | Brass | | |
| TH Pin Plating Metal and Thickness | Nickel subplate | | 50 | | µ-inches |
| | Gold overplate | | 3-5 | | µ-inches |
| ENVIRONMENTAL | | | | | |
| Operating Ambient Temperature Range ⑩ | See derating curves | -40 | | 85 | °C |
| Storage Temperature | Vin = Zero (no power) | -55 | | 125 | °C |
| Thermal Protection/Shutdown | | 120 | 130 | 140 | °C |
| Electromagnetic Interference Conducted, EN55022/CISPR22 | External filter is required | | | B | Class |
| RoHS rating | | | RoHS-6 | | |

Thirty-Second-Brick Isolated DC/DC Converters with 2:1 Wide Input Range

Performance Specification Notes

- ① All specifications are typical unless noted. Ambient temperature = +25°Celsius, V_{IN} is nominal, output current is maximum rated nominal. External output capacitance consists of 400 μ F capacitors across output pins; one 33 μ F low ESR, and three 1 μ F external input capacitors. All caps are low ESR.
Testing must be kept short enough that the converter does not appreciably heat up during testing. For extended testing, use plenty of airflow. See derating curves for temperature performance. All models are stable and regulate within spec without external capacitance.
- ② Input Ripple Current is tested and specified over a 5-20 MHz bandwidth and uses a special set of external filters only for the Ripple Current specifications. Input filtering is $C_{IN} = 33 \mu F$, $C_{BUS} = 220 \mu F$, $L_{BUS} = 12 \mu H$. Use capacitor rated voltages which are twice the maximum expected voltage. Capacitors must accept high speed AC switching currents.
- ③ Note that Maximum Current Derating Curves indicate an average current at nominal input voltage. At higher temperatures and/or lower airflow, the converter will tolerate brief full current outputs if the average RMS current over time does not exceed the Derating curve. All Derating curves are presented at sea level altitude. Be aware of reduced power dissipation with increasing density altitude.
- ④ Mean Time Before Failure (MTBF) is calculated using the Telcordia (Bellcore) SR-332 Method 1, Case 3, Issue 1, ground fixed conditions. Operating temperature = +25°C, full output load, natural air convection.
- ⑤ The output may be shorted to ground indefinitely with no damage. The Output Short Circuit Current shown in the specifications is an average consisting of very short bursts of full rated current to test whether the output circuit can be repowered.
- ⑥ The On/Off pin allows the converter to be turned on or off by an external device such as a switch, a transistor, a logic gate, or an optical isolator. If the "logic pin" is left floating the measured voltage will be outside the limit's in the data sheet. Those numbers define the levels needed for the "control function" to take place and do not represent the voltage that may be present on the logic pin.
- ⑦ Regulation specifications describe the deviation as the input line voltage or output load current is varied from a nominal midpoint value to either extreme (50% load).
- ⑧ Do not exceed maximum power ratings, sense limits or output overvoltage when adjusting output trim values.
- ⑨ Output overload protection is non-latching. When the output overload is removed, the output will automatically recover.
- ⑩ All models are fully operational and meet published specifications, including "cold start" at -40°C.
- ⑪ The converter will shut off if the input falls below the undervoltage threshold. It will not restart until the input exceeds the Input Start Up Voltage.
- ⑫ Output noise may be further reduced by installing an external filter. See the Application Notes. Use only as much output filtering as needed ***and no more***. Larger caps (especially low-ESR ceramic types) may slow transient response or degrade dynamic performance. Thoroughly test your application with all components installed.
- ⑬ If reverse polarity is accidentally applied to the input, always connect an external fast blow input fuse in series with the + V_{IN} input.
- ⑭ Although extremely unlikely, failure of the internal components of this product may expose external application circuits to dangerous voltages, currents, temperatures or power levels. Please thoroughly verify all applications before committing them to service. Be sure to include appropriately rated FUSES (see specifications and Application Notes) to reduce the risk of failure.
- ⑮ Special care should be exercised so that Input Voltage Transient does not exceed specified Max 100V/100ms. At normal input a large transient spike can be generated as a result of distribution inductance and high inrush current charging input cap on converter. This can be eliminated with 33 μ F electrolytic capacitor mounted close to Converter input. The series resistance (500m Ω < ESR < 700m Ω) is essential in this solution.

TYPICAL PERFORMANCE DATA, ULT-12/2.5-D48

Efficiency vs. Line Voltage and Load Current @ 25°C

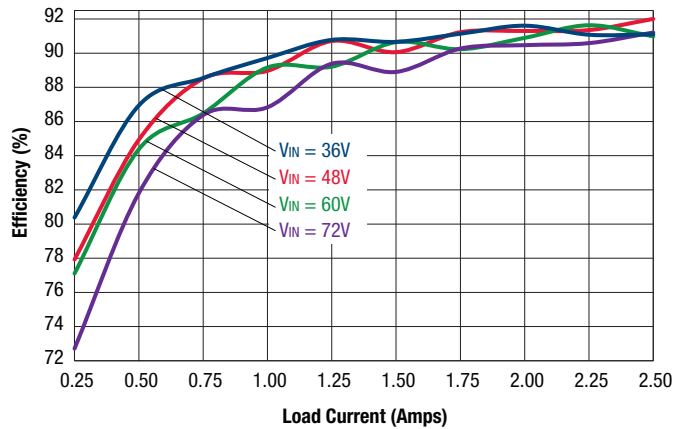

Power Dissipation @ 25°C

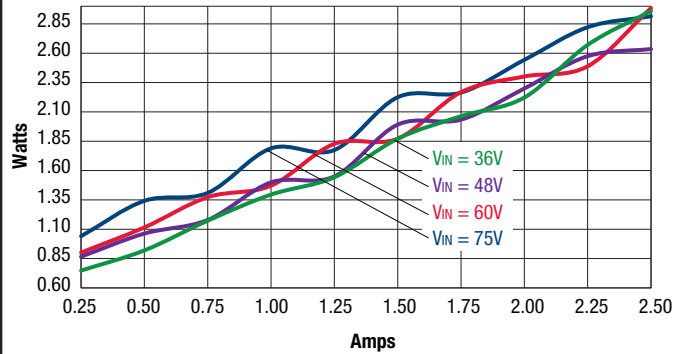

Maximum Current Temperature Derating at sea level
V_{in} = 36-48V (air flow from Pin 3 to Pin 1 on PCB)

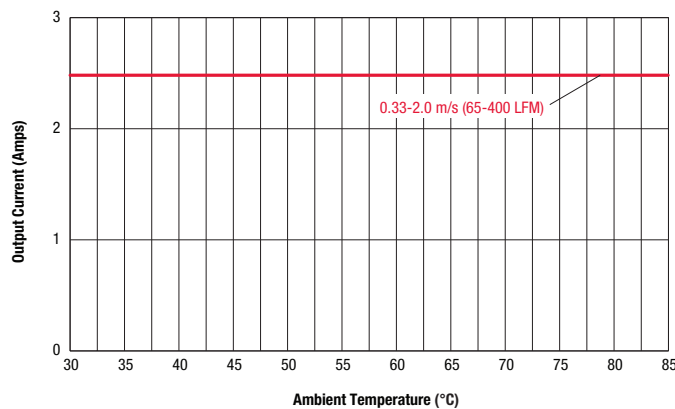

Maximum Current Temperature Derating at sea level
V_{in} = 60V (air flow from Pin 3 to Pin 1 on PCB)

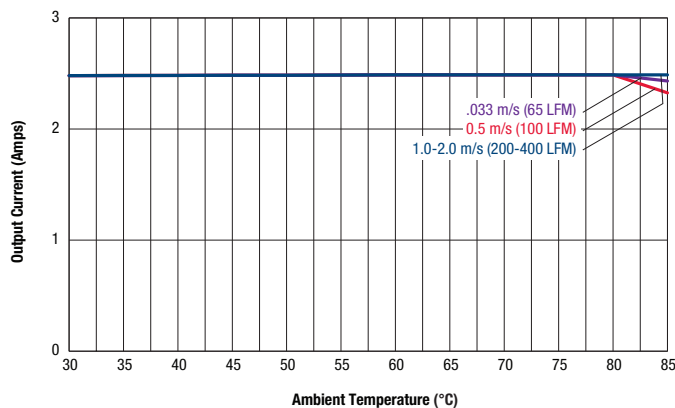

Maximum Current Temperature Derating at sea level
V_{in} = 75V (air flow from Pin 3 to Pin 1 on PCB)

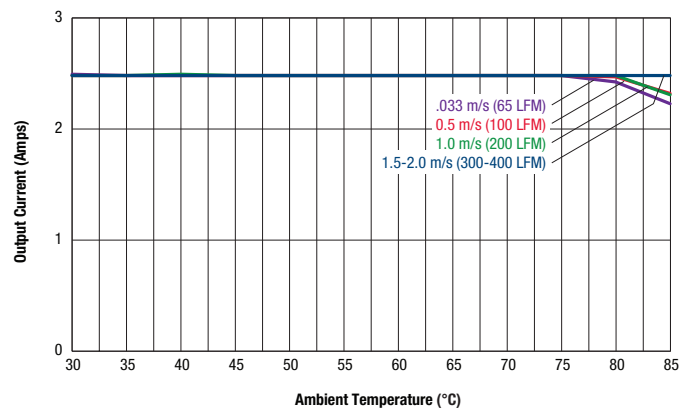

TYPICAL PERFORMANCE DATA, ULT-12/2.5-D48

On/Off Enable Delay Startup (Vin=48V, Vout=12V, Iout=2.5A, Cload=188uF, Ta=+25°C)
Ch1=Enable, Ch4=Vout

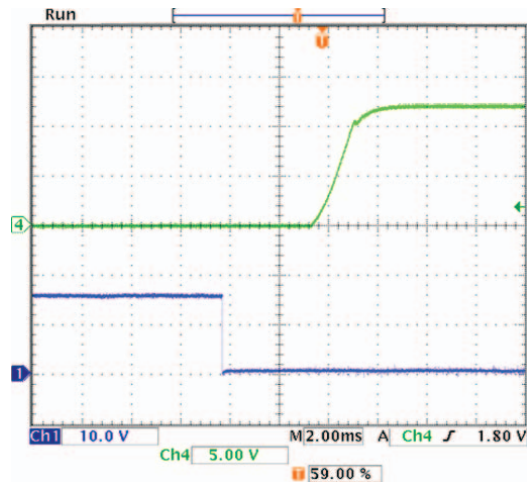

Vin Startup Delay (Vin=48V, Vout=12V, Iout=2.5A, Cload=188uF, Ta=+25°C)
Ch1=Vin, Ch4=Vout

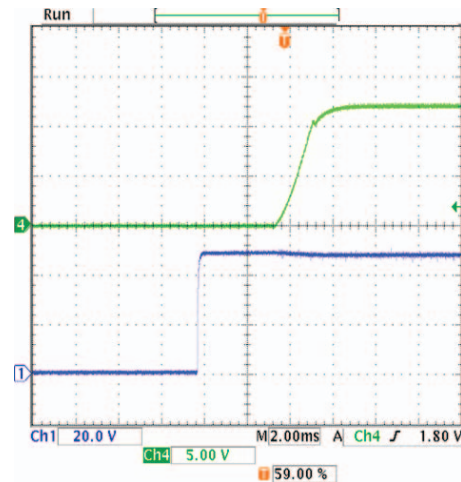

Stepload Transient Response (Vin=48V, Iout=50-75-50 of Imax, Cload=4x47uF, Ta=+25°C)

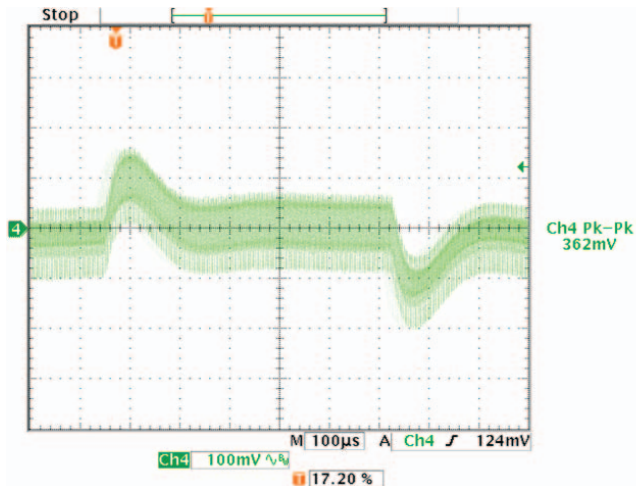

Output Ripple and Noise (Vin=48V, Iout=2.5A, Cload=4 (47 uF caps), Ta=+25°C, ScopeBW=20Mhz)

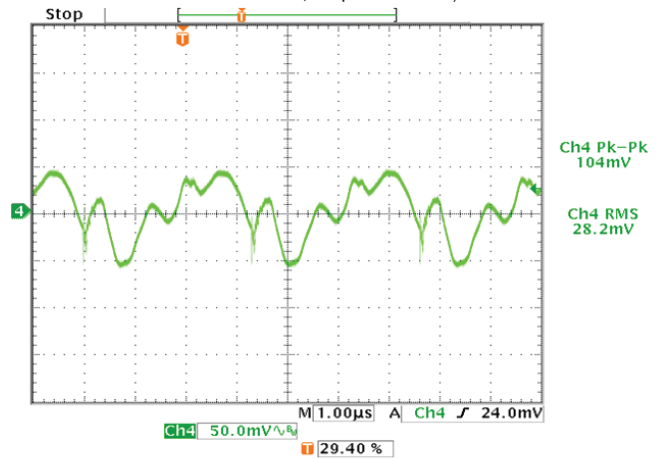

Startup Delay (Vin=48V, Iout=2.5A, Cload=188uF, Ta=+25°C) Ch1=Vin, Ch2=Vout

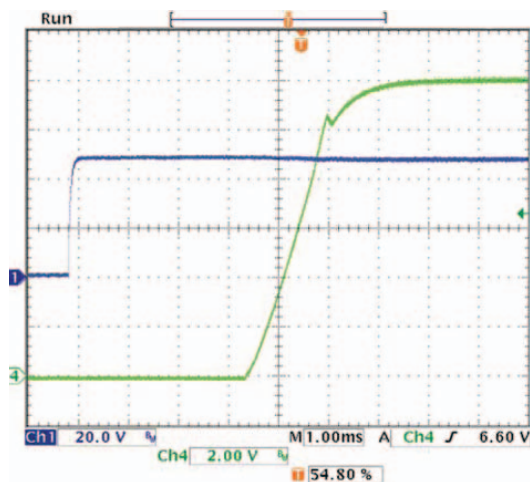

Thermal image with hot spot at full load current with +25°C ambient temperature. Natural convection is used with no forced airflow. Identifiable and recommended maximum value to be verified in application. Vin=48V, T1 max Temp=83°C.

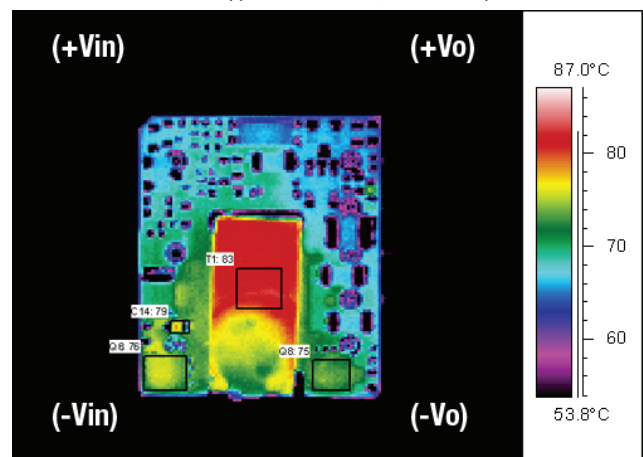

MECHANICAL SPECIFICATIONS, THROUGH-HOLE MOUNT

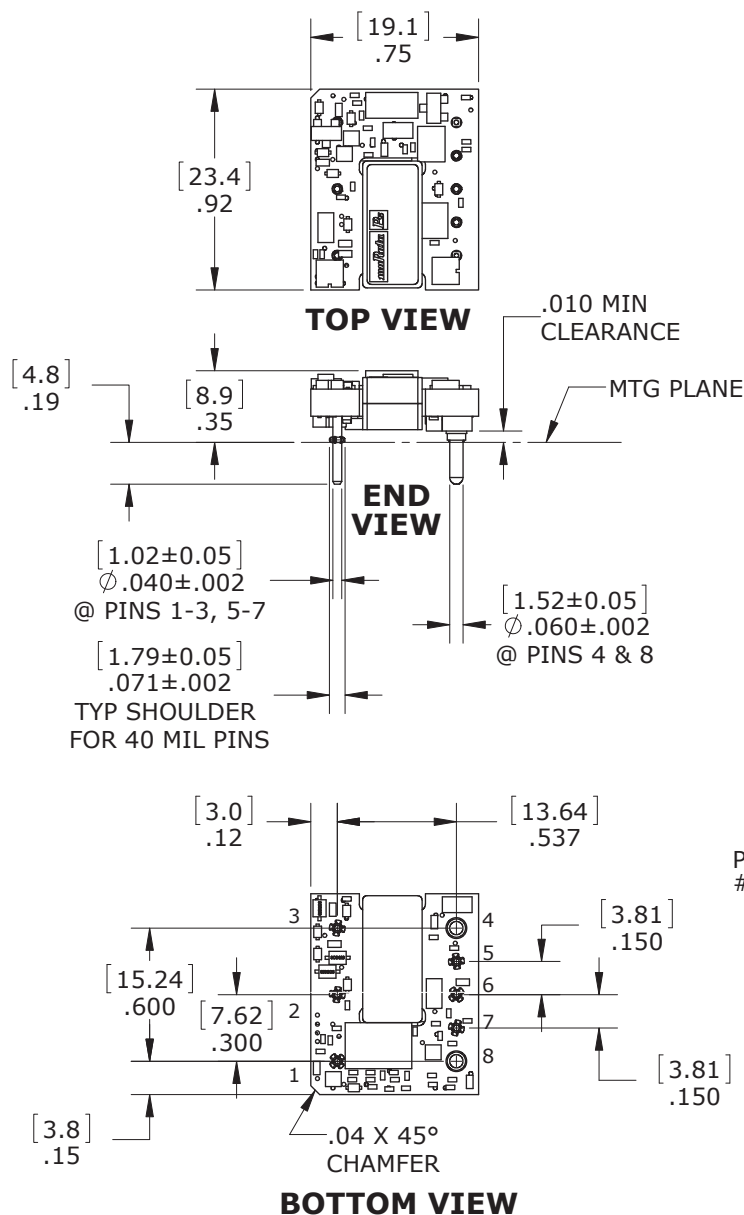

Important! **Always** connect the sense pins. If they are not connected to a remote load, wire each sense pin to its respective voltage output at the converter pins.

The 0.19-inch pin length is shown. Please refer to the part number structure for alternate pin lengths.
Pin material: Brass.

Finish (all pins):
Gold (3-5 μ -inches min)
Over Nickel (50 μ -inches min)

Please note that some competitive units may use different pin numbering or alternate outline views; however, all units are plugin-compatible.

ISOMETRIC VIEW

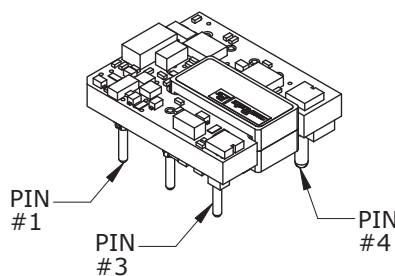

| INPUT/OUTPUT CONNECTIONS | | | |
|--------------------------|----------------|-----|----------|
| Pin | Function | Pin | Function |
| 3 | -Vin | 4 | -Vout |
| | | 5 | -Sense |
| 2 | On/Off Control | 6 | Trim |
| | | 7 | +Sense |
| 1 | +Vin | 8 | +Vout |

Dimensions are in inches (mm) shown for ref. only.

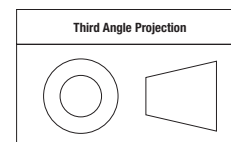

Tolerances (unless otherwise specified):
.XX ± 0.02 (0.5)
.XXX ± 0.010 (0.25)
Angles ± 2°

Components are shown for reference only and may vary between units.

DIMENSIONS ARE IN INCHES [mm]

TOLERANCES:
2 PLACE ±.02 ANGLES: ±1°
3 PLACE ±.010

COMPONENTS SHOWN ARE FOR REFERENCE ONLY

MATERIAL:
 ϕ .040 PINS: COPPER ALLOY
 ϕ .060 PINS: COPPER ALLOY

FINISH: (ALL PINS)
GOLD (5 μ "MIN) OVER NICKEL (50 μ " MIN)

MECHANICAL SPECIFICATIONS, SURFACE MOUNT

TOP VIEW

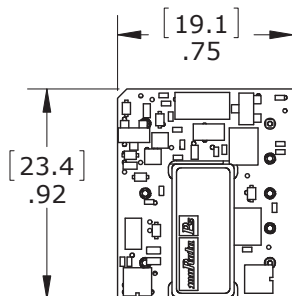

Important! **Always** connect the sense pins. If they are not connected to a remote load, wire each sense pin to its respective voltage output at the converter pins.

Pin material: Brass.
Finish (all pins):
Gold (3-5 μ-inches min)
Over Nickel (50 μ-inches min)
Please note that some competitive units may use different pin numbering or alternate outline views; however, all units are plugin-compatible.

Coplanarity spec: 0.004" [0.1mm]

END VIEW

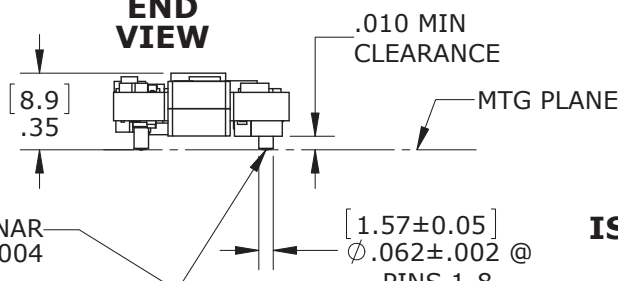

ALL PINS COPLANAR WITHIN .004

ISOMETRIC VIEW

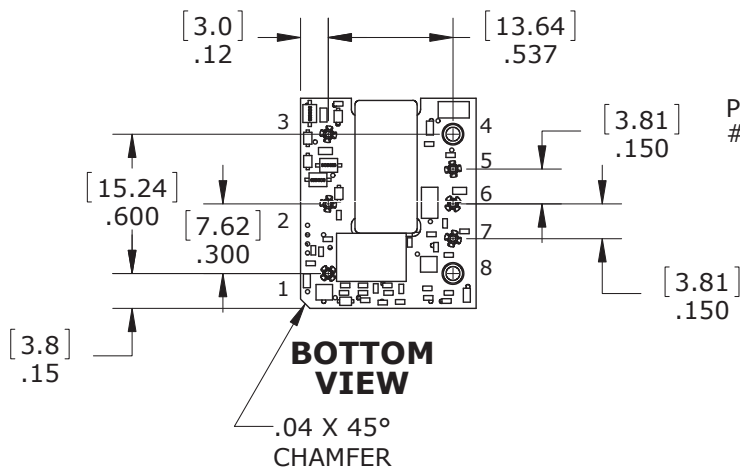
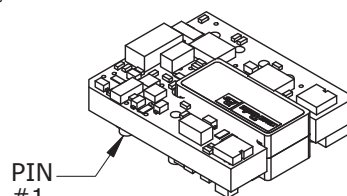

| INPUT/OUTPUT CONNECTIONS | | | |
|--------------------------|----------------|-----|----------|
| Pin | Function | Pin | Function |
| 3 | -Vin | 4 | -Vout |
| | | 5 | -Sense |
| 2 | On/Off Control | 6 | Trim |
| | | 7 | +Sense |
| 1 | +Vin | 8 | +Vout |

Dimensions are in inches (mm) shown for ref. only.

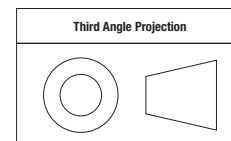

Tolerances (unless otherwise specified):
.XX ± 0.02 (0.5)
.XXX ± 0.010 (0.25)
Angles ± 2°

Components are shown for reference only and may vary between units.

DIMENSIONS ARE IN INCHES [mm]

TOLERANCES:
2 PLACE ±.02 ANGLES: ±1°
3 PLACE ±.010

COMPONENTS SHOWN ARE FOR REFERENCE ONLY

MATERIAL:
SMT PINS: COPPER ALLOY

FINISH: (ALL PINS)
GOLD (5μ"MIN) OVER NICKEL (50μ" MIN)

RECOMMENDED FOOTPRINT, THROUGH-HOLE (VIEW THROUGH CONVERTER)

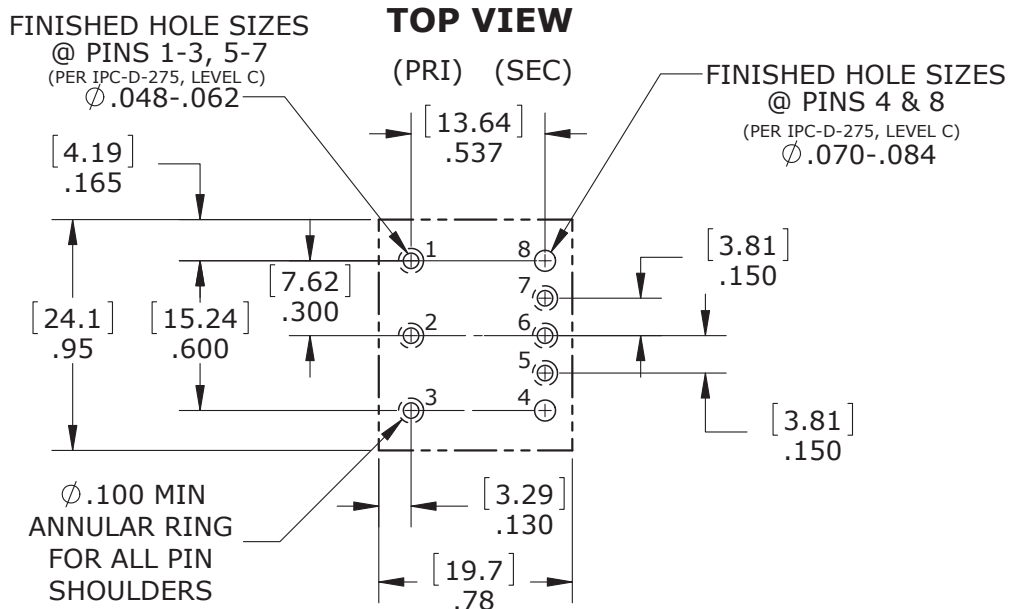

IT IS RECOMMENDED THAT NO PARTS
BE PLACED BENEATH CONVERTER

RECOMMENDED FOOTPRINT, SURFACE MOUNT (VIEW THROUGH CONVERTER)

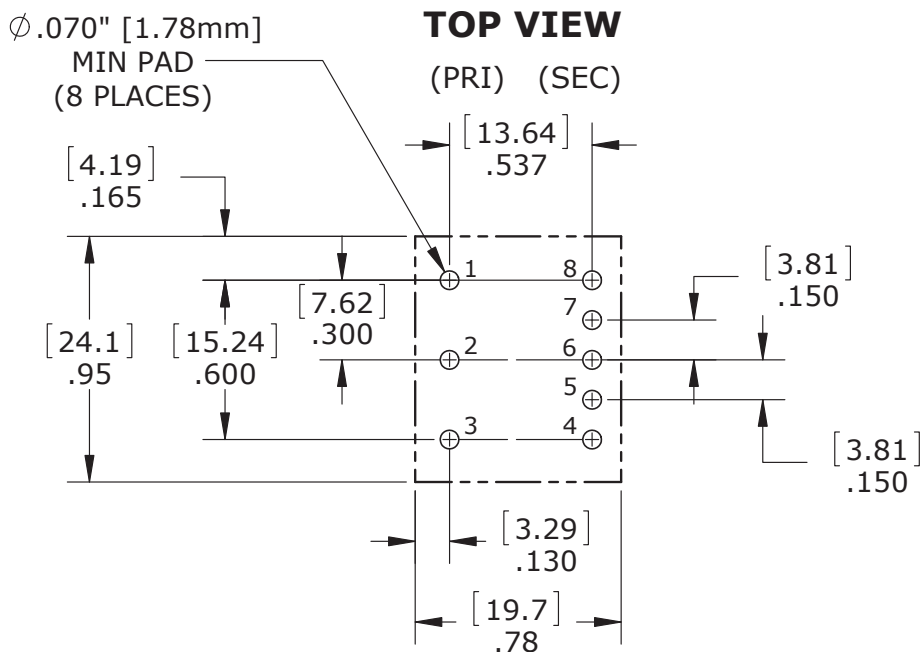

IT IS RECOMMENDED THAT NO PARTS
BE PLACED BENEATH CONVERTER

Dimensions are in inches (mm) shown for ref. only.

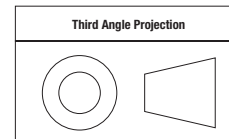

Tolerances (unless otherwise specified):
.XX ± 0.02 (0.5)
.XXX ± 0.010 (0.25)
Angles $\pm 2^\circ$

Components are shown for reference only
and may vary between units.

SHIPPING TRAYS AND BOXES, THROUGH-HOLE MOUNT

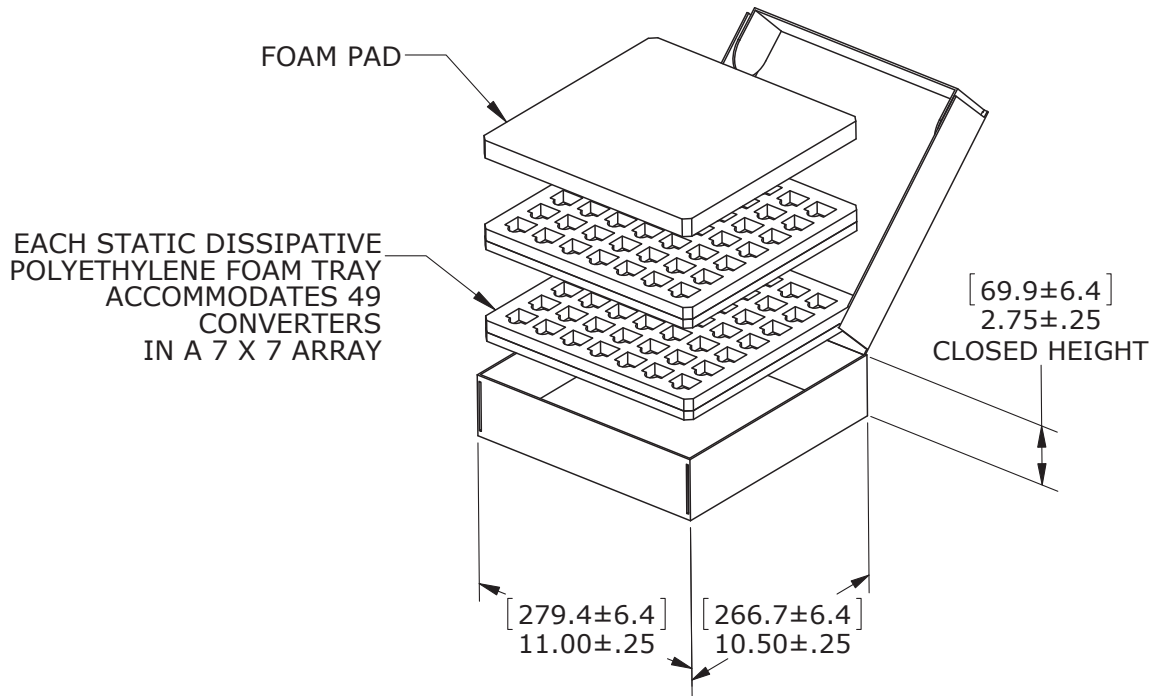

49 UNITS PER TRAY
2 TRAYS PER CARTON

MPQ=98 UNITS

TAPE AND REEL INFORMATION, SURFACE MOUNT (MSL RATING 2)

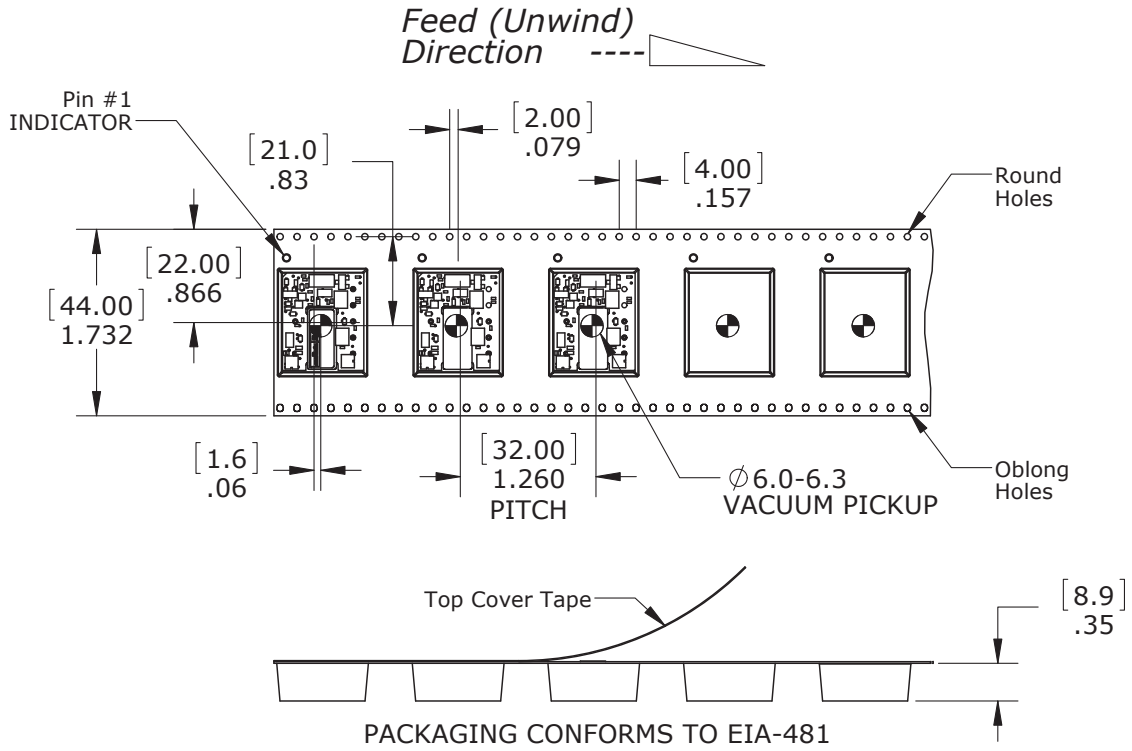

**TAPE AND REEL
(200 UNITS PER REEL)
PACKAGED AS MSL2**

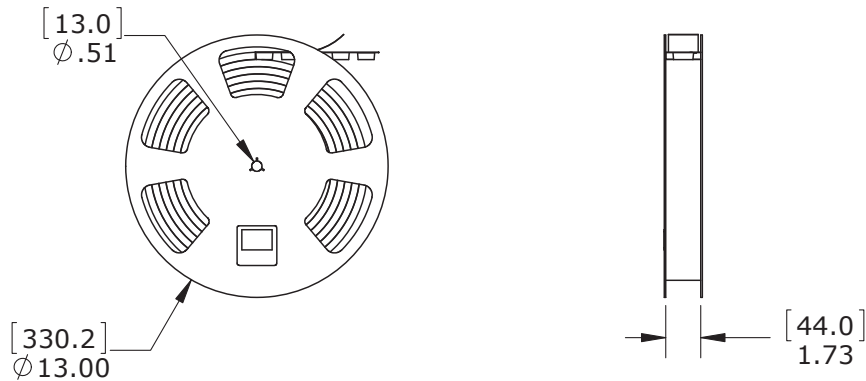

Dimensions are in inches (mm shown for ref. only).

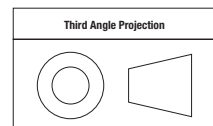

Tolerances (unless otherwise specified):
.XX ± 0.02 (0.5)
.XXX ± 0.010 (0.25)
Angles ± 1°

Components are shown for reference only.

TECHNICAL NOTES

Input Fusing

Certain applications and/or safety agencies may require the installation of fuses at the inputs of power conversion components. Fuses should also be used if the possibility of sustained, non-current-limited, input-voltage polarity reversals exists. For Murata Power Solutions' ULT series DC/DC converters, we recommend the use of a fast blow fuse, installed in the ungrounded input supply line with a typical value about twice the maximum input current, calculated at low line with the converter's minimum efficiency.

All relevant national and international safety standards and regulations must be observed by the installer. For system safety agency approvals, the converters must be installed in compliance with the requirements of the end-use safety standard.

Input Reverse-Polarity Protection

If the input voltage polarity is accidentally reversed, an internal diode will become forward biased and likely draw excessive current from the power source. If this source is not current limited or the circuit appropriately fused, it could cause permanent damage to the converter.

Input Under-Voltage Shutdown and Start-Up Threshold

Under normal start-up conditions, devices will not begin to regulate properly until the ramping-up input voltage exceeds the Start-Up Threshold Voltage. Once operating, devices will not turn off until the input voltage drops below the Under-Voltage Shutdown limit. Subsequent re-start will not occur until the input is brought back up to the Start-Up Threshold. This built-in hysteresis prevents any unstable on/off situations from occurring at a single input voltage.

Start-Up Time

The V_{IN} to V_{OUT} Start-Up Time is the time interval between the point at which the ramping input voltage crosses the Start-Up Threshold and the fully loaded output voltage enters and remains within its specified accuracy band. Actual measured times will vary with input source impedance, external input capacitance, and the slew rate and final value of the input voltage as it appears at the converter. The ULT Series implements a soft start circuit to limit the duty cycle of its PWM controller at power up, thereby limiting the input inrush current.

The On/Off Control to V_{OUT} start-up time assumes the converter has its nominal input voltage applied but is turned off via the On/Off Control pin. The specification defines the interval between the point at which the converter is turned on (released) and the fully loaded output voltage enters and remains within its specified accuracy band. Similar to the V_{IN} to V_{OUT} start-up, the On/Off Control to V_{OUT} start-up time is also governed by the internal soft start circuitry and external load capacitance. The difference in start up time from V_{IN} to V_{OUT} and from On/Off Control to V_{OUT} is therefore insignificant.

Input Source Impedance

The input of ULT converters must be driven from a low ac-impedance source. The DC/DC's performance and stability can be compromised by the use of highly inductive source impedances. The input circuit shown in Figure 2 is a practical solution that can be used to minimize the effects of inductance in the input traces. For optimum performance, components should be mounted close to the DC/DC converter.

I/O Filtering, Input Ripple Current, and Output Noise

All models in the ULT Series are tested/specified for input reflected ripple current and output noise using the specified external input/output components/

circuits and layout as shown in the following two figures. External input capacitors (C_{IN} in Figure 2) serve primarily as energy-storage elements, minimizing line voltage variations caused by transient IR drops in conductors from backplane to the DC/DC. Input caps should be selected for bulk capacitance (at appropriate frequencies), low ESR, and high rms-ripple-current ratings. The switching nature of DC/DC converters requires that dc voltage sources have low ac impedance as highly inductive source impedance can affect system stability. In Figure 2, CBUS and LBUS simulate a typical dc voltage bus. Your specific system configuration may necessitate additional considerations.

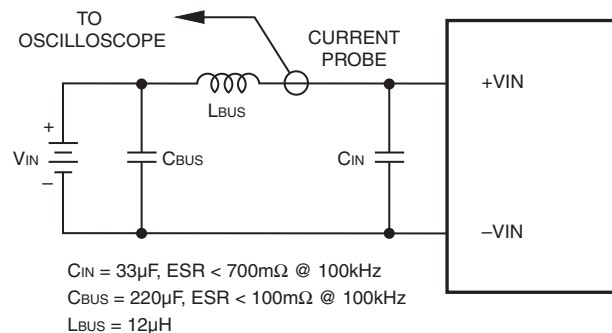

Figure 2. Measuring Input Ripple Current

In critical applications, output ripple/noise (also referred to as periodic and random deviations or PARD) may be reduced below specified limits using filtering techniques, the simplest of which is the installation of additional external output capacitors. They function as true filter elements and should be selected for bulk capacitance, low ESR and appropriate frequency response.

All external capacitors should have appropriate voltage ratings and be located as close to the converter as possible. Temperature variations for all relevant parameters should also be taken carefully into consideration. The most effective combination of external I/O capacitors will be a function of line voltage and source impedance, as well as particular load and layout conditions.

Floating Outputs

Since these are isolated DC/DC converters, their outputs are "floating" with respect to their input. Designers will normally use the -Output as the ground/return of the load circuit. You can however, use the +Output as ground/return to effectively reverse the output polarity.

Minimum Output Loading Requirements

ULT converters employ a synchronous-rectifier design topology and all models regulate within spec and are stable under no-load to full load conditions. Operation under no-load conditions however might slightly increase the output ripple and noise.

| Model | Tested with | Maximum Capacitance Loading |
|-----------------|---|-----------------------------|
| ULT-3.3/7.5-D48 | Four 100 μF output capacitors & Three 1 μF and 33 μF (low ESR) external input capacitors | 5000 μF |
| ULT-5/5-D48 | Four 100 μF output capacitors & Three 1 μF and 33 μF (low ESR) external input capacitors | 5000 μF |
| ULT-12/2.5-D48 | Four 47 μF output capacitors & three 1 μF and 33 μF (low ESR) external input capacitors. | 2200 μF |

Thirty-Second-Brick Isolated DC/DC Converters with 2:1 Wide Input Range

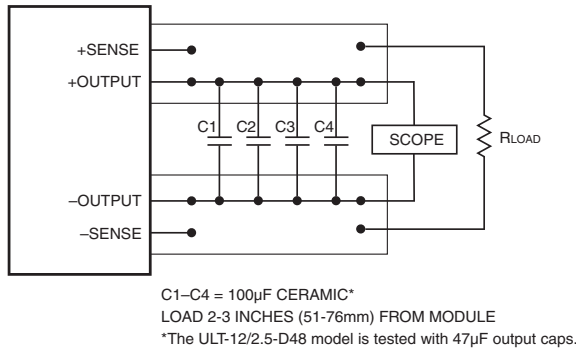

Figure 3. Measuring Output Ripple/Noise (PARD)

Thermal Shutdown

The ULT converters are equipped with thermal-shutdown circuitry. If environmental conditions cause the temperature of the DC/DC converter to rise above the designed operating temperature, a precision temperature sensor inside the PWM (see U1 in figure 4) will power down the unit. When the internal temperature decreases below the threshold of the temperature sensor, the unit will self-start. See Performance/Functional Specifications.

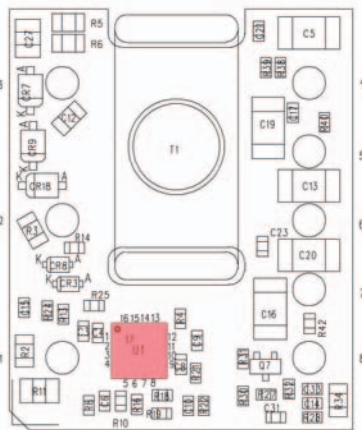

Figure 4. Thermal Shutdown

Output Over-Voltage Protection

The ULT output voltage is monitored for an over-voltage condition using a comparator. The signal is optically coupled to the primary side and if the output voltage rises to a level which could be damaging to the load, the sensing circuitry will power down the PWM controller causing the output voltage to decrease. Following a time-out period the PWM will restart, causing the output voltage to ramp to its appropriate value. If the fault condition persists, and the output voltage again climbs to excessive levels, the over-voltage circuitry will initiate another shutdown cycle. This on/off cycling is referred to as “hiccup” mode.

Current Limiting

As soon as the output current increases to approximately 130% of its rated value, the DC/DC converter will go into a current-limiting mode. In this condition, the output voltage will decrease proportionately with increases in output current, thereby maintaining somewhat constant power dissipation. This is commonly referred to as power limiting. Current limit inception is defined as the point at which the full-power output voltage falls below the specified tolerance. See Performance/Functional Specifications. If the load current, being drawn from the converter, is significant enough, the unit will go into a short circuit condition as described below.

Short Circuit Condition

When a converter is in current-limit mode, the output voltage will drop as the output current demand increases. If the output voltage drops too low, the magnetically coupled voltage used to develop primary side voltages will also drop, thereby shutting down the PWM controller. Following a time-out period, the PWM will restart causing the output voltage to begin ramping to their appropriate value. If the short-circuit condition persists, another shutdown cycle will be initiated. This on/off cycling is referred to as “hiccup” mode. The hiccup cycling reduces the average output current, thereby preventing internal temperatures from rising to excessive levels. The ULT Series is capable of enduring an indefinite short circuit output condition.

Remote Sense

Note: The Sense and V_{OUT} lines are internally connected through low-value resistors. Nevertheless, if the sense function is not used for remote regulation the user should connect the +Sense to +V_{OUT} and –Sense to –V_{OUT} at the DC/DC converter pins. ULT series converters employ a sense feature to provide point of use regulation, thereby overcoming moderate IR drops in PCB conductors or cabling. The remote sense lines carry very little current and therefore require minimal cross-sectional-area conductors. The sense lines, which are capacitively coupled to their respective output lines, are used by the feedback control-loop to regulate the output. As such, they are not low impedance points and must be treated with care in layouts and cabling. Sense lines on a PCB should be run adjacent to dc signals, preferably ground.

$$[V_{OUT(+)} - V_{OUT(-)}] - [Sense(+) - Sense(-)] \leq 10\% V_{OUT}$$

In cables and discrete wiring applications, twisted pair or other techniques should be used. Output over-voltage protection is monitored at the output voltage pin, not the Sense pin. Therefore, excessive voltage differences between V_{OUT} and Sense in conjunction with trim adjustment of the output voltage can cause the over-voltage protection circuitry to activate (see Performance Specifications for over-voltage limits). Power derating is based on maximum output current and voltage at the converter’s output pins. Use of trim and sense functions can cause output voltages to increase, thereby increasing output power beyond the converter’s specified rating, or cause output voltages to climb into the output over-voltage region. Therefore, the designer must ensure:

$$(V_{OUT \text{ at pins}}) \times (I_{OUT}) \leq \text{rated output power}$$

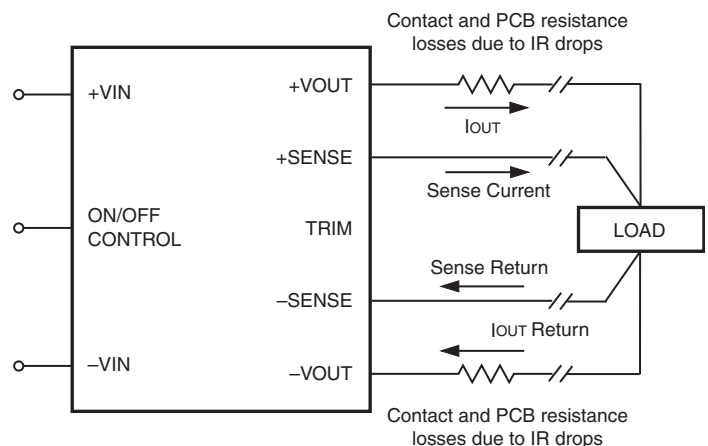

Figure 5. Remote Sense Circuit Configuration

Thirty-Second-Brick Isolated DC/DC Converters with 2:1 Wide Input Range

On/Off Control

The input-side, remote On/Off Control function can be ordered to operate with either logic type.

Positive ("P" suffix) logic models are enabled when the on/off pin is left open (or is pulled high, applying +10V to +15V with respect to -Input). Positive-logic devices are disabled when the on/off pin is pulled low (-0.7 to 0.9V with respect to -Input).

Negative ("N" suffix) logic devices are off when pin is left open (or pulled high, applying +10V to +15V), and on when pin is pulled low (-0.7 to +0.9V) with respect to -Input.

NOTE: Please refer to the Functional Specs for each specific ULT model.

Dynamic control of the remote on/off function is best accomplished with a mechanical relay or an open-collector/open-drain drive circuit (optically isolated if appropriate). The drive circuit should be able to sink appropriate current (see Performance Specifications) when activated and withstand appropriate voltage when deactivated. Applying an external voltage to pin 2 when no input power is applied to the converter can cause permanent damage to the converter.

OUTPUT VOLTAGE ADJUSTMENT

Trim Equations

Adjustable output voltage pin. If the Trim pin is left open circuit the output voltage is set to V_o nom. Adjustment by means of the external resistor must be possible to achieve an output voltage of V_o nom. +10% or -20%.

Connecting an external resistor between the TRIM pin and the -Sense pin decreases the output voltage set point. The following equation determines the required external resistor value to obtain a percentage output voltage change of $\Delta\%$:

$$R_{trim-down} = [(511/\Delta\%) - 10.22] \text{ K}\Omega$$

Where:

$$\Delta\% = [(V_o \text{ set} - V_{desired}) / V_o \text{ set}] \times 100$$

Connecting an external resistor between the TRIM pin and the +Sense pin increases the output voltage set point. The following equation determines the required external resistor value to obtain a percentage output voltage change of $\Delta\%$:

$$R_{trim-up} = [5.11 \times V_o \text{ set} \times (100 + \Delta\%) / (1.225 \times \Delta\%) - (511 / \Delta\%) - 10.22] \text{ K}\Omega$$

Where:

$$\Delta\% = [(V_{desired} - V_o \text{ set}) / V_o \text{ set}] \times 100$$

To maintain set point accuracy, the trim resistor tolerance should be at least $\pm 1.0\%$

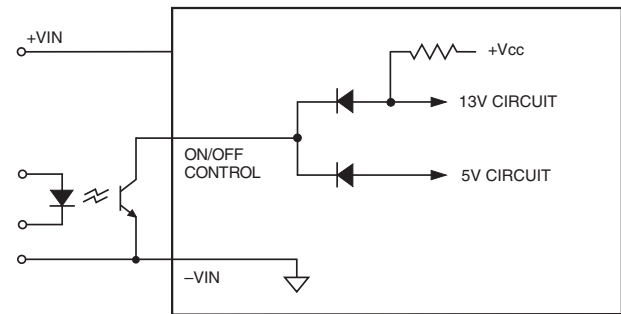

Figure 6. Driving the Negative Logic On/Off Control Pin (simplified circuit)

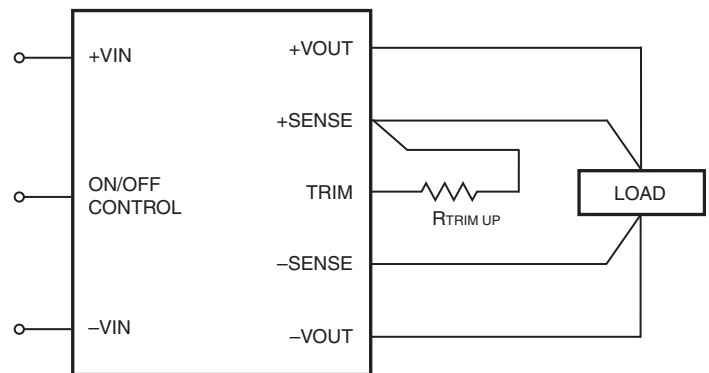

Figure 7. Trim Connections To Increase Output Voltages
Connect sense to its respective V_{out} pin if sense is not used with a remote load.

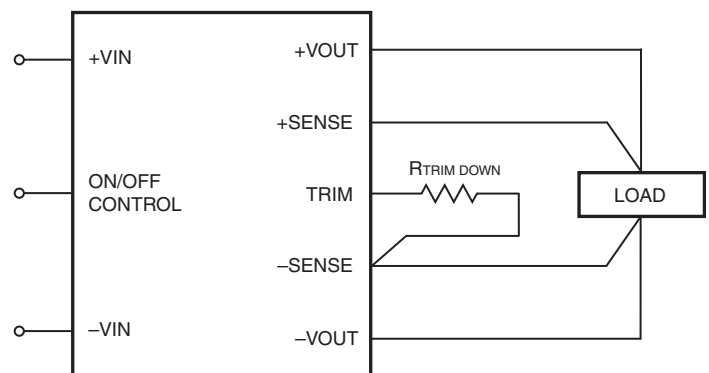

Figure 8. Trim Connections To Decrease Output Voltages

Thirty-Second-Brick Isolated DC/DC Converters with 2:1 Wide Input Range

Vertical Wind Tunnel

Murata Power Solutions employs a computer controlled custom-designed closed loop vertical wind tunnel, infrared video camera system, and test instrumentation for accurate airflow and heat dissipation analysis of power products. The system includes a precision low flow-rate anemometer, variable speed fan, power supply input and load controls, temperature gauges, and adjustable heating element.

The IR camera monitors the thermal performance of the Unit Under Test (UUT) under static steady-state conditions. A special optical port is used which is transparent to infrared wavelengths.

Both through-hole and surface mount converters are soldered down to a 10" x 10" host carrier board for realistic heat absorption and spreading. Both longitudinal and transverse airflow studies are possible by rotation of this carrier board since there are often significant differences in the heat dissipation in the two airflow directions. The combination of adjustable airflow, adjustable ambient heat, and adjustable Input/Output currents and voltages mean that a very wide range of measurement conditions can be studied.

The collimator reduces the amount of turbulence adjacent to the UUT by minimizing airflow turbulence. Such turbulence influences the effective heat transfer characteristics and gives false readings. Excess turbulence removes more heat from some surfaces and less heat from others, possibly causing uneven overheating.

Both sides of the UUT are studied since there are different thermal gradients on each side. The adjustable heating element and fan, built-in temperature gauges, and no-contact IR camera mean that power supplies are tested in real-world conditions.

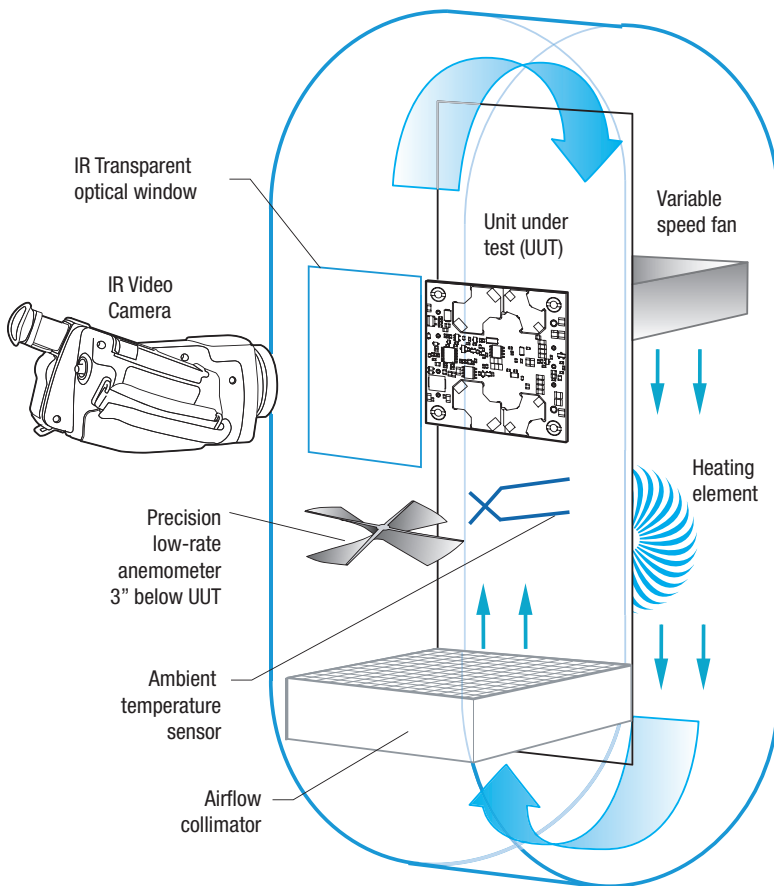

Figure 9. Vertical Wind Tunnel

Through-hole Soldering Guidelines

Murata Power Solutions recommends the TH soldering specifications below when installing these converters. These specifications vary depending on the solder type. Exceeding these specifications may cause damage to the product. Your production environment may differ; therefore please thoroughly review these guidelines with your process engineers.

| Wave Solder Operations for through-hole mounted products (THMT) | |
|---|-----------|
| For Sn/Ag/Cu based solders: | |
| Maximum Preheat Temperature | 115° C. |
| Maximum Pot Temperature | 270° C. |
| Maximum Solder Dwell Time | 7 seconds |
| For Sn/Pb based solders: | |
| Maximum Preheat Temperature | 105° C. |
| Maximum Pot Temperature | 250° C. |
| Maximum Solder Dwell Time | 6 seconds |

SMT Reflow Soldering Guidelines

The surface-mount reflow solder profile shown below is suitable for SAC305 type lead-free solders. This graph should be used only as a **guideline**. Many other factors influence the success of SMT reflow soldering. Since your production environment may differ, please thoroughly review these guidelines with your process engineers.

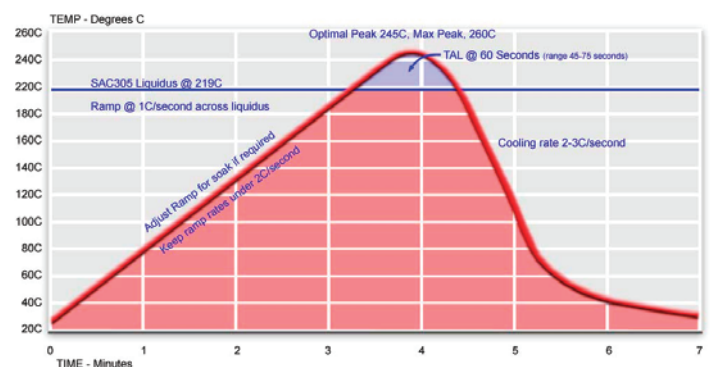

Murata Power Solutions, Inc.
11 Cabot Boulevard, Mansfield, MA 02048-1151 U.S.A.
ISO 9001 and 14001 REGISTERED



This product is subject to the following operating requirements and the Life and Safety Critical Application Sales Policy: Refer to: <http://www.murata-ps.com/requirements/>

Murata Power Solutions, Inc. makes no representation that the use of its products in the circuits described herein, or the use of other technical information contained herein, will not infringe upon existing or future patent rights. The descriptions contained herein do not imply the granting of licenses to make, use, or sell equipment constructed in accordance therewith. Specifications are subject to change without notice. © 2016 Murata Power Solutions, Inc.