



### FEATURES

- Patent Protected
- UL60950 recognised
- Footprint over pins 0.69cm<sup>2</sup>
- Single & dual isolated output
- 1kVDC Isolation “Hi Pot Test”
- Efficiency up to 88% (Typ.)
- MSL Level 1
- Power density 1.71W/cm<sup>3</sup>
- Wide temperature performance at full 1 Watt load, -40°C to 85°C
- UL 94V-0 Package material
- 3.3V, 5V & 12V Input
- 5V, 9V, 12V & 15V single & dual outputs
- Toroidal magnetics
- Custom solutions available
- Multi-layer ceramic capacitors

### PRODUCT OVERVIEW

The MTU1 series is a new range of miniature surface mount, high performance 1W DC/DC converters. With a footprint reduction of over 50% from the previous generation of 1W SMD DC/DC, the MTU1 series offers 1W of available output power over the full industrial temperature range of -40°C to 85°C. The MTU1 series is more efficient and offers improved regulation performance for applications where a wide output voltage variation can not be tolerated.

The devices are suitable for all applications where high volume production is envisaged.



For full details go to [www.murata-ps.com/rohs](http://www.murata-ps.com/rohs)



### SELECTION GUIDE

Order Code <sup>1</sup>	Nominal Input Voltage	Output Voltage	Output Current	Load Regulation (Typ.)	Load Regulation (Max)	Ripple & Noise (Typ.) <sup>3</sup>	Ripple & Noise (Max.) <sup>3</sup>	Input Current at Full Load	Efficiency (Min.)	Efficiency (Typ.)	Isolation Capacitance	MTTF <sup>2</sup>
	V	V	mA	%	%	mVp-p	mVp-p	mA	%	%	pF	kHrs
MTU1S0305MC	3.3	5	200	8.9	11.0	26	60	367	79	81	14	7660
MTU1S0505MC	5	5	200	7.3	9	35	60	241	80	83	19	5664
MTU1S0509MC	5	9	111	6.1	7.5	15	25	233	83	86	20	5488
MTU1S0512MC	5	12	83	5.6	7.5	15	25	230	84	87	21	5186
MTU1S0515MC	5	15	67	5.3	6.5	15	25	230	84	87	22	4773
MTU1S1205MC	12	5	200	5.6	8	20	40	99	80	84	22	5641
MTU1S1209MC	12	9	111	3.9	6	15	25	96	82	87	31	5467
MTU1S1212MC	12	12	83	3.5	6	10	25	95	83	88	40	5165
MTU1S1215MC	12	15	67	3.2	5	10	25	95	84	88	35	4753
MTU1D0305MC	3.3	±5	±100	8.0	9.5	18	35	356	80	83	17	5292
MTU1D0505MC	5	±5	±100	6.6	8	14	30	235	81	84	18	5053
MTU1D0509MC	5	±9	±56	5.6	6.5	7	20	229	83	86	21	5078
MTU1D0512MC	5	±12	±42	5.0	6	8	20	228	83	87	19	5545
MTU1D0515MC	5	±15	±33	5.1	6.5	8	20	224	84	88	22	5293
MTU1D1205MC	12	±5	±100	4.3	5	14	30	98	80	85	18	4335
MTU1D1209MC	12	±9	±56	3.1	4	7	20	95	82	87	27	4601
MTU1D1212MC	12	±12	±42	3.0	4	8	20	94	84	88	35	4834
MTU1D1215MC	12	±15	±33	2.6	3.5	8	20	94	84	88	35	4782

### INPUT CHARACTERISTICS

Parameter	Conditions	Min.	Typ.	Max.	Units
Voltage range	Continuous operation, 3.3V input types	2.97	3.3	3.63	V
	Continuous operation, 5V input types	4.5	5.0	5.5	
	Continuous operation, 12V input types	10.8	12.0	13.2	
Reflected ripple current	Single output types		3.3V input types	10	mA p-p
			5V input types	6	
			12V input types	5	
	Dual output types	All variants	5		

### ISOLATION CHARACTERISTICS

Parameter	Conditions	Min.	Typ.	Max.	Units
Isolation voltage	Flash tested for 1 second	1000			VDC
Resistance	Viso= 1000VDC	10			GΩ

### GENERAL CHARACTERISTICS

Parameter	Conditions	Min.	Typ.	Max.	Units
Switching frequency	MTU1D0305MC		70		kHz
	3.3V & 5V input, all output types (except MTU1D0305MC)		82		
	12V input, single output types		90		
	12V input, dual output types		100		

### OUTPUT CHARACTERISTICS

Parameter	Conditions	Min.	Typ.	Max.	Units
Rated power	T <sub>A</sub> =-40°C to 85°C			1.0	W
Voltage set point accuracy	See tolerance envelope				
Line regulation	High V <sub>IN</sub> to low V <sub>IN</sub>		1.0	1.1	%/%

1. If components are required in tape and reel format suffix order code with -R, e.g. MTU10505MC-R.
2. Calculated using MIL-HDBK-217 FN2 calculation model with nominal input voltage at full load.
3. See ripple & noise characterisation method.

All specifications typical at T<sub>A</sub>=25°C, nominal input voltage and rated output current unless otherwise specified.

### ABSOLUTE MAXIMUM RATINGS

Input voltage $V_{in}$ , MTU1S03 types	5.5V
Input voltage $V_{in}$ , MTU1S05 types	7V
Input voltage $V_{in}$ , MTU1S12 types	15V

### TEMPERATURE CHARACTERISTICS

Parameter	Conditions	Min.	Typ.	Max.	Units
Specification	All output types	-40		85	°C
Storage		-55		125	
Case temperature rise above ambient <sup>1</sup>	MTU1xxx05MC		15		
	MTU1xxx09MC		14		
	MTU1xxx12MC & MTU1xxx15MC		11		
Cooling	Free air convection				

1. Measured after 1 hour continuous operation at nominal  $V_{in}$  full load at the center of each PCB.

### TECHNICAL NOTES

#### ISOLATION VOLTAGE

'Hi Pot Test', 'Flash Tested', 'Withstand Voltage', 'Proof Voltage', 'Dielectric Withstand Voltage' & 'Isolation Test Voltage' are all terms that relate to the same thing, a test voltage, applied for a specified time, across a component designed to provide electrical isolation, to verify the integrity of that isolation.

Murata Power Solutions MTU1 series of DC/DC converters are all 100% production tested at their stated isolation voltage. This is 1kVDC for 1 second.

A question commonly asked is, "What is the continuous voltage that can be applied across the part in normal operation?"

The MTU1 has been recognized by Underwriters Laboratory for functional insulation, both input and output should normally be maintained within SELV limits i.e. less than 42.4V peak, or 60VDC. The isolation test voltage represents a measure of immunity to transient voltages and the part should never be used as an element of a safety isolation system. The part could be expected to function correctly with several hundred volts offset applied continuously across the isolation barrier; but then the circuitry on both sides of the barrier must be regarded as operating at an unsafe voltage and further isolation/insulation systems must form a barrier between these circuits and any user-accessible circuitry according to safety standard requirements.

#### REPEATED HIGH-VOLTAGE ISOLATION TESTING

It is well known that repeated high-voltage isolation testing of a barrier component can actually degrade isolation capability, to a lesser or greater degree depending on materials, construction and environment. The MTU1 series has toroidal isolation transformers, with no additional insulation between primary and secondary windings of enameled wire. While parts can be expected to withstand several times the stated test voltage, the isolation capability does depend on the wire insulation. Any material, including this enamel (typically polyurethane) is susceptible to eventual chemical degradation when subject to very high applied voltages thus implying that the number of tests should be strictly limited. We therefore strongly advise against repeated high voltage isolation testing, but if it is absolutely required, that the voltage be reduced by 20% from specified test voltage.

This consideration equally applies to agency recognized parts rated for better than functional isolation where the wire enamel insulation is always supplemented by a further insulation system of physical spacing or barriers.

### SAFETY APPROVAL

The MTU1 series has been recognized by Underwriters Laboratory (UL) to UL 60950 for functional insulation to a maximum product PCB temperature of 120°C. Forced air cooling may be used to maintain this temperature requirement. File number E151252 applies.

The MTU1 Series of converters are not internally fused so to meet the requirements of UL 60950 an anti-surge input line fuse should always be used with ratings as defined below.

MTU1X03xxxC: 0.750A

MTU1X05xxxC: 0.125A

MTU1X12xxxC: 0.315A

All fuses should be UL approved and rated to at least the maximum allowable DC input voltage.

### TEMPERATURE DERATING GRAPH

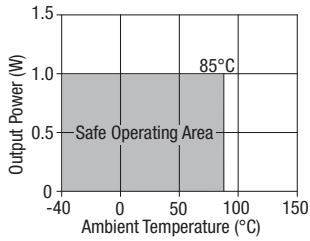

### RoHS COMPLIANCE INFORMATION



This series is compatible with RoHS soldering systems with a peak reflow solder temperature of 245°C as per J-STD-020D.1.

The pin termination finish on this product series is Matte Tin over Nickel Preplate. The series is backward compatible with Sn/Pb soldering systems. The series has a Moisture Sensitivity Level (MSL) 1.

Samples of the product series were tested in accordance with the conditioning described for MSL level 1 in IPS/J-STD-020D.1.

The product series passed electrical tests and visual inspection criteria.

For further information, please visit: [www.murata-ps.com/rohs](http://www.murata-ps.com/rohs)

### TOLERANCE ENVELOPES

3.3V Input Types

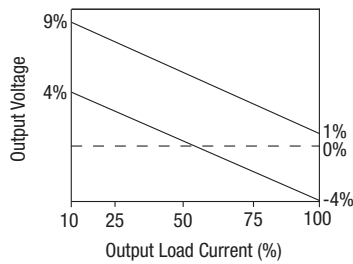

Single 5V output types (except 3.3V input)

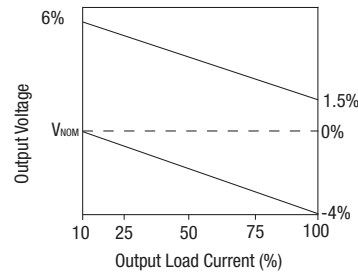

Dual 5V Output types (except 3.3V input)

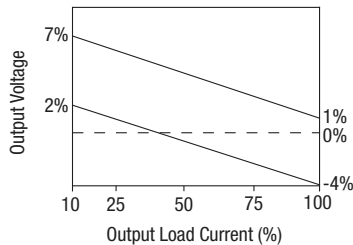

All other types

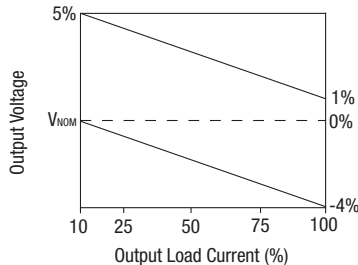

The voltage tolerance envelope shows typical load regulation characteristics for this product series. The tolerance envelope is the maximum output voltage variation due to changes in output loading and set point accuracy.

**APPLICATION NOTES**

**Minimum load**

The minimum load to meet datasheet specification is 10% of the full rated load across the specified input voltage range. Lower than 10% minimum loading will result in an increase in output voltage, which may rise to typically double the specified output voltage if the output load falls to less than 5%.

**Capacitive loading and start up**

Typical start up times for this series, with a typical input voltage rise time of 2.2µs and output capacitance of 10µF, are shown in the table below. The product series will start into a capacitance of 47µF with an increased start time, however, the maximum recommended output capacitance is 10µF.

	Start-up time		Start-up time
	ms		ms
MTU1S0305MC	1.7	MTU1D0305MC	3.1
MTU1S0505MC	0.9	MTU1D0505MC	1.8
MTU1S0509MC	2.7	MTU1D0509MC	5.7
MTU1S0512MC	4.3	MTU1D0512MC	10.1
MTU1S0515MC	7.5	MTU1D0515MC	19.1
MTU1S1205MC	0.9	MTU1D1205MC	1.5
MTU1S1209MC	1.9	MTU1D1209MC	4
MTU1S1212MC	3.3	MTU1D1212MC	7.5
MTU1S1215MC	4.7	MTU1D1215MC	12.5

Typical Start-Up Wave Form

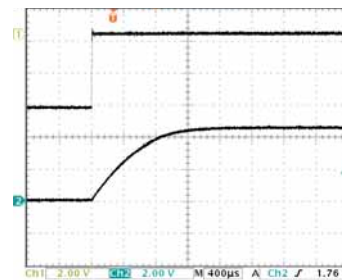

**Ripple & Noise Characterisation Method**

Ripple and noise measurements are performed with the following test configuration.

C1	1µF X7R multilayer ceramic capacitor, voltage rating to be a minimum of 3 times the output voltage of the DC/DC converter
C2	10µF tantalum capacitor, voltage rating to be a minimum of 1.5 times the output voltage of the DC/DC converter with an ESR of less than 100mΩ at 100 kHz
C3	100nF multilayer ceramic capacitor, general purpose
R1	450Ω resistor, carbon film, ±1% tolerance
R2	50Ω BNC termination
T1	3T of the coax cable through a ferrite toroid
RLOAD	Resistive load to the maximum power rating of the DC/DC converter. Connections should be made via twisted wires

Measured values are multiplied by 10 to obtain the specified values.

**Differential Mode Noise Test Schematic**

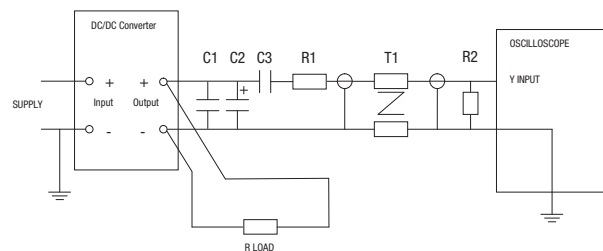

**APPLICATION NOTES CONTINUED**

**Output Ripple Reduction**

By using the values of inductance and capacitance stated, the output ripple at the rated load is lowered to 5mV p-p max.

**Component selection**

**Capacitor:** It is required that the ESR (Equivalent Series Resistance) should be as low as possible, ceramic types are recommended. The voltage rating should be at least twice (except for 15V output), the rated output voltage of the DC/DC converter.

**Inductor:** The rated current of the inductor should not be less than that of the output of the DC/DC converter. At the rated current, the DC resistance of the inductor should be such that the voltage drop across the inductor is <2% of the rated voltage of the DC/DC converter. The SRF (Self Resonant Frequency) should be >20MHz.

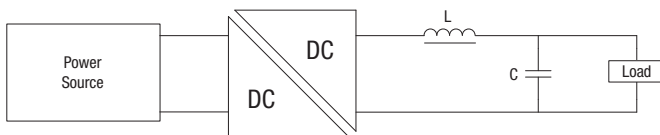

	Inductor			Capacitor
	L, $\mu$ H	SMD	Through Hole	C, $\mu$ F
MTU1S0305MC	10	82103C	11R103C	10
MTU1S0505MC	10	82103C	11R103C	4.7
MTU1S0509MC	22	82223C	11R223C	2.2
MTU1S0512MC	47	82473C	11R473C	1
MTU1S0515MC	47	82473C	11R473C	1
MTU1S1205MC	10	82103C	11R103C	4.7
MTU1S1209MC	22	82223C	11R223C	2.2
MTU1S1212MC	47	82473C	11R473C	1
MTU1S1215MC	47	82473C	11R473C	1
MTU1D0305MC	10	82103C	11R103C	10
MTU1D0505MC	10	82103C	11R103C	4.7
MTU1D0509MC	22	82223C	11R223C	2.2
MTU1D0512MC	47	82473C	11R473C	1
MTU1D0515MC	47	82473C	11R473C	1
MTU1D1205MC	10	82103C	11R103C	4.7
MTU1D1209MC	22	82223C	11R223C	2.2
MTU1D1212MC	47	82473C	11R473C	1
MTU1D1215MC	47	82473C	11R473C	1

## EFFICIENCY VS LOAD

**MTU1x03xxMC**

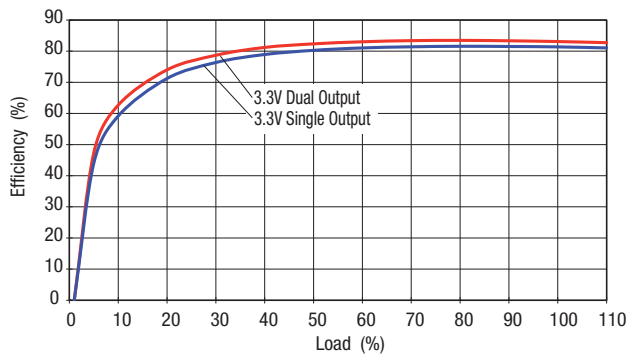

**MTUx05xxMC**

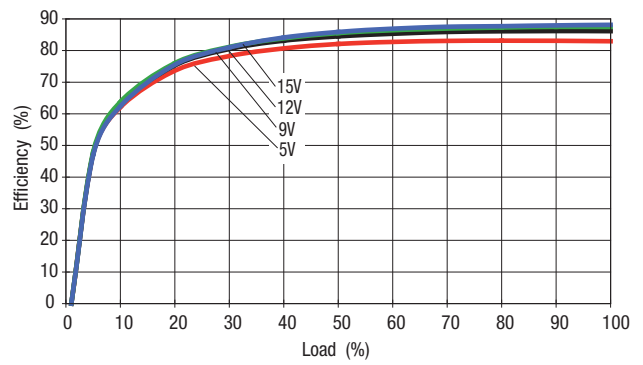

**MTU1x12xxMC**

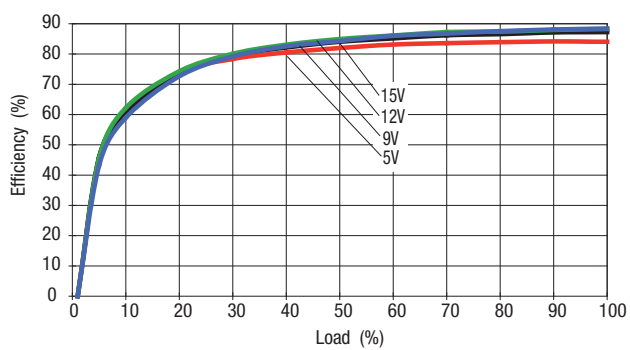

**PACKAGE SPECIFICATIONS**

**MECHANICAL DIMENSIONS - Patent Pending**

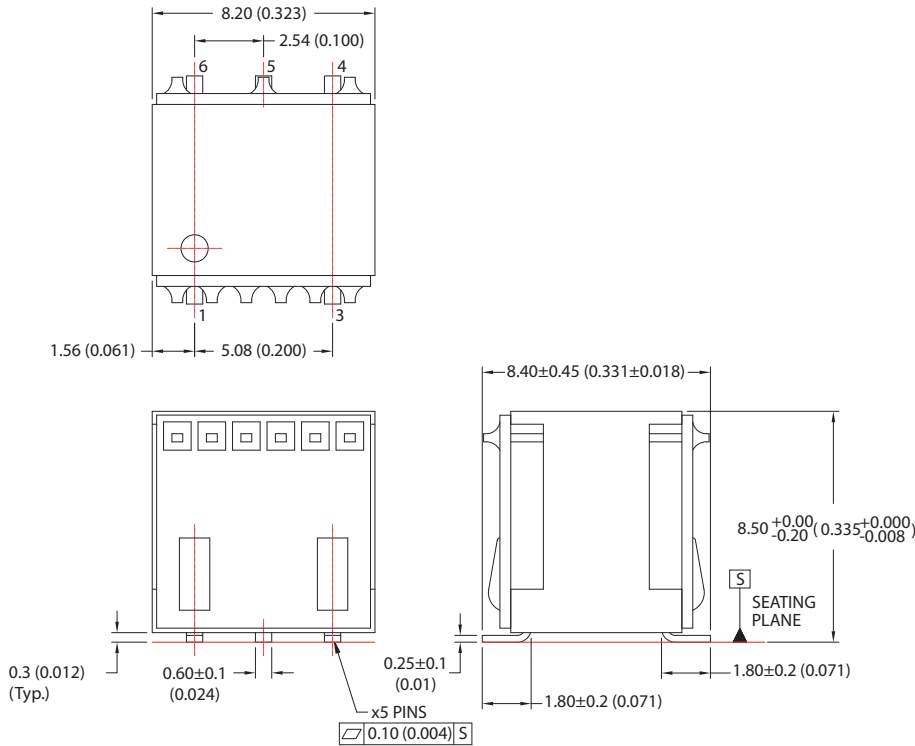

All dimensions in mm  $\pm 0.25$ mm (inches  $\pm 0.01$ ). All pins on a 2.54 (0.1) pitch and within 0.25 (0.01) of true position.

Weight: 0.75g, typ.

**PIN CONNECTIONS**

Single Output Types	
Pin	Function
1	+V <sub>IN</sub>
3	-V <sub>IN</sub>
4	NC
5	OV
6	+V <sub>OUT</sub>

Dual Output Types	
Pin	Function
1	+V <sub>IN</sub>
3	-V <sub>IN</sub>
4	-V <sub>OUT</sub>
5	OV
6	+V <sub>OUT</sub>

**RECOMMENDED FOOTPRINT DETAILS**

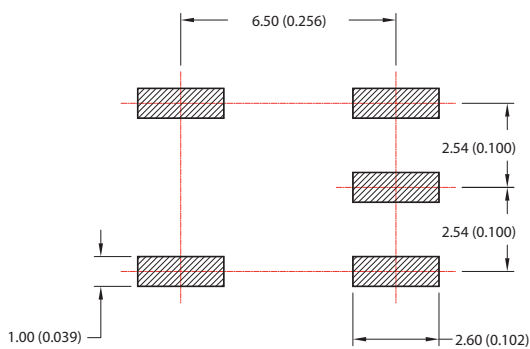

**TUBE OUTLINE DIMENSIONS**

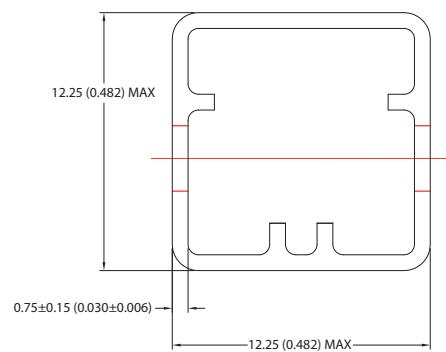

Unless otherwise stated all dimensions in mm  $\pm 0.25$ mm (inches).  
Tube length: 520mm  $\pm 2.00$

Tube Quantity: 60

**TAPE & REEL SPECIFICATIONS**

**REEL OUTLINE DIMENSIONS**

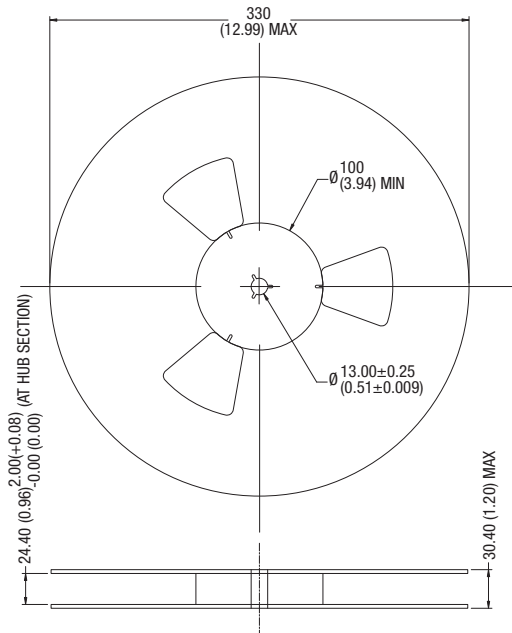

**TAPE OUTLINE DIMENSIONS**

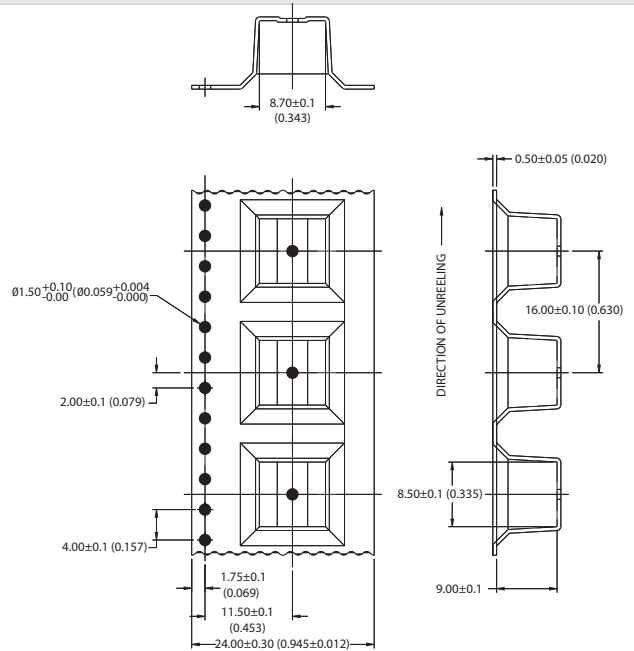

**REEL PACKAGING DETAILS**

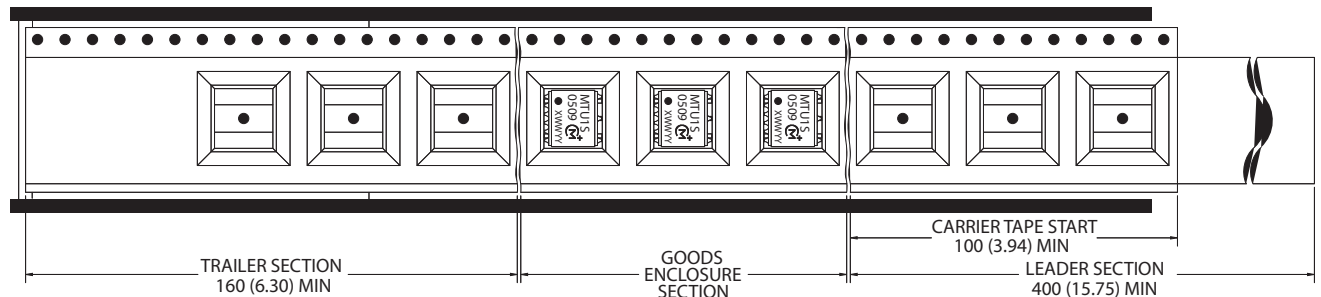

**Product Orientation**  
Pin 1, located nearest to carrier drive sprocket.  
  
Reel Quantity: 400 pcs.

Murata Power Solutions, Inc.  
11 Cabot Boulevard, Mansfield, MA 02048-1151 U.S.A.  
ISO 9001 and 14001 REGISTERED



This product is subject to the following **operating requirements** and the **Life and Safety Critical Application Sales Policy**:  
Refer to: <http://www.murata-ps.com/requirements/>

Murata Power Solutions, Inc. makes no representation that the use of its products in the circuits described herein, or the use of other technical information contained herein, will not infringe upon existing or future patent rights. The descriptions contained herein do not imply the granting of licenses to make, use, or sell equipment constructed in accordance therewith. Specifications are subject to change without notice.  
© 2015 Murata Power Solutions, Inc.