

Typical units

FEATURES

- 7-36Vin (3.3 & 5Vout), 15-36Vin (12Vout)
- Fixed Output: 3.3 or 5V @ 1.5A or 12V @ 1.0A
- Vertical SIP or horizontal mount, small footprint package
- “No heat sink” direct replacement for 3-terminal 78xx-series linear regulators
- High efficiency with no external components
- Short circuit protection
- Outstanding thermal derating performance
- UL/EN/IEC 60950-1, 2nd Edition safety approvals

PRODUCT OVERVIEW

Fabricated on a 0.41 x 0.65 inch (10.4 x 16.5 mm) Single Inline Package (SIP) module, the OKI-78SR series are non-isolated switching regulator (SR) DC-DC power converters for embedded applications. The fixed single output converters offer both tight regulation and high efficiency directly at the power usage site and are a direct plug-in replacement for TO-220 package 78xx series linear regulators. Typically, no extra outside components are required.

Three nominal output voltages are offered (3.3, 5 and 12 VDC), up to 1.5 Amp maximum output. Based on fixed-frequency buck switching topology, the high efficiency means very low heat and little electrical noise, requiring no external components. The 3.3 and 5Vout models have an ultra wide input range of 7 to 36 Volts DC and the 12Vout model has an input voltage range of 15 to 36V.

Protection features include short circuit current limit protection. The OKI-78SR is designed to meet all standards approvals. RoHS-6 (no lead) hazardous material compliance is specified as standard.

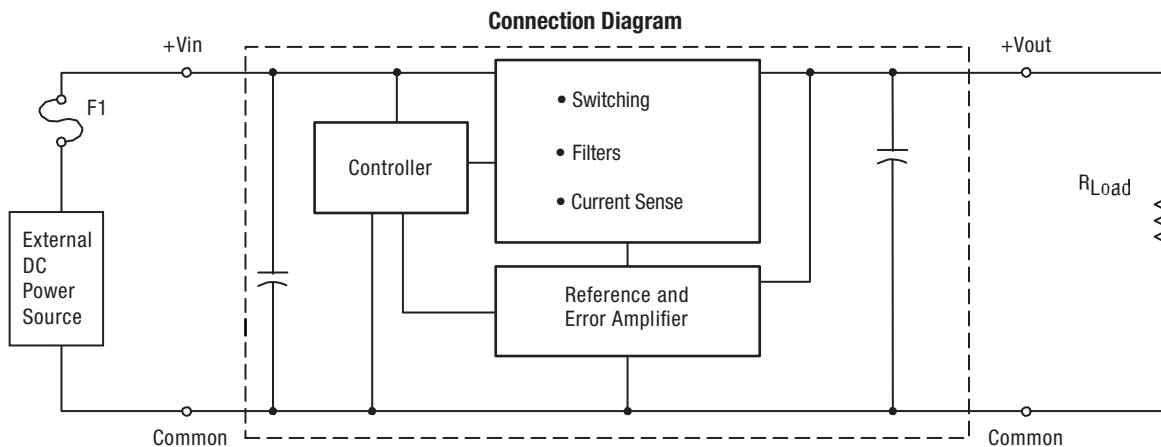

Figure 1. OKI-78SR

Note: Murata Power Solutions strongly recommends an external input fuse, F1. See specifications.



NEW

FUNCTIONAL SPECIFICATIONS SUMMARY AND ORDERING GUIDE													
Root Model	Output						Input				Efficiency		Package Inches (mm)
	V _{out} (Volts)	I _{out} (Amps max)	Power (Watts)	R/N (mVp-p)	Regulation (Typ.)		V _{in} Nom. (Volts)	Range (Volts)	I _{in} , no load (mA)	I _{in} , full load (Amps)	Min.	Typ.	
				Max.	Line	Load							
OKI-78SR-3.3/1.5-W36-C	3.3	1.5	4.95	40	±0.25%	±0.40%	12	7-36	5	0.48	84%	85.5%	0.41 x 0.3 x 0.65 (10.4 x 7.62 x 16.5)
OKI-78SR-5/1.5-W36-C	5	1.5	7.5	75	±0.25%	±0.40%	12	7-36	5	0.69	89%	90.5%	0.41 x 0.3 x 0.65 (10.4 x 7.62 x 16.5)
OKI-78SR-12/1.0-W36-C	12	1.0	12	75	±0.25%	±0.25%	24	15-36	5	0.53	93.5%	95.3%	0.41 x 0.3 x 0.65 (10.4 x 7.62 x 16.5)

NOTE: All specifications are at nominal line voltage, V_{out} = nominal and full load, +25°C with no external capacitor, unless otherwise noted.

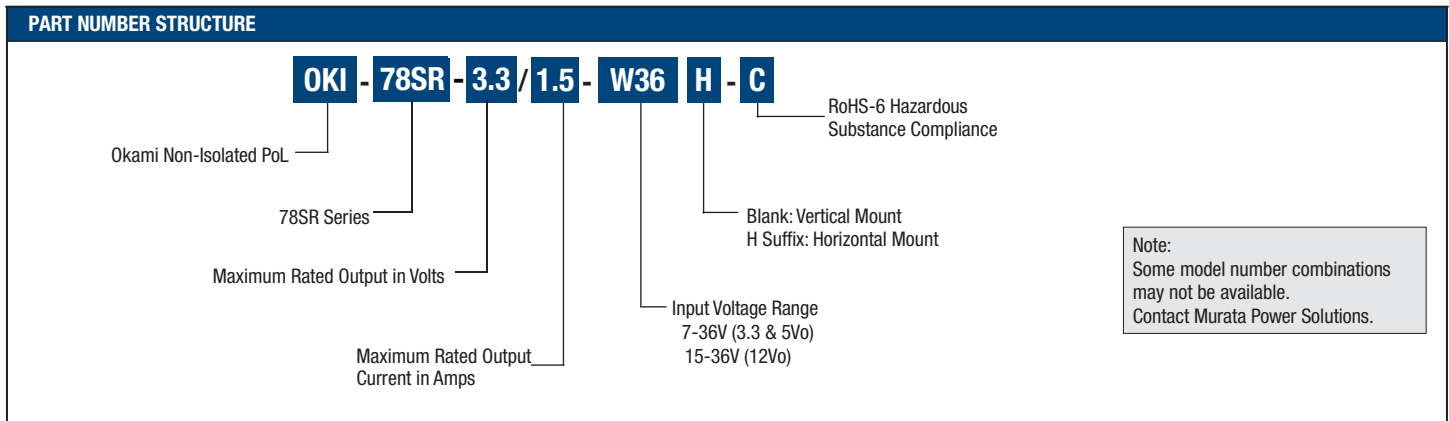

Product Label

Because of the small size of these products, the product label contains a character-reduced code to indicate the model number and manufacturing date code. Not all items on the label are always used. Please note that the label differs from the product photograph on page 1. Here is the layout of the label: The label contains three rows of information:

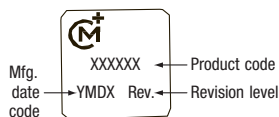

Figure 2. Label Artwork Layout

First row – Murata Power Solutions logo
 Second row – Model number product code (see table)
 Third row – Manufacturing date code and revision level

Model Number	Product
OKI-78SR-3.3/1.5-W36-C	I33115
OKI-78SR-5/1.5-W36-C	I50115
OKI-78SR-12/1.0-W36-C	I12110
OKI-78SR-3.3/1.5-W36H-C	I33115H
OKI-78SR-5/1.5-W36H-C	I50115H
OKI-78SR-12/1.0-W36H-C	I12110H

The manufacturing date code is four characters:

- First character – Last digit of manufacturing year, example 2009
- Second character – Month code (1 through 9 = Jan-Sep; 0, N, D = Oct, Nov, Dec)
- Third character – Day code (1 through 9 = 1 to 9, 10 = 0 and 11 through 31 = A through Z)
- Fourth character – Manufacturing information

FUNCTIONAL SPECIFICATIONS – OKI-78SR-3.3/1.5-W36-C

ABSOLUTE MAXIMUM RATINGS	Conditions ①	Minimum	Typical/Nominal	Maximum	Units
Input Voltage, Continuous	Full power operation	0		36	Vdc
Input Reverse Polarity	None, install external fuse		None		Vdc
Output Power		0		5.15	W
Output Current	Current-limited, no damage, short-circuit protected	0		1.5	A
Storage Temperature Range	Vin = Zero (no power)	-55		125	°C
Absolute maximums are stress ratings. Exposure of devices to greater than any of these conditions may adversely affect long-term reliability. Proper operation under conditions other than those listed in the Performance/Functional Specifications Table is not implied or recommended.					
INPUT					
Operating voltage range		7	12	36	Vdc
Recommended External Fuse	Fast blow			2	A
Reverse Polarity Protection ⑨	None, install external fuse		None		Vdc
Internal Filter Type			C-TYPE		
Input current					
Full Load Conditions	Vin = nominal		0.48	0.51	A
Low Line	Vin @ min		0.80	0.85	A
Inrush Transient			0.16		A ² -Sec.
Short Circuit Input Current			5		mA
No Load Input Current	Vin = nominal		5	10	mA
Shut-Down Mode Input Current			1		mA
Reflected (back) ripple current ②	(Cin = 2 X 100uF, CBus = 1000uF, LBus = 1uH)		50		mA, pk-pk
GENERAL and SAFETY					
Efficiency	@ Vin nom, 3.3Vout	83.7	85.5		%
	@ Vin min, 3.3Vout	87.0	88.4		%
Safety	Certified to UL-60950-1, IEC/EN60950-1, 2nd Edition		Yes		
Calculated MTBF ④	Per Telcordia SR332, issue 1, class 3, ground fixed, Tambient=+25°C		78.7		Hours x 10 ⁶
DYNAMIC CHARACTERISTICS					
Fixed Switching Frequency			500		kHz
Dynamic Load Response	50-100-50% load step, settling time to within ±2% of Vout di/dt = 1A/μSec		25	50	μSec
Dynamic Load Peak Deviation	same as above		100	150	mV

FUNCTIONAL SPECIFICATIONS – OKI-78SR-3.3/1.5-W36-C (CONT.)

OUTPUT	Conditions	Minimum	Typical/Nominal	Maximum	Units
Total Output Power		0	4.95	5.15	W
Voltage					
Nominal Output Voltage Range		3.168	3.3	3.432	Vdc
Setting Accuracy	At 50% load	-4		4	% of Vnom.
Output Voltage Overshoot - Startup:				3	%Vo nom
Current					
Output Current Range		0	1.5	1.5	A
Minimum Load ⑩			No minimum load		
Current Limit Inception	98% of Vnom., after warmup @3.3Vout	2.50	3.50	5.00	A
Short Circuit Mode ⑥⑪					
Short Circuit Current	Hiccup technique, autorecovery within ±1% of Vout		0.01		A
Short Circuit Duration (remove short for recovery)	Output shorted to ground, no damage		Continuous		
Short circuit protection method ⑧	Current limiting				
Regulation ④					
Total Regulation Band	Over all line, load and temp conditions	-3	Vo set	3	% Vo set
Line Regulation	Vin=min. to max. Vout=nom.			±0.25	%
Load Regulation	Iout=min. to max.			±0.40	%
Ripple and Noise (20MHz BW) ⑪	3.3Vo, 12Vin		30	40	mV pk-pk
Temperature Coefficient	At all outputs		±0.02		% of Vnom./°C
Maximum Capacitive Loading	low ESR; >0.001, <0.01 ohm		300		µF
Maximum Capacitive Loading	0.01 ohm		3300		µF
MECHANICAL					
Outline Dimensions			0.41 x 0.65 x 0.3		Inches
			10.4 x 16.5 x 7.62		mm
Weight			0.07		Ounces
			2		Grams
Pin Material			copper alloy		
Pin Finish	Matte Tin		100-300		µ"
	Nickel		75-150		µ"
ENVIRONMENTAL					
Operating Ambient Temperature Range ③	see derating curves	-40		85	°C
Storage Temperature	Vin = Zero (no power)	-55		125	°C
RoHS Compliant			RoHS-6		

Specification Notes:

- All specifications are typical unless noted. General conditions for Specifications are +25 deg.C ambient temperature, Vin=nominal, Vout=nominal, full rated load. Adequate airflow must be supplied for extended testing under power. See Derating curves..
- Input Back Ripple Current is tested and specified over a 5 Hz to 20 MHz bandwidth. Input filtering is Cin=2 x 100 µF, Cbus=1000 µF, Lbus=1 µH. All caps are low ESR types.
- Note that Maximum Power Derating curves indicate an average current at nominal input voltage. At higher temperatures and/or lower airflow, the DC/DC converter will tolerate brief full current outputs if the total RMS current over time does not exceed the Derating curve. All Derating curves are presented near sea level altitude. Be aware of reduced power dissipation with increasing altitude.
- Mean Time Before Failure is calculated using the Telcordia (Belcore) SR-332 Method 1, Case 3, ground fixed conditions, Tpcboard=+25 °C, full output load, natural air convection.
- The input and output are not isolated. They share a single COMMON power and signal return.
- Short circuit shutdown begins when the output voltage degrades approximately 2% from the selected setting. Output current limit and short circuit protection are non-latching. When the overcurrent fault is removed, the converter will immediately recover.
- The output is not intended to sink appreciable reverse current.
- "Hiccup" overcurrent operation repeatedly attempts to restart the converter with a brief, full-current output. If the overcurrent condition still exists, the restart current will be removed and then tried again. This short current pulse prevents overheating and damaging the converter.
- Input Fusing: If reverse polarity is accidentally applied to the input, to ensure reverse input protection, always connect an external input fast-blow fuse in series with the +Vin input. Use approximately twice the full input current rating with nominal input voltage.
- Regulation specifications describe the deviation as the line input voltage or output load current is varied from a nominal midpoint value to either extreme.
- Output noise may be further reduced by installing an external filter. Do not exceed the maximum output capacitance. At zero output current and no external capacitor, the output may contain low frequency components which exceed the ripple specification. The output may be operated indefinitely with no load.

PERFORMANCE DATA – OKI-78SR-3.3/1.5-W36-C

Efficiency vs. Line Voltage and Load Current @ +25°C. (Vout = Vnom.)

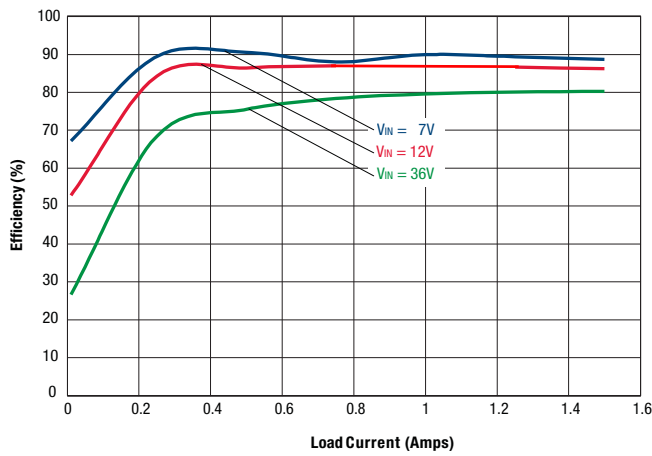

Maximum Current Temperature Derating at sea level (Vin=7V to 36V)

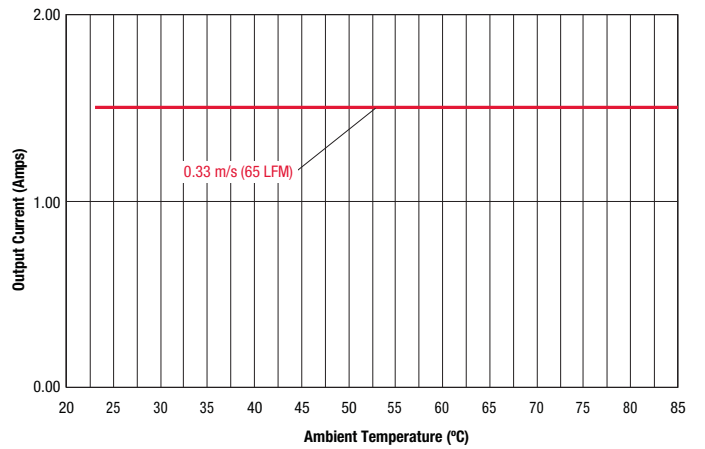

Output Ripple and Noise (Vin=7V, Vout=nominal, Iout=1.5A, Cload=0, Ta=+25°C., ScopeBW=100MHz)

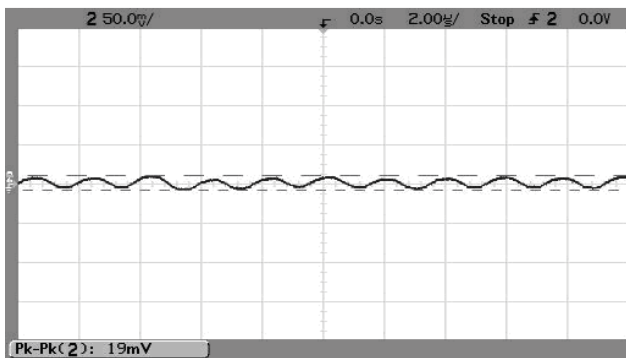

Output Ripple and Noise (Vin=12V, Vout=nominal, Iout=1.5A, Cload=0, Ta=+25°C., ScopeBW=100MHz)

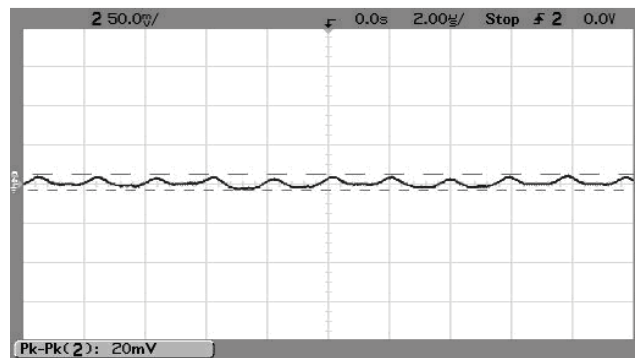

Output Ripple and Noise (Vin=36V, Vout=nominal, Iout=1.5A, Cload=0, Ta=+25°C., ScopeBW=100MHz)

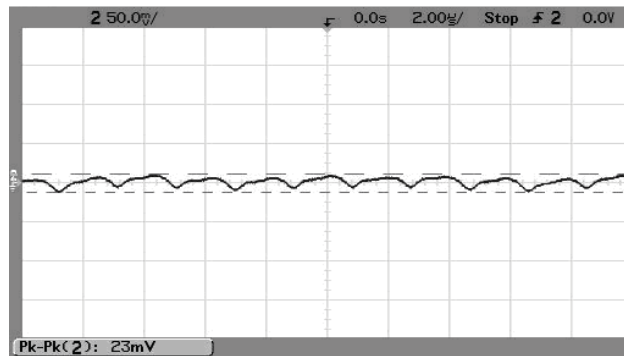

PERFORMANCE DATA – OKI-78SR-3.3/1.5-W36-C

Step Load Transient Response ($V_{in}=7V$, $V_{out}=\text{nominal}$, $\text{Clad}=0$, $I_{out}=0.75A$ to $1.5A$, $\text{Slew}=1A/\mu\text{S}$, $T_a=+25^\circ\text{C}$.) Trace 2= V_{out} , 100 mV/div. Trace 4= I_{out} , 0.5A/div

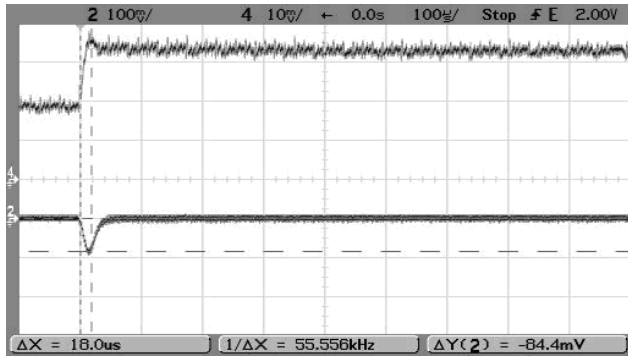

Step Load Transient Response ($V_{in}=7V$, $V_{out}=\text{nominal}$, $\text{Clad}=0$, $I_{out}=1.5A$ to $0.75A$, $\text{Slew}=1A/\mu\text{S}$, $T_a=+25^\circ\text{C}$.) Trace 2= V_{out} , 100 mV/div. Trace 4= I_{out} , 0.5A/div.

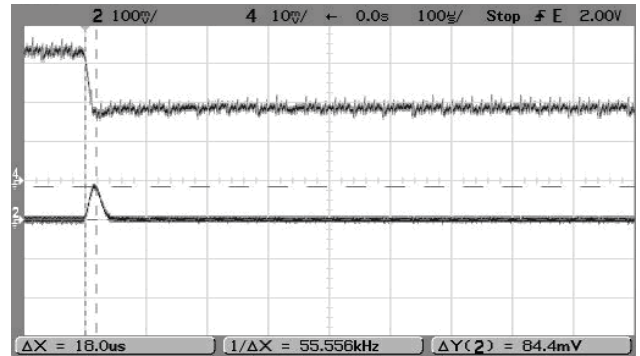

Step Load Transient Response ($V_{in}=12V$, $V_{out}=\text{nominal}$, $\text{Clad}=0$, $I_{out}=0.75A$ to $1.5A$, $\text{Slew}=1A/\mu\text{S}$, $T_a=+25^\circ\text{C}$.) Trace 2= V_{out} , 100 mV/div. Trace 4= I_{out} , 0.5A/div.

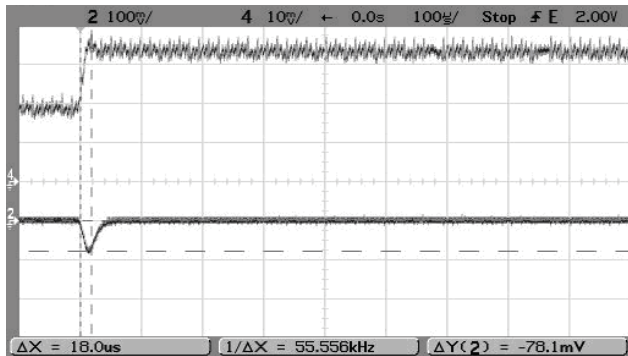

Step Load Transient Response ($V_{in}=12V$, $V_{out}=\text{nominal}$, $\text{Clad}=0$, $I_{out}=1.5A$ to $0.75A$, $\text{Slew}=1A/\mu\text{S}$, $T_a=+25^\circ\text{C}$.) Trace 2= V_{out} , 100 mV/div. Trace 4= I_{out} , 0.5A/div.

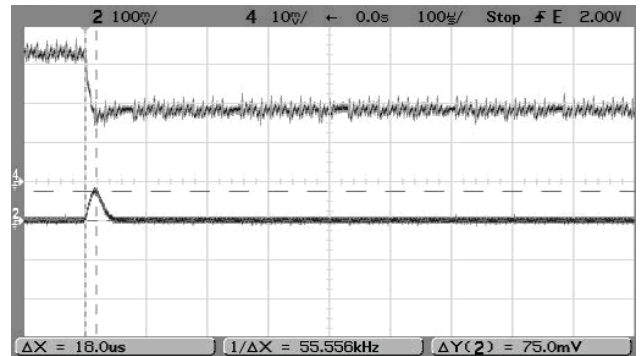

Step Load Transient Response ($V_{in}=36V$, $V_{out}=\text{nominal}$, $\text{Clad}=0$, $I_{out}=0.75A$ to $1.5A$, $\text{Slew}=1A/\mu\text{S}$, $T_a=+25^\circ\text{C}$.) Trace 2= V_{out} , 100 mV/div. Trace 4= I_{out} , 0.5A/div.

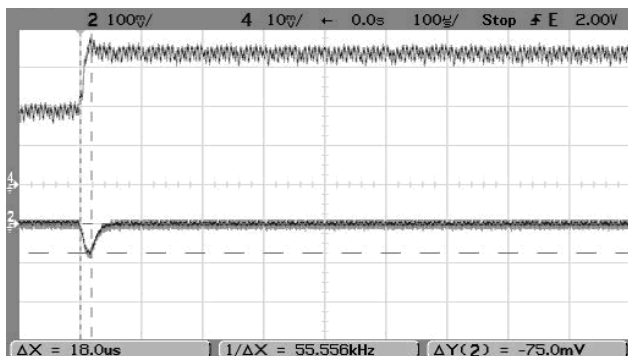

Step Load Transient Response ($V_{in}=36V$, $V_{out}=\text{nominal}$, $\text{Clad}=0$, $I_{out}=1.5A$ to $0.75A$, $\text{Slew}=1A/\mu\text{S}$, $T_a=+25^\circ\text{C}$.) Trace 2= V_{out} , 100 mV/div. Trace 4= I_{out} , 0.5A/div.

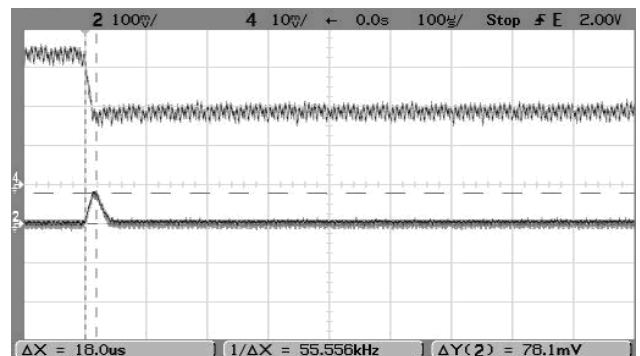

FUNCTIONAL SPECIFICATIONS – OKI-78SR-5/1.5-W36-C

ABSOLUTE MAXIMUM RATINGS	Conditions ①	Minimum	Typical/Nominal	Maximum	Units
Input Voltage, Continuous	Full power operation	0		36	Vdc
Input Reverse Polarity	None, install external fuse		None		Vdc
Output Power		0		7.80	W
Output Current	Current-limited, no damage, short-circuit protected	0		1.5	A
Storage Temperature Range	Vin = Zero (no power)	-55		125	°C
Absolute maximums are stress ratings. Exposure of devices to greater than any of these conditions may adversely affect long-term reliability. Proper operation under conditions other than those listed in the Performance/Functional Specifications Table is not implied or recommended.					
INPUT					
Operating voltage range		7	12	36	Vdc
Recommended External Fuse	Fast blow			2	A
Reverse Polarity Protection ②	None, install external fuse		None		Vdc
Internal Filter Type			C-TYPE		
Input current					
Full Load Conditions	Vin = nominal		0.69	0.73	A
Low Line	Vin @ min		1.16	1.22	A
Inrush Transient			0.16		A ² -Sec.
Short Circuit Input Current			5		mA
No Load Input Current	Vin = nominal		5	10	mA
Shut-Down Mode Input Current			1		mA
Reflected (back) ripple current ②	(Cin = 2 X 100uF, CBus = 1000uF, LBus = 1uH)		15		mA, pk-pk
GENERAL and SAFETY					
Efficiency	@ Vin nom, 5Vout	89.0	90.5		%
	@ Vin min, 5Vout	91.4	92.5		%
Safety	Certified to UL-60950-1, IEC/EN60950-1, 2nd Edition		Yes		
Calculated MTBF ④	Per Telcordia SR332, issue 1, class 3, ground fixed, Tambient=+25°C		78.7		Hours x 10 ⁶
DYNAMIC CHARACTERISTICS					
Fixed Switching Frequency			500		kHz
Dynamic Load Response	50-100-50% load step, settling time to within ±2% of Vout di/dt = 1A/µSec		50	75	µSec
Dynamic Load Peak Deviation	same as above		150	200	mV

FUNCTIONAL SPECIFICATIONS – OKI-78SR-5/1.5-W36-C (CONT.)

OUTPUT	Conditions	Minimum	Typical/Nominal	Maximum	Units
Total Output Power		0	7.5	7.8	W
Voltage					
Nominal Output Voltage Range		4.8	5.0	5.2	Vdc
Setting Accuracy	At 50% load	-4		4	% of Vnom.
Output Voltage Overshoot - Startup:				3	%Vo nom
Current					
Output Current Range		0	1.5	1.5	A
Minimum Load ⑩			No minimum load		
Current Limit Inception	98% of Vnom., after warmup @5Vout	2.50	3.50	5.00	A
Short Circuit Mode ⑥⑪					
Short Circuit Current	Hiccup technique, autorecovery within ±1% of Vout		0.01		A
Short Circuit Duration (remove short for recovery)	Output shorted to ground, no damage		Continuous		
Short circuit protection method ⑧	Current limiting				
Regulation ⑩					
Total Regulation Band	Over all line, load and temp conditions	-3	Vo set	3	% Vo set
Line Regulation	Vin=min. to max. Vout=nom.			±0.25	%
Load Regulation	Iout=min. to max.			±0.40	%
Ripple and Noise (20MHz BW) ⑪	5Vo, 12Vin		50	75	mV pk-pk
Temperature Coefficient	At all outputs		±0.02		% of Vnom./°C
Maximum Capacitive Loading	low ESR; >0.001, <0.01 ohm		300		µF
Maximum Capacitive Loading	0.01 ohm		3300		µF
MECHANICAL					
Outline Dimensions			0.41 x 0.65 x 0.3		Inches
			10.4 x 16.5 x 7.62		mm
Weight			0.07		Ounces
			2		Grams
Pin Material			copper alloy		
Pin Finish	Matte Tin		100-300		µ"
	Nickel		75-150		µ"
ENVIRONMENTAL					
Operating Ambient Temperature Range ③	see derating curves	-40		85	°C
Storage Temperature	Vin = Zero (no power)	-55		125	°C
RoHS Compliant			RoHS-6		

Specification Notes:

- All specifications are typical unless noted. General conditions for Specifications are +25 deg.C ambient temperature, Vin=nominal, Vout=nominal, full rated load. Adequate airflow must be supplied for extended testing under power. See Derating curves..
- Input Back Ripple Current is tested and specified over a 5 Hz to 20 MHz bandwidth. Input filtering is Cin=2 x 100 µF, Cbus=1000 µF, Lbus=1 µH. All caps are low ESR types.
- Note that Maximum Power Derating curves indicate an average current at nominal input voltage. At higher temperatures and/or lower airflow, the DC/DC converter will tolerate brief full current outputs if the total RMS current over time does not exceed the Derating curve. All Derating curves are presented near sea level altitude. Be aware of reduced power dissipation with increasing altitude.
- Mean Time Before Failure is calculated using the Telcordia (Belcore) SR-332 Method 1, Case 3, ground fixed conditions, Tpcboard=+25 °C, full output load, natural air convection.
- The input and output are not isolated. They share a single COMMON power and signal return.
- Short circuit shutdown begins when the output voltage degrades approximately 2% from the selected setting. Output current limit and short circuit protection are non-latching. When the overcurrent fault is removed, the converter will immediately recover.
- The output is not intended to sink appreciable reverse current.
- "Hiccup" overcurrent operation repeatedly attempts to restart the converter with a brief, full-current output. If the overcurrent condition still exists, the restart current will be removed and then tried again. This short current pulse prevents overheating and damaging the converter.
- Input Fusing: If reverse polarity is accidentally applied to the input, to ensure reverse input protection, always connect an external input fast-blow fuse in series with the +Vin input. Use approximately twice the full input current rating with nominal input voltage.
- Regulation specifications describe the deviation as the line input voltage or output load current is varied from a nominal midpoint value to either extreme.
- Output noise may be further reduced by installing an external filter. Do not exceed the maximum output capacitance. At zero output current and no external capacitor, the output may contain low frequency components which exceed the ripple specification. The output may be operated indefinitely with no load.

PERFORMANCE DATA – OKI-78SR-5/1.5-W36-C

Efficiency vs. Line Voltage and Load Current @ +25°C. (Vout = Vnom.)

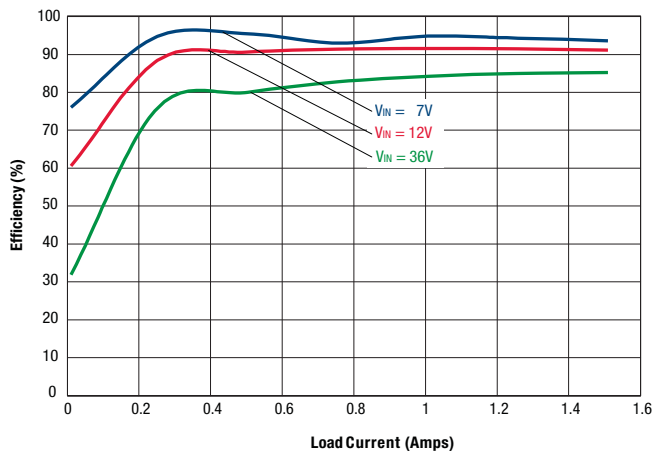

Maximum Current Temperature Derating at sea level (Vin=7V to 36V)

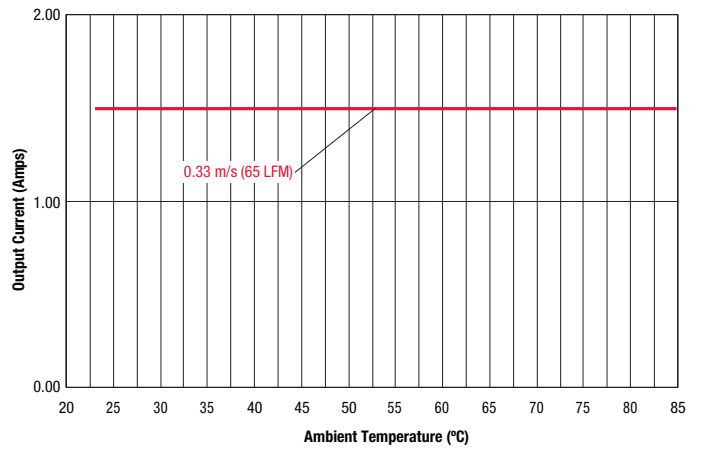

Output Ripple and Noise (Vin=7V, Vout=nominal, Iout=1.5A, Cload=0, Ta=+25°C., ScopeBW=100MHz)

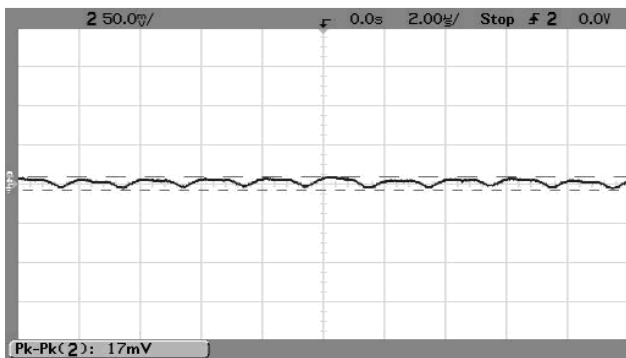

Output Ripple and Noise (Vin=12V, Vout=nominal, Iout=1.5A, Cload=0, Ta=+25°C., ScopeBW=100MHz)

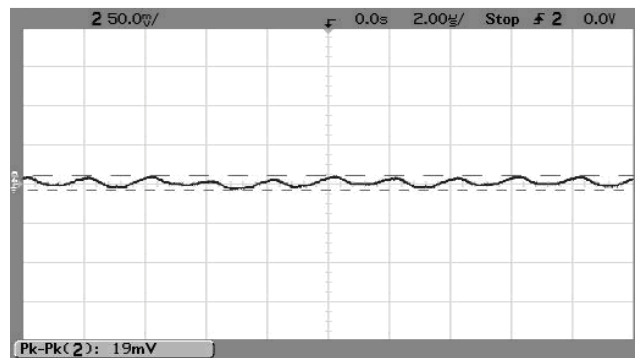

Output Ripple and Noise (Vin=36V, Vout=nominal, Iout=1.5A, Cload=0, Ta=+25°C., ScopeBW=100MHz)

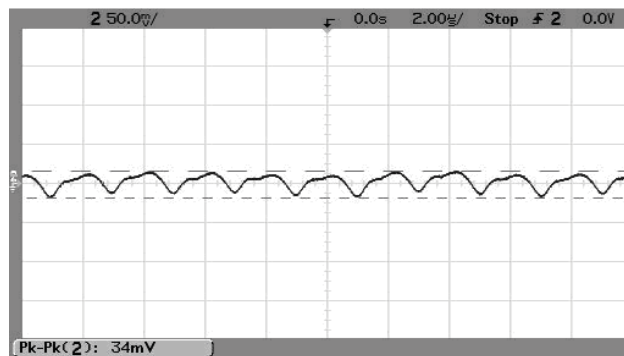

PERFORMANCE DATA – OKI-78SR-5/1.5-W36-C

Step Load Transient Response ($V_{in}=7V$, $V_{out}=\text{nominal}$, $\text{Cload}=0$, $I_{out}=0.75A$ to $1.5A$, Slew= $1A/\mu s$, $T_a=+25^\circ C$.) Trace 2= V_{out} , 100 mV/div. Trace 4= I_{out} , 0.5A/div.

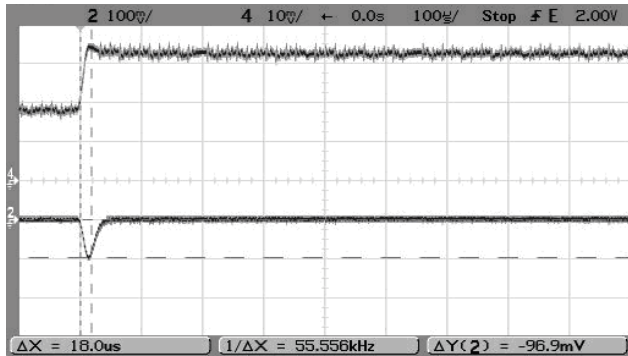

Step Load Transient Response ($V_{in}=7V$, $V_{out}=\text{nominal}$, $\text{Cload}=0$, $I_{out}=1.5A$ to $0.75A$, Slew= $1A/\mu s$, $T_a=+25^\circ C$.) Trace 2= V_{out} , 100 mV/div. Trace 4= I_{out} , 0.5A/div.

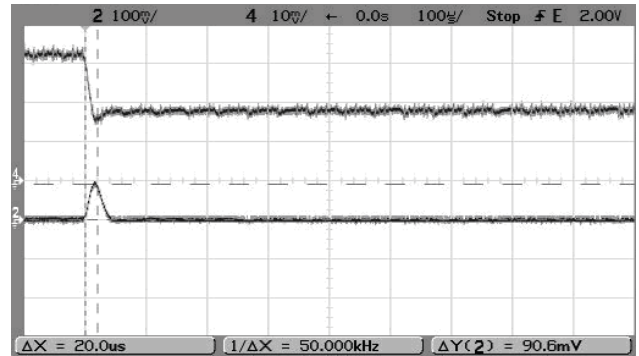

Step Load Transient Response ($V_{in}=12V$, $V_{out}=\text{nominal}$, $\text{Cload}=0$, $I_{out}=0.75A$ to $1.5A$, Slew= $1A/\mu s$, $T_a=+25^\circ C$.) Trace 2= V_{out} , 100 mV/div. Trace 4= I_{out} , 0.5A/div.

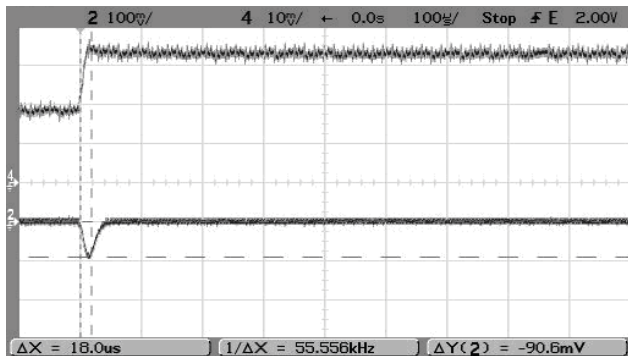

Step Load Transient Response ($V_{in}=12V$, $V_{out}=\text{nominal}$, $\text{Cload}=0$, $I_{out}=1.5A$ to $0.75A$, Slew= $1A/\mu s$, $T_a=+25^\circ C$.) Trace 2= V_{out} , 100 mV/div. Trace 4= I_{out} , 0.5A/div.

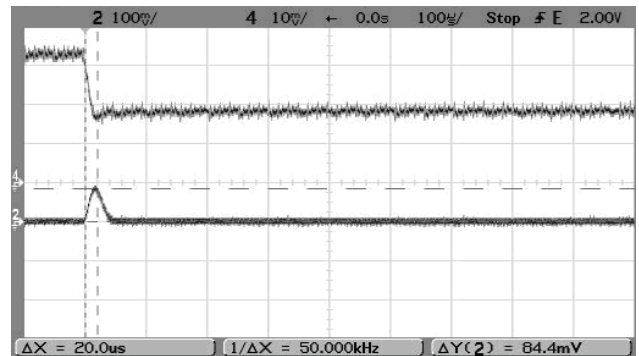

Step Load Transient Response ($V_{in}=36V$, $V_{out}=\text{nominal}$, $\text{Cload}=0$, $I_{out}=0.75A$ to $1.5A$, Slew= $1A/\mu s$, $T_a=+25^\circ C$.) Trace 2= V_{out} , 100 mV/div. Trace 4= I_{out} , 0.5A/div.

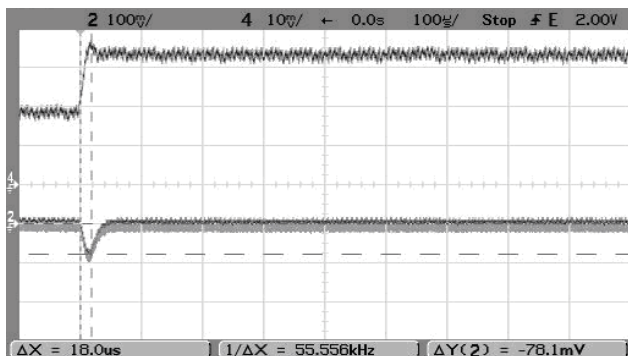

Step Load Transient Response ($V_{in}=36V$, $V_{out}=\text{nominal}$, $\text{Cload}=0$, $I_{out}=1.5A$ to $0.75A$, Slew= $1A/\mu s$, $T_a=+25^\circ C$.) Trace 2= V_{out} , 100 mV/div. Trace 4= I_{out} , 0.5A/div.

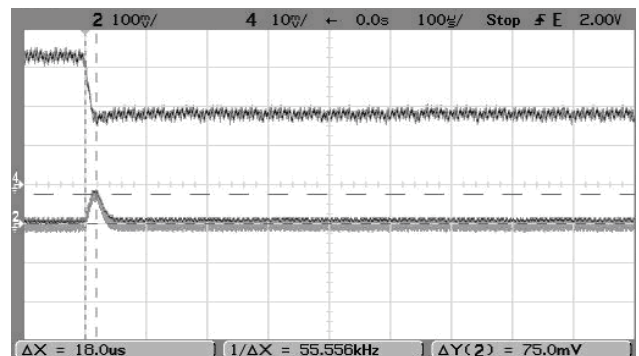

FUNCTIONAL SPECIFICATIONS – OKI-78SR-12/1.0-W36-C

ABSOLUTE MAXIMUM RATINGS	Conditions ①	Minimum	Typical/Nominal	Maximum	Units
Input Voltage, Continuous	Full power operation	0		36	Vdc
Input Reverse Polarity	None, install external fuse		None		Vdc
Output Power		0		5.15	W
Output Current	Current-limited, no damage, short-circuit protected	0		1.0	A
Storage Temperature Range	Vin = Zero (no power)	-55		125	°C
Absolute maximums are stress ratings. Exposure of devices to greater than any of these conditions may adversely affect long-term reliability. Proper operation under conditions other than those listed in the Performance/Functional Specifications Table is not implied or recommended.					
INPUT					
Operating voltage range		15	24	36	Vdc
Recommended External Fuse	Fast blow			2	A
Reverse Polarity Protection ⑨	None, install external fuse		None		Vdc
Internal Filter Type			C-TYPE		
Input current					
Full Load Conditions	Vin = nominal		0.53	0.56	A
Low Line	Vin @ min		0.84	0.87	A
Inrush Transient			0.16		A ² -Sec.
Short Circuit Input Current			5		mA
No Load Input Current	Vin = nominal		5	10	mA
Shut-Down Mode Input Current			1		mA
Reflected (back) ripple current ②	(Cin = 2 X 100uF, CBus = 1000uF, LBus = 1uH)		30		mA, pk-pk
GENERAL and SAFETY					
Efficiency	@ Vin nom, 12Vout	93.5	95.3		%
	@ Vin min, 12Vout	95.5	97.0		%
Safety	Certified to UL-60950-1, IEC/EN60950-1, 2nd Edition		Yes		
Calculated MTBF ④	Per Telcordia SR332, issue 1, class 3, ground fixed, Tambient=+25°C		25.9		Hours x 10 ⁶
DYNAMIC CHARACTERISTICS					
Fixed Switching Frequency			500		kHz
Dynamic Load Response	50-100-50% load step, settling time to within ±2% of Vout di/dt = 1A/μSec		50	75	μSec
Dynamic Load Peak Deviation	same as above		165	225	mV

FUNCTIONAL SPECIFICATIONS – OKI-78SR-12/1.0-W36-C (CONT.)

OUTPUT	Conditions	Minimum	Typical/Nominal	Maximum	Units
Total Output Power		0	12.0	12.5	W
Voltage					
Nominal Output Voltage Range		11.52	12.0	12.48	Vdc
Setting Accuracy	At 50% load	-4		4	% of Vnom.
Output Voltage Overshoot - Startup:				3	%Vo nom
Current					
Output Current Range		0	1.0	1.0	A
Minimum Load ⑩			No minimum load		
Current Limit Inception	98% of Vnom., after warmup @12Vout	2.50	3.50	5.00	A
Short Circuit Mode ⑥⑪					
Short Circuit Current	Hiccup technique, autorecovery within ±1% of Vout		0.01		A
Short Circuit Duration (remove short for recovery)	Output shorted to ground, no damage		Continuous		
Short circuit protection method ⑧	Current limiting				
Regulation ⑩					
Total Regulation Band	Over all line, load and temp conditions	-3	Vo set	3	% Vo set
Line Regulation	Vin=min. to max. Vout=nom.			±0.25	%
Load Regulation	Iout=min. to max.			±0.40	%
Ripple and Noise (20MHz BW) ⑪	12Vo, 24Vin		50	75	mV pk-pk
Temperature Coefficient	At all outputs		±0.02		% of Vnom./°C
Maximum Capacitive Loading	low ESR; >0.001, <0.01 ohm		300		µF
Maximum Capacitive Loading	0.01 ohm		3300		µF
MECHANICAL					
Outline Dimensions			0.41 x 0.65 x 0.3		Inches
			10.4 x 16.5 x 7.62		mm
Weight			0.07		Ounces
			2		Grams
Pin Material			copper alloy		
Pin Finish	Matte Tin		100-300		µ"
	Nickel		75-150		µ"
ENVIRONMENTAL					
Operating Ambient Temperature Range ③	see derating curves	-40		85	°C
Storage Temperature	Vin = Zero (no power)	-55		125	°C
RoHS Compliant			RoHS-6		

Specification Notes:

- All specifications are typical unless noted. General conditions for Specifications are +25 deg.C ambient temperature, Vin=nominal, Vout=nominal, full rated load. Adequate airflow must be supplied for extended testing under power. See Derating curves..
- Input Back Ripple Current is tested and specified over a 5 Hz to 20 MHz bandwidth. Input filtering is Cin=2 x 100 µF, Cbus=1000 µF, Lbus=1 µH. All caps are low ESR types.
- Note that Maximum Power Derating curves indicate an average current at nominal input voltage. At higher temperatures and/or lower airflow, the DC/DC converter will tolerate brief full current outputs if the total RMS current over time does not exceed the Derating curve. All Derating curves are presented near sea level altitude. Be aware of reduced power dissipation with increasing altitude.
- Mean Time Before Failure is calculated using the Telcordia (Belcore) SR-332 Method 1, Issue 2, Class 3, ground benign, controlled conditions, Tpcboard=+25 °C, full output load, natural air convection.
- The input and output are not isolated. They share a single COMMON power and signal return.
- Short circuit shutdown begins when the output voltage degrades approximately 2% from the selected setting. Output current limit and short circuit protection are non-latching. When the overcurrent fault is removed, the converter will immediately recover.
- The output is not intended to sink appreciable reverse current.
- "Hiccup" overcurrent operation repeatedly attempts to restart the converter with a brief, full-current output. If the overcurrent condition still exists, the restart current will be removed and then tried again. This short current pulse prevents overheating and damaging the converter.
- Input Fusing: If reverse polarity is accidentally applied to the input, to ensure reverse input protection, always connect an external input fast-blow fuse in series with the +Vin input. Use approximately twice the full input current rating with nominal input voltage.
- Regulation specifications describe the deviation as the line input voltage or output load current is varied from a nominal midpoint value to either extreme.
- Output noise may be further reduced by installing an external filter. Do not exceed the maximum output capacitance. At zero output current and no external capacitor, the output may contain low frequency components which exceed the ripple specification. The output may be operated indefinitely with no load.

PERFORMANCE DATA – OKI-78SR-12/1.0-W36-C

Efficiency vs. Line Voltage and Load Current @ +25°C. (Vout = Vnom.)

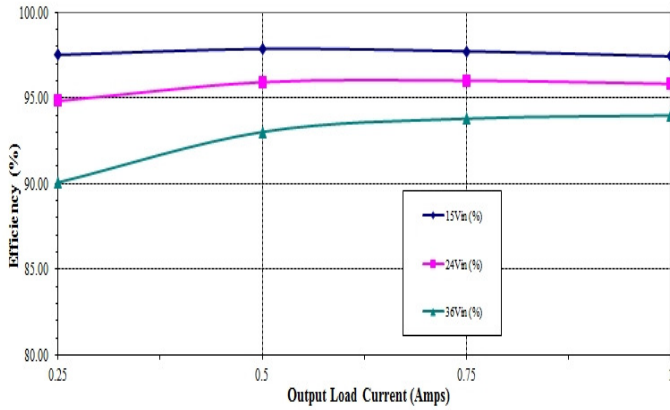

Maximum Current Temperature Derating at sea level (Vin=15V to 36V)

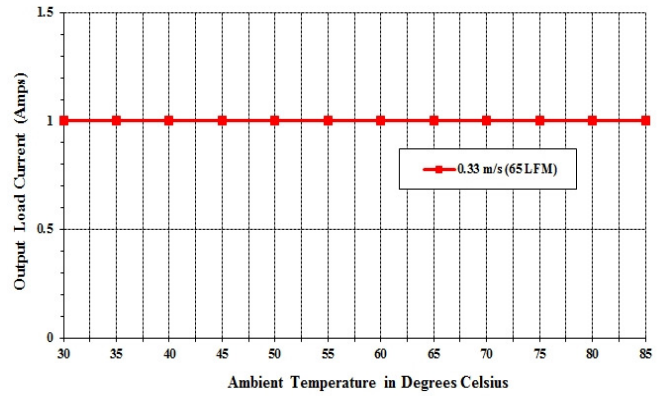

Output Ripple and Noise (Vin=15V, Vout=nominal, Iout=1A, Cload=0, Ta=+25°C, ScopeBW=100MHz)

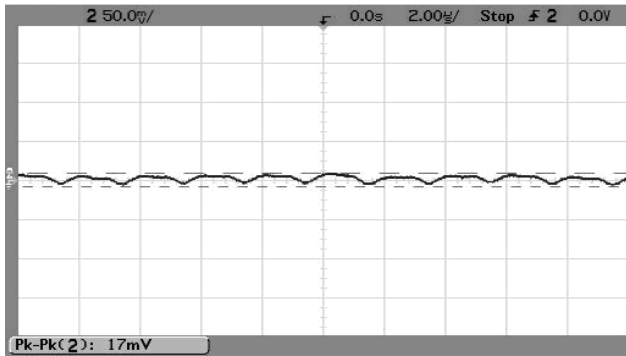

Output Ripple and Noise (Vin=24V, Vout=nominal, Iout=1A, Cload=0, Ta=+25°C, ScopeBW=100MHz)

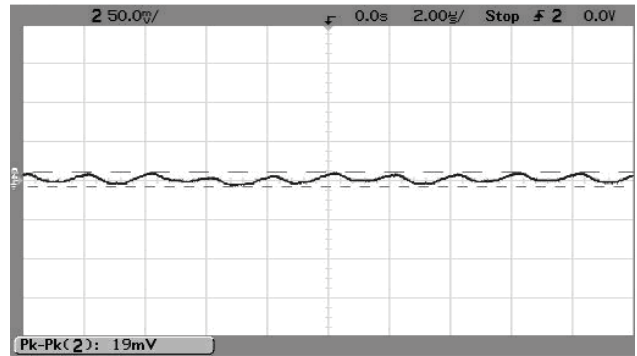

Output Ripple and Noise (Vin=36V, Vout=nominal, Iout=1A, Cload=0, Ta=+25°C, ScopeBW=100MHz)

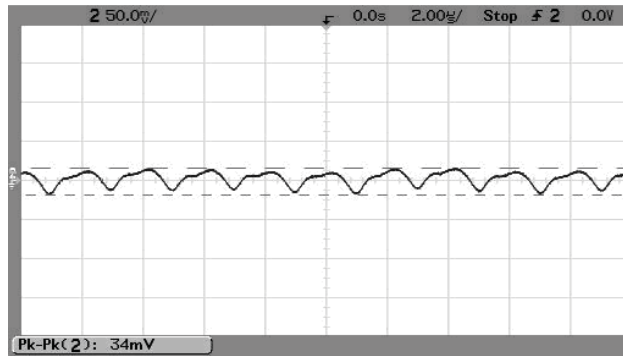

PERFORMANCE DATA – OKI-78SR-12/1.0-W36-C

Step Load Transient Response ($V_{in}=15V$, $V_{out}=\text{nominal}$, $\text{Cl}_{oad}=0$, $I_{out}=0.5A$ to $1.0A$, $\text{Slew}=1A/\mu\text{s}$, $T_a=+25^\circ\text{C}$.) Trace 2= V_{out} , 100 mV/div . Trace 4= I_{out} , $0.5A/div$.

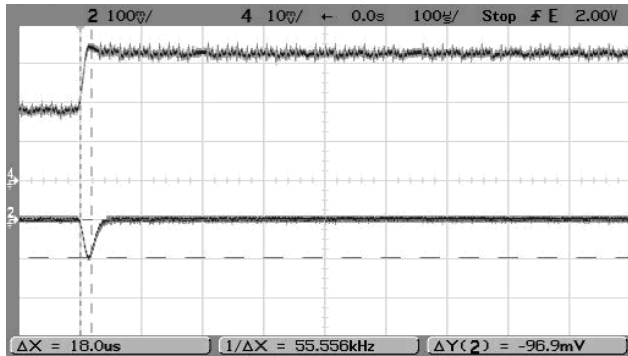

Step Load Transient Response ($V_{in}=15V$, $V_{out}=\text{nominal}$, $\text{Cl}_{oad}=0$, $I_{out}=1.0A$ to $0.5A$, $\text{Slew}=1A/\mu\text{s}$, $T_a=+25^\circ\text{C}$.) Trace 2= V_{out} , 100 mV/div . Trace 4= I_{out} , $0.5A/div$.

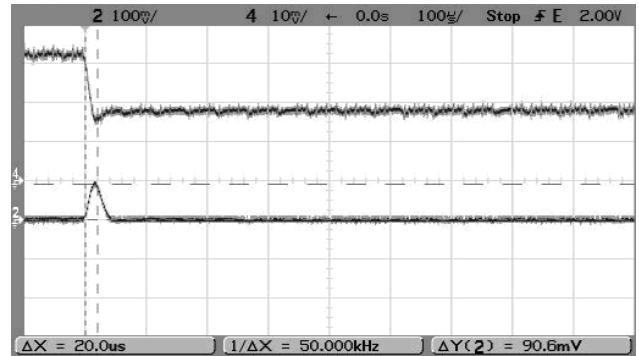

Step Load Transient Response ($V_{in}=24V$, $V_{out}=\text{nominal}$, $\text{Cl}_{oad}=0$, $I_{out}=0.5A$ to $1.0A$, $\text{Slew}=1A/\mu\text{s}$, $T_a=+25^\circ\text{C}$.) Trace 2= V_{out} , 100 mV/div . Trace 4= I_{out} , $0.5A/div$.

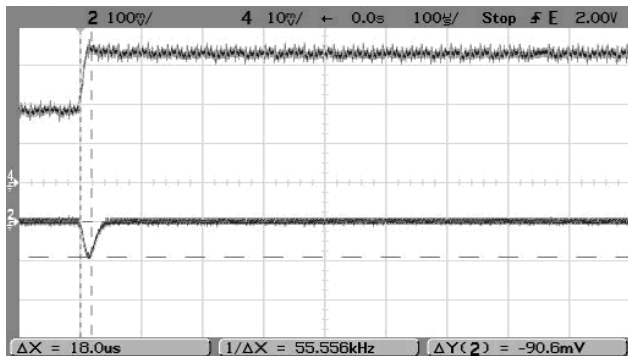

Step Load Transient Response ($V_{in}=24V$, $V_{out}=\text{nominal}$, $\text{Cl}_{oad}=0$, $I_{out}=1.0A$ to $0.5A$, $\text{Slew}=1A/\mu\text{s}$, $T_a=+25^\circ\text{C}$.) Trace 2= V_{out} , 100 mV/div . Trace 4= I_{out} , $0.5A/div$.

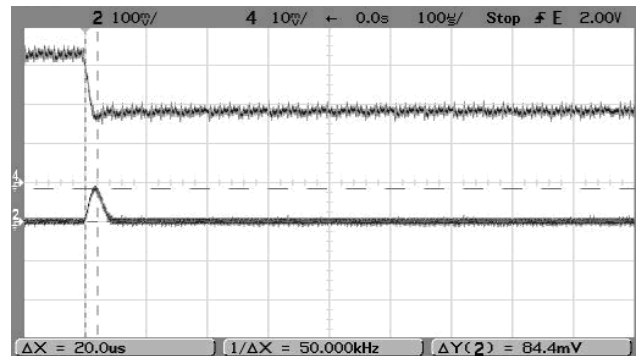

Step Load Transient Response ($V_{in}=36V$, $V_{out}=\text{nominal}$, $\text{Cl}_{oad}=0$, $I_{out}=0.5A$ to $1.0A$, $\text{Slew}=1A/\mu\text{s}$, $T_a=+25^\circ\text{C}$.) Trace 2= V_{out} , 100 mV/div . Trace 4= I_{out} , $0.5A/div$.

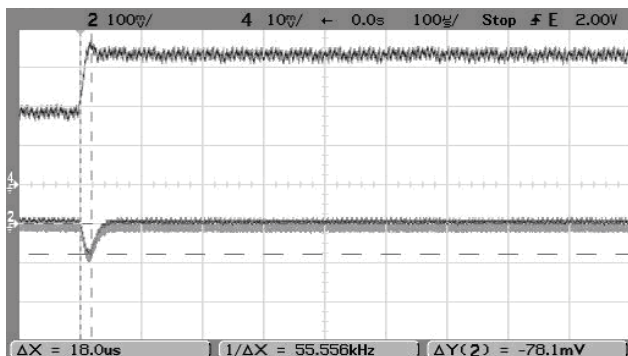

Step Load Transient Response ($V_{in}=36V$, $V_{out}=\text{nominal}$, $\text{Cl}_{oad}=0$, $I_{out}=1.0A$ to $0.5A$, $\text{Slew}=1A/\mu\text{s}$, $T_a=+25^\circ\text{C}$.) Trace 2= V_{out} , 100 mV/div . Trace 4= I_{out} , $0.5A/div$.

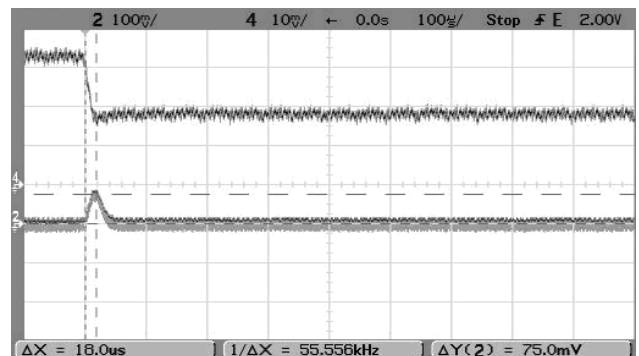

MECHANICAL SPECIFICATIONS -- VERTICAL MOUNT

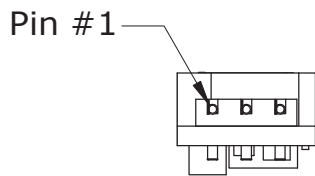
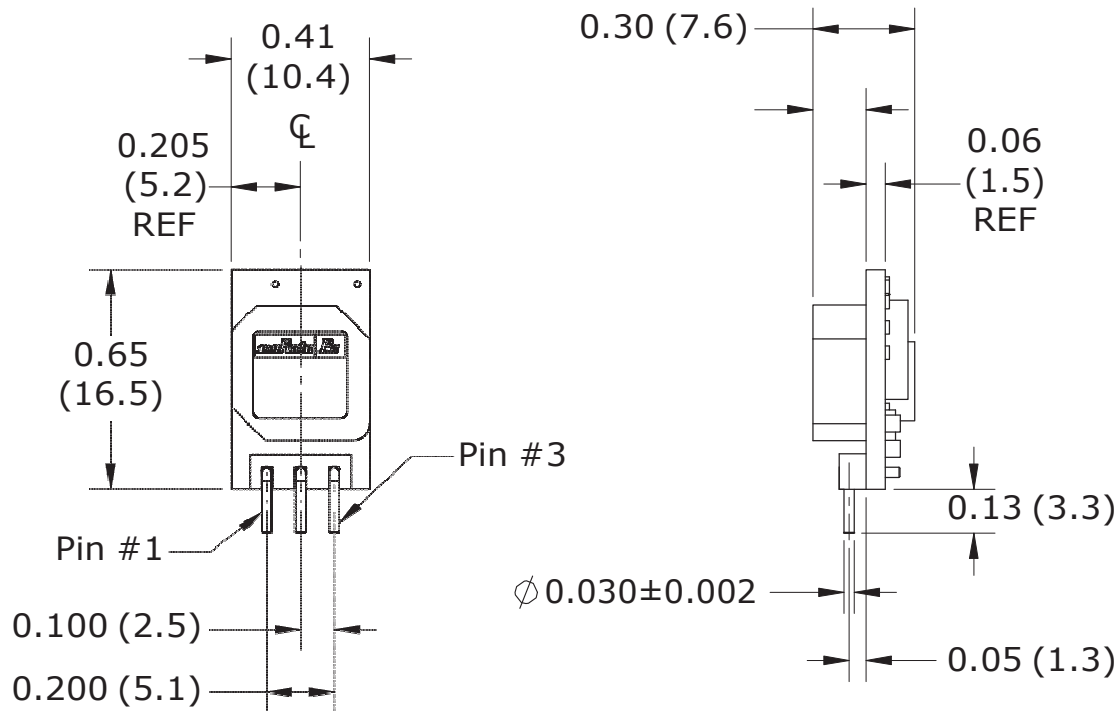

PIN MATERIAL: COPPER ALLOY
 PIN FINISH: PURE MATTE TIN 100-300 μ "
 OVER 75-150 μ " NICKEL

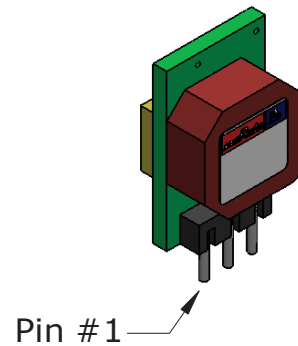

INPUT/OUTPUT CONNECTIONS OKI-78SR	
Pin	Function
1	Positive Input
2	Common (Ground)
3	Positive Output

Dimensions are in inches (mm shown for ref. only).

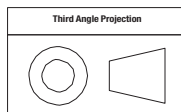

Tolerances (unless otherwise specified):
 .XX \pm 0.02 (0.5)
 .XXX \pm 0.010 (0.25)
 Angles \pm 1°

Components are shown for reference only.

MECHANICAL SPECIFICATIONS -- HORIZONTAL MOUNT

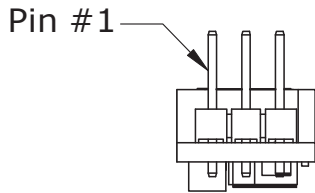
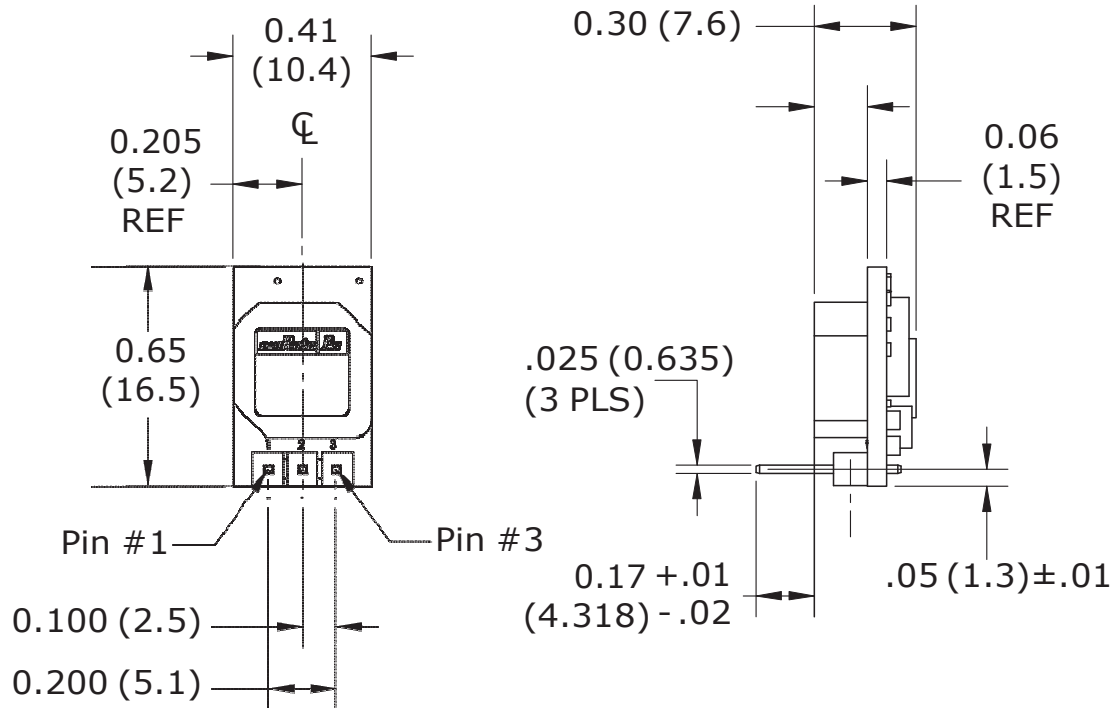

PIN MATERIAL: COPPER ALLOY
 PIN FINISH: PURE MATTE TIN 100-300 u"
 OVER 75-150 u" NICKEL

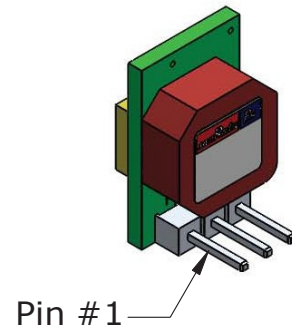

INPUT/OUTPUT CONNECTIONS OKI-78SR	
Pin	Function
1	Positive Input
2	Common (Ground)
3	Positive Output

Dimensions are in inches (mm shown for ref. only).

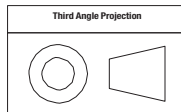

Tolerances (unless otherwise specified):
 .XX ± 0.02 (0.5)
 .XXX ± 0.010 (0.25)
 Angles ± 1°

Components are shown for reference only.

RECOMMENDED FOOTPRINTS

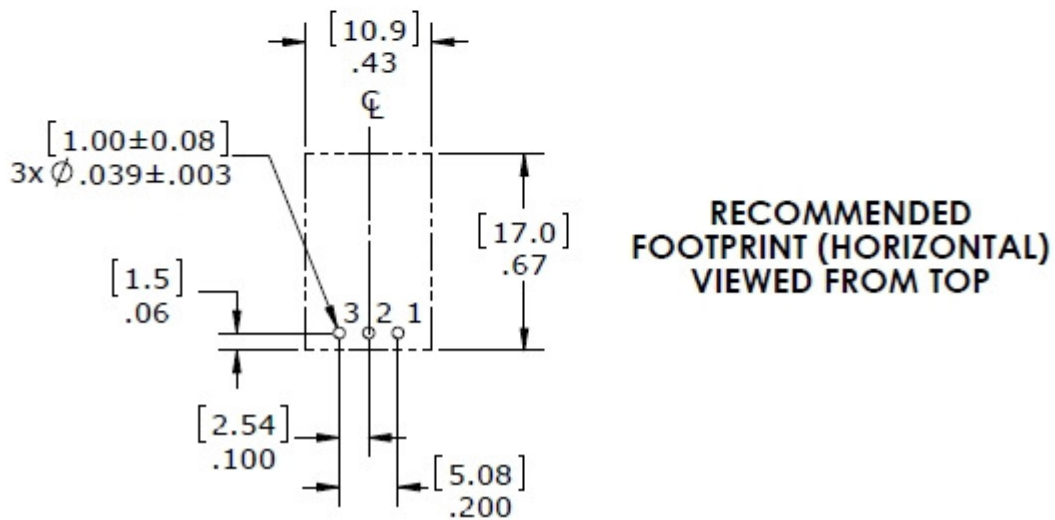
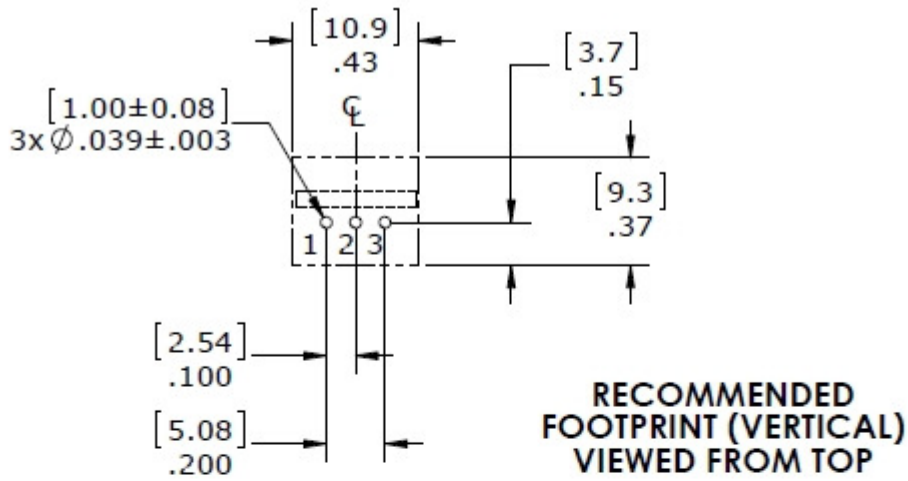

PACKAGING INFORMATION

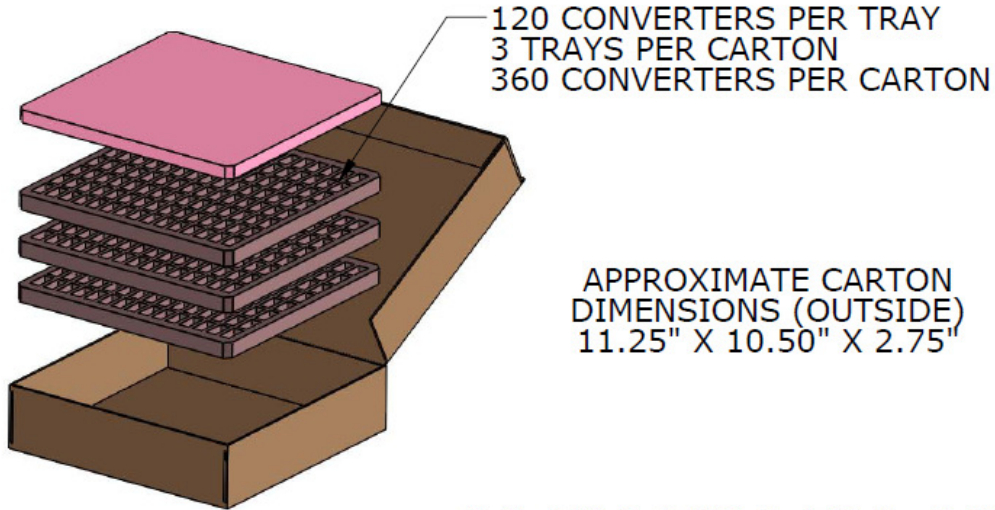

APPROXIMATE CARTON
DIMENSIONS (OUTSIDE)
11.25" X 10.50" X 2.75"

**PACKAGING FOR OKI-78
(VERTICAL)**

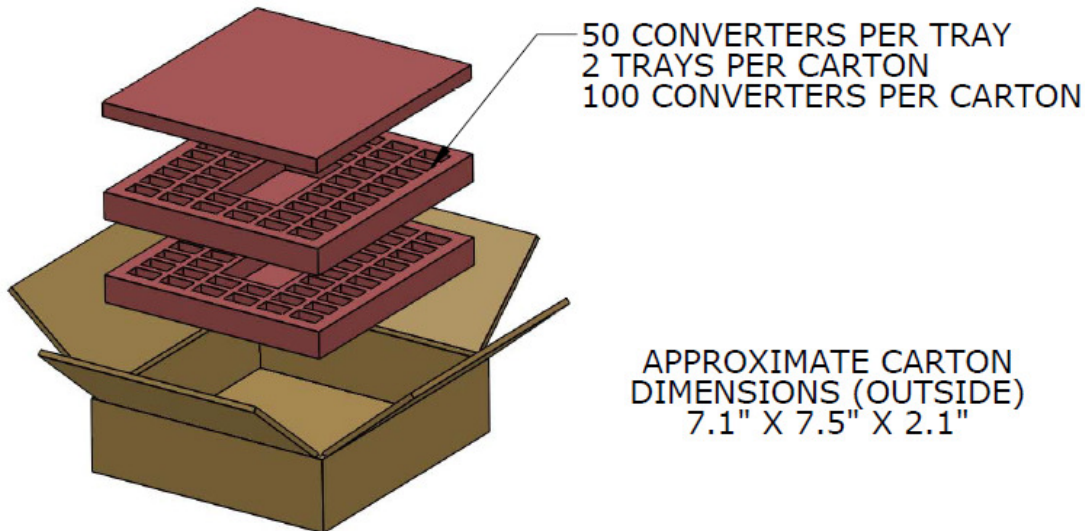

APPROXIMATE CARTON
DIMENSIONS (OUTSIDE)
7.1" X 7.5" X 2.1"

**PACKAGING FOR OKI-78
(HORIZONTAL)**

TECHNICAL NOTES

Input Fusing

Certain applications and/or safety agencies may require fuses at the inputs of power conversion components. Fuses should also be used when there is the possibility of sustained input voltage reversal which is not current-limited. For greatest safety, we recommend a fast blow fuse installed in the ungrounded input supply line.

The installer must observe all relevant safety standards and regulations. For safety agency approvals, install the converter in compliance with the end-user safety standard.

Recommended Input Filtering

The user must assure that the input source has low AC impedance to provide dynamic stability and that the input supply has little or no inductive content, including long distributed wiring to a remote power supply. The converter will operate with no additional external capacitance if these conditions are met.

For best performance, we recommend installing a low-ESR capacitor immediately adjacent to the converter's input terminals. The capacitor should be a ceramic type such as the Murata GRM32 series or a polymer type. Initial suggested capacitor values are 10 to 22 μF , rated at twice the expected maximum input voltage. Make sure that the input terminals do not go below the undervoltage shutdown voltage at all times. More input bulk capacitance may be added in parallel (either electrolytic or tantalum) if needed.

Recommended Output Filtering

The converter will achieve its rated output ripple and noise with no additional external capacitor. However, the user may install more external output capacitance to reduce the ripple even further or for improved dynamic response. Again, use low-ESR ceramic (Murata GRM32 series) or polymer capacitors. Initial values of 10 to 47 μF may be tried, either single or multiple capacitors in parallel. Mount these close to the converter. Measure the output ripple under your load conditions.

Use only as much capacitance as required to achieve your ripple and noise objectives. Excessive capacitance can make step load recovery sluggish or possibly introduce instability. Do not exceed the maximum rated output capacitance listed in the specifications.

Input Ripple Current and Output Noise

All models in this converter series are tested and specified for input reflected ripple current and output noise using designated external input/output components, circuits and layout as shown in the following figures. The Cbus and Lbus components simulate a typical DC voltage bus. Please note that the values of Cin, Lbus and Cbus will vary according to the specific converter model.

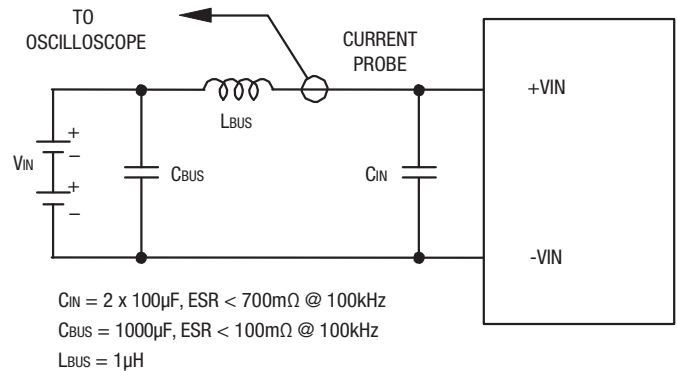

Figure 3 Measuring Input Ripple Current

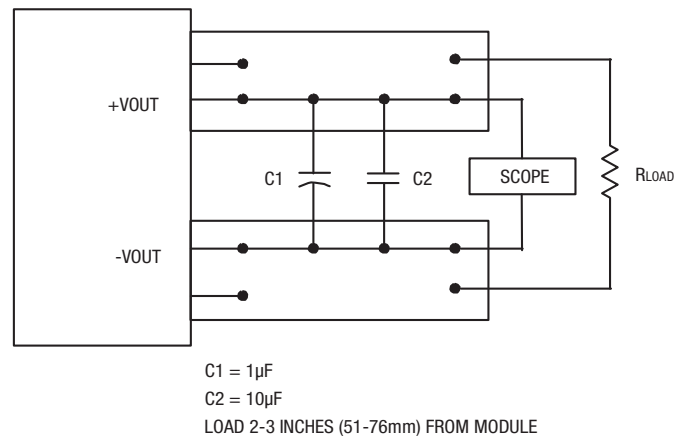

Figure 4. Measuring Output Ripple and Noise (PARD)

Minimum Output Loading Requirements

All models regulate within specification and are stable under no load to full load conditions. Operation under no load might however slightly increase output ripple and noise.

Temperature Derating Curves

The graphs in this data sheet illustrate typical operation under a variety of conditions. The Derating curves show the maximum continuous ambient air temperature and decreasing maximum output current which is acceptable under increasing forced airflow measured in Linear Feet per Minute (“LFM”). Note that these are AVERAGE measurements. The converter will accept brief increases in current or reduced airflow as long as the average is not exceeded.

Note that the temperatures are of the ambient airflow, not the converter itself which is obviously running at higher temperature than the outside air. Also note that “natural convection” is defined as very low rates which are not using fan-forced airflow. Depending on the application, “natural convection” is usually about 30-65 LFM but is not equal to still air (0 LFM).

Murata Power Solutions makes Characterization measurements in a closed cycle wind tunnel with calibrated airflow. We use both thermocouples and an infrared camera system to observe thermal performance. As a practical matter, it is quite difficult to insert an anemometer to precisely measure airflow in most applications. Sometimes it is possible to estimate the effective airflow if you thoroughly understand the enclosure geometry, entry/exit orifice areas and the fan flowrate specifications.

CAUTION: If you routinely or accidentally exceed these Derating guidelines, the converter may have an unplanned Over Temperature shut down. Also, these graphs are all collected at near Sea Level altitude. Be sure to reduce the derating for higher altitude.

Output Fusing

The converter is extensively protected against current, voltage and temperature extremes. However your output application circuit may need additional protection. In the extremely unlikely event of output circuit failure, excessive voltage could be applied to your circuit. Consider using an appropriate fuse in series with the output.

Output Current Limiting

Current limiting inception is defined as the point at which full power falls below the rated tolerance. See the Performance/Functional Specifications. Note particularly that the output current may briefly rise above its rated value in normal operation as long as the average output power is not exceeded. This enhances reliability and continued operation of your application. If the output current is too high, the converter will enter the short circuit condition.

Output Short Circuit Condition

When a converter is in current-limit mode, the output voltage will drop as the output current demand increases. If the output voltage drops too low (approximately 98% of nominal output voltage for most models), the bias voltage may shut down the PWM controller. Following a time-out period, the PWM will restart, causing the output voltage to begin rising to its appropriate value. If the short-circuit condition persists, another shutdown cycle will initiate. This rapid on/off cycling is called “hiccup mode”. The hiccup cycling reduces the average output current, thereby preventing excessive internal temperatures and/or component damage.

The “hiccup” system differs from older latching short circuit systems because you do not have to power down the converter to make it restart. The system will automatically restore operation as soon as the short circuit condition is removed.

Soldering Guidelines

Murata Power Solutions recommends the specifications below when installing these converters. These specifications vary depending on the solder type. Exceeding these specifications may cause damage to the product. Your production environment may differ; therefore please thoroughly review these guidelines with your process engineers.

Wave Solder Operations for through-hole mounted products (THMT)			
For Sn/Ag/Cu based solders:		For Sn/Pb based solders:	
Maximum Preheat Temperature	115° C.	Maximum Preheat Temperature	105° C.
Maximum Pot Temperature	270° C.	Maximum Pot Temperature	250° C.
Maximum Solder Dwell Time	7 seconds	Maximum Solder Dwell Time	6 seconds

Murata Power Solutions, Inc.
 11 Cabot Boulevard, Mansfield, MA 02048-1151 U.S.A.
 ISO 9001 and 14001 REGISTERED



This product is subject to the following operating requirements and the Life and Safety Critical Application Sales Policy:
 Refer to: <http://www.murata-ps.com/requirements/>

Murata Power Solutions, Inc. makes no representation that the use of its products in the circuits described herein, or the use of other technical information contained herein, will not infringe upon existing or future patent rights. The descriptions contained herein do not imply the granting of licenses to make, use, or sell equipment constructed in accordance therewith. Specifications are subject to change without notice.
 © 2017 Murata Power Solutions, Inc.