



### FEATURES

- Basic/supplementary isolation to UL 60950<sup>2</sup>
- UL60601 (3rd Ed) recognition<sup>2</sup>
- Single and dual outputs
- UL 94V-0 package material
- SIP package style
- 5.2kVDC isolation
- 3.3V, 5V, 12V, 15V & 24V inputs
- 3.3V, 5V, 9V, 12V & 15V output
- Internal SMD construction
- Fully encapsulated with toroidal magnetics
- Pin compatible with the MEV, NMV, NMK, MEJ2, & NMJ series

### PRODUCT OVERVIEW

The MEJ1 series are single and dual output DC/DC converters in a 7 pin SIP package style offering an isolation and insulation upgrade path from the NMV & MEV1 series<sup>1</sup>. The MEJ1 series has UL60950 and UL60601 recognition, which makes it ideal for applications where safety and miniaturisation are of paramount importance.

### SELECTION GUIDE

Order Code	Nominal Input Voltage	Output Voltage	Output Current	Input Current (Typ)	Load Regulation (Typ)	Load Regulation (Max)	Ripple & Noise (Typ) <sup>3</sup>	Ripple & Noise (Max) <sup>3</sup>	Efficiency (Min)	Efficiency (Typ)	MTTF		
	V	V	mA		%		mVp-p		%	kHrs			
Single	MEJ1S0303SC	3.3	3.3	303	410	8.5	11	42	55	67	70	3653	
	MEJ1S0305SC	3.3	5	200	400	9	10	33	45	68	71.5	3810	
	MEJ1S0503SC	5	3.3	303	280	6.5	8	20	40	66	69	4117	
	MEJ1S0505SC	5	5	200	270	5.5	7	24	40	68	72	4082	
	MEJ1S0509SC	5	9	111	265	4.5	5	20	40	70	74	3939	
	MEJ1S0512SC	5	12	83	260	4.5	7	22	40	71	74	3816	
	MEJ1S0515SC	5	15	66	260	5	6	22	40	72	75	3412	
	MEJ1S1203SC	12	3.3	303	110	6	7	25	45	69	72	3461	
	MEJ1S1205SC	12	5	200	110	5	6	21	40	71	74.5	3319	
	MEJ1S1209SC	12	9	111	105	4	5	18	40	73	76.5	3218	
	MEJ1S1212SC	12	12	83	105	3.5	5	19	40	73	76.5	3494	
	MEJ1S1215SC	12	15	66	105	4	5	16	40	73	77	3150	
	MEJ1S1505SC	15	5	200	90	5	6	23	45	70	74	3048	
	MEJ1S1509SC	15	9	111	85	4	5	18	40	72	76	2963	
	MEJ1S1512SC	15	12	83	85	4	5	20	40	72	76.5	2733	
	MEJ1S1515SC	15	15	66	85	4	5	19	35	73	76.5	2333	
	Dual	MEJ1D2405SC	24	5	200	55	5	6	23	40	71	75	3353
		MEJ1D2409SC	24	9	111	55	4	7	17	40	72	77	2940
MEJ1D2412SC		24	12	83	55	4	5	19	40	72	78	2987	
MEJ1D2415SC		24	15	66	55	3.5	5	17	40	74	78	2517	
MEJ1D0503SC		5	±3.3	±151	280	6	8	19	40	67	70	4511	
MEJ1D0505SC		5	±5	±100	275	5	6	23	35	69	72	4012	
MEJ1D0509SC		5	±9	±55	265	4	6	16	35	69	74	3492	
MEJ1D0512SC		5	±12	±42	260	4	5	15	30	72	74.5	3485	
MEJ1D0515SC		5	±15	±33	260	4	5	13	35	71	75.5	2844	
MEJ1D1203SC		12	±3.3	±151	110	5.5	6	19	40	70	73	3461	
MEJ1D1205SC		12	±5	±100	110	4.5	5	18	40	72	75.5	3317	
MEJ1D1209SC		12	±9	±55	110	4	5	15	35	73	77	2908	
MEJ1D1212SC		12	±12	±42	110	3.5	5	14	30	74	76.5	2911	
MEJ1D1215SC		12	±15	±33	110	4	5	11	35	73	77	2713	
MEJ1D1505SC		15	±5	±100	90	4.5	5	19	40	72	75	3274	
MEJ1D1509SC		15	±9	±55	85	4	5	14	35	73	76.5	3229	
MEJ1D1512SC		15	±12	±42	85	3.5	5	13	35	73	77	2872	
MEJ1D1515SC		15	±15	±33	85	3.5	5	20	35	73	76.5	2440	
MEJ1D2405SC	24	±5	±100	55	4.5	5	19	40	72	76.5	3316		
MEJ1D2409SC	24	±9	±55	55	3.5	5	17	35	73	78	3208		
MEJ1D2412SC	24	±12	±42	55	3.5	5	12	35	74	78	3362		
MEJ1D2415SC	24	±15	±33	55	3.5	5	14	35	74	78.5	2697		

### INPUT CHARACTERISTICS

Parameter	Conditions	Min.	Typ.	Max.	Units
Voltage range	Continuous operation, 3V input types	2.97	3.3	3.63	V
	Continuous operation, 5V input types	4.5	5	5.5	
	Continuous operation, 12V input types	10.8	12	13.2	
	Continuous operation, 15V input types	13.5	15	16.5	
	Continuous operation, 24V input types	21.6	24	26.4	
Input reflected ripple	3.3V input types		40		mA
	5V input types		24		
	12V & 15V input types		12		
	24V input types		8		

1. Calculated using MIL-HDBK-217 FN2 calculation model with nominal input voltage at full load.

2. See safety approvals section for limitations of use.

3. See ripple & noise test method.

All specifications typical at T<sub>a</sub>=25°C, nominal input voltage and rated output current unless otherwise specified.



### OUTPUT CHARACTERISTICS

Parameter	Conditions	Min.	Typ.	Max.	Units
Rated Power <sup>2</sup>	T <sub>A</sub> =-40°C to 85°C			1	W
Voltage Set Point Accuracy	See tolerance envelopes				
Line regulation	High V <sub>IN</sub> to low V <sub>IN</sub>		1.1	1.2	%/%

### ABSOLUTE MAXIMUM RATINGS

Short-circuit protection	48 Hours
Lead temperature 1mm from case for 10 seconds	260°C
Input voltage V <sub>IN</sub> , MEJ1x03xxSC	5V
Input voltage V <sub>IN</sub> , MEJ1x05xxSC	7V
Input voltage V <sub>IN</sub> , MEJ1x12xxSC	15V
Input voltage V <sub>IN</sub> , MEJ1x15xxSC	18V
Input voltage V <sub>IN</sub> , MEJ1x24xxSC	28V

### ISOLATION CHARACTERISTICS

Parameter	Conditions	Min.	Typ.	Max.	Units
Isolation test voltage	Flash tested for 1 second	5200			VDC
Resistance	Viso= 500VDC		1		GΩ
Isolation capacitance			3		pF

### GENERAL CHARACTERISTICS

Parameter	Conditions	Min.	Typ.	Max.	Units
Switching frequency	All types		50		kHz

### TEMPERATURE CHARACTERISTICS

Parameter	Conditions	Min.	Typ.	Max.	Units
Specification	All output types (see safety approval section for limitations)	-40		85	°C
Storage		-55		125	
Case Temperature above ambient	MEJ1S1212SC, MEJ1S1512SC, MEJ1S2412SC, MEJ1D1215SC, MEJ1D1512SC, MEJ1D2412SC, MEJ1D2415SC, MEJ1S1215SC, MEJ1S1509SC, MEJ1S2409SC MEJ1D1205SC, MEJ1D1209SC, MEJ1D2405SC, MEJ1D2409SC, MEJ1S1209SC, MEJ1S1515SC, MEJ1S2415SC, MEJ1D1212SC, MEJ1D1509SC, MEJ1S0515SC, MEJ1S2405SC, MEJ1D0512SC, MEJ1D0515SC, MEJ1D1515SC, MEJ1S1505SC, MEJ1D0505SC, MEJ1D0509SC, MEJ1D1203SC, MEJ1D1505SC, MEJ1S0509SC, MEJ1S0512SC, MEJ1S1205SC MEJ1S0505SC, MEJ1S1203SC, MEJ1D0503SC, MEJ1S0303SC, MEJ1S0305SC, MEJ1S0503SC		13 17 21		
Cooling	Free air convection				

### TEMPERATURE DERATING GRAPH

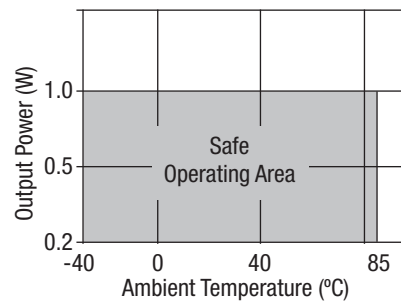

**TECHNICAL NOTES****ISOLATION VOLTAGE**

'Hi Pot Test', 'Flash Tested', 'Withstand Voltage', 'Proof Voltage', 'Dielectric Withstand Voltage' & 'Isolation Test Voltage' are all terms that relate to the same thing, a test voltage, applied for a specified time, across a component designed to provide electrical isolation, to verify the integrity of that isolation.

Murata Power Solutions MEJ1 series of DC/DC converters are all 100% production tested at their stated isolation voltage. This is 5.2kVDC for 1 second.

A question commonly asked is, "What is the continuous voltage that can be applied across the part in normal operation?"

The MEJ1 series has been recognized by Underwriters Laboratory for various voltages, please see safety approval section below.

**REPEATED HIGH-VOLTAGE ISOLATION TESTING**

It is well known that repeated high-voltage isolation testing of a barrier component can actually degrade isolation capability, to a lesser or greater degree depending on materials, construction and environment. We therefore strongly advise against repeated high voltage isolation testing, but if it is absolutely required, that the voltage be reduced by 20% from specified test voltage.

**SAFETY APPROVAL****UL 60601**

The MEJ1 series has been recognized by Underwriters Laboratory (UL) to the 3rd edition of 60601 and provides the following MOOP (means of operator protection), in a maximum ambient temperature of 85°C and/or case temperature limit of 130°C (case temperature measured on the face opposite the pins): 2 MOOP based upon a working voltage of 200 Vrms max. and 280 Vpkmax., between Primary and Secondary and 1 MOOP based upon a working voltage of 200 Vrms max., between Primary and its Enclosure. File Number E202895 applies.

**UL 60950**

The MEJ1 series has been recognized by Underwriters Laboratory (UL) to UL 60950 for basic/supplementary insulation to a working voltage of 200Vrms in a maximum ambient temperature of 85°C and/or case temperature limit of 130°C (case temperature measured on the face opposite the pins). File number E151252 applies.

**FUSING**

The MEJ1 Series of converters are not internally fused so to meet the requirements of UL an anti-surge input line fuse should always be used with ratings as defined below.

MEJ1x03xxSC 1A

MEJ1x05xxSC 1A

MEJ1x12xxSC 500mA

MEJ1x15xxSC 500mA

MEJ1x24xxSC 250mA

All fuses should be UL recognized and rated to at least the maximum allowable DC input voltage.

**RoHS COMPLIANCE INFORMATION**

This series is compatible with RoHS soldering systems with a peak wave solder temperature of 260°C for 10 seconds. The pin termination finish on this product series is Tin Plate, Hot Dipped over Matte Tin with Nickel Preplate. The series is backward compatible with Sn/Pb soldering systems. For further information, please visit [www.murata-ps.com/rohs](http://www.murata-ps.com/rohs)

**APPLICATION NOTES**

**Minimum load**

The minimum load to meet datasheet specification is 10% of the full rated load across the specified input voltage range. Lower than 10% minimum loading will result in an increase in output voltage, which may rise to typically double the specified output voltage if the output load falls to less than 5%.

**Capacitive loading and start up**

Typical start up times for this series, with a typical input voltage rise time of 2.2µs and output capacitance of 10µF, are shown in the table below. The product series will start into a capacitance of 47µF with an increased start time, however, the maximum recommended output capacitance is 10µF.

Start-up time		Start-up time	
µs		µs	
MEJ1S0303SC	900	MEJ1D0503SC	700
MEJ1S0305SC	2000	MEJ1D0505SC	1600
MEJ1S0503SC	500	MEJ1D0509SC	3700
MEJ1S0505SC	2000	MEJ1D0512SC	4200
MEJ1S0509SC	3200	MEJ1D0515SC	7000
MEJ1S0512SC	7500	MEJ1D1203SC	600
MEJ1S0515SC	10500	MEJ1D1205SC	1200
MEJ1S1203SC	600	MEJ1D1209SC	3600
MEJ1S1205SC	1200	MEJ1D1212SC	3900
MEJ1S1209SC	2900	MEJ1D1215SC	6000
MEJ1S1212SC	2900	MEJ1D1505SC	1200
MEJ1S1215SC	3900	MEJ1D1509SC	3200
MEJ1S1505SC	1100	MEJ1D1512SC	3300
MEJ1S1509SC	2400	MEJ1D1515SC	4800
MEJ1S1512SC	2700	MEJ1D2405SC	1100
MEJ1S1515SC	3800	MEJ1D2409SC	2000
MEJ1S2405SC	1700	MEJ1D2412SC	3300
MEJ1S2409SC	2300	MEJ1D2415SC	6400
MEJ1S2412SC	2200		
MEJ1S2415SC	3600		

Typical Start-Up Wave Form

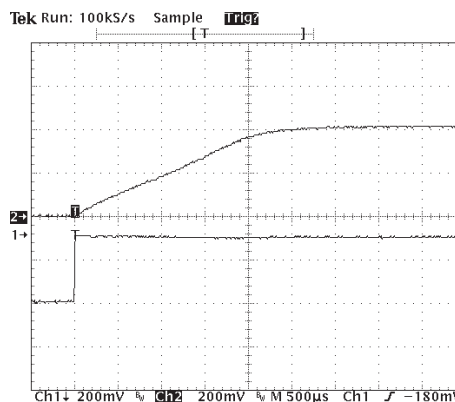

**Ripple & Noise Characterisation Method**

Ripple and noise measurements are performed with the following test configuration.

C1	1µF X7R multilayer ceramic capacitor, voltage rating to be a minimum of 3 times the output voltage of the DC/DC converter
C2	10µF tantalum capacitor, voltage rating to be a minimum of 1.5 times the output voltage of the DC/DC converter with an ESR of less than 100mΩ at 100 kHz
C3	100nF multilayer ceramic capacitor, general purpose
R1	450Ω resistor, carbon film, ±1% tolerance
R2	50Ω BNC termination
T1	3T of the coax cable through a ferrite toroid
RLOAD	Resistive load to the maximum power rating of the DC/DC converter. Connections should be made via twisted wires

Measured values are multiplied by 10 to obtain the specified values.

**Differential Mode Noise Test Schematic**

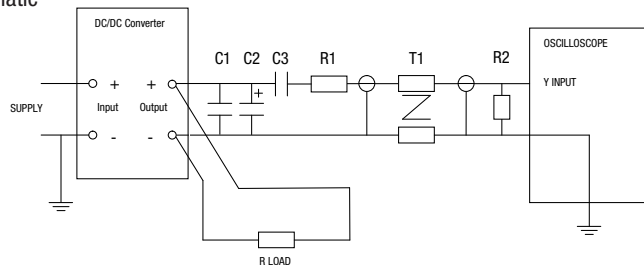

**TOLERANCE ENVELOPES**

The voltage tolerance envelope shows typical load regulation characteristics for this product series. The tolerance envelope is the maximum output voltage variation due to changes in output loading.

**DUAL 1203,1515, 2412, SINGLE 0303, 0305, 1203**

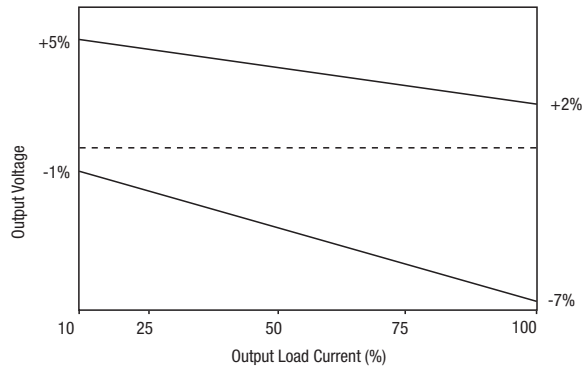

**DUAL 1209, 1509, 2409**

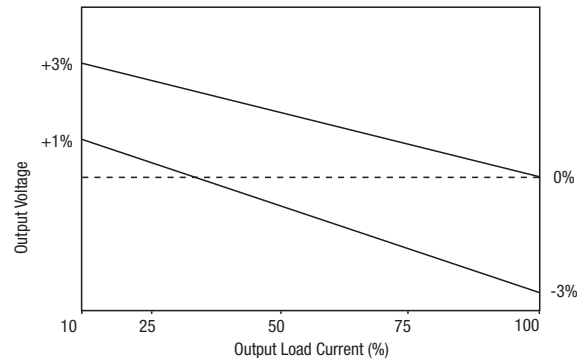

**DUAL 0515, SINGLE 1515, 2415**

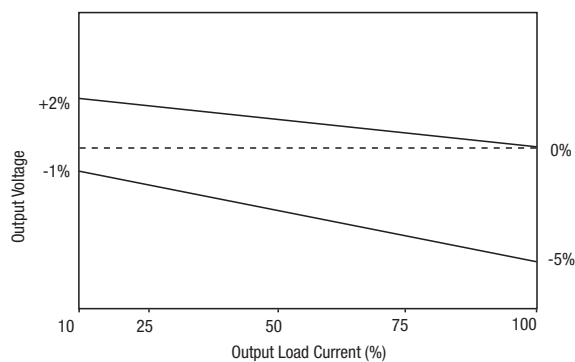

**DUAL 1512, SINGLE 1212, 1512, 2412**

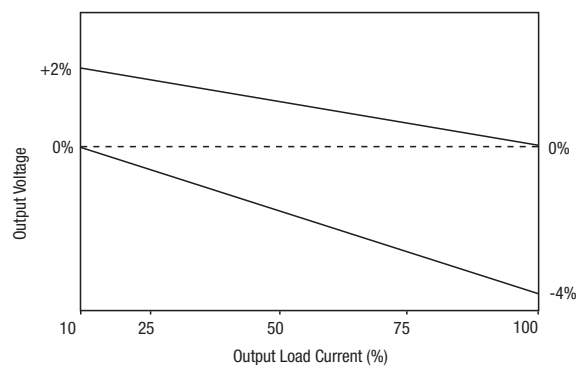

**DUAL 0512, SINGLE 1209, 1509,**

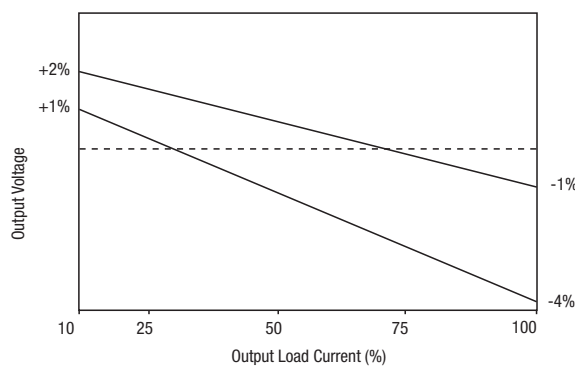

**DUAL 1212, 1215, 2415, SINGLE 0509, 0512, 1215, 2409**



## TOLERANCE ENVELOPES

**SINGLE 1205, 1505, 2405, 0515**



**DUAL 1205, 0505, 1505, 2405**



**DUAL 0509, 0503, SINGLE 0503, 0505**



### EFFICIENCY VS LOAD Single Output

#### 3.3V Input

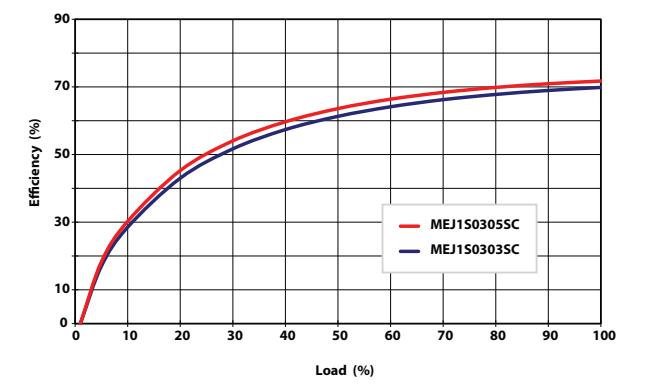

#### 5V Input

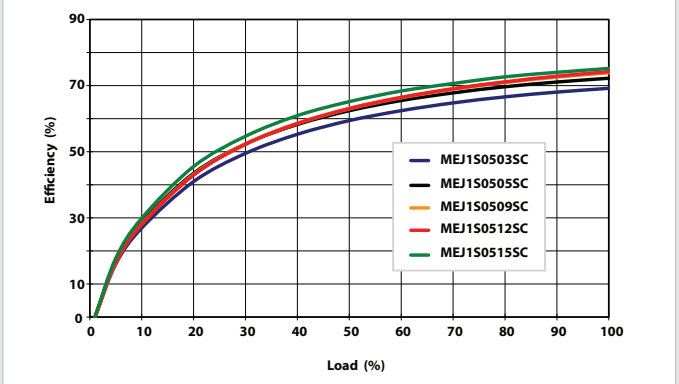

#### 12V Input

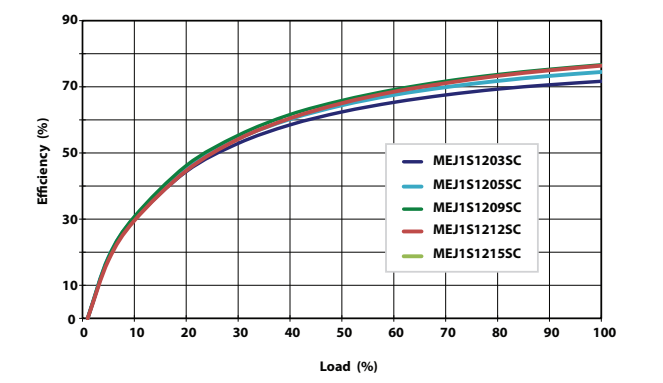

#### 15V Input

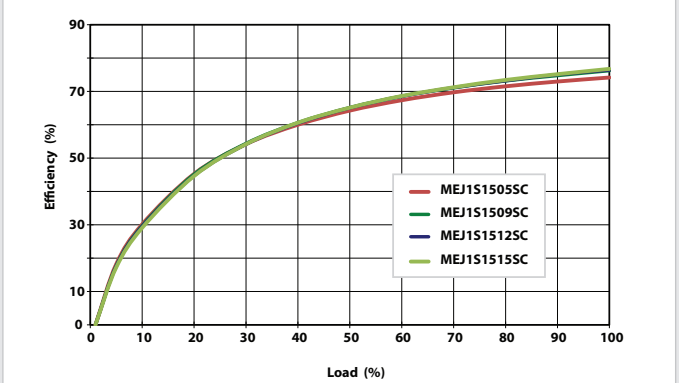

#### 24V Input

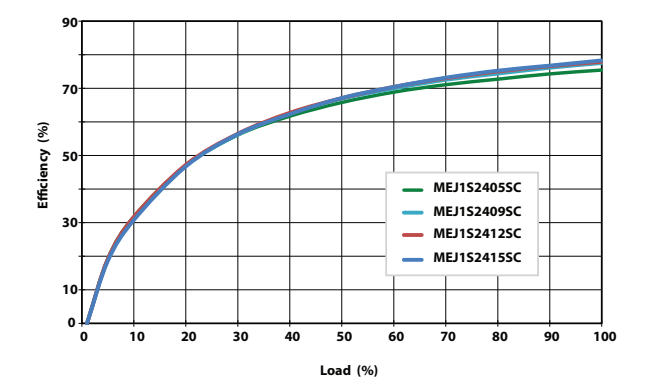

## EFFICIENCY VS LOAD Dual Output

### 5V Input

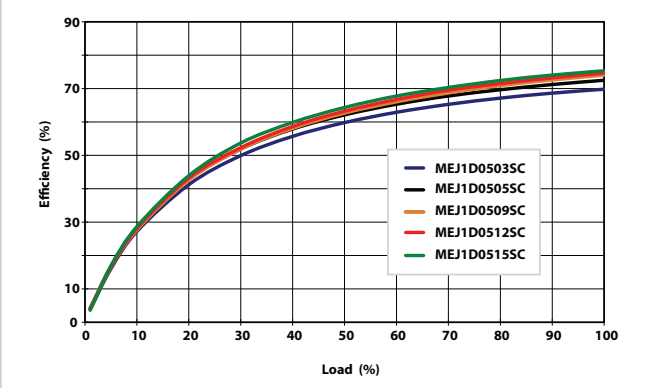

### 12V Input



### 15V Input

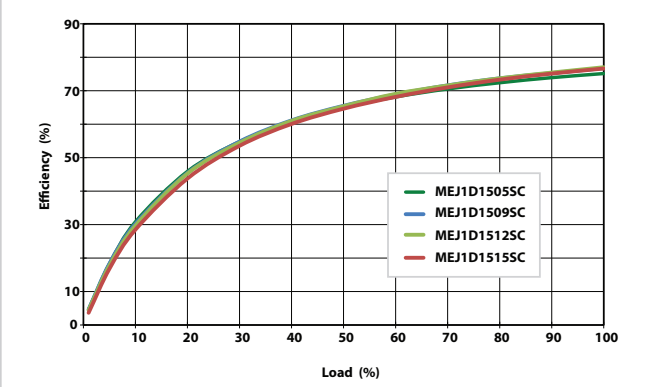

### 24V Input





### PACKAGE SPECIFICATIONS

#### MECHANICAL DIMENSIONS

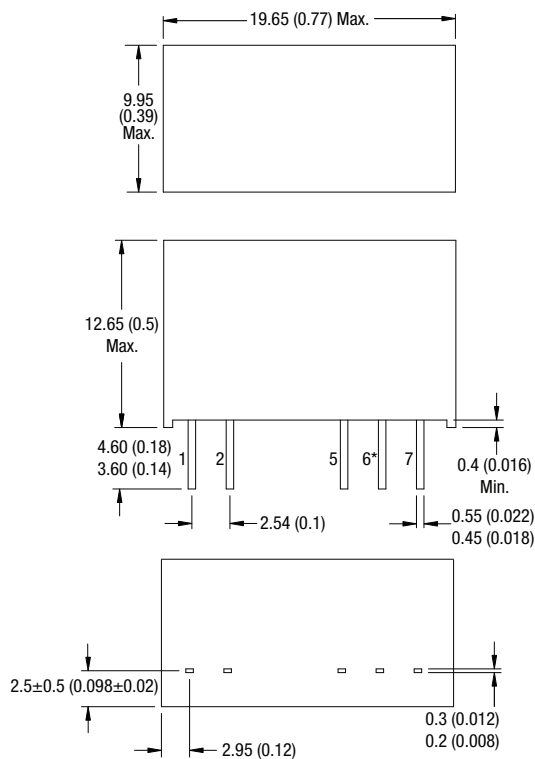

All dimensions in mm ±0.25mm (inches ±0.01). All pins on a 2.54 (0.1) pitch and within ±0.25 (0.01) of true position.  
 \* Pin not fitted on single output variants. Weight: 4.3g

#### PIN CONNECTIONS

##### Dual Output

Pin	Function
1	+V <sub>IN</sub>
2	-V <sub>IN</sub>
5	-V <sub>OUT</sub>
6	OV
7	+V <sub>OUT</sub>

##### Single Output

Pin	Function
1	+V <sub>IN</sub>
2	-V <sub>IN</sub>
5	-V <sub>OUT</sub>
7	+V <sub>OUT</sub>

#### RECOMMENDED FOOTPRINT DETAILS

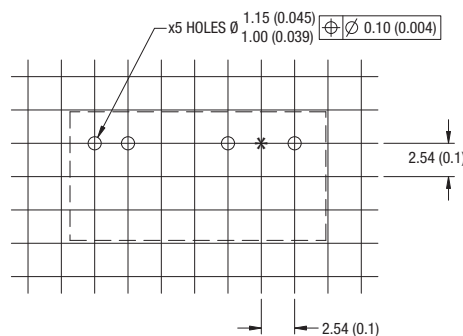

\* Hole not required for single output variants.  
 All dimensions in inches ±0.01 (mm ±0.25mm).

#### TUBE OUTLINE DIMENSIONS

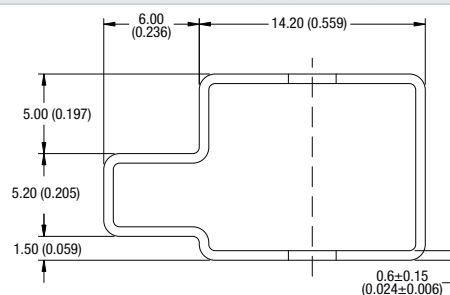

Unless otherwise stated all dimensions in inches ±0.02 (mm ±0.5mm).  
 Tube length : 20.669 ± 0.079 (525mm ± 2mm). Tube Quantity : 25

Murata Power Solutions, Inc.  
 11 Cabot Boulevard, Mansfield, MA 02048-1151 U.S.A.  
 ISO 9001 and 14001 REGISTERED



This product is subject to the following [operating requirements](#) and the [Life and Safety Critical Application Sales Policy](#):  
 Refer to: <http://www.murata-ps.com/requirements/>

Murata Power Solutions, Inc. makes no representation that the use of its products in the circuits described herein, or the use of other technical information contained herein, will not infringe upon existing or future patent rights. The descriptions contained herein do not imply the granting of licenses to make, use, or sell equipment constructed in accordance therewith. Specifications are subject to change without notice. © 2013 Murata Power Solutions, Inc.