

## FEATURES

- UL 60950 recognised<sup>4</sup>
- Single Isolated output
- 1kVDC or 3kVDC option 'Hi Pot Test'
- Wide temperature performance at full 1W load -40°C to 85°C<sup>3</sup>
- Industry Standard Pinout
- 3.3V, 5V, 12V & 24V Inputs
- 5V, 12V & 15V outputs
- Pin Compatible with CME, CRL2, LME, MEE1, MEE3, MTE1, NKE, NME, NML & NTE series
- Through hole and surface mount options available

## PRODUCT OVERVIEW

The CRE1 series are a cost effective 1W DC/DC converter series, in industry standard packages with industry standard pinout. Popular input and output voltages are available. The galvanic isolation allows the device to be configured to provide an isolated negative rail in systems where only positive rails exist. The wide temperature range guarantees startup from -40°C and full 1 watt output at 85°C<sup>3</sup>.

## SELECTION GUIDE

| Order Code <sup>1</sup>        | Nominal Input Voltage | Output Voltage | Output Current | Load Regulation |      | Ripple & Noise |        | Input Current at Rated Load | Efficiency |      | Isolation Capacitance | MTTF <sup>2</sup> |      |
|--------------------------------|-----------------------|----------------|----------------|-----------------|------|----------------|--------|-----------------------------|------------|------|-----------------------|-------------------|------|
|                                |                       |                |                | %               | %    | mV p-p         | mV p-p |                             | %          | %    |                       | MIL               | Tel. |
|                                | V                     | V              | mA             | Typ.            | Max. | Typ.           | Max.   | mA                          | Min.       | Typ. | pF                    | kHrs              | kHrs |
| CRE1S0505DC                    | 5                     | 5              | 200            | 12              | 14   | 16             | 40     | 286                         | 65         | 70   | 30                    |                   |      |
| CRE1S0505SC                    | 5                     | 5              | 200            | 12              | 14   | 16             | 40     | 286                         | 65         | 70   | 30                    |                   |      |
| CRE1S0515SC                    | 5                     | 15             | 67             | 6               | 7.5  | 10             | 25     | 250                         | 77         | 80   | 40                    |                   |      |
| CRE1S1205SC                    | 12                    | 5              | 200            | 8               | 10   | 12             | 30     | 117                         | 68         | 71   | 33                    |                   |      |
| CRE1S1212SC                    | 12                    | 12             | 83             | 4               | 5    | 8              | 20     | 104                         | 75         | 80   | 55                    |                   |      |
| CRE1S2405SC                    | 24                    | 5              | 200            | 8.5             | 10   | 13             | 30     | 58                          | 67         | 71   | 40                    |                   |      |
| CRE1S2412SC                    | 24                    | 12             | 83             | 3               | 4    | 10             | 25     | 52                          | 75         | 80   | 78                    |                   |      |
| <b>3KVDC isolation options</b> |                       |                |                |                 |      |                |        |                             |            |      |                       |                   |      |
| CRE1S0305S3C                   | 3.3                   | 5              | 200            | 10              | 12   | 15             | 25     | 400                         | 72         | 75   | 35                    |                   |      |
| CRE1S0505S3C                   | 5                     | 5              | 200            | 6               | 8    | 15             | 25     | 250                         | 73         | 77   | 24                    |                   |      |
| <b>Surface mount options</b>   |                       |                |                |                 |      |                |        |                             |            |      |                       |                   |      |
| CRE1S0505MC                    | 5                     | 5              | 200            | 12.8            | 15   | 62             | 85     | 294                         |            | 68   | 35                    | 6857              |      |
| CRE1S0505MEC                   | 5                     | 5              | 200            | 6.5             | 8    | 25             | 70     | 239                         | 79         | 82   | 22                    | 3041              |      |

## INPUT CHARACTERISTICS

| Parameter                | Conditions                             | Min. | Typ. | Max. | Units  |
|--------------------------|--|------|------|------|--------|
| Voltage range            | Continuous operation, 3.3V input types | 2.97 | 3.3  | 3.63 | V      |
|                          | Continuous operation, 5V input types   | 4.5  | 5.0  | 5.5  |        |
|                          | Continuous operation, 12V input types  | 10.8 | 12   | 13.2 |        |
|                          | Continuous operation, 24V input types  | 21.6 | 24   | 26.4 |        |
| Reflected ripple current | 3.3V & 12V input types                 |      | 1    | 15   | mA p-p |
|                          | 5V & 24V input types                   |      | 2    | 15   |        |
|                          | CRE1S0505MC                            |      | 30   | 47   |        |
|                          | CRE1S0505MEC                           |      | 5    | 15   |        |

## OUTPUT CHARACTERISTICS

| Parameter                  | Conditions                                  | Min. | Typ. | Max. | Units |
|----------------------------|---|------|------|------|-------|
| Rated Power                | T <sub>A</sub> =-40°C to 85°C <sup>3</sup>  |      |      | 1    | W     |
| Voltage Set Point Accuracy | See tolerance envelope                      |      |      |      |       |
| Line regulation            | High V <sub>IN</sub> to low V <sub>IN</sub> |      | 1.1  | 1.2  | %/%   |

## ISOLATION CHARACTERISTICS

| Parameter              | Conditions                            | Min. | Typ. | Max. | Units |
|------------------------|---------------------------------------|------|------|------|-------|
| Isolation test voltage | C Versions Flash tested for 1 second  | 1000 |      |      | VDC   |
|                        | 3C Versions Flash tested for 1 second | 3000 |      |      |       |
| Resistance             | Viso= 1000VDC                         |      | 10   |      | GΩ    |

## GENERAL CHARACTERISTICS

| Parameter           | Conditions       | Min. | Typ. | Max. | Units |
|---------------------|------------------|------|------|------|-------|
| Switching frequency | 3.3V input types |      | 115  |      | kHz   |
|                     | 5V input types   |      | 110  |      |       |
|                     | 12V input types  |      | 145  |      |       |
|                     | 24V input types  |      | 100  |      |       |
|                     | CRE1S0505MEC     |      | 80   |      |       |

1. If components are required in tape and reel format suffix order code with -R, e.g. CRE1S0505MC-R.
2. Calculated using MIL-HDBK-217 FN2 and Telcordia SR-332 calculation model with nominal input voltage at full load.
3. 24V input parts prior to date code D1635 have operating temperature range of 0 to 70°C.
4. UL 60950 recognition does not apply to the surface mount options.

All specifications typical at T<sub>A</sub>=25°C, nominal input voltage and rated output current unless otherwise specified.



For full details go to [www.murata-ps.com/rohs](http://www.murata-ps.com/rohs)



## ABSOLUTE MAXIMUM RATINGS

|   |       |
|---|-------|
| Lead temperature 1.5mm from case for 10 seconds | 260°C |
| Input voltage $V_{IN}$ , 3.3V input             | 5.5V  |
| Input voltage $V_{IN}$ , 5V input               | 7V    |
| Input voltage $V_{IN}$ , 12V input              | 15V   |
| Input voltage $V_{IN}$ , 24V input              | 28V   |

## TEMPERATURE CHARACTERISTICS

| Parameter                           | Conditions                    | Min. | Typ. | Max. | Units |
|-------------------------------------|-------------------------------|------|------|------|-------|
| Specification                       | All output types <sup>1</sup> | -40  |      | 85   | °C    |
| Storage                             |                               | -50  |      | 130  |       |
| Case temperature rise above ambient | 5V output types               |      |      | 41   |       |
|                                     | All other output types        |      |      | 32   |       |
|                                     | CRE1S0505MC                   |      | 43   |      |       |
|                                     | CRE1S0505MEC                  |      | 12.5 |      |       |
| Cooling                             | Free air convection           |      |      |      |       |

## TECHNICAL NOTES

### ISOLATION VOLTAGE

'Hi Pot Test', 'Flash Tested', 'Withstand Voltage', 'Proof Voltage', 'Dielectric Withstand Voltage' & 'Isolation Test Voltage' are all terms that relate to the same thing, a test voltage, applied for a specified time, across a component designed to provide electrical isolation, to verify the integrity of that isolation.

Murata Power Solutions CRE1 series of DC/DC converters are all 100% production tested at their stated isolation voltage. This is 1kVDC for 1 second for C versions and 3kVDC for 3C versions.

A question commonly asked is, "What is the continuous voltage that can be applied across the part in normal operation?"

The CRE1 series, through hole variants (excluding surface mount variants) have been recognised by Underwriters Laboratory for functional insulation, both input and output should normally be maintained within SELV limits i.e. less than 42.4V peak, or 60VDC. The isolation test voltage represents a measure of immunity to transient voltages and the part should never be used as an element of a safety isolation system. The part could be expected to function correctly with several hundred volts offset applied continuously across the isolation barrier; but then the circuitry on both sides of the barrier must be regarded as operating at an unsafe voltage and further isolation/insulation systems must form a barrier between these circuits and any user-accessible circuitry according to safety standard requirements.

### REPEATED HIGH-VOLTAGE ISOLATION TESTING

It is well known that repeated high-voltage isolation testing of a barrier component can actually degrade isolation capability, to a lesser or greater degree depending on materials, construction and environment. The CRE1 series has toroidal isolation transformers, with no additional insulation between primary and secondary windings of enameled wire. While parts can be expected to withstand several times the stated test voltage, the isolation capability does depend on the wire insulation. Any material, including this enamel (typically polyurethane) is susceptible to eventual chemical degradation when subject to very high applied voltages thus implying that the number of tests should be strictly limited. We therefore strongly advise against repeated high voltage isolation testing, but if it is absolutely required, that the voltage be reduced by 20% from specified test voltage.

This consideration equally applies to agency recognized parts rated for better than functional isolation where the wire enamel insulation is always supplemented by a further insulation system of physical spacing or barriers.

## SAFETY APPROVAL

The CRE1 series has been recognised by Underwriters Laboratory (UL) to UL 60950 for functional insulation in a maximum still air ambient temperature of 100°C for the C versions and 130°C for the 3C versions as measured on the case of the unit (hotspot). The CRE1 series surface mount versions are not currently UL recognised.

The CRE1 series of converters are not internally fused so to meet the requirements of UL 60950 an anti-surge input line fuse should always be used with ratings as defined below.

CRE1S03xxS3C: 0.9A

CRE1S05xxxxC: 0.5A

CRE1S12xxSC: 0.2A

CRE1S24xxSC: 0.1A

All fuses should be UL recognised, 125V rated.

File number E151252 applies.

1. 24V input parts prior to date code D1635 have operating temperature range of 0 to 70°C.

**TEMPERATURE DERATING GRAPH - Surface Mount & 3C types**

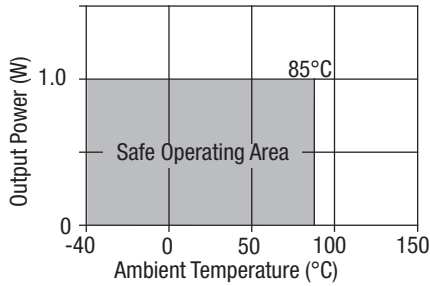

**TEMPERATURE DERATING GRAPH - All other types<sup>1</sup>**

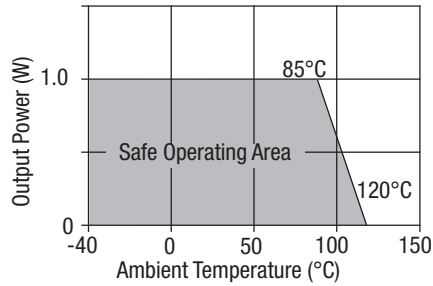

**EFFICIENCY VS LOAD**

**3.3V Inputs**

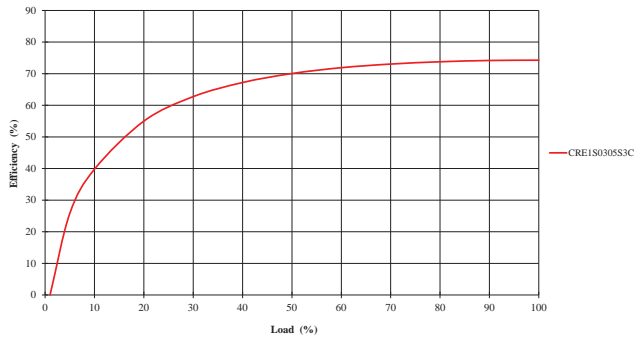

**5V Inputs**

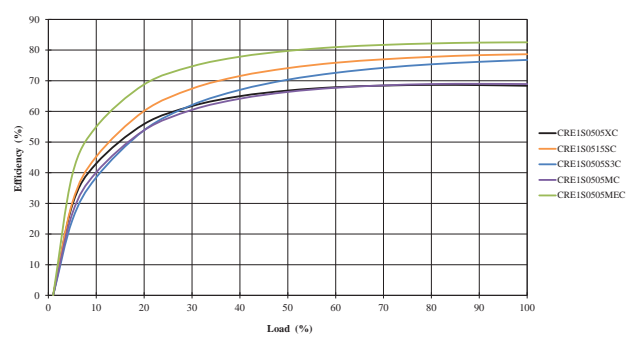

**12V Inputs**

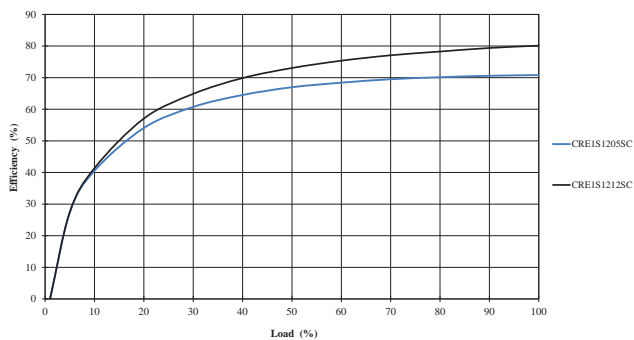

**24V Inputs**

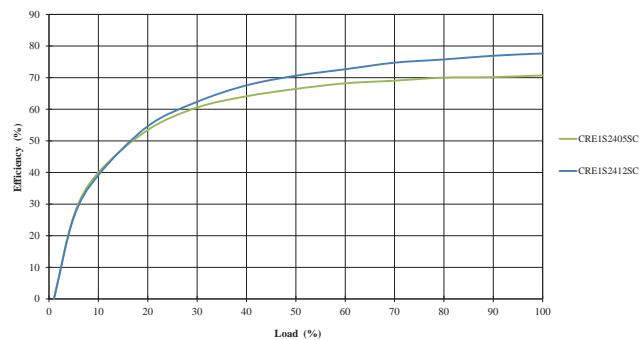

1. 24V input parts prior to date code D1635 have operating temperature range of 0 to 70°C.

## TOLERANCE ENVELOPES

The voltage tolerance envelope shows typical load regulation characteristics for this product series. The tolerance envelope is the maximum output voltage variation due to changes in output loading.

**CRE1S0505XC**

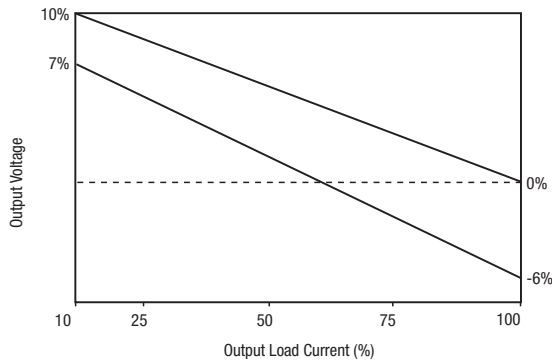

**CRE1S0515SC**

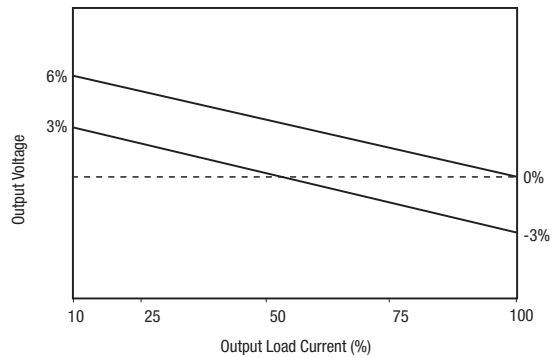

**CRE1S1205SC**

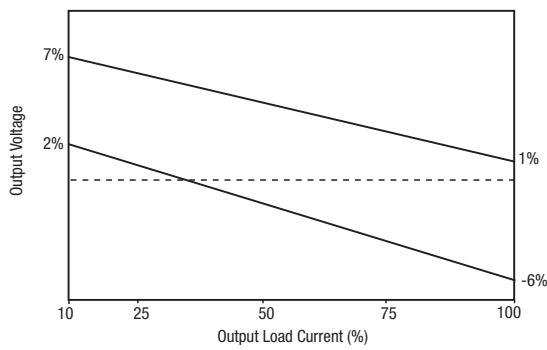

**CRE1S1212SC**

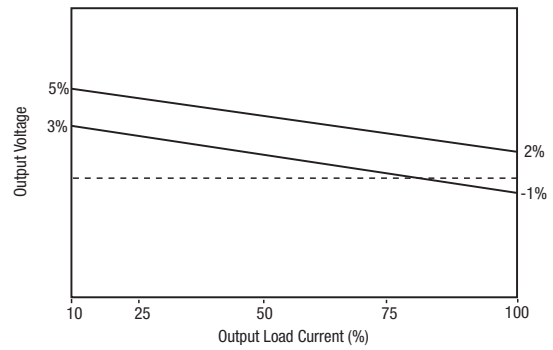

**CRE1S2405SC**

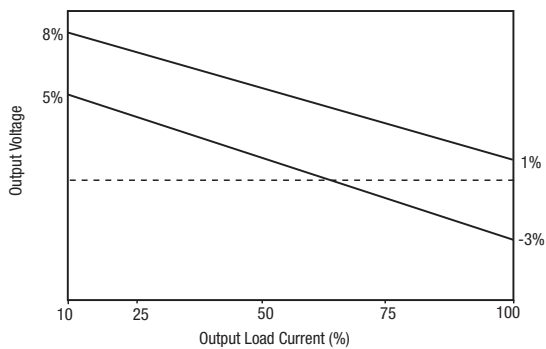

**CRE1S2412SC**

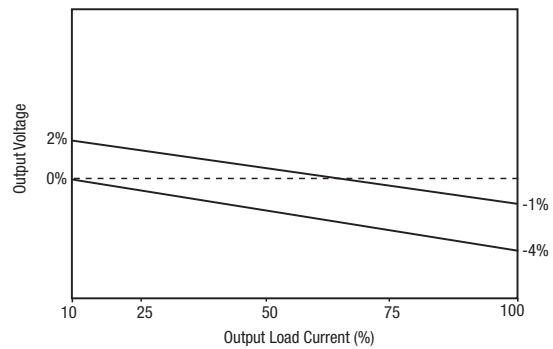

**TOLERANCE ENVELOPES (continued)**

**CRE1S0305S3C**

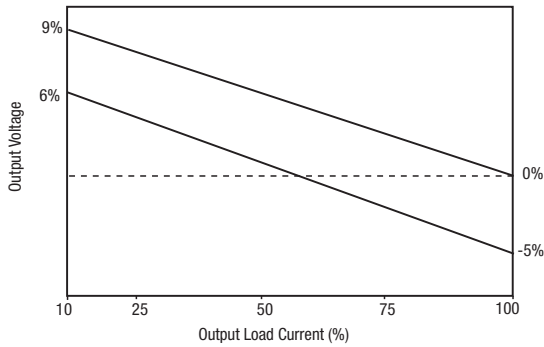

**CRE1S0505S3C**

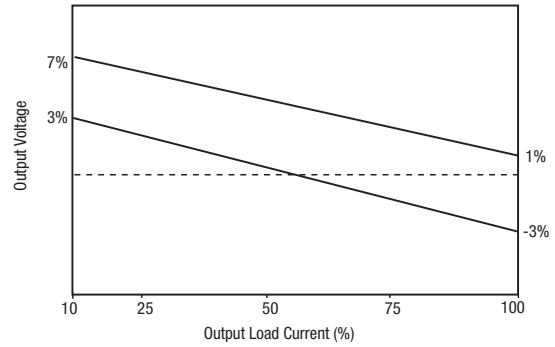

**CRE1S0505MC**

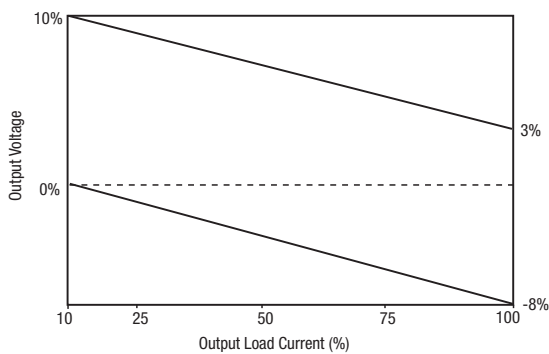

**CRE1S0505MEC**

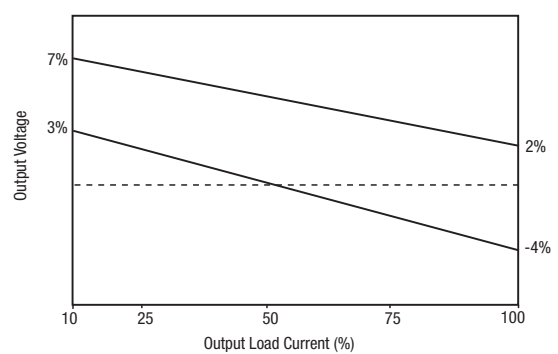

**RoHS COMPLIANCE and MSL INFORMATION**



The Through Hole parts (SIP/DIP) in this series are compatible with RoHS soldering systems with a peak wave solder temperature of 260°C for 10 seconds. The pin termination finish on the SIP package type is Tin Plate, Hot Dipped over Matte Tin with Nickel Preplate. The DIP types are Matte Tin over Nickel Preplate. This series is backward compatible with Sn/Pb soldering systems.

The Surface Mount parts (MC/MEC) in this series are compatible with RoHS soldering systems as per J-STD-020D.1 The pin termination finish on the Surface Mount package types is Matte Tin over Nickel Preplate. This series is backward compatible with Sn/Pb soldering systems. The Surface Mount parts have a Moisture Sensitivity Level (MSL) 1.

Samples of the Surface Mount parts were tested in accordance with the conditioning described for MSL level 1 in IDC/J-STD-020D.1. The products passed electrical tests and visual inspection criteria.

For further information, please visit [www.murata-ps.com/rohs](http://www.murata-ps.com/rohs)

## APPLICATION NOTES

### Minimum load

The minimum load to meet datasheet specification is 10% of the full rated load across the specified input voltage range. Lower than 10% minimum loading will result in an increase in output voltage, which may rise to typically double the specified output voltage if the output load falls to less than 5%.

### Capacitive loading and start up

Typical start up times for this series, with a typical input voltage rise time of 2.2µs and output capacitance of 10µF, are shown in the table below. The product series will start into a capacitance of 47µF with an increased start time, however, the maximum recommended output capacitance is 10µF.

|              | Start-up time<br>µs |
|--------------|---------------------|
| CRE1S0505DC  | 190                 |
| CRE1S0505SC  | 190                 |
| CRE1S0515SC  | 1790                |
| CRE1S1205SC  | 125                 |
| CRE1S1212SC  | 500                 |
| CRE1S2405SC  | 135                 |
| CRE1S2412SC  | 430                 |
| CRE1S0305S3C | 295                 |
| CRE1S0505S3C | 165                 |
| CRE1S0505MC  | 1368                |
| CRE1S0505MEC | 170                 |

Typical Start-Up Wave Form

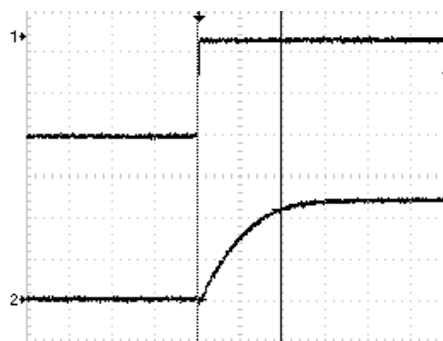

**APPLICATION NOTES (continued)**

**Ripple & Noise Characterisation Method**

Ripple and noise measurements are performed with the following test configuration.

|       |  |
|-------|--|
| C1    | 1µF X7R multilayer ceramic capacitor, voltage rating to be a minimum of 3 times the output voltage of the DC/DC converter                                |
| C2    | 10µF tantalum capacitor, voltage rating to be a minimum of 1.5 times the output voltage of the DC/DC converter with an ESR of less than 100mΩ at 100 kHz |
| C3    | 100nF multilayer ceramic capacitor, general purpose  |
| R1    | 450Ω resistor, carbon film, ±1% tolerance  |
| R2    | 50Ω BNC termination  |
| T1    | 3T of the coax cable through a ferrite toroid  |
| RLOAD | Resistive load to the maximum power rating of the DC/DC converter. Connections should be made via twisted wires  |

Measured values are multiplied by 10 to obtain the specified values.

**Differential Mode Noise Test Schematic**

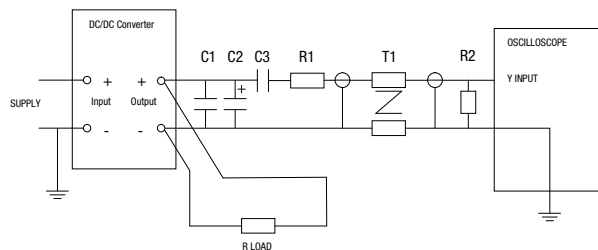

**Output Ripple Reduction**

By using the values of inductance and capacitance stated, the output ripple at the rated load is lowered to 5mV p-p max.

**Component selection**

**Capacitor:** It is required that the ESR (Equivalent Series Resistance) should be as low as possible, ceramic types are recommended. The voltage rating should be at least twice (except for 15V output), the rated output voltage of the DC/DC converter.

**Inductor:** The rated current of the inductor should not be less than that of the output of the DC/DC converter. At the rated current, the DC resistance of the inductor should be such that the voltage drop across the inductor is <2% of the rated voltage of the DC/DC converter. The SRF (Self Resonant Frequency) should be >20MHz.

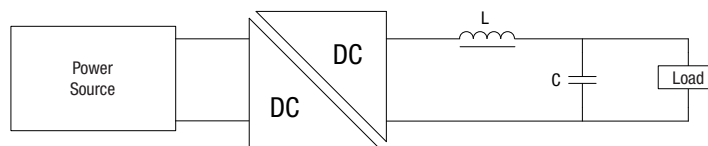

|              | Inductor |        | Capacitor    |
|--------------|----------|--------|--------------|
|              | L, µH    | SMD    | Through Hole |
| CRE1S0505DC  |          |        |              |
| CRE1S0505SC  |          |        |              |
| CRE1S0515SC  |          |        |              |
| CRE1S1205SC  |          |        |              |
| CRE1S1212SC  |          |        |              |
| CRE1S2405SC  |          |        |              |
| CRE1S2412SC  |          |        |              |
| CRE1S0305S3C |          |        |              |
| CRE1S0505S3C |          |        |              |
| CRE1S0505MC  | 47       | 82473C | 11R473C      |
| CRE1S0505MEC | 10       | 82103C | 11R103C      |

**EMC FILTERING AND SPECTRA**

**FILTERING**

The following table shows the additional input capacitor and input inductor typically required to meet EN 55022 Curve B Quasi-Peak EMC limit, as shown in the following plots. The following plots show positive and negative quasi peak and CISPR22 Average Limit B (pink line) and Quasi Peak Limit B (green line) adherence limits. The recommended input capacitor to use for this circuit is 50V 16V X7R ceramic capacitor. For the CRE1S0505MEC an input inductor is not required.

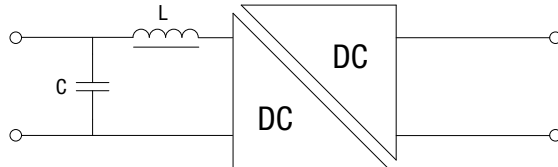

| Part Number  | Inductor   |        |              | Capacitor  |
|--------------|------------|--------|--------------|------------|
|              | L, $\mu$ H | SMD    | Through Hole | C, $\mu$ F |
| CRE1S0505DC  | 4.7        | 82472C | 13R472C      | 4.7        |
| CRE1S0505SC  | 4.7        | 82472C | 13R472C      | 4.7        |
| CRE1S0515SC  | 4.7        | 82472C | 13R472C      | 4.7        |
| CRE1S1205SC  | 10         | 82103C | 13R103C      | 1          |
| CRE1S1212SC  | 10         | 82103C | 13R103C      | 1          |
| CRE1S2405SC  | 22         | 82223C | 13R223C      | 10         |
| CRE1S2412SC  | 22         | 82223C | 13R223C      | 10         |
| CRE1S0305S3C | 10         | 82103C | 13R103C      | 1          |
| CRE1S0505S3C | 10         | 82103C | 13R103C      | 1          |
| CRE1S0505MC  | 10         | 82103C | 13R103C      | 4.7        |
| CRE1S0505MEC | N/A        | N/A    | N/A          | 22         |

**CRE1S0505XC**

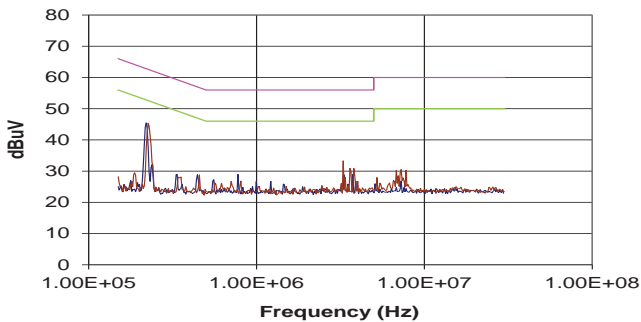

**CRE1S0515SC**

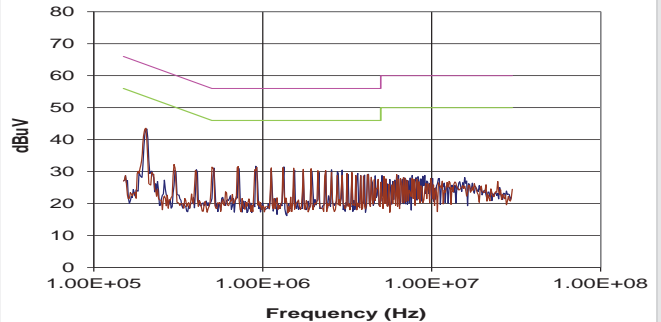

**CRE1S1205SC**

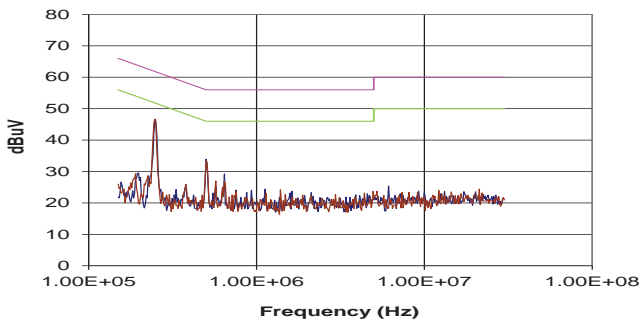

**CRE1S1212SC**

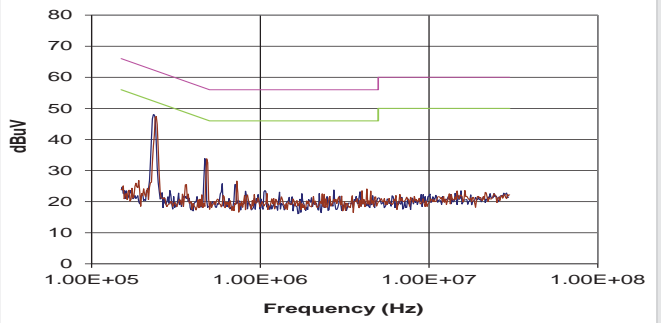



**EMC FILTERING AND SPECTRA**

**CRE1S2405SC**

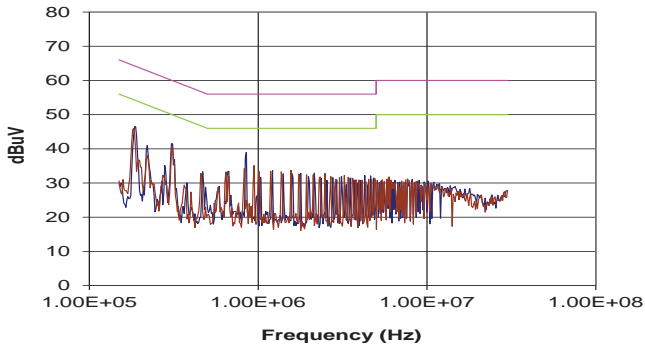

**CRE1S2412SC**

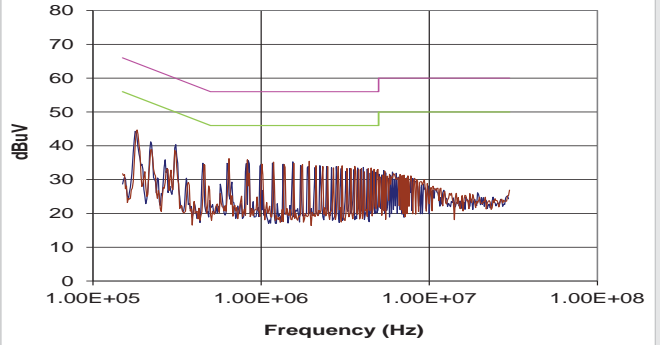

**CRE1S0305S3C**

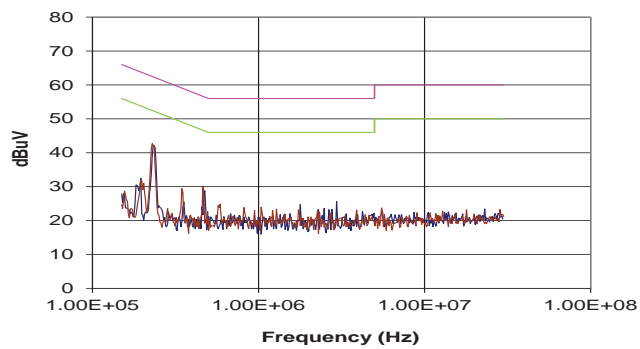

**CRE1S0505S3C**

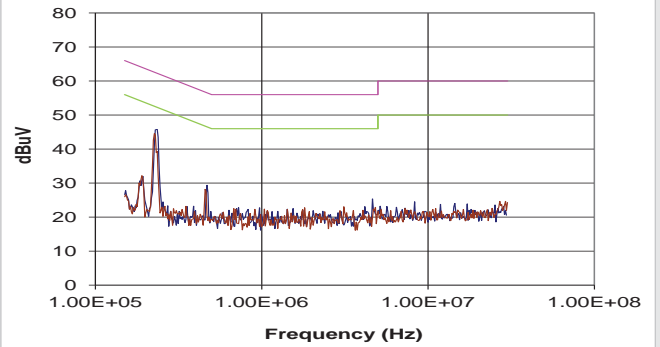

**CRE1S0505MC**

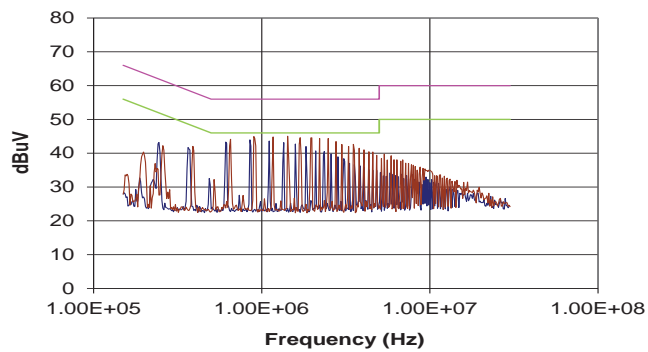

**CRE1S0505MEC**

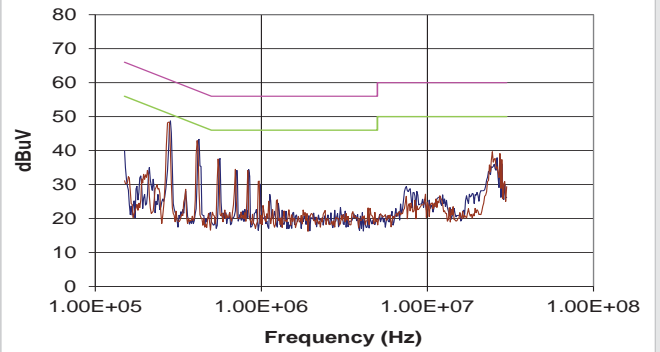

## PACKAGE SPECIFICATIONS

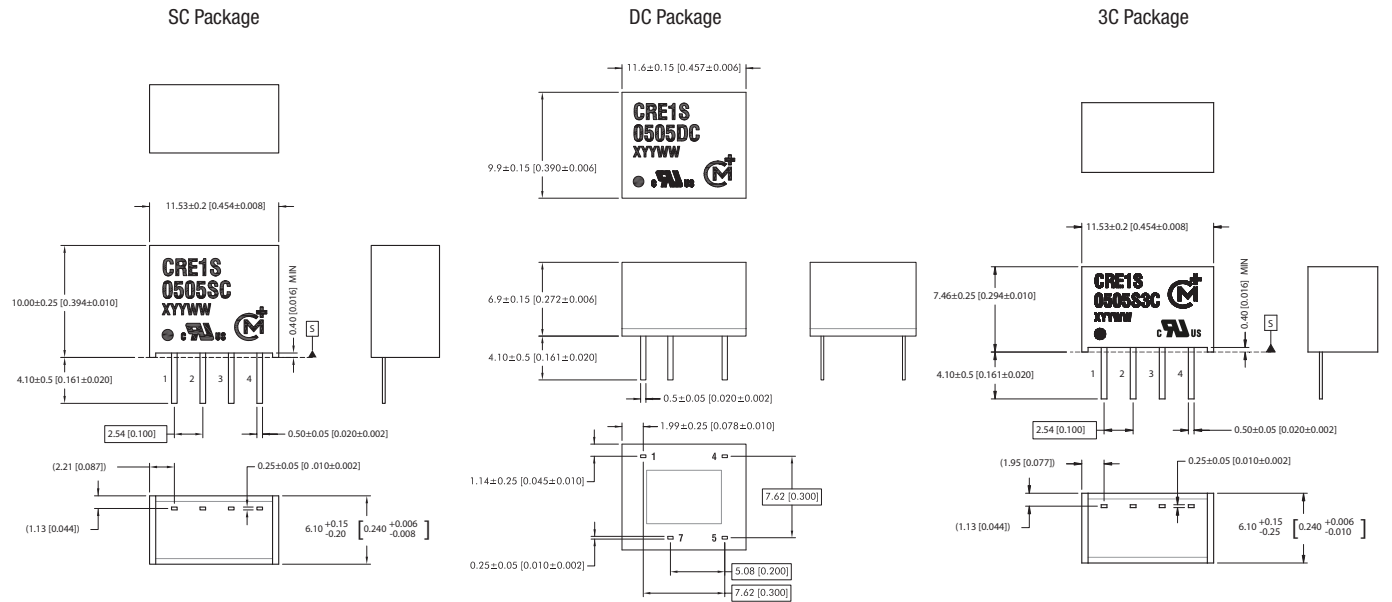

All dimensions in mm (inches) Controlling dimension is mm.

All pins on a 2.54 (0.100) pitch and within ±0.1 (0.004) of true position from pin 1 at seating plane 'S' (SC&3C)

All pins on a 2.54 (0.100) pitch and within ±0.25 (0.010) of true position (DC)

Weight: 1.09g (3C) 1.30g (SC) 1.38g (DC)

### PIN CONNECTIONS SC & 3C - 4 PIN SIP

| Pin | Function |
|-----|----------|
| 1   | -VIN     |
| 2   | +VIN     |
| 3   | -VOUT    |
| 4   | +VOUT    |

### PIN CONNECTIONS DC - 8 PIN DIP

| Pin | Function |
|-----|----------|
| 1   | -VIN     |
| 4   | +VIN     |
| 5   | +VOUT    |
| 7   | -VOUT    |

**PACKAGE SPECIFICATIONS (Continued)**

CRE1S0505MC

CRE1S0505MEC

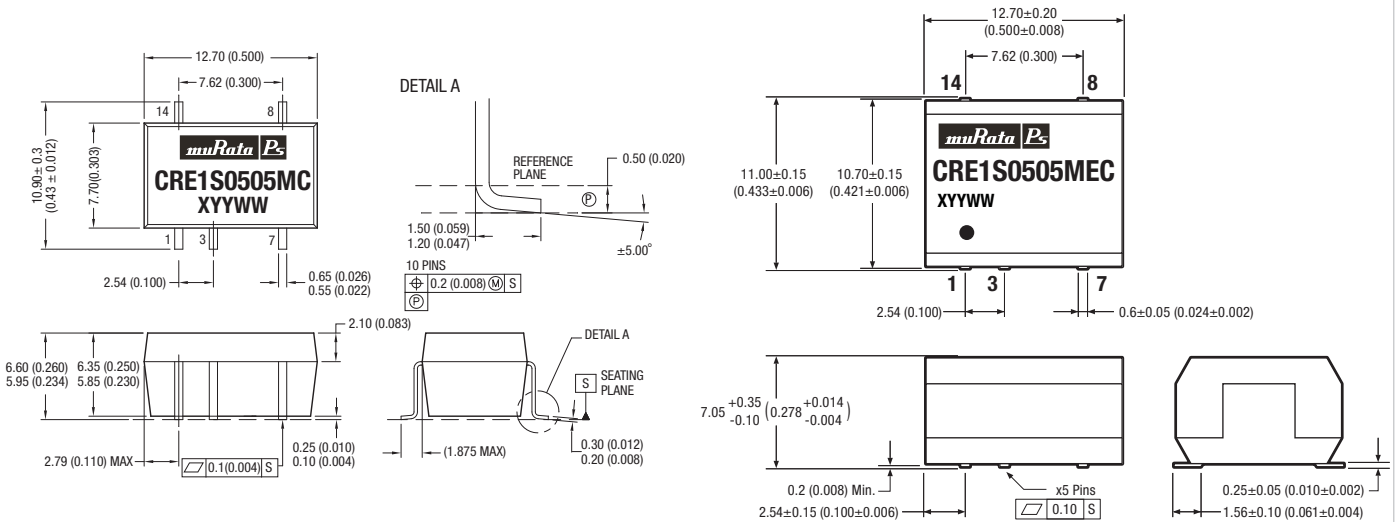

All dimensions in mm (inches) Controlling dimension is mm.  
 All pins on a 2.54 (0.100) pitch and within ±0.25 (0.010) of true position

**PIN CONNECTIONS - CRE1SXXXXMC/MEC**

| Pin | Function |
|-----|----------|
| 1   | -VIN     |
| 3   | +VIN     |
| 7   | -VOUT    |
| 8   | +VOUT    |
| 14  | NA       |

Weight: 1.2g

**PACKAGE SPECIFICATIONS (continued)**

**RECOMMENDED FOOTPRINT DETAILS**

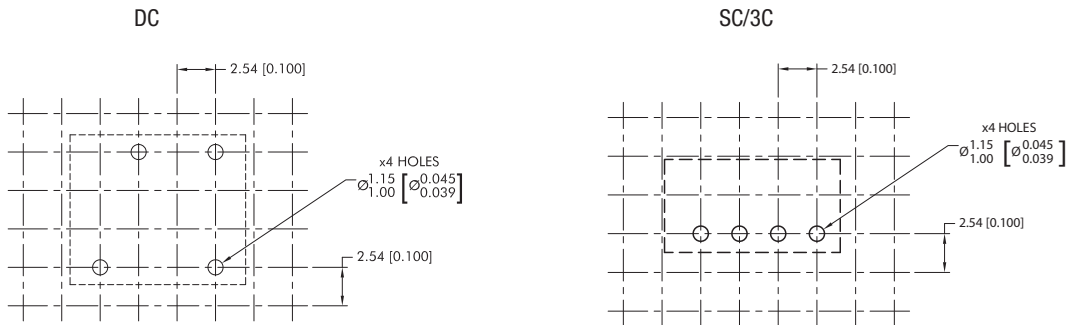

**TUBE OUTLINE DIMENSIONS**

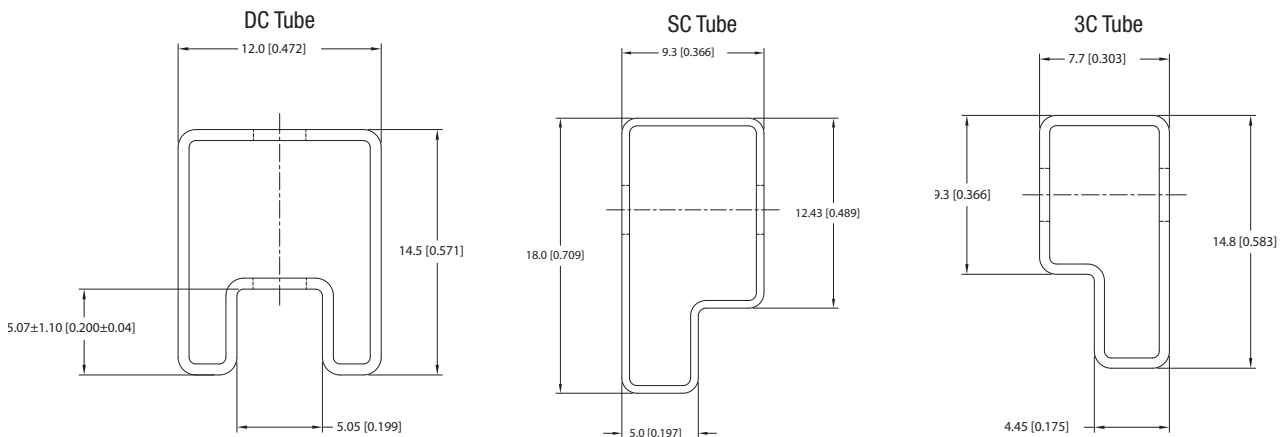

Unless otherwise specified all dimensions in mm [inches]  $\pm 0.55\text{mm}$  [0.022].  
 Tube Length (DC&SC) : 520mm [20.472]  $\pm 2.0$  [0.079]  
 Tube Length (3C) : 525mm [20.669]  $\pm 2.0$  [0.079].

Tube Quantity (DC & SC): 35  
 (3C):40

**PACKAGE SPECIFICATIONS (continued)**

**RECOMMENDED FOOTPRINT DETAILS**

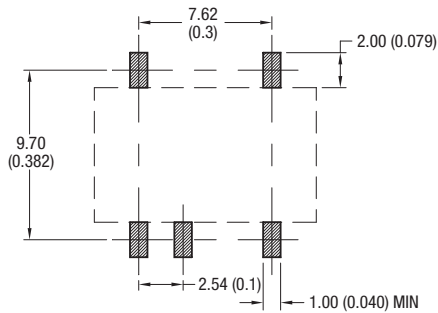

**TUBE OUTLINE DIMENSIONS**

**CRE1S0505MC**

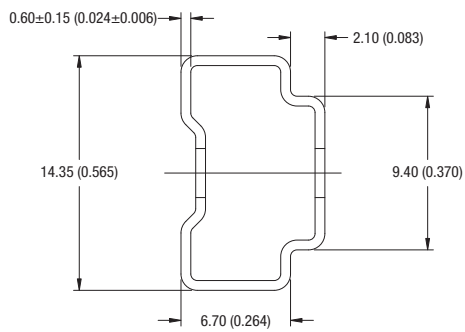

**CRE1S0505MEC**

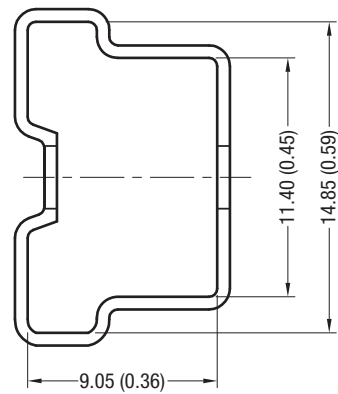

Unless otherwise specified all dimensions in mm [inches] ±0.55mm [0.022].  
 Tube Length (MC&MEC) : 475±2.0 (18.70±0.07).

Tube Quantity (MC): 35  
 (MEC): 30

**TAPE & REEL SPECIFICATIONS**

**REEL OUTLINE DIMENSIONS**

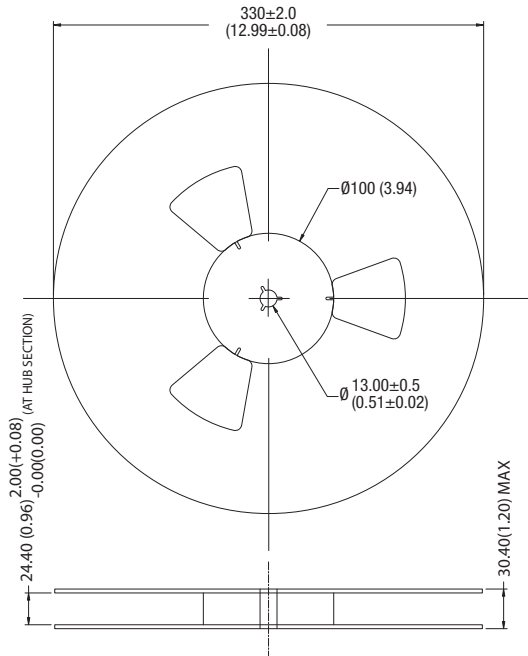

**TAPE OUTLINE DIMENSIONS**

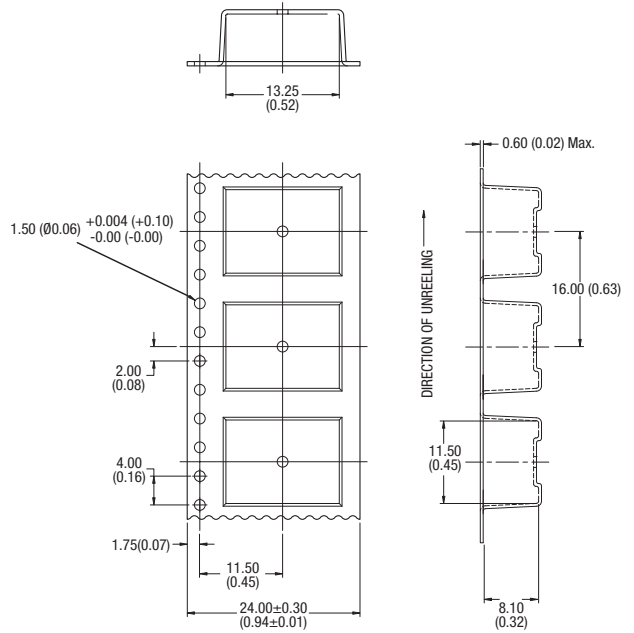

**REEL PACKAGING DETAILS**

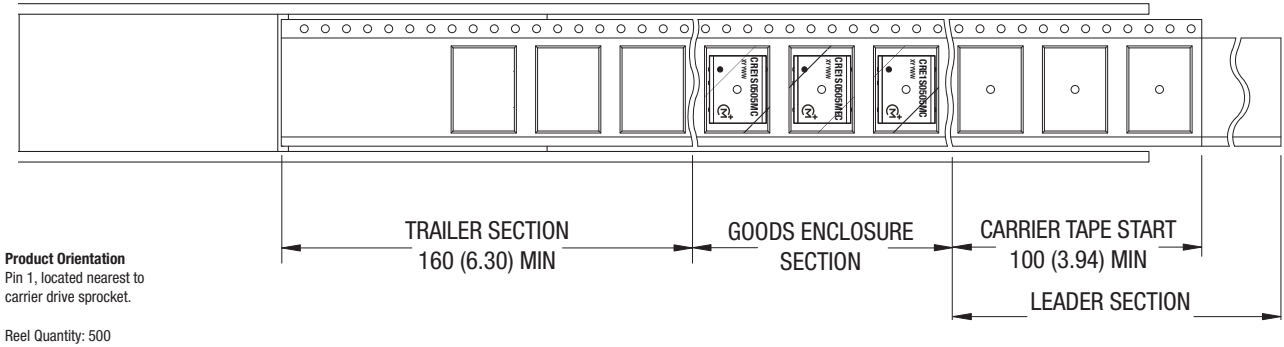

Murata Power Solutions, Inc.  
 11 Cabot Boulevard, Mansfield, MA 02048-1151 U.S.A.  
 ISO 9001 and 14001 REGISTERED



This product is subject to the following **operating requirements** and the **Life and Safety Critical Application Sales Policy**:  
 Refer to: <http://www.murata-ps.com/requirements/>

Murata Power Solutions, Inc. makes no representation that the use of its products in the circuits described herein, or the use of other technical information contained herein, will not infringe upon existing or future patent rights. The descriptions contained herein do not imply the granting of licenses to make, use, or sell equipment constructed in accordance therewith. Specifications are subject to change without notice. © 2017 Murata Power Solutions, Inc.