

FEATURES

- Patent protected
- No opto feedback
- Optimised bipolar output voltages for IGBT/ SiC & MOSFET gate drives
- Configurable dual outputs for all gate drive applications:
+15V/-5V, +15V/-10V & +20V/-5V outputs
- Reinforced insulation to UL60950 recognised
- ANSI/AAMI ES60601-1 recognition pending
- Characterised dv/dt immunity 80kV/μs at 1.6kV
- Characterised partial discharge performance
- 5.7kVDC isolation test voltage 'Hi Pot Test'
- Ultra low coupling capacitance 15pF
- DC link voltage 3kVDC
- 5V, 12V & 24V input voltages
- 105°C operating temperature

PRODUCT OVERVIEW

Offering configurable dual output voltages of +15V/-10V, +20V/-5V and +15V/-5V, the MGJ6 series of DC-DC converters is ideal for powering 'high side' and 'low side' gate drive circuits for IGBTs, Silicon Carbide and MOSFETs in bridge circuits.

A choice of asymmetric output voltages allows optimum drive levels for best system efficiency and EMI. The MGJ6 series is characterised for high isolation and dv/dt requirements commonly seen in bridge circuits used in motor drives and inverters. A disable/frequency synchronisation pin simplifies EMC filter design. The MGJ6 protection features include short circuit protection and overload protection.



For full details go to
www.murata-ps.com/rohs



SELECTION GUIDE

Order Code ¹	Input Voltage Range	Typical Application	Output 1			Output 2		
			Rated Output Voltage	Rated Output Current	Output Power	Rated Output Voltage	Rated Output Current	Output Power
			V	mA	W	V	mA	W
MGJ6D051510DC	4.5 - 9	IGBT	+15	240	3.6	-10	240	2.4
MGJ6D121510DC	9 - 18	IGBT	+15	240	3.6	-10	240	2.4
MGJ6D241510DC	18 - 36	IGBT	+15	240	3.6	-10	240	2.4
MGJ6D052005DC	4.5 - 9	SiC	+20	240	4.8	-5	240	1.2
MGJ6D122005DC	9 - 18	SiC	+20	240	4.8	-5	240	1.2
MGJ6D242005DC	18 - 36	SiC	+20	240	4.8	-5	240	1.2
MGJ6D051505DC	4.5 - 9	MOSFET	+15	300	4.5	-5	300	1.5
MGJ6D121505DC	9 - 18	MOSFET	+15	300	4.5	-5	300	1.5
MGJ6D241505DC	18 - 36	MOSFET	+15	300	4.5	-5	300	1.5
MGJ6D051510SC	4.5 - 9	IGBT	+15	240	3.6	-10	240	2.4
MGJ6D121510SC	9 - 18	IGBT	+15	240	3.6	-10	240	2.4
MGJ6D241510SC	18 - 36	IGBT	+15	240	3.6	-10	240	2.4
MGJ6D052005SC	4.5 - 9	SiC	+20	240	4.8	-5	240	1.2
MGJ6D122005SC	9 - 18	SiC	+20	240	4.8	-5	240	1.2
MGJ6D242005SC	18 - 36	SiC	+20	240	4.8	-5	240	1.2
MGJ6D051505SC	4.5 - 9	MOSFET	+15	300	4.5	-5	300	1.5
MGJ6D121505SC	9 - 18	MOSFET	+15	300	4.5	-5	300	1.5
MGJ6D241505SC	18 - 36	MOSFET	+15	300	4.5	-5	300	1.5

1. Components are supplied in tray packaging, please refer to package specification section for more details. All specifications typical at T_a=25°C, nominal input voltage and rated output current unless otherwise specified.

SELECTION GUIDE (Continued)

Order Code ¹	Input Voltage Range	Typical Application See page 3	Output 1				Output 2			
			Load Regulation (Typ)	Load Regulation (Max)	Ripple & Noise (Typ) ²	Ripple & Noise (Max) ²	Load Regulation (Typ)	Load Regulation (Max)	Ripple & Noise (Typ) ²	Ripple & Noise (Max) ²
			%		mVp-p		%		mVp-p	
MGJ6D051510DC	4.5 - 9	IGBT	5	10	150	200	5	10	70	110
MGJ6D121510DC	9 - 18	IGBT	5	10	150	200	5	10	70	110
MGJ6D241510DC	18 - 36	IGBT	5	10	150	200	5	10	70	110
MGJ6D052005DC	4.5 - 9	SiC	5	10	150	200	5	10	70	110
MGJ6D122005DC	9 - 18	SiC	5	10	150	200	5	10	70	110
MGJ6D242005DC	18 - 36	SiC	5	10	150	200	5	10	70	110
MGJ6D051505DC	4.5 - 9	MOSFET	5	10	150	200	5	10	70	110
MGJ6D121505DC	9 - 18	MOSFET	5	10	150	200	5	10	70	110
MGJ6D241505DC	18 - 36	MOSFET	5	10	150	200	5	10	70	110
MGJ6D051510SC	4.5 - 9	IGBT	5	10	150	200	5	10	70	110
MGJ6D121510SC	9 - 18	IGBT	5	10	150	200	5	10	70	110
MGJ6D241510SC	18 - 36	IGBT	5	10	150	200	5	10	70	110
MGJ6D052005SC	4.5 - 9	SiC	5	10	150	200	5	10	70	110
MGJ6D122005SC	9 - 18	SiC	5	10	150	200	5	10	70	110
MGJ6D242005SC	18 - 36	SiC	5	10	150	200	5	10	70	110
MGJ6D051505SC	4.5 - 9	MOSFET	5	10	150	200	5	10	70	110
MGJ6D121505SC	9 - 18	MOSFET	5	10	150	200	5	10	70	110
MGJ6D241505SC	18 - 36	MOSFET	5	10	150	200	5	10	70	110

1. Components are supplied in tray packaging, please refer to package specification section for more details.
 2. See ripple & noise test method.

SELECTION GUIDE (Continued)

Order Code ¹	Nominal Input Voltage	Input Current at Rated Load	Efficiency (Min)	Efficiency (Typ)	Isolation Capacitance	MTTF ²	
						MIL-217	Telecordia
						kHrs	
V	mA	%	pF				
MGJ6D051510DC	5	1500	77.5	80	15	627	12,576
MGJ6D121510DC	12	620	77.5	80	15	789	19,546
MGJ6D241510DC	24	300	80	82	15	784	19,570
MGJ6D052005DC	5	1500	77.5	80	15	627	12,576
MGJ6D122005DC	12	620	77.5	80	15	789	19,546
MGJ6D242005DC	24	300	80	82	15	784	19,570
MGJ6D051505DC	5	1500	77.5	80	15	627	12,576
MGJ6D121505DC	12	620	77.5	80	15	789	19,546
MGJ6D241505DC	24	300	80	82	15	784	19,570
MGJ6D051510SC	5	1500	74	77.5	15	492	13,469
MGJ6D121510SC	12	620	78	80.5	15	789	19,546
MGJ6D241510SC	24	300	80	82	15	784	19,570
MGJ6D052005SC	5	1500	74	77.5	15	492	13,469
MGJ6D122005SC	12	620	78	80.5	15	789	19,546
MGJ6D242005SC	24	300	80	82	15	784	19,570
MGJ6D051505SC	5	1500	74	77.5	15	492	13,469
MGJ6D121505SC	12	620	78	80.5	15	789	19,546
MGJ6D241505SC	24	300	80	82	15	784	19,570

1. Components are supplied in tray packaging, please refer to package specification section for more details.

2. Calculated using MIL-HDBK-217 FN2 and Telcordia SR-332 calculation model with nominal input voltage at full load.

INPUT CHARACTERISTICS					
Parameter	Conditions	Min.	Typ.	Max.	Units
Voltage range	5V input types	4.5	5	9	V
	12V input types	9	12	18	
	24V input types	18	24	36	
Under voltage lock out	Turn on threshold MGJ6D05		4.1		V
	Turn off threshold MGJ6D05		3.0		
	Turn on threshold MGJ6D12		8.1		
	Turn off threshold MGJ6D12		7.5		
	Turn on threshold MGJ6D24		16.7		
	Turn off threshold MGJ6D24		16.3		
Input ripple current	5V input types		40		mA p-p
	12V input types		40		
	24V input types		24		

OUTPUT CHARACTERISTICS					
Parameter	Conditions	Min.	Typ.	Max.	Units
Minimum load	Below 10% load, 5V and 15V outputs are clamped to 6V and 17V respectively	10			%
Voltage set point accuracy	Output 1		±3		%
	Output 2		±5		%
Line regulation	Low line to high line			2	%
Total Regulation				15	%
Transient response	Peak deviation (50-100% & 100-50% load swing)				%V _{out}
	Settling time				ms

GENERAL CHARACTERISTICS					
Parameter	Conditions	Min.	Typ.	Max.	Units
Switching frequency			100		kHz

ISOLATION CHARACTERISTICS					
Parameter	Conditions	Min.	Typ.	Max.	Units
Isolation test voltage	Production tested for 1 second	5700			VDC
	Qualification tested for 1 minute	5700			
Resistance	Viso = 1kVDC	100			GΩ
Continuous barrier withstand voltage	Non-safety barrier application			3000	VDC

ABSOLUTE MAXIMUM RATINGS	
Short-circuit protection	Continuous
Lead temperature 1.0mm from case for 10 seconds (to JEDEC JESD22-B106 ISS C)	260°C
Input voltage, MGJ6 5V input types	12V
Input voltage, MGJ6 12V input types	20V
Input voltage, MGJ6 24V input types	40V

TEMPERATURE CHARACTERISTICS					
Parameter	Conditions	Min.	Typ.	Max.	Units
Operation	See derating graphs	-40		105	°C
Storage		-50		125	
Product temperature rise above ambient	100% Load, Nom V _{IN} , Still Air		30		

RoHS COMPLIANCE, MSL AND PSL INFORMATION



This series is compatible with RoHS soldering systems with a peak wave solder temperature of 260°C for 10 seconds. The pin termination finish on this product series is Tin with Nickel Preplate. The series is backward compatible with Sn/Pb soldering systems.

APPLICATION NOTES

Start-up times

Typical start up times for this series, with no additional output capacitance are:

Output capacitance must not exceed:

Part No.	Start-up times
	ms
MGJ6D051510DC	15
MGJ6D121510DC	15
MGJ6D241510DC	15
MGJ6D052005DC	15
MGJ6D122005DC	15
MGJ6D242005DC	15
MGJ6D051505DC	15
MGJ6D121505DC	15
MGJ6D241505DC	15
MGJ6D051510SC	15
MGJ6D121510SC	15
MGJ6D241510SC	15
MGJ6D052005SC	15
MGJ6D122005SC	15
MGJ6D242005SC	15
MGJ6D051505SC	15
MGJ6D121505SC	15
MGJ6D241505SC	15

Output Voltage	Maximum output capacitance
V	µF
-5	470
-10	220
15	220
20	150

Disable/Frequency synchronisation

Please refer to application notes for further information.

		Min	Typ	Max	Units
Disable/Synch ¹	Pull Down Current		0.5		mA
	Input High	2		5	V
	Input Low	0		0.8	V
Synchronisation	Frequency Range	90	100	110	kHz
	Duty Cycle	25		75	%

The Disable/Synchronization pin has three modes:

1. When a dc logic low voltage is applied to this pin the MGJ6 is disabled and enters a low quiescent current sleep mode.
2. When this pin is left floating or a dc logic high (CMOS/TTL compatible) voltage is applied the MGJ6 is enabled and operates at the programmed frequency of 100kHz.
3. When a square wave of between 90kHz and 110kHz is applied to this pin, the switcher operates at the same frequency as the square wave. The falling edge of the square wave corresponds to the start of the switching cycle. If the signal is slower than 25Hz, it will be interpreted as enabling and disabling the part. If the MGJ6 is disabled, it must be disabled for 7 clock cycles before being re-enabled.

APPLICATION NOTES(Continued)

Output configurations for power switches

Terminal	Pin (SIP)	Pin (DIP)	IGBT	SIC	MOSFET
15V Output	3	5	+15V 0.24A	+20V 0.24A	+15V 0.3A
15V Return 5VA Output	6	4	0V	No connection	0V
5VA Return 5VB Output	5	3	No connection	0V	-5V 0.3A
5VB Return	4	2	-10V 0.24A	-5V 0.24A	No connection

APPLICATION NOTES (Continued)

Schematic for driving IGBT, SiC & MOSFET (SIP)

MGJ DC-DC CONNECTIONS FOR DRIVING IGBT DEVICES

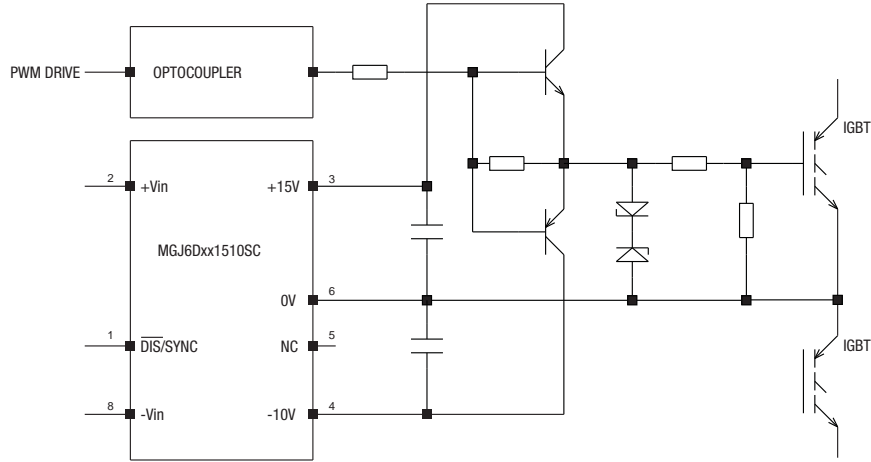

MGJ DC-DC CONNECTIONS FOR DRIVING SiC DEVICES

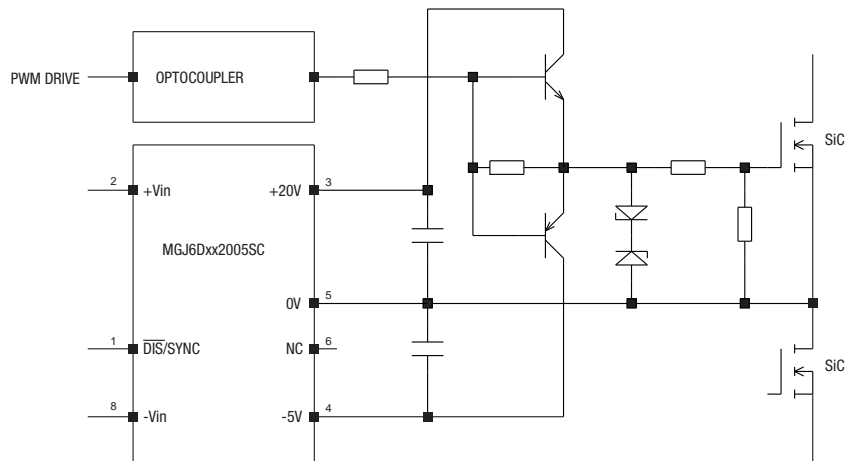

MGJ DC-DC CONNECTIONS FOR DRIVING MOSFET DEVICES

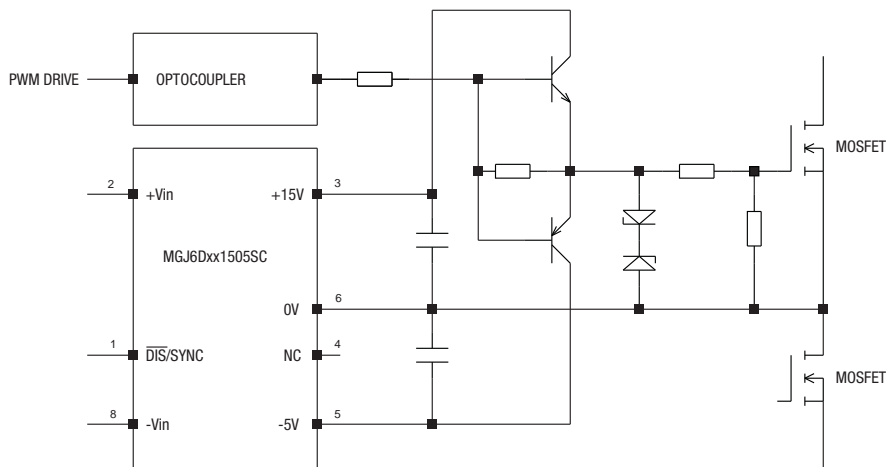

APPLICATION NOTES (Continued)

Schematic for driving IGBT, SiC & MOSFET (DIP)

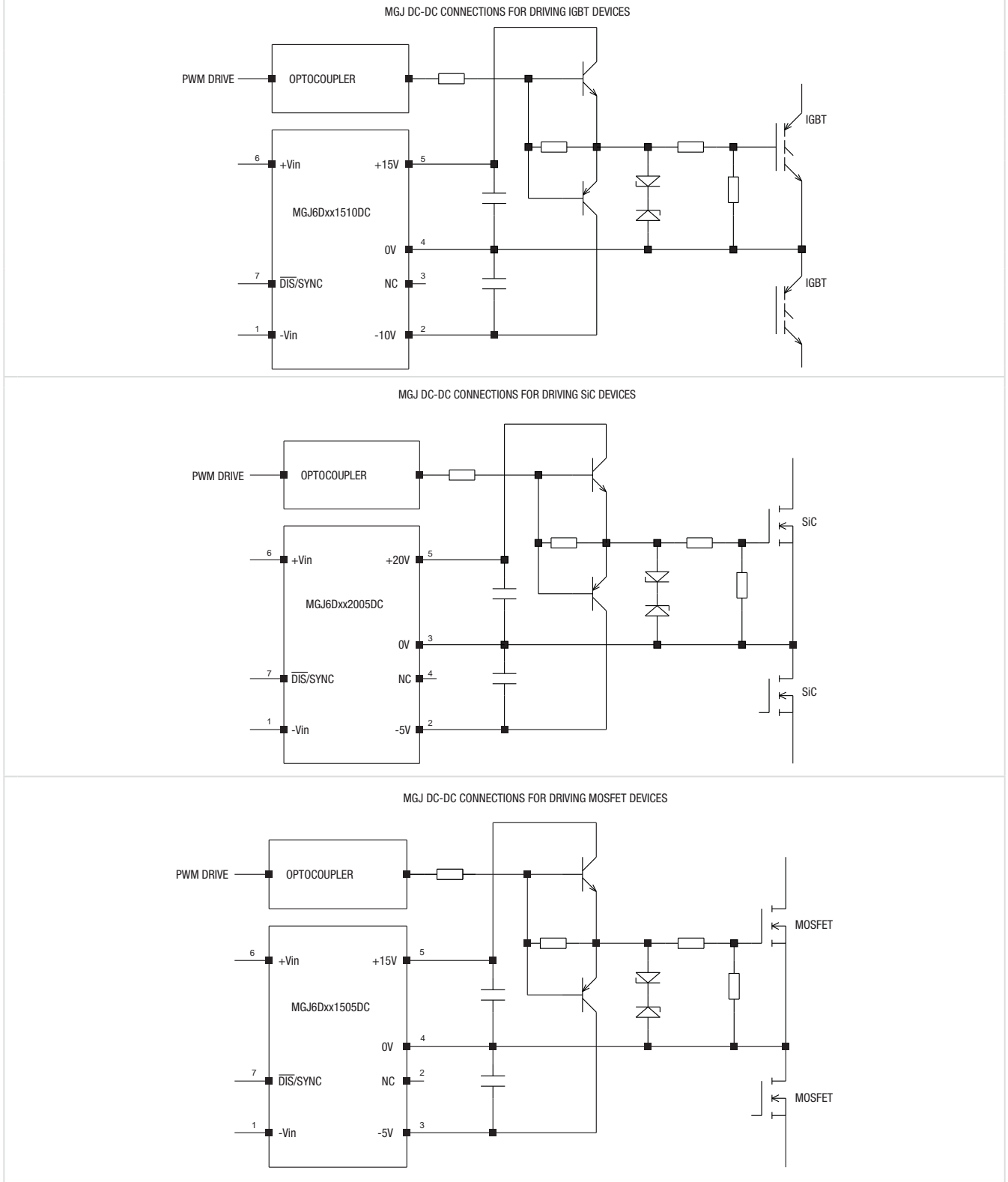

TECHNICAL NOTES

ISOLATION VOLTAGE

'Hi Pot Test', 'Flash Tested', 'Withstand Voltage', 'Proof Voltage', 'Dielectric Withstand Voltage' & 'Isolation Test Voltage' are all terms that relate to the same thing, a test voltage, applied for a specified time, across a component designed to provide electrical isolation, to verify the integrity of that isolation.

Murata Power Solutions MGJ6 series of DC/DC converters are all 100% production tested at 5.7kVDC for 1 second and have been qualification tested at 5.7kVDC for 1 minute.

A question commonly asked is, "What is the continuous voltage that can be applied across the part in normal operation?"

When the insulation in the MGJ6 series is not used as a safety barrier, i.e. provides functional isolation only, continuous or switched voltages across the barrier up to 3kV are sustainable. Long term reliability testing at these voltages continues. Peak Inception voltages measured were in excess of 3.5kV when testing for partial discharge in accordance with IEC 60270. Please contact Murata for further information.

The MGJ6 series has been recognised by Underwriters Laboratory to 250 Vrms Reinforced Insulation, please see safety approval section below.

REPEATED HIGH-VOLTAGE ISOLATION TESTING

It is well known that repeated high-voltage isolation testing of a barrier component can actually degrade isolation capability, to a lesser or greater degree depending on materials, construction and environment. We therefore strongly advise against repeated high voltage isolation testing, but if it is absolutely required, that the voltage be reduced by 20% from specified test voltage.

SAFETY APPROVAL

ANSI/AAMI ES60601-1

The MGJ6 series is pending recognition ANSI/AAMI ES60601-1 and provides 2 MOPP (Means Of Patient Protection) based upon a working voltage of 250 Vrms max., between Primary and Secondary.

UL 60950

The MGJ6 series has been recognised by Underwriters Laboratory (UL) to UL 60950 for reinforced insulation to a working voltage of 250Vrms with a maximum measured product operating temperature of 130°C.

Creepage and clearance 8mm.

FUSING

The MGJ6 Series of converters are not internally fused so to meet the requirements of UL an anti-surge input line fuse should always be used with ratings as defined below.

Input Voltage, 5V 4A

Input Voltage, 12V 2A

Input Voltage, 15V 1A

All fuses should be UL recognized, 125V rated.

CHARACTERISATION TEST METHODS

Ripple & Noise Characterisation Method

Ripple and noise measurements are performed with the following test configuration.

C1	1µF X7R multilayer ceramic capacitor, voltage rating to be a minimum of 3 times the output voltage of the DC/DC converter
C2	10µF tantalum capacitor, voltage rating to be a minimum of 1.5 times the output voltage of the DC/DC converter with an ESR of less than 100mΩ at 100 kHz
C3	100nF multilayer ceramic capacitor, general purpose
R1	450Ω resistor, carbon film, ±1% tolerance
R2	50Ω BNC termination
T1	3T of the coax cable through a ferrite toroid
RLOAD	Resistive load to the maximum power rating of the DC/DC converter. Connections should be made via twisted wires

Measured values are multiplied by 10 to obtain the specified values.

Differential Mode Noise Test Schematic

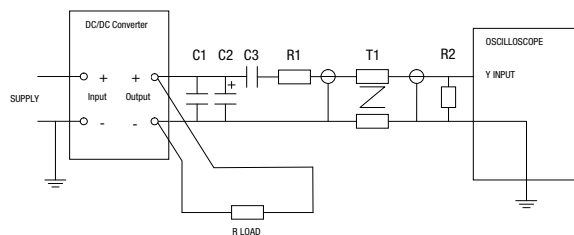

EFFICIENCY VS LOAD

MGJ6D05xxxxDC

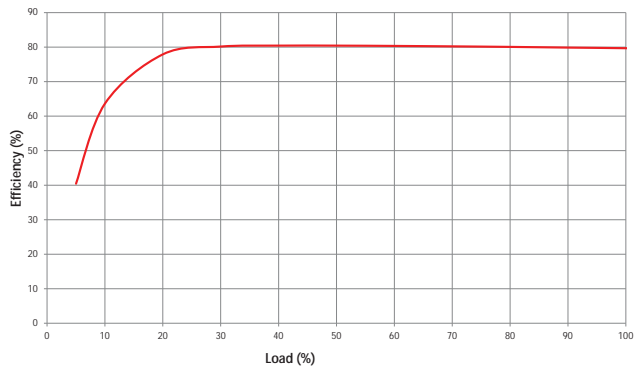

MGJ6D12xxxxDC

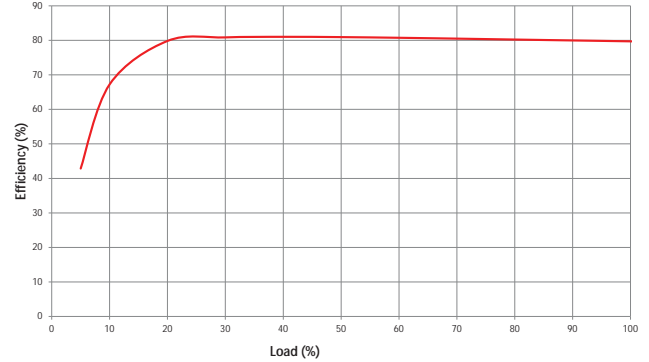

MGJ6D24xxxxDC

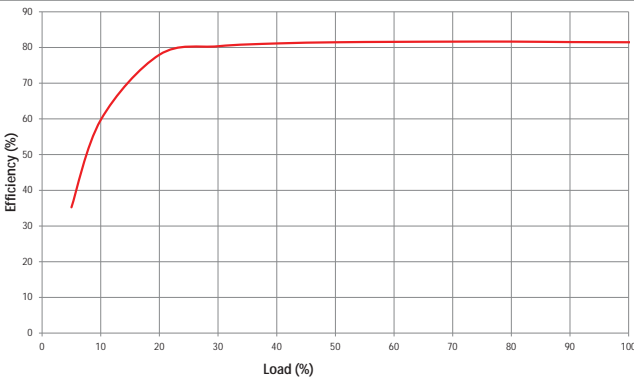

MGJ6D05xxxxSC

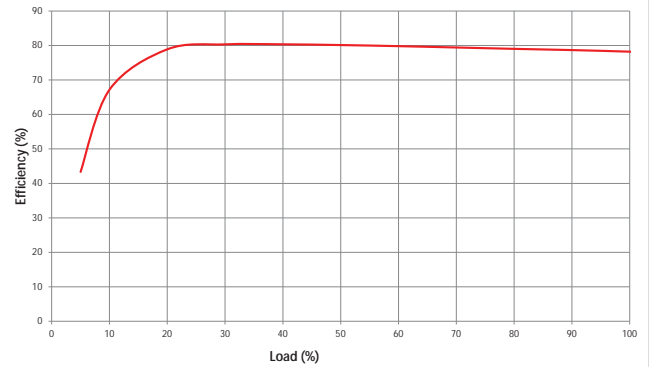

MGJ612xxxxSC

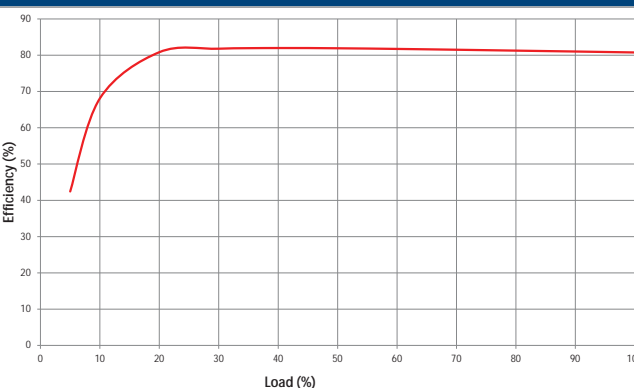

MGJ6D24xxxxSC

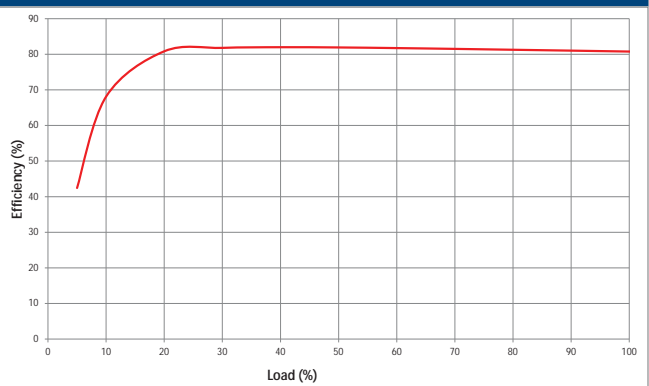

DERATING GRAPHS

Derating curves are based on IPC-9592. With no derating some components may be operating at the manufacturers maximum temperature ratings.

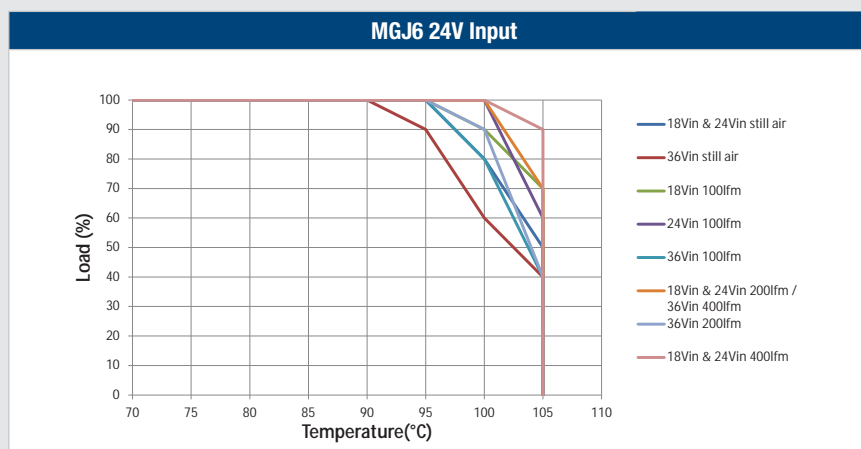
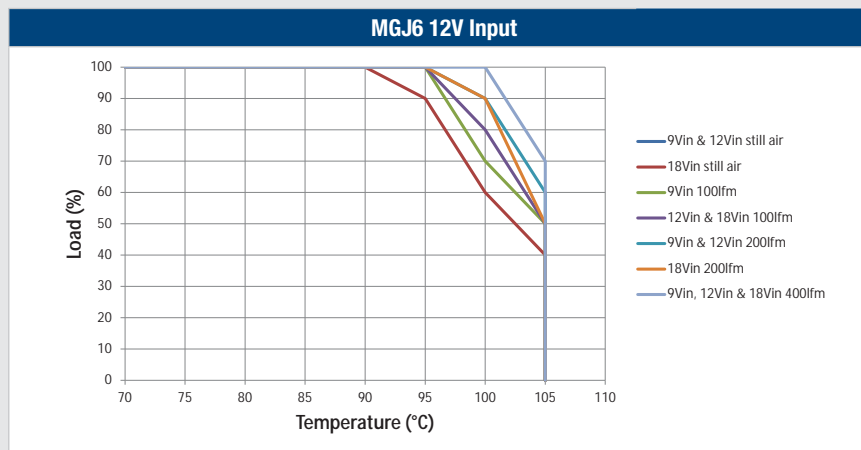
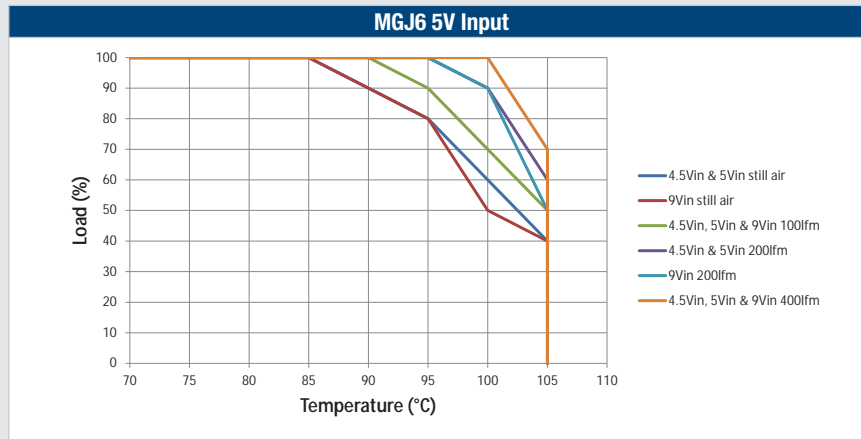

EMC FILTERING AND SPECTRA

FILTERING

The following filter circuit and filter table shows the input filters typically required to meet EN 55022 Curve B, Quasi-Peak EMC limit, as shown in the following plots. The following plots show positive and negative quasi peak and CISPR22 Average Limit B (purple line) and Quasi Peak Limit B (pink line) adherence limits.

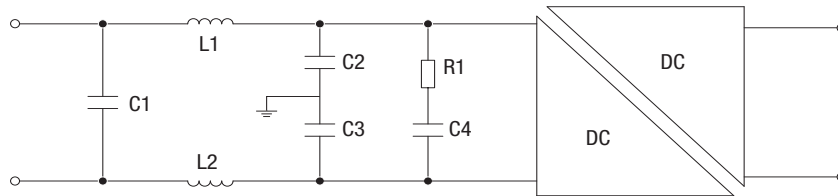

C1, C2 & C3 Polyester or ceramic capacitor

C4 Electrolytic capacitor (note R1 could be omitted if C4 has ESR \geq R1)

TO MEET CURVE B						
Part Number	C1	L1&2	Through Hole	C2&3	R1	C4
MGJ6D05XXXXXC	3.3uF	10uH	47100SC	10nF	500MΩ	470uF
MGJ6D05XXXXXC	3.3uF	10uH	47100SC	10nF	500MΩ	470uF
MGJ6D05XXXXXC	3.3uF	10uH	47100SC	10nF	500MΩ	470uF

MGJ6D05xxxxDC

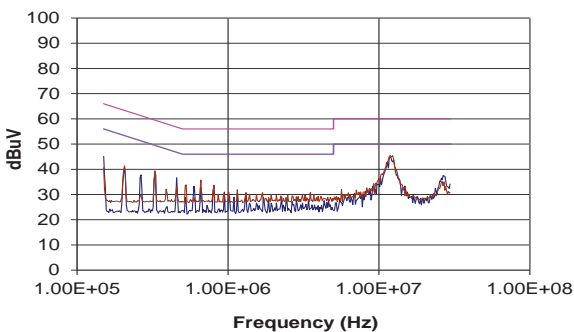

MGJ6D12xxxxDC

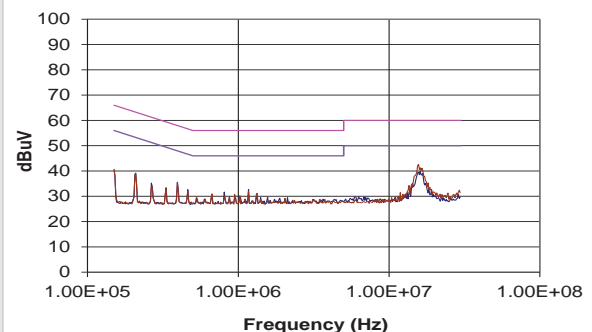

MGJ6D24xxxxDC

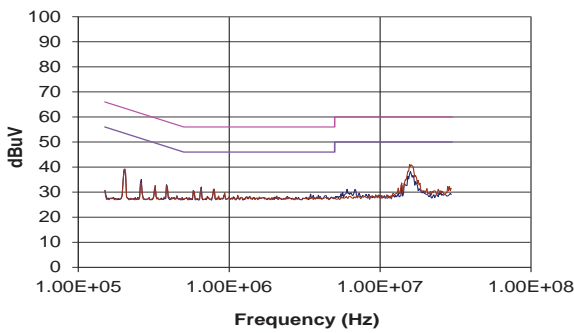

MGJ6D05xxxxSC

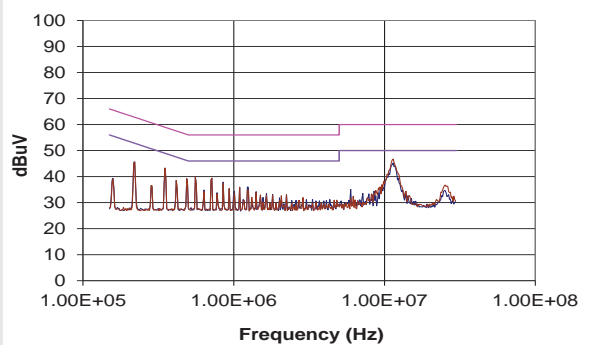

EMC FILTERING AND SPECTRA (Continued)

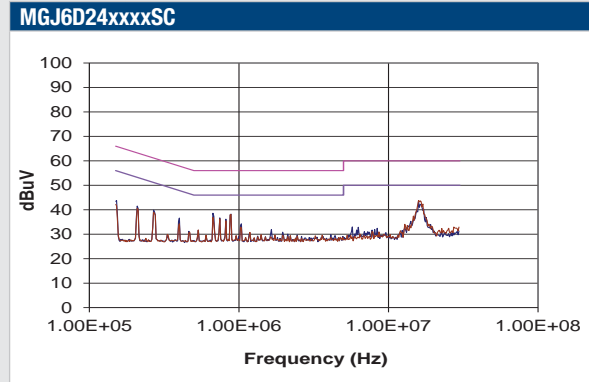
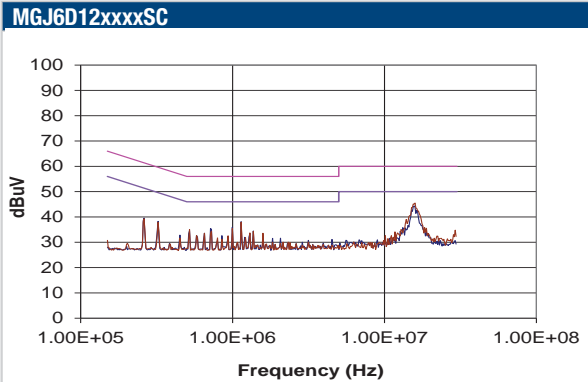

PACKAGE SPECIFICATIONS

MECHANICAL DIMENSIONS (SIP)

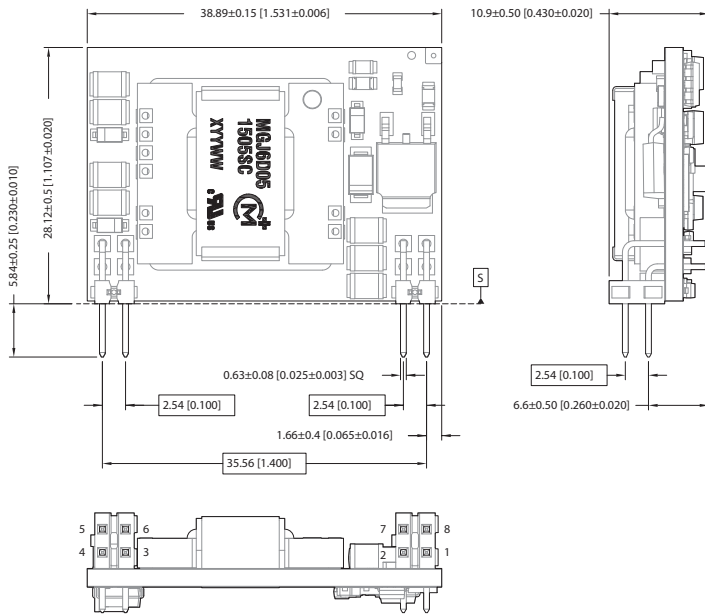

All dimensions in mm (inches), Controlling dimensions is mm.
 All pins on a 2.54 (0.100) pitch and within ±0.1 (0.004) of true position from pin 1 at seating plane 'S'
 Components shown for reference only

Weight: 12g

PIN CONNECTIONS

Pin	Function
1	Dis/Sync
2	+Vin
3	15Vout
4	5VB RTN
5	5VA RTN/5VB
6	15V RTN/5VA
7	-Vin
8	-Vin

RECOMMENDED FOOTPRINT DETAILS

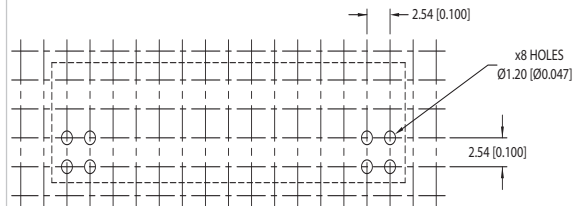

PACKAGE SPECIFICATIONS

MECHANICAL DIMENSIONS (DIP)

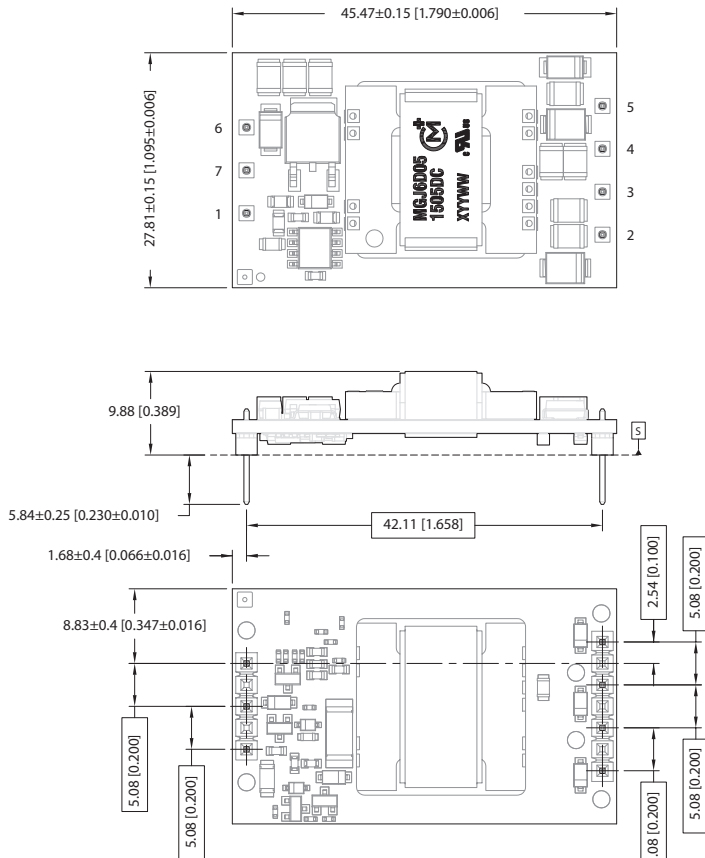

All dimensions in mm (inches). Controlling dimensions is mm.
 All pins on a 2.54 (0.100) pitch and within ±0.1 (0.004) of true position from pin 1 at seating plane 'S'
 Components shown for reference only

Weight: 12g

PIN CONNECTIONS

Pin	Function
1	-Vin
2	5VB RTN
3	5VA RTN/5VB
4	15V RTN/5VA
5	15Vout
6	+Vin
7	Dis/Sync

RECOMMENDED FOOTPRINT DETAILS

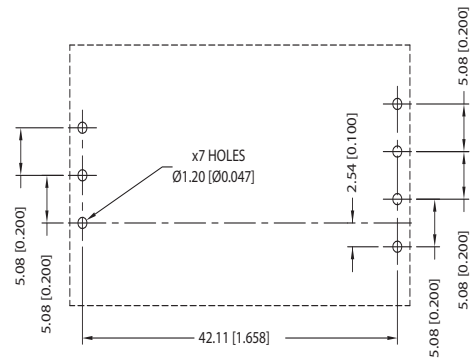

PACKAGING SPECIFICATIONS

TRAY OUTLINE DIMENSIONS

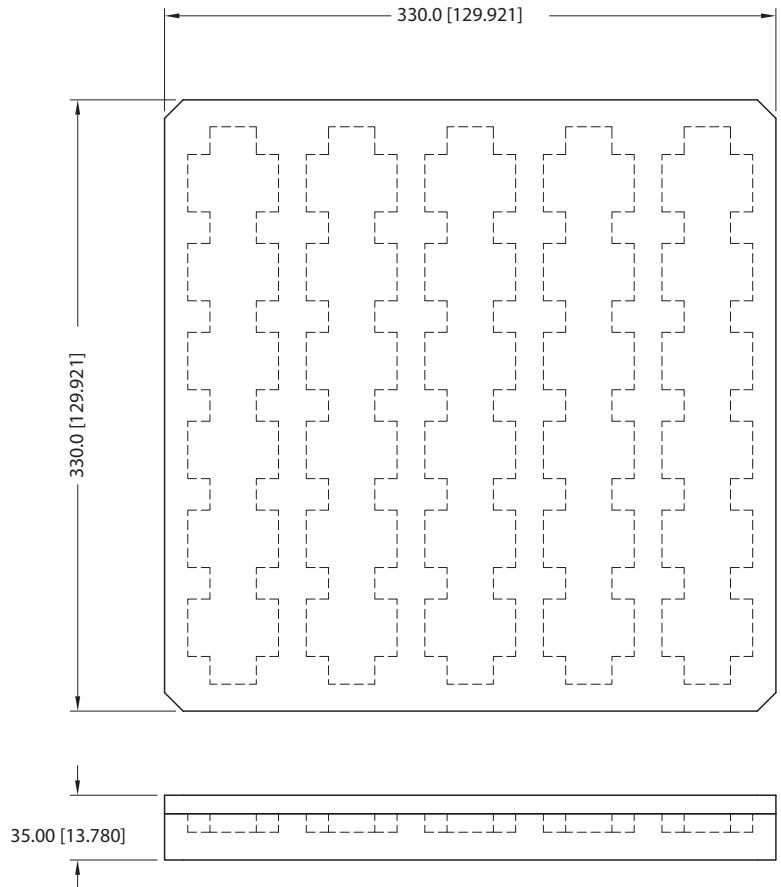

Antistatic Tray
Quantity: 30

Murata Power Solutions, Inc.
11 Cabot Boulevard, Mansfield, MA 02048-1151 U.S.A.
ISO 9001 and 14001 REGISTERED



This product is subject to the following **operating requirements** and the **Life and Safety Critical Application Sales Policy**:
Refer to: <http://www.murata-ps.com/requirements/>

Murata Power Solutions, Inc. makes no representation that the use of its products in the circuits described herein, or the use of other technical information contained herein, will not infringe upon existing or future patent rights. The descriptions contained herein do not imply the granting of licenses to make, use, or sell equipment constructed in accordance therewith. Specifications are subject to change without notice. © 2017 Murata Power Solutions, Inc.