

MICRO-POWER OPERATIONAL AMPLIFIER

■ GENERAL DESCRIPTION

The NJM4250 is extremely versatile programmable monolithic operational amplifiers. A single external master bias current setting resistor programs the input bias current, input offset current, quiescent power consumption, slew rate, input noise, and the gain-bandwidth product. The device is a truly general purpose operational amplifier.

■ PACKAGE OUTLINE

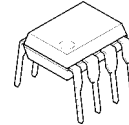

NJM4250D



NJM4250M



NJM4250V

■ FEATURES

- Operating Voltage ($\pm 1V \sim \pm 18V$)
- Low Operating Current (0.1mA max.)
- Programmable monolithic OP-Amp
- Very Low Power Consumption
- Package Outline DIP8, DMP8, SSOP8
- Bipolar Technology

■ PIN CONFIGURATION

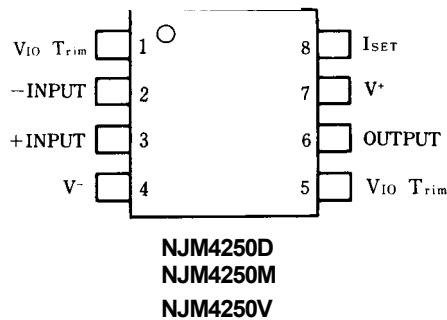

■ EQUIVALENT CIRCUIT

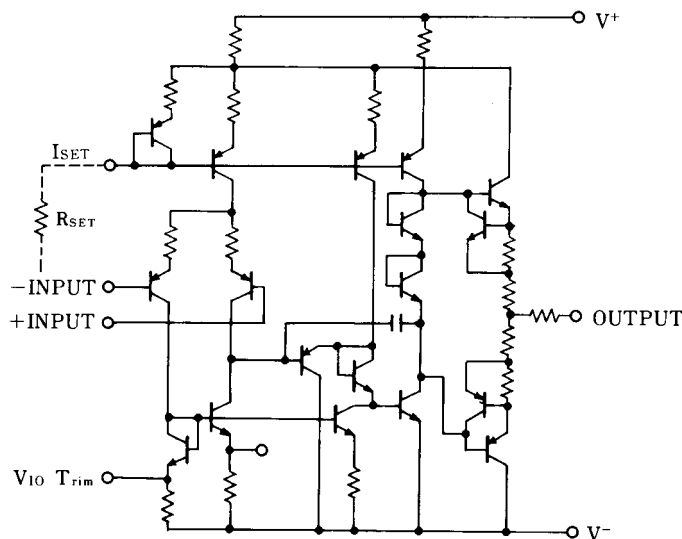

NJM4250

■ ABSOLUTE MAXIMUM RATINGS

(Ta=25°C)

PARAMETER	SYMBOL	RATINGS	UNIT
Supply Voltage	V ⁺ /V ⁻	± 18	V
Differential Input Voltage	V _{ID}	± 30	V
Input Voltage	V _{IC}	± 15 (note)	V
Power Dissipation	P _D	(DIP8) 500 (DMP8) 300 (SSOP8) 250	mW
I _{SET} Current	I _{SET}	150	μA
Operating Temperature Range	T _{opr}	-20~+75	°C
Storage Temperature Range	T _{stg}	-40~+125	°C

(note) For supply voltage less than ±15V, the absolute maximum input voltage is equal to the supply voltage.

■ ELECTRICAL CHARACTERISTICS

(Ta=25°C, V⁺/V⁻=±15V)

PARAMETER	SYMBOL	TEST CONDITION	I _{SET} =1μA		I _{SET} =10μA		UNIT
			MIN.	MAX.	MIN.	MAX.	
Input Offset Voltage 1	V _{IO1}	R _S ≤100kΩ	-	5	-	6	mV
Input Offset Voltage 2	V _{IO2}	V ⁺ /V ⁻ =±1.5V, R _S ≤100kΩ	-	5	-	6	mV
Input Offset Current	I _{IO}		-	6	-	20	nA
Input Bias Current 1	I _{B1}		-	10	-	75	nA
Input Bias Current 2	I _{B2}	V ⁺ /V ⁻ =±1.5V	-	10	-	75	nA
Large Signal Voltage Gain 1	A _{V1}	V _O =± 10V, R _L ≥100kΩ	96	-	-	-	dB
Large Signal Voltage Gain 2	A _{V2}	V _O =± 10V, R _L ≥10kΩ	-	-	96	-	dB
Operating Current 1	I _{CC1}		-	11	-	100	μA
Operating Current 2	I _{CC2}	V ⁺ /V ⁻ =±1.5V	-	8	-	90	μA
Input Common Mode Voltage Range 1	V _{ICM1}		± 13.5	-	± 13.5	-	V
Input Common Mode Voltage Range 2	V _{ICM2}	V ⁺ /V ⁻ =±1.5V	± 0.6	-	± 0.6	-	V
Maximum Output Voltage Swing 1	V _{OM1}	R _L ≥100kΩ	± 12	-	-	-	V
Maximum Output Voltage Swing 2	V _{OM2}	V ⁺ /V ⁻ =±1.5V, R _L ≥100kΩ	± 0.6	-	-	-	V
Maximum Output Voltage Swing 3	V _{OM3}	R _L ≥10kΩ	-	-	± 12	-	V
Maximum Output Voltage Swing 4	V _{OM4}	V ⁺ /V ⁻ =±1.5V, R _L ≥10kΩ	-	-	± 0.6	-	V
Common Mode Rejection Ratio	CMR	R _S ≤10kΩ	70	-	70	-	dB
Supply Voltage Rejection Ratio	SVR	R _S ≤10kΩ	74	-	74	-	dB

■ TYPICAL APPLICATION (I_{SET}, V_{IO} Adjustment)

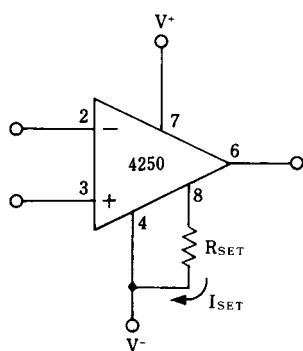

$$I_{SET} = \frac{V^+ + |V^-| - 0.5}{R_{SET}}$$

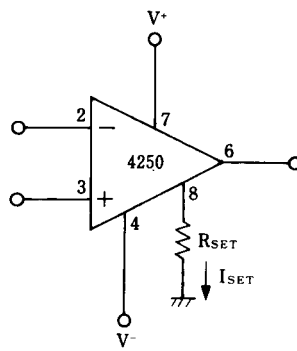

$$I_{SET} = \frac{V^+ - 0.5}{R_{SET}}$$

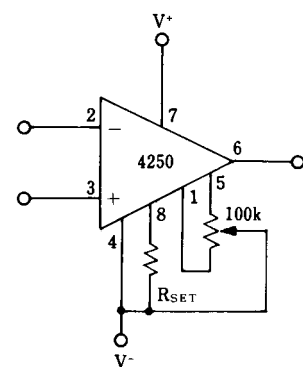

Offset Adjustment

■ TYPICAL CHARACTERISTICS

Input Bias Current vs. Set Current
($T_a = 25^\circ\text{C}$)

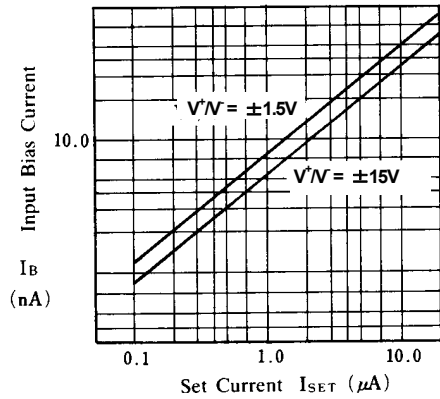

Input Bias Current vs. Temperature

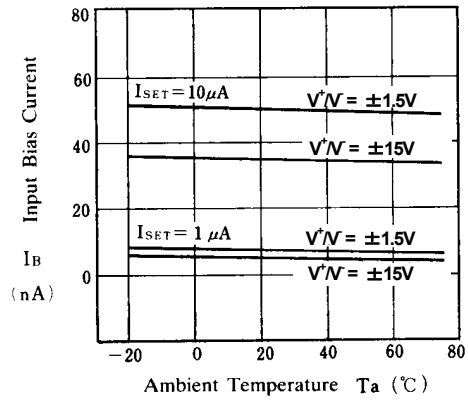

Input Offset Current vs. Ambient Temperature

($I_{SET} = 10\mu\text{A}$, $\pm 1.5\text{V} \leq V^+/V^- \leq \pm 15\text{V}$)

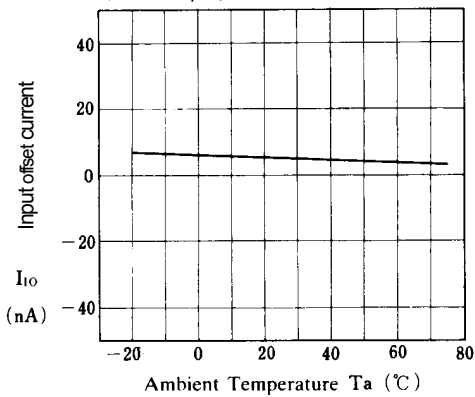

Input Offset Voltage vs. Set Current

($\pm 1.5\text{V} \leq V^+/V^- \leq \pm 15\text{V}$, $T_a = 25^\circ\text{C}$)

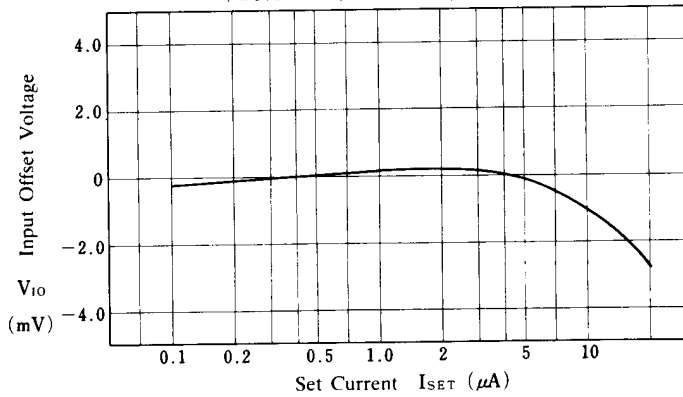

Input Offset Voltage vs. Ambient Temperature

($I_{SET} = 10\mu\text{A}$)

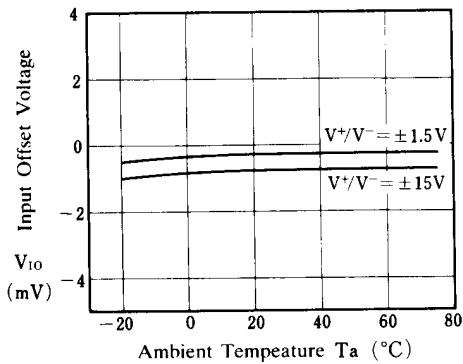

Maximum Output Voltage Swing vs. Output Current

($I_{SET} = 10\mu\text{A}$, $T_a = 25^\circ\text{C}$)

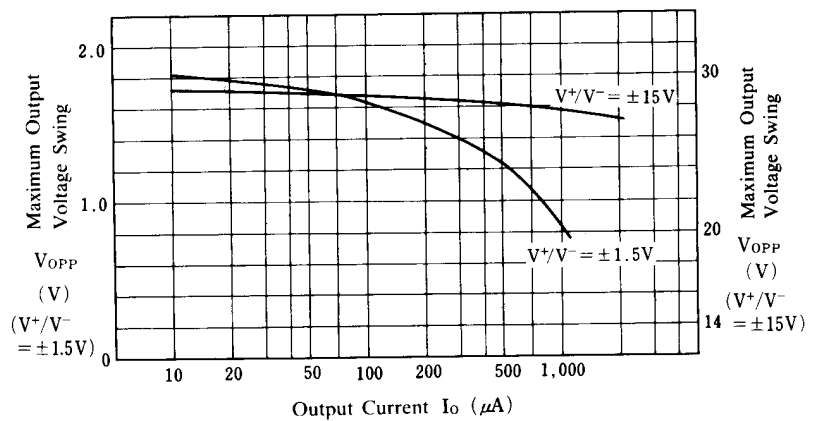

■ TYPICAL CHARACTERISTICS

**Maximum Output Voltage Swing
vs.
Operating Voltage**

($1\mu\text{A} \leq I_{\text{SET}} \leq 10\mu\text{A}$, $R_L = 10\text{k}\Omega$, $T_a = 25^\circ\text{C}$)

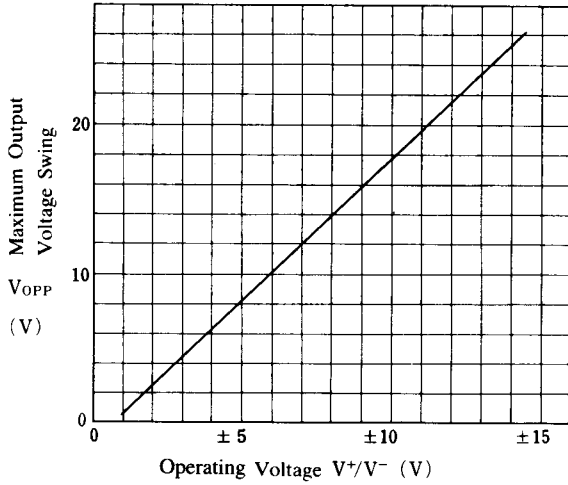

**Operating Current
vs.
Set Current**

($T_a = 25^\circ\text{C}$)

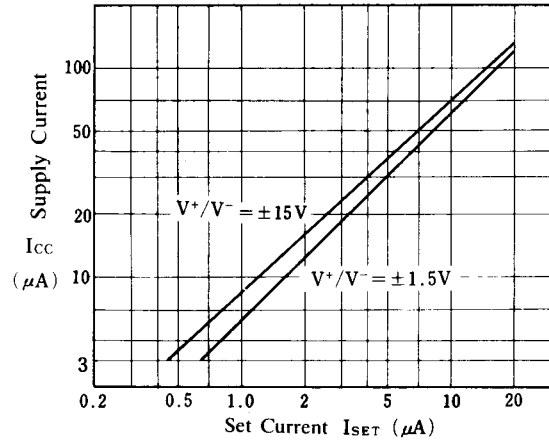

**Operating Current
vs.
Ambient Temperature**

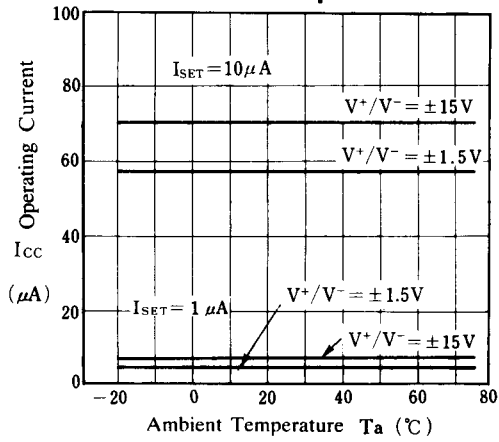

**Open Loop Voltage Gain
vs.
Set Current**

($R_L = 10\text{k}\Omega$, $T_a = 25^\circ\text{C}$)

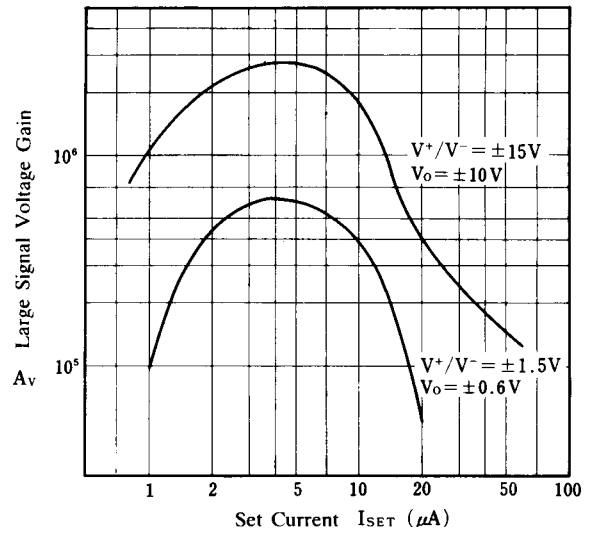

■ TYPICAL CHARACTERISTICS

**Gain Bandwidth Product
Vs.
Set Current**
($T_a = 25^\circ\text{C}$)

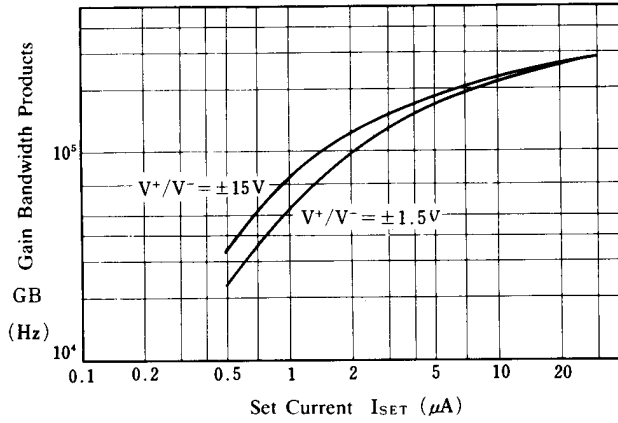

**Slew Rate
vs.
Set Current**
($R_L = 10\text{k}\Omega$, $T_a = 25^\circ\text{C}$)

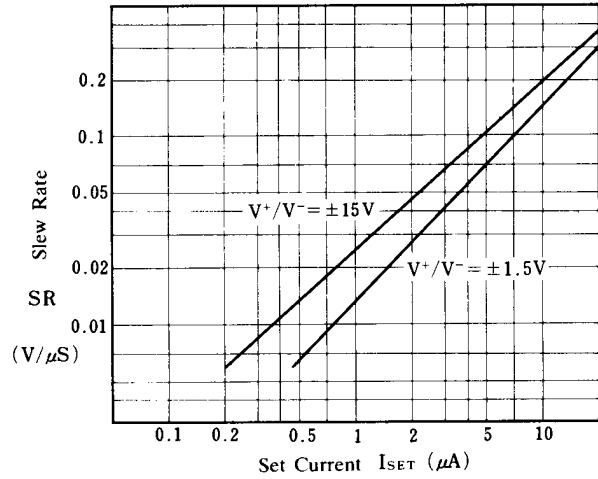

**Phase Margin
vs.
Set Current**

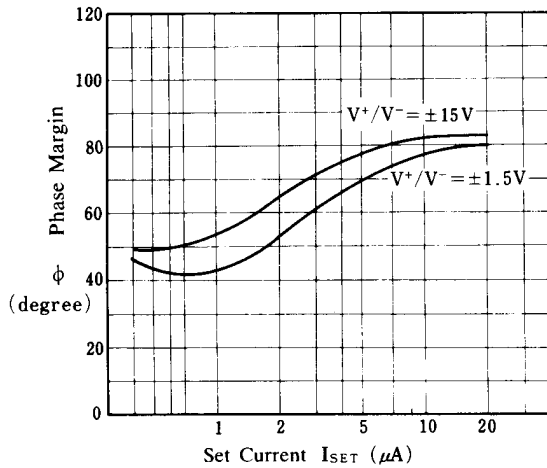

■ TYPICAL APPLICATIONS

Micro-power 10times Inverting Amplifier

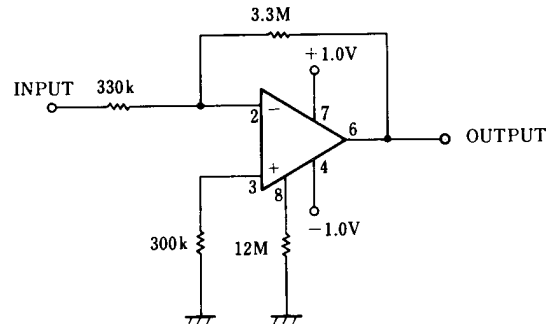

[CAUTION]

The specifications on this databook are only given for information, without any guarantee as regards either mistakes or omissions. The application circuits in this databook are described only to show representative usages of the product and not intended for the guarantee or permission of any right including the industrial rights.