

TWO OUTPUT HIGH VOLTAGE SWITCHING REGULATOR

■ GENERAL DESCRIPTION

New JRC's high voltage switching regulator, NJM2355, is a monolithic high voltage (50V max) operation integrated circuit consisting of two channel PWM controllers.

The NJM2355 contains an internal 5V reference, free running oscillator, low supply voltage detector, two comparators and three error amplifiers. The error amp 2 or amp 3 is for current limiting in channel B output circuit.

The NJM2355 is suited for DC to DC converter application; step up, step down, positive to negative.

■ PACKAGE OUTLINE

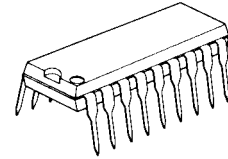

NJM2355D

■ FEATURES

- Operating Voltage (7.5V to 50V)
- Complete PWM Power Control Circuit
- Uncommitted Outputs for 200-mA Sink or Source
- Output control Selects Single-Ended or pull Operation
- Internal Circuitry Prohibits Double Pulse at Either Output
- Variable Dead-Time Provides Control Over Total Range
- Package Outline DIP18
- Bipolar Technology

■ BLOCK DIAGRAM & PIN CONFIGURATION

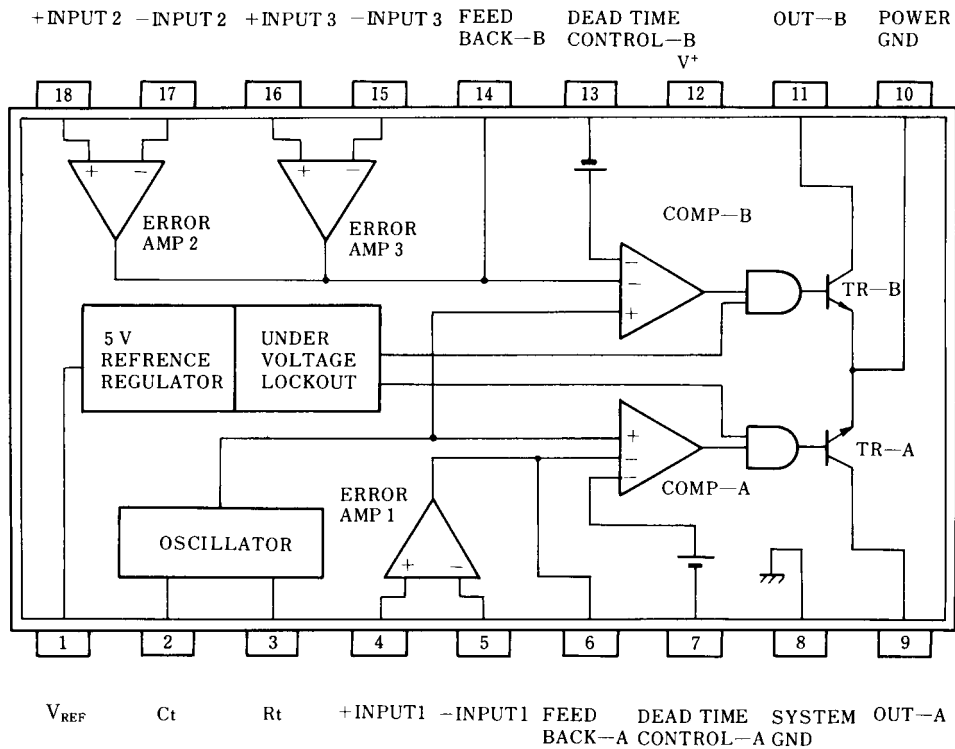

NJM2355D

■ ABSOLUTE MAXIMUM RATINGS

(T_a = 25°C)

PARAMETER	SYMBOL	RATINGS	UNIT
Supply Voltage	V ⁺	24	V
Output Current 1	I _{o1}	200	mA
Output Current 2	I _{o2}	200	mA
Power Dissipation	P _D	700	mW
Operating Temperature Range	T _{opr}	-20 to +75	°C
Storage Temperature Range	T _{stg}	-40 to +125	°C

■ ELECTRICAL CHARACTERISTICS

(T_a = 25°C, V⁺ = 15V)

PARAMETER	SYMBOL	TEST CONDITION	MIN.	TYP.	MAX.	UNIT
Operating Current (1)	I _{cc} (1)	V ⁺ = 15V	-	5.7	7.5	mA
Operating Current (2)	I _{cc} (2)	V ⁺ = 50V	-	5.9	8.0	mA

< Reference Section >

PARAMETER	SYMBOL	TEST CONDITION	MIN.	TYP.	MAX.	UNIT
Output Voltage	V _{REF}	I _{REF} = 0mA	4.8	5.0	5.2	V
Line Regulation	REG _{in}	V ⁺ = 7.5V to 50V, I _{REF} = 0mA	-	12	35	mV
Load Regulation	REG _l	I _{REF} = 0mA to 10mA	-	6	15	mV
Output Short Current			-	30	-	mA
Output disable Voltage	V _{nop}	OUT= High Level	-	4.3	4.6	V
Output disable hysteresis Voltage	ΔV _{nop}		-	0.3	-	V

< Oscillator Section >

PARAMETER	SYMBOL	TEST CONDITION	MIN.	TYP.	MAX.	UNIT
Frequency	F _O	C _t = 0.01μF, R _t = 4.3kΩ	25	28	31	kHz

< Dead Interval Adjustment Section >

PARAMETER	SYMBOL	TEST CONDITION	MIN.	TYP.	MAX.	UNIT
Input Bias Current	I _{bd}	DT = 0V	-	-	-10	μA
Maximum Duty (On-time)	ΔTon/T	C _t = 0.01μF, R _t = 4.3kΩ	90	-	-	%
Input Threshold Voltage	V _{th}	Duty Cycle : 0%	2.0	2.5	3.0	V

< PWM Comparator Section >

PARAMETER	SYMBOL	TEST CONDITION	MIN.	TYP.	MAX.	UNIT
Input Threshold Voltage	V _{the}	Duty Cycle : 0%	-	-	4.5	V

■ ELECTRICAL CHARACTERISTICS

<Error Amplifier Section>

($V^+ = 15V, T_a = 25^\circ C$)

PARAMETER	SYMBOL	TEST CONDITION	MIN.	TYP.	MAX.	UNIT
Input Offset Voltage	V_{IO}	FB = 2.5V	-	1	10	mV
Input Offset Current	I_{IO}	FB = 2.5V	-	5	250	nA
Input Bias Current	I_B	FB = 2.5V	-	0.05	1	μA
Common Mode Input Voltage Range	V_{ICM}	$V^+ = 7.5$ to 50V	0	-	$V_{CC}-2$	V
Voltage Gain	A_v	FB = 0.5 to 3.5V	70	100	-	dB
Band Width	f_t	AV = 1	-	800	-	kHz
Common Mode Rejection Ratio	CMR	$V_{CC} = 50V$	65	80	-	dB
Output Sink Current	I_{SINK}	$V_{ID} = 5V, FB = 0.7V$	0.2	0.4	-	mA
Output Source Current	I_{SOURCE}	$V_{ID} = 5V, FB = 3.5V$	-1	-2.5	-	mA

< Output Section >

PARAMETER	SYMBOL	TEST CONDITION	MIN.	TYP.	MAX.	UNIT
Leak Current	I_{CER}	$V_{CE} = 50V$	-	-	100	μA
Saturation Voltage	V_{SAT}	$I_o = 100mA$	-	0.9	1.3	V

■ TERMINAL EXPLANATION

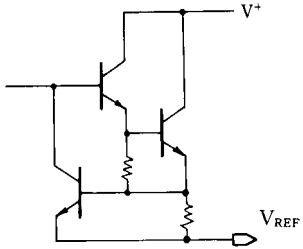
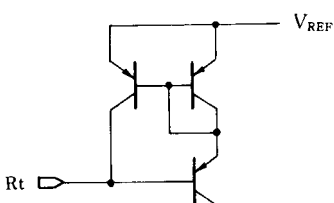
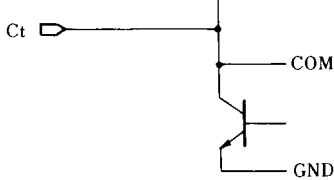
PIN NO.	PIN SYMBOL	FUNCTION	EQUIVALENT CIRCUIT
1.	V_{REF}	5V Reference Voltage Output	
2.	C_t	The oscillator frequency is decided by putting Capacitor, C_t .	
3.	R_t	The oscillator frequency is decided by putting resistor, R_t .	

■ TERMINAL EXPLANATION

PIN NO.	PIN SYMBOL	FUNCTION	EQUIVALENT CIRCUIT
4. 5. 16. 15. 18. 17.	+INPUT1 -INPUT1 +INPUT3 -INPUT3 +INPUT2 -INPUT2	+INPUT of Error Amp 1 (A Channel) -INPUT of Error Amp 1 (A Channel) +INPUT of Error Amp 3 (B Channel) -INPUT of Error Amp 3 (B Channel) +INPUT of Error Amp 2 (B Channel) -INPUT of Error Amp 2 (B Channel)	
6.	FEED BACK-A	OUTPUT of Error Amp 1 (A Channel)	
14.	FEED BACK-B	OUTPUT of Error Amp 2 and Error Amp 3 (B Channel)	

■ TERMINAL EXPLANATION

PIN NO.	PIN SYMBOL	FUNCTION	EQUIVALENT CIRCUIT
7. 13.	DEAD TIME CONTROL-A DEAD TIME CONTROL-B	The Dead Time Width is adjustable by terminal voltage adjust. (A Channel) (B-Channel)	
8.	SYSTEM GND	Ground	
9. 11.	OUT-A OUT-B	Internal Switching Transistor: Open Collector (A Channel) (B-Channel)	
10.	POWER GND	Ground Connect to PIN 8.	
12.	V ^t	Power Supply	

■ TYPICAL APPLICATION

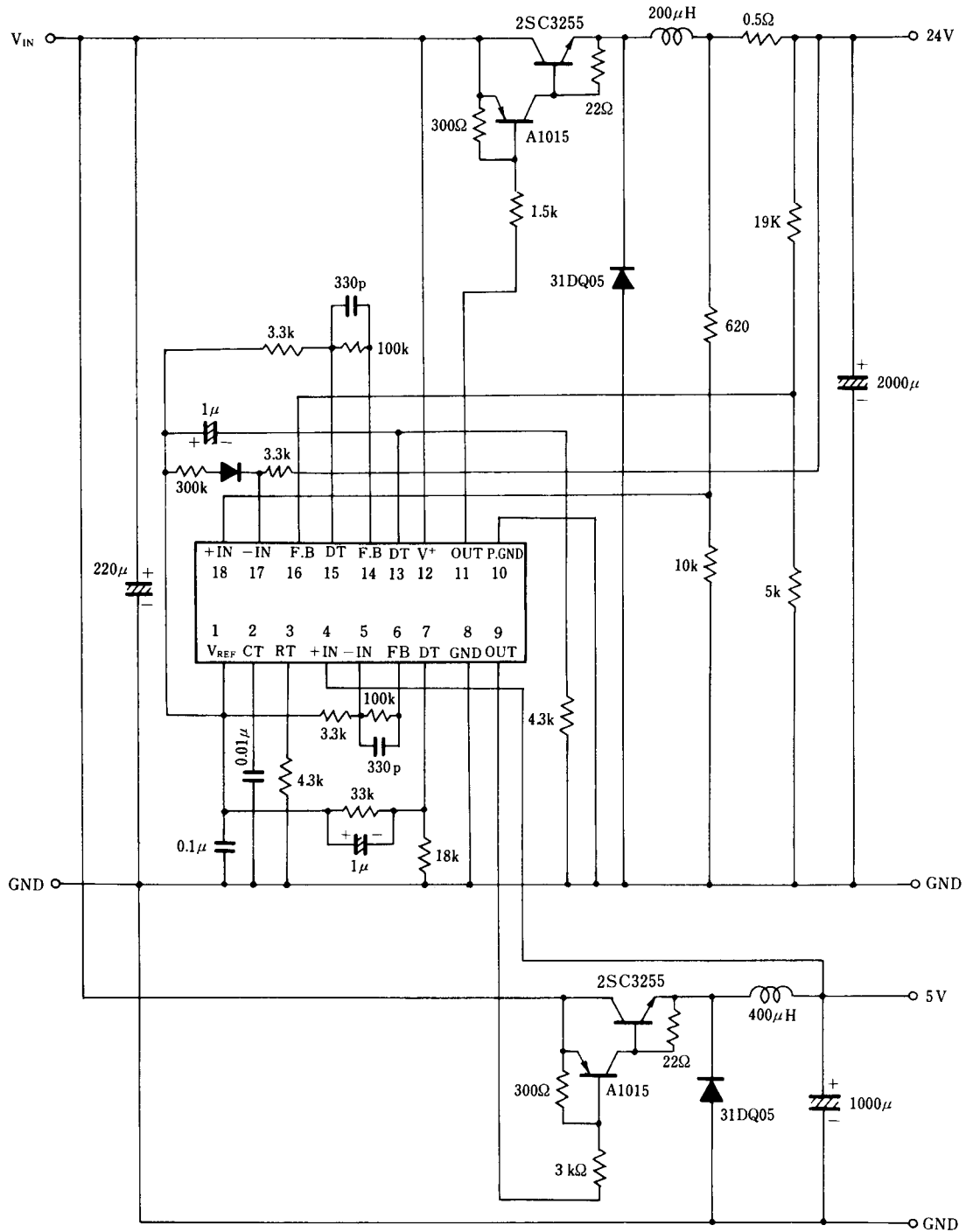

■ TYPICAL CHARACTERISTICS

Output Disable Voltage at Low Input Voltage

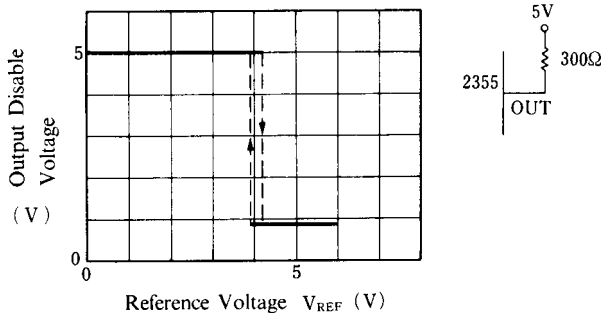

Output Disable Voltage at Low Input Voltage vs. Temperature

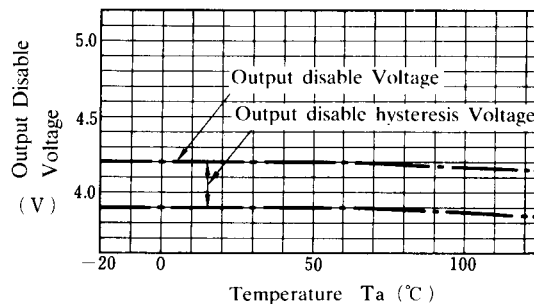

Operating Current vs. Operating Voltage

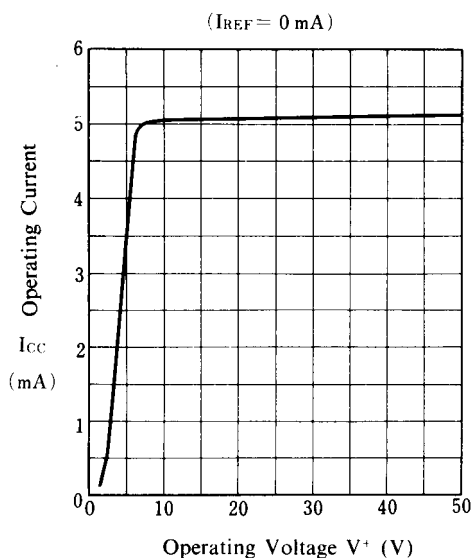

Reference Voltage vs. Operating Voltage

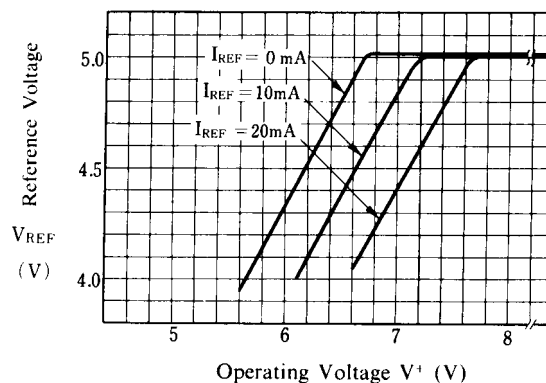

Reference Voltage vs. Temperature

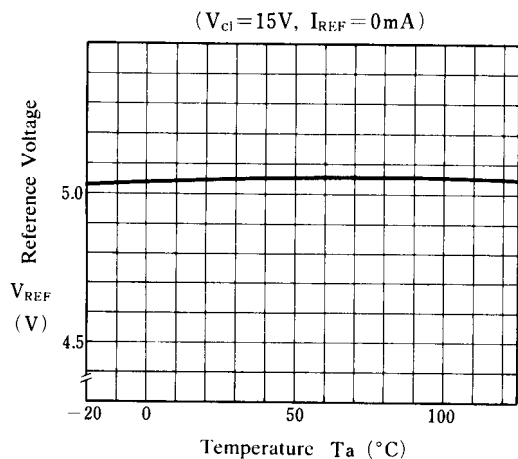

Oscillation Frequency vs. Rt, Ct

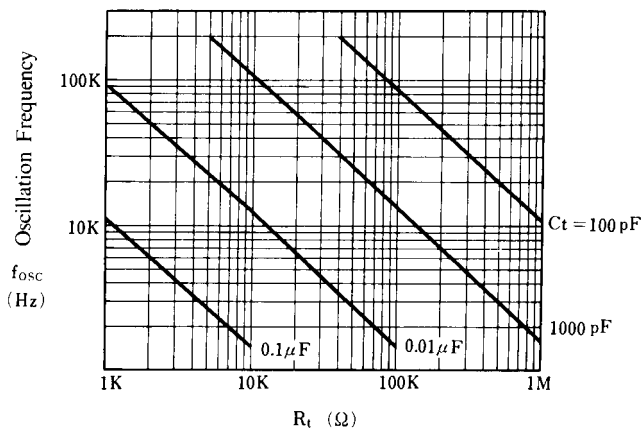

■ TYPICAL CHARACTERISTICS

Oscillation Frequency vs. Temperature

($V^+ = 15V$, $C_T = 1000pF$, $R_T = 30k\Omega$)

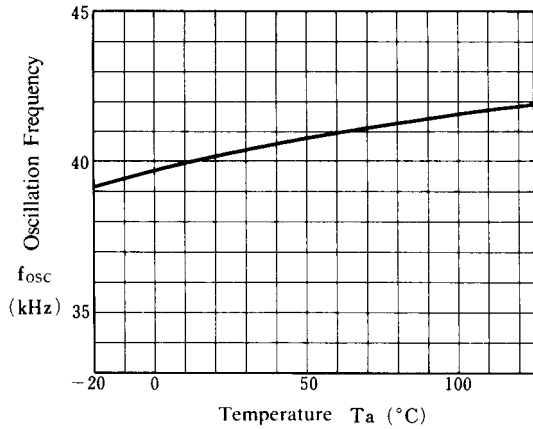

Open Loop Voltage Gain vs. Frequency

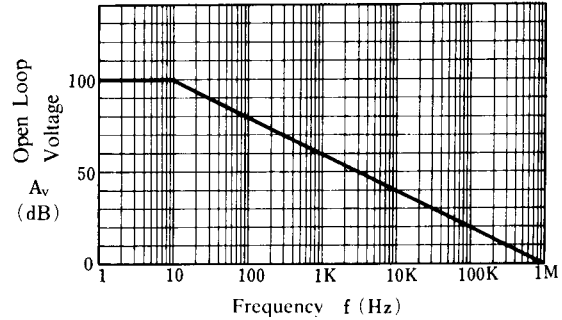

< Error Amplifier Section >

Output Sink Current

vs. Feedback Terminal Voltage

($V^+ = 15V$, $+INPUT = 0V$, $-INPUT = 5V$)

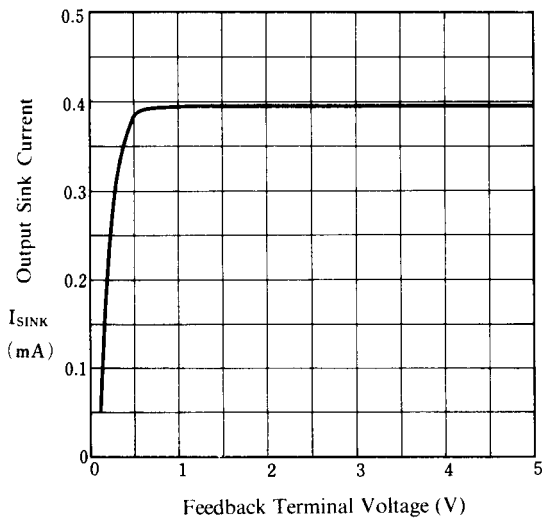

< Error Amplifier Section >

Output Source Current

vs. Feedback Terminal Voltage

($V^+ = 15V$, $+INPUT = 5V$, $-INPUT = 0V$)

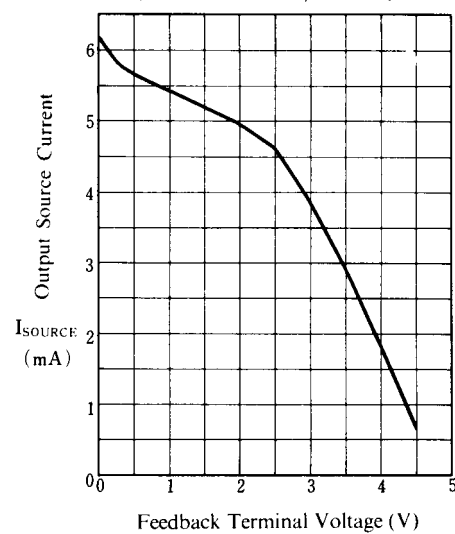

< Error Amplifier Section >

Output Sink Current vs. Temperature

($V^+ = 15V$, $F.B_{PIN} = 0.1V$, $+INPUT = 0V$, $-INPUT = 5V$)

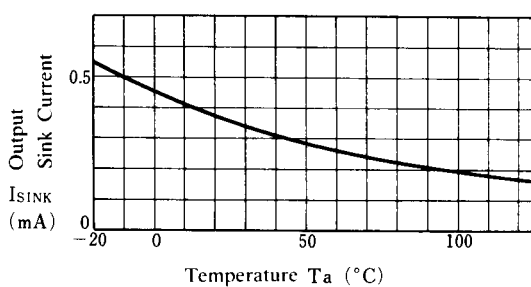

< Error Amplifier Section >

Output Source Current vs. Temperature

($V^+ = 15V$, $F.B_{PIN} = 3.5V$, $+INPUT = 5V$, $-INPUT = 0V$)

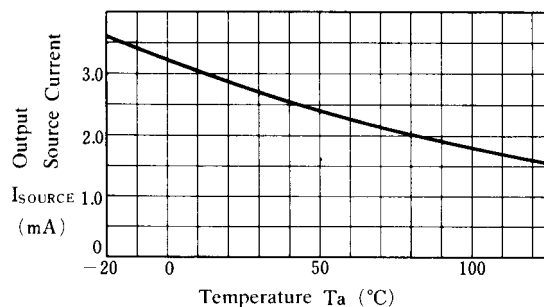

■ TYPICAL CHARACTERISTICS

< Output Section >

Saturation Voltage vs. Output Current
($T_a = 25^\circ\text{C}$)

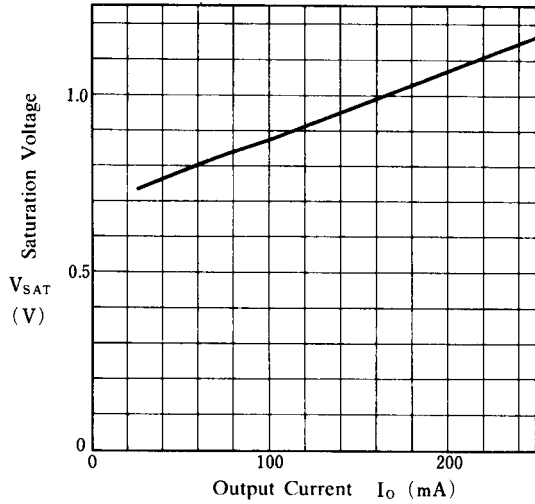

< Output Section >

Saturation Voltage vs. Temperature
($I_O = 100\text{mA}$)

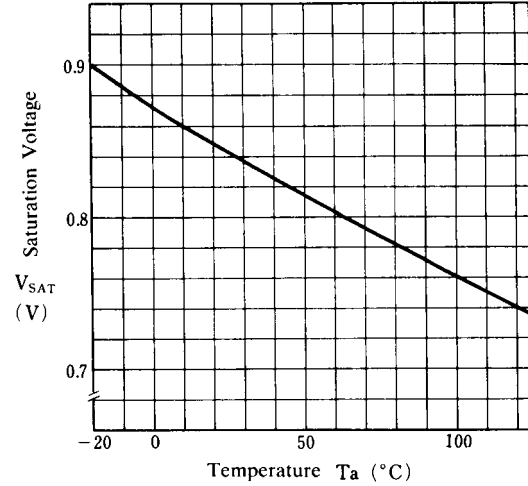

[CAUTION]

The specifications on this databook are only given for information, without any guarantee as regards either mistakes or omissions. The application circuits in this databook are described only to show representative usages of the product and not intended for the guarantee or permission of any right including the industrial rights.