

LOW POWER SUPER SMALL-SIZED SINGLE C-MOS COMPARATOR

■GENERAL DESCRIPTION

The **NJU7109** is super small-sized package single C-MOS comparator with push pull output.

The operating voltage is from 1.8V to 5.5V, and the interface can be connected with most of TTL and C-MOS type standard logic ICs.

Furthermore, The input offset voltage is lower than 7mV and the package is super small-sized SC88A, therefore they can be suitable for battery use items and other portable items.

■PACKAGE INFORMATION



NJU7109F



NJU7109F3

■FEATURES

- Single Low Power Supply
- Low Offset Voltage
- Low Operating Current
- Push Pull Output
- Package Outline
- C-MOS Technology

$V_{DD}=1.8\sim 5.5V$
 $V_{IO}=7mV\ max$
 $I_{DD}=100\mu A$

MTP5, SC88A

■PIN CONFIGURATION

(Top View)

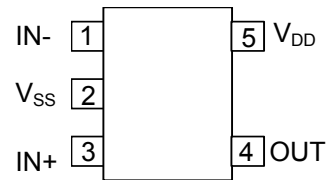

■EQUIVALENT CIRCUIT

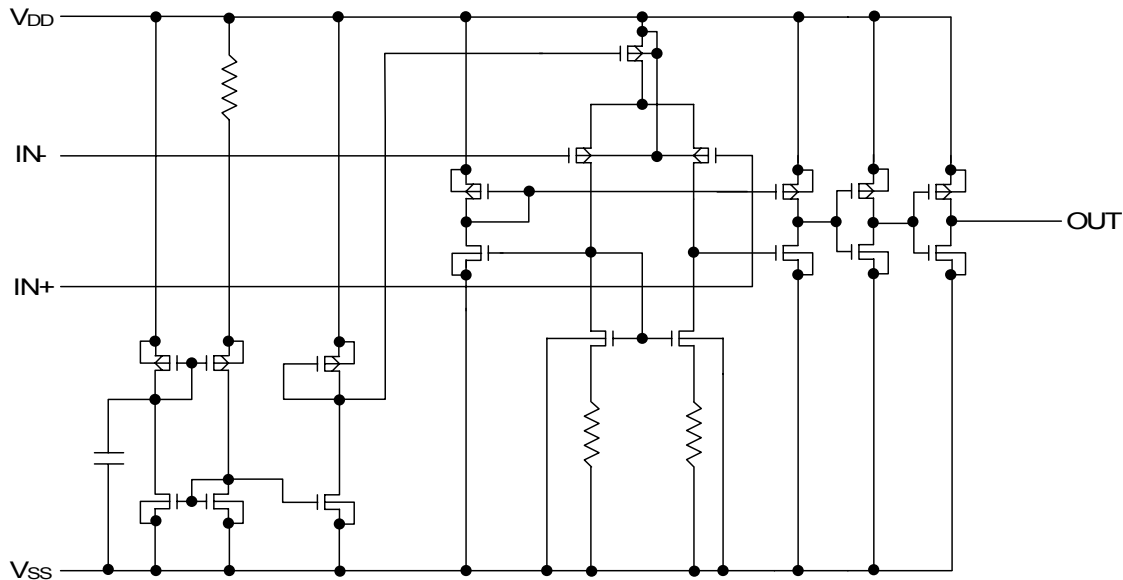

NJU7109

■ABSOLUTE MAXIMUM RATINGS

(Ta=25°C)

PARAMETER	SYMBOL	RATING	UNIT
Supply Voltage	V _{DD}	7.0	V
Differential Input Voltage	V _{ID}	±7.0 (Note1)	V
Common Mode Input Voltage	V _{IC}	-0.3~7.0	V
Power Dissipation	P _D	MTP5: 200 SC88A: 250 (Note2)	mW
Operating Temperature	T _{opr}	-40~+85	°C
Storage Temperature	T _{stg}	-55~+125	°C

Note1) If the supply voltage (V_{DD}) is less than 7.0V, the input voltage must not over the V_{DD} level though 7.0V is limit specified.

Note2) The power dissipation is value mounted on a glass epoxy board (FR-4) in size of 50x50x1.6 millimeters square.

Note3) Decoupling capacitor should be connected between V_{DD} and V_{SS} due to the stabilized operation for the circuit.

■RECOMMENDED OPERATING CONDITION

(V_{DD}=3.0V, Ta=25°C)

PARAMETER	SYMBOL	CONDITIONS	MIN	TYP	MAX	UNIT
Operating Voltage	V _{DD}		1.8	-	5.5	V

■DC CHARACTERISTICS

(V_{DD}=3.0V, R_L=∞, Ta=25°C)

PARAMETER	SYMBOL	CONDITIONS	MIN	TYP	MAX	UNIT
Operating Current	I _{DD}		-	100	200	μA
Input Offset Voltage	V _{IO}	V _{IN} =V _{DD} /2	-	-	7	mV
Input Offset Current	I _{IO}		-	1	-	pA
Input Bias Current	I _{IB}		-	1	-	pA
High Level Output Voltage	V _{OH}	I _{OH} =-5mA	2.7	-	-	V
Low Level Output Voltage	V _{OL}	I _{OL} =+5mA	-	-	0.3	V
Input Common Mode Voltage Range	V _{ICM}		0~2.4	-	-	V

■TRANSIENT CHARACTERISTICS

(V_{DD}=3.0V, f=10kHz, C_L=15pF, Ta=25°C)

PARAMETER	SYMBOL	CONDITIONS	MIN	TYP	MAX	UNIT
Propagation Delay Low to High	t _{PLH}	Over Drive=100mV	-	110	-	ns
Propagation Delay High to Low	t _{PHL}	Over Drive=100mV	-	70	-	ns
Output Signal Rising Time	t _{TLH}	Over Drive=100mV	-	7	-	ns
Output Signal Falling Time	t _{THL}	Over Drive=100mV	-	6	-	ns

■ TYPICAL CHARACTERISTICS

Operating Current vs. Operating Voltage

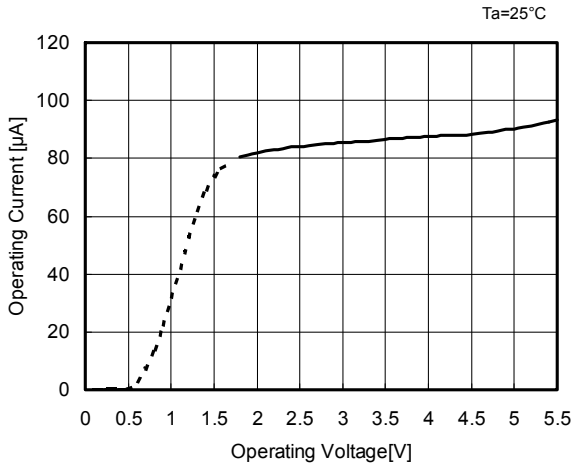

Operating Current vs. Operating Voltage

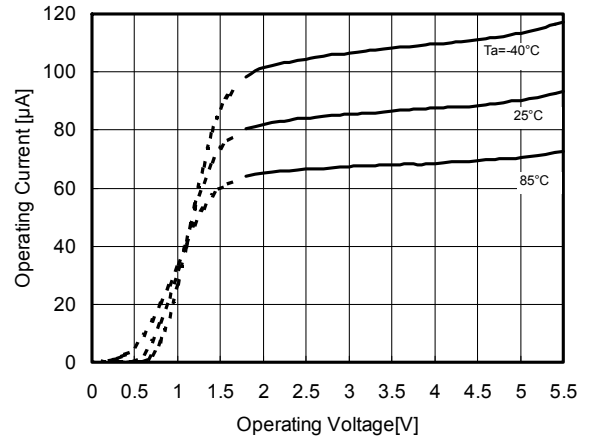

Operating Current vs. Ambient Temperature

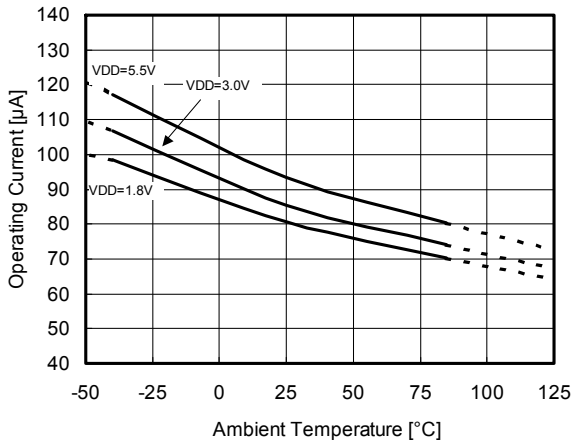

Input Offset Voltage vs. Operating Voltage

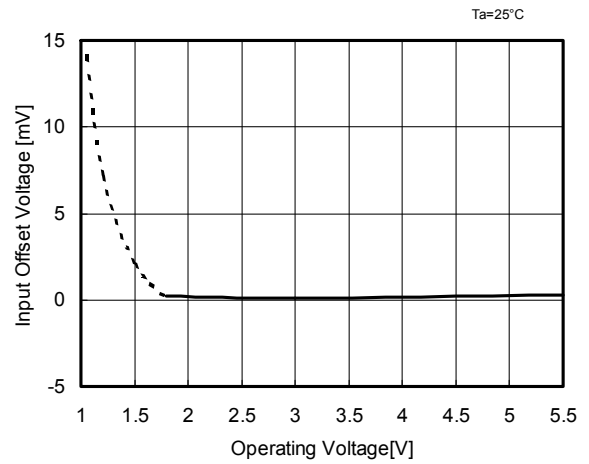

Input Offset Voltage vs. Operating Voltage
(correlation with Ta)

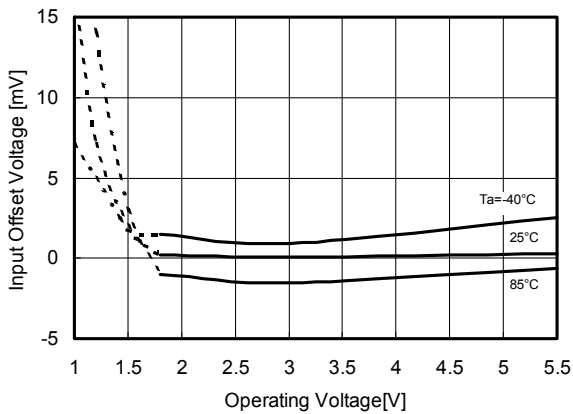

Input Offset Voltage vs. Ambient Temperature

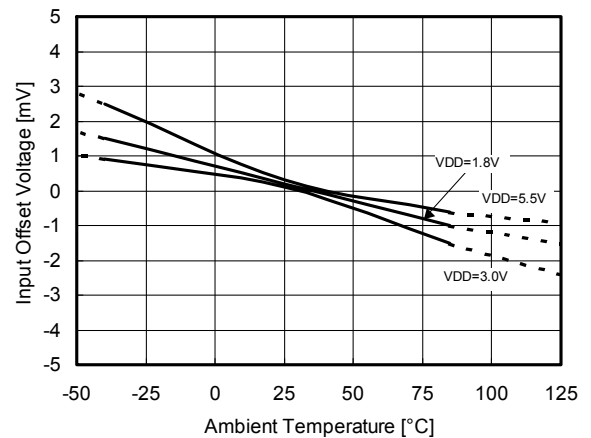

TYPICAL CHARACTERISTICS

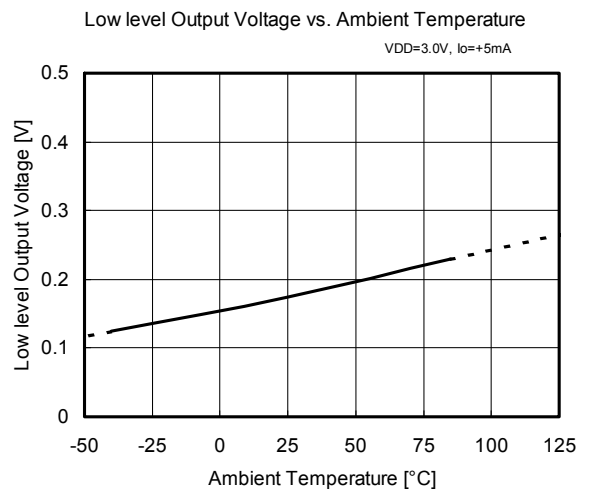
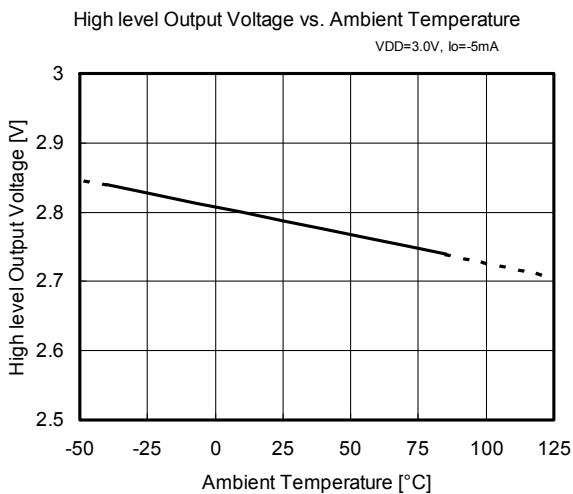
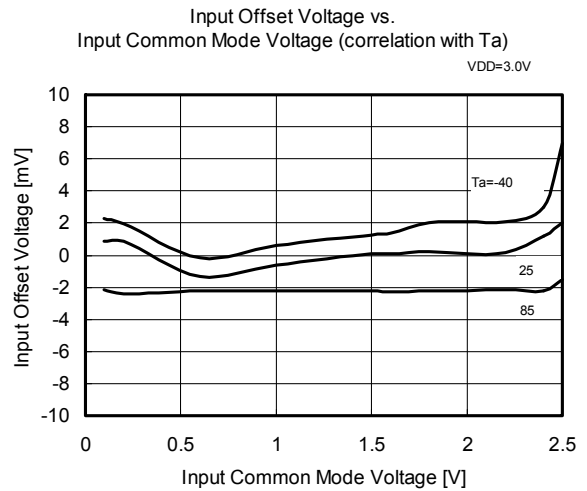
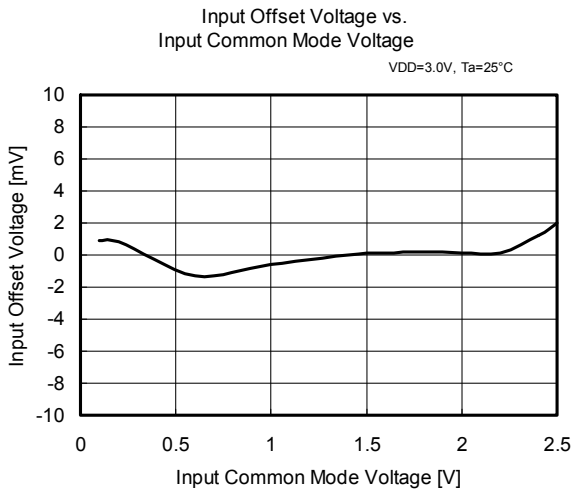
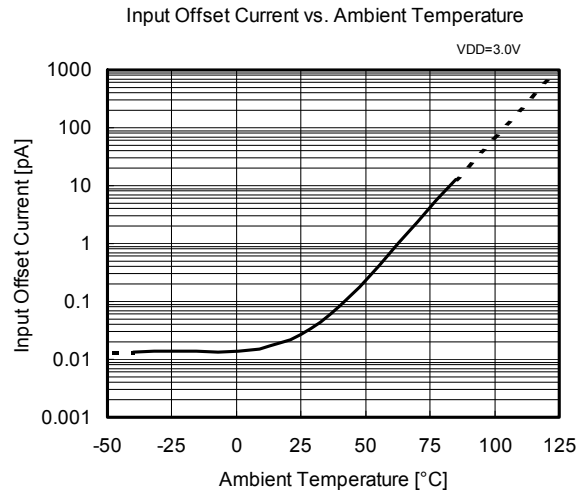
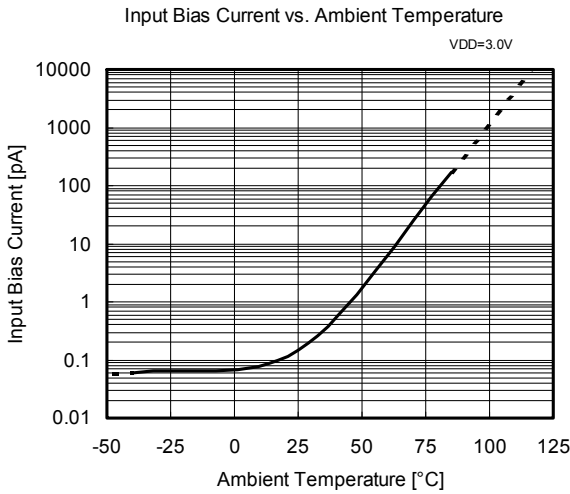

■ TYPICAL CHARACTERISTICS

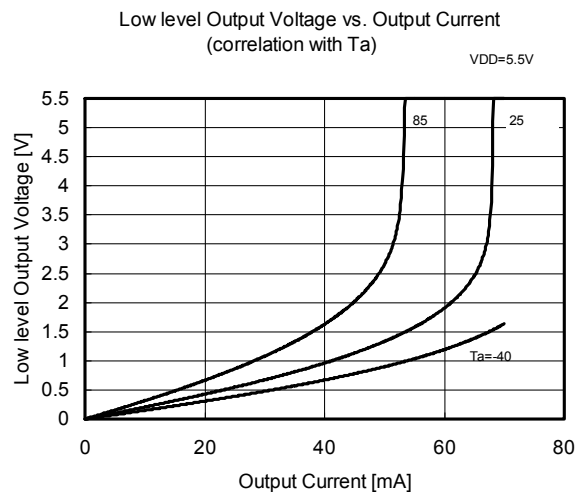
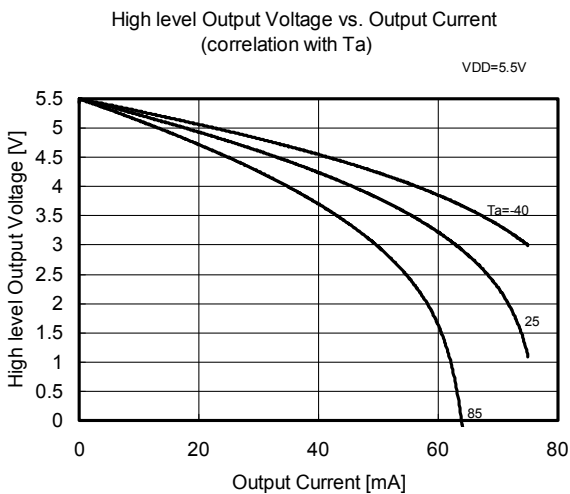
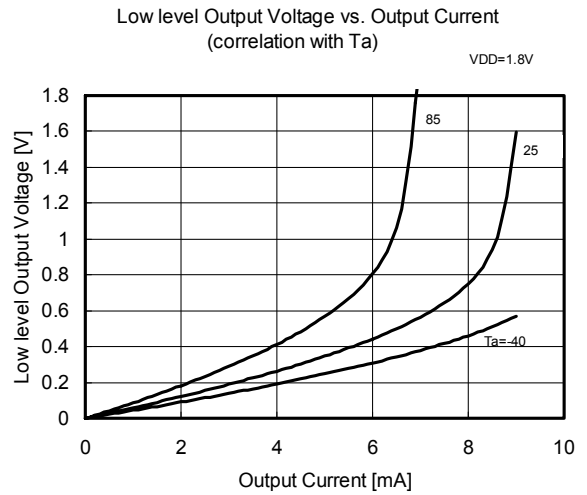
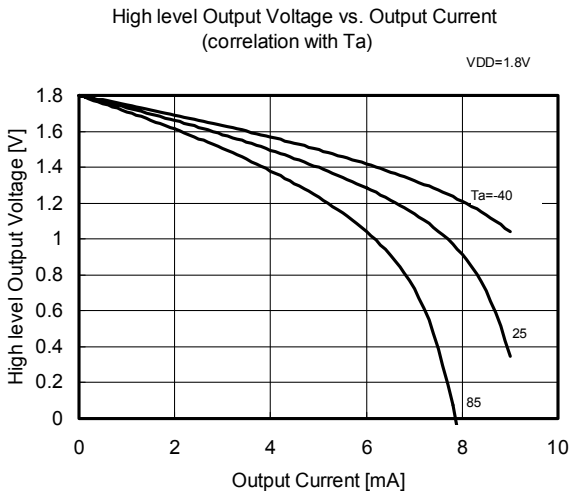
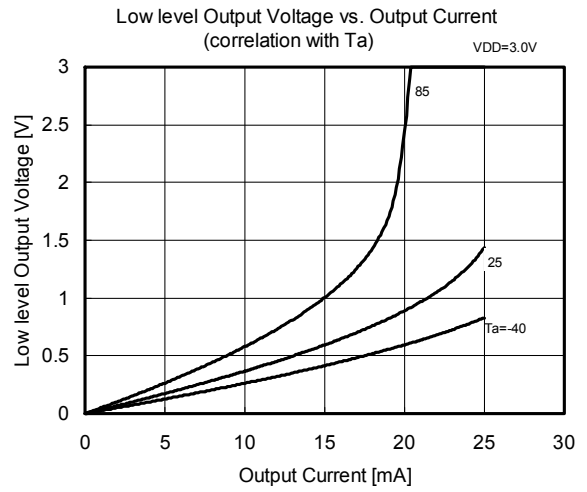
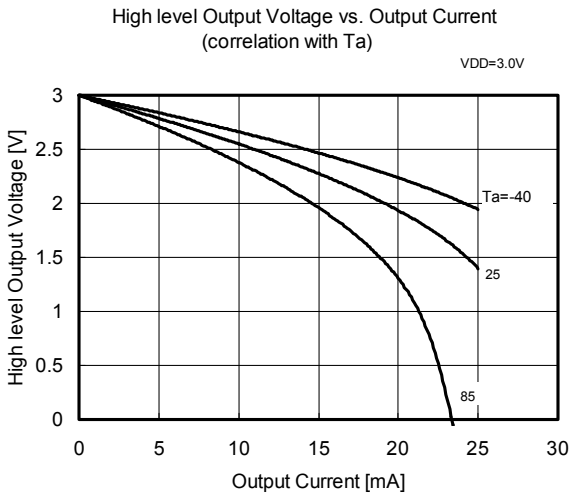

TYPICAL CHARACTERISTICS

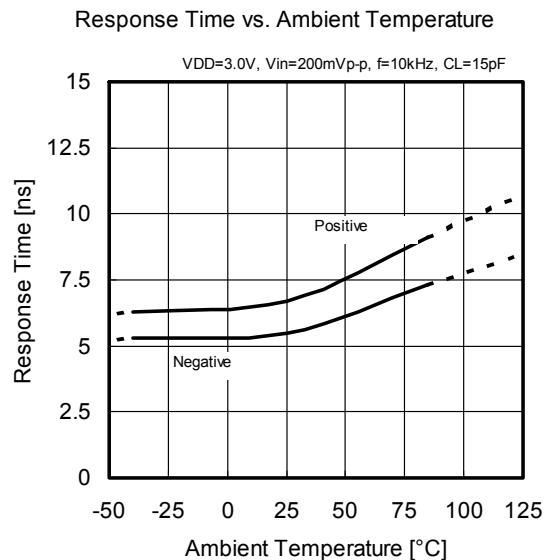
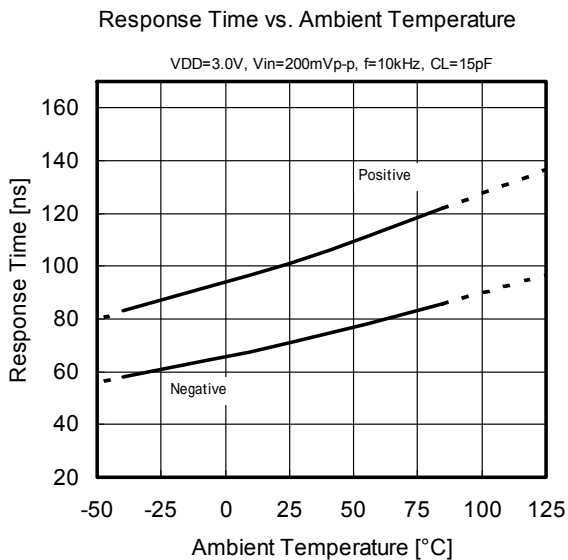
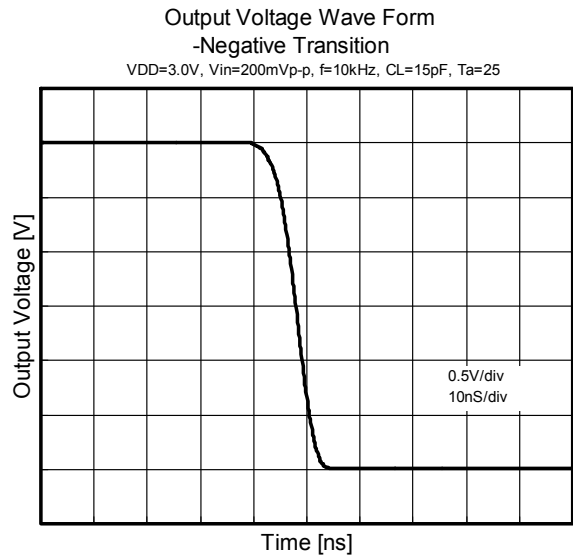
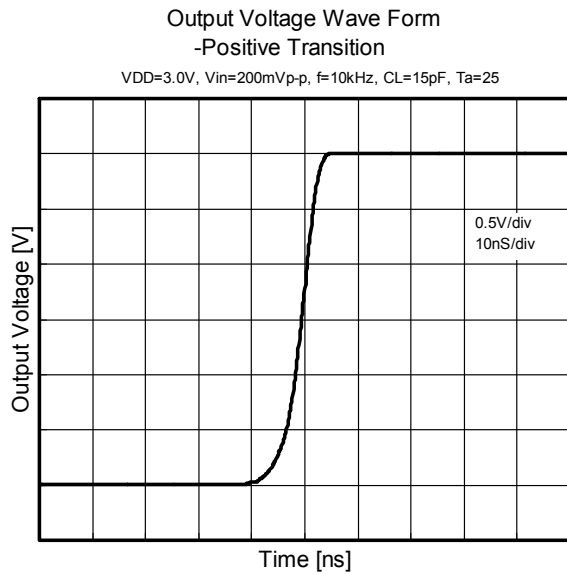
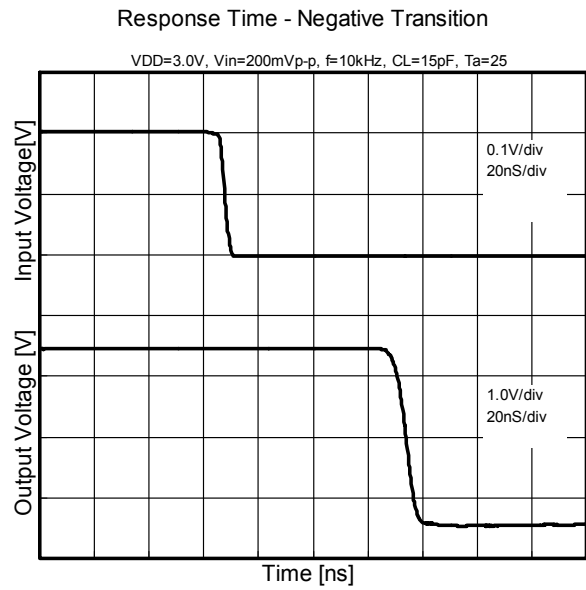
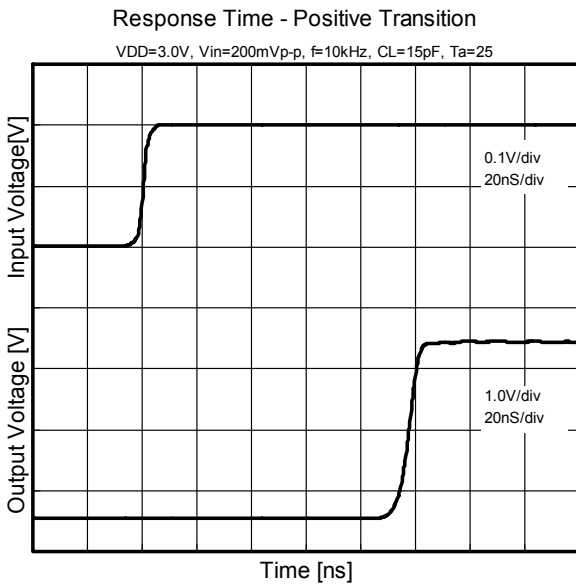

■ SWITCHING CHARACTERISTICS MEASUREMENT CIRCUIT

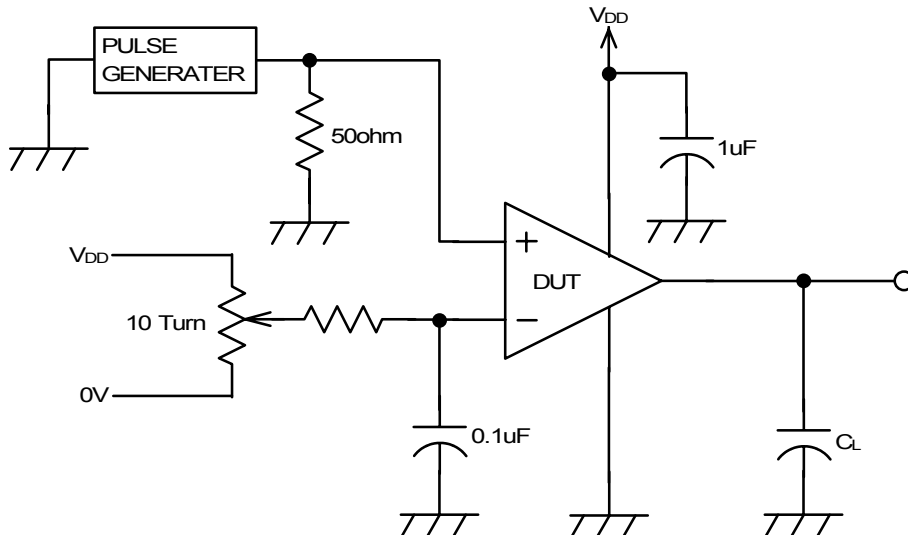

[CAUTION]
 The specifications on this data book are only given for information, without any guarantee as regards either mistakes or omissions. The application circuits in this data book are described only to show representative usages of the product and not intended for the guarantee or permission of any right including the industrial rights.