

# 74ABT541

Octal buffer/line driver; 3-state

Rev. 3 — 11 August 2014

Product data sheet

## 1. General description

The 74ABT541 high-performance BiCMOS device combines low static and dynamic power dissipation with high speed and high output drive.

The 74ABT541 device is an octal buffer that is ideal for driving bus lines. The outputs are all capable of sinking 64 mA and sourcing 32 mA. The device features input and outputs on opposite sides of the package to facilitate printed circuit board layout.

## 2. Features and benefits

- Octal bus interface
- Functions similar to the 74ABT241
- Provides ideal interface and increases fan-out of MOS microprocessors
- Efficient pinout to facilitate PC board layout
- 3-State buffer outputs sink 64 mA and source 32 mA
- Live insertion/extraction permitted
- Power-up 3-state
- Latch-up protection exceeds 500 mA per JESD78 class II level A
- ESD protection:
  - ◆ HBM JESD22-A114E exceeds 2000 V
  - ◆ MM JESD22-A115-A exceeds 200 V

## 3. Ordering information

Table 1. Ordering information

Type number	Package			
	Temperature range	Name	Description	Version
74ABT541N	−40 °C to +85 °C	DIP20	plastic dual in-line package; 20 leads (300 mil)	SOT146-1
74ABT541D	−40 °C to +85 °C	SO20	plastic small outline package; 20 leads; body width 7.5 mm	SOT163-1
74ABT541DB	−40 °C to +85 °C	SSOP20	plastic shrink small outline package; 20 leads; body width 5.3 mm	SOT339-1
74ABT541PW	−40 °C to +85 °C	TSSOP20	plastic thin shrink small outline package; 20 leads; body width 4.4 mm	SOT360-1



### 4. Functional diagram

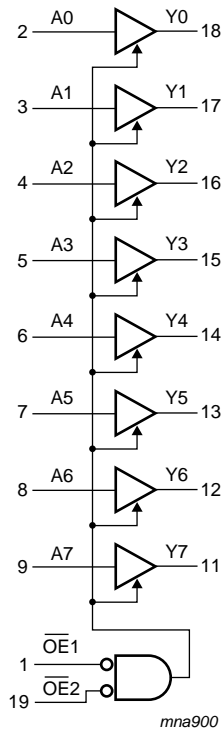

Fig 1. Logic symbol

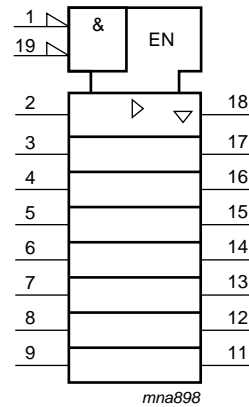

Fig 2. IEC logic symbol

### 5. Pinning information

#### 5.1 Pinning

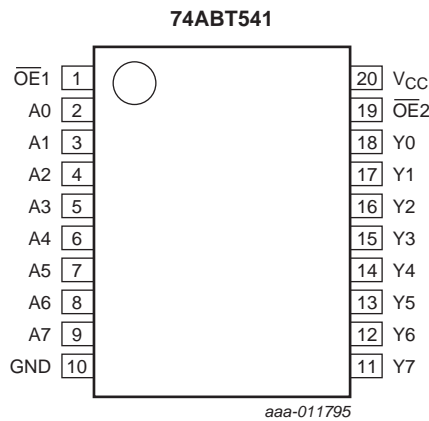

Fig 3. Pin configuration for SO20 and (T)SSOP20

## 5.2 Pin description

Table 2. Pin description

Symbol	Pin	Description
$\overline{OE}1, \overline{OE}2$	1, 19	output enable input (active LOW)
A[0:7]	2, 3, 4, 5, 6, 7, 8, 9	data input
GND	10	ground (0 V)
Y[0:7]	18, 17, 16, 15, 14, 13, 12, 11	data output
V <sub>CC</sub>	20	supply voltage

## 6. Functional description

Table 3. Functional table<sup>[1]</sup>

Control		Input	Output
$\overline{OE}1$	$\overline{OE}2$	A <sub>n</sub>	Y <sub>n</sub>
L	L	L	L
L	L	H	H
X	H	X	Z
H	X	X	Z

[1] H = HIGH voltage level; L = LOW voltage level; X = don't care; Z = high-impedance OFF-state.

## 7. Limiting values

Table 4. Limiting values<sup>[3]</sup>

In accordance with the Absolute Maximum Rating System (IEC 60134). Voltages are referenced to GND (ground = 0 V).

Symbol	Parameter	Conditions	Min	Max	Unit
V <sub>CC</sub>	supply voltage		-0.5	+7.0	V
V <sub>I</sub>	input voltage		<sup>[1]</sup> -1.2	+7.0	V
V <sub>O</sub>	output voltage	output in OFF-state or HIGH-state	<sup>[2]</sup> -0.5	+5.5	V
I <sub>IK</sub>	input clamping current	V <sub>I</sub> < 0 V	-18	-	mA
I <sub>OK</sub>	output clamping current	V <sub>O</sub> < 0 V	-50	-	mA
I <sub>O</sub>	output current	output in LOW-state	-	128	mA
T <sub>j</sub>	junction temperature		<sup>[3]</sup> -	150	°C
T <sub>stg</sub>	storage temperature		-65	+150	°C
P <sub>tot</sub>	total power dissipation	T <sub>amb</sub> = -40 °C to +85 °C	<sup>[4]</sup> -	500	mW

[1] The minimum input voltage ratings may be exceeded if the input current ratings are observed.

[2] The output voltage ratings may be exceeded if the output current ratings are observed.

[3] The performance capability of a high-performance integrated circuit in conjunction with its thermal environment can create junction temperatures which are detrimental to reliability.

[4] For SO20 packages: above 70 °C the value of P<sub>tot</sub> derates linearly with 8 mW/K.  
For (T)SSOP20 packages: above 60 °C the value of P<sub>tot</sub> derates linearly with 5.5 mW/K.

## 8. Recommended operating conditions

**Table 5. Operating conditions**

Voltages are referenced to GND (ground = 0 V).

Symbol	Parameter	Conditions	Min	Typ	Max	Unit
$V_{CC}$	supply voltage		4.5	-	5.5	V
$V_I$	input voltage		0	-	$V_{CC}$	V
$V_{IH}$	HIGH-level input voltage		2.0	-	-	V
$V_{IL}$	LOW-level input voltage		-	-	0.8	V
$I_{OH}$	HIGH-level output current		-32	-	-	mA
$I_{OL}$	LOW-level output current		-	-	64	mA
$\Delta t/\Delta V$	input transition rise and fall rate		0	-	5	ns/V
$T_{amb}$	ambient temperature	in free air	-40	-	+85	°C

## 9. Static characteristics

**Table 6. Static characteristics**

At recommended operating conditions. Voltages are referenced to GND (ground = 0 V).

Symbol	Parameter	Conditions	25 °C			-40 °C to +85 °C		Unit
			Min	Typ	Max	Min	Max	
$V_{IK}$	input clamping voltage	$V_{CC} = 4.5\text{ V}; I_{IK} = -18\text{ mA}$	-	-0.9	-1.2	-	-1.2	V
$V_{OH}$	HIGH-level output voltage	$V_I = V_{IL}$ or $V_{IH}$						
		$V_{CC} = 4.5\text{ V}; I_{OH} = -3\text{ mA}$	2.5	2.9	-	2.5	-	V
		$V_{CC} = 5.0\text{ V}; I_{OH} = -3\text{ mA}$	3.0	3.4	-	3.0	-	V
		$V_{CC} = 4.5\text{ V}; I_{OH} = -32\text{ mA}$	2.0	2.4	-	2.0	-	V
$V_{OL}$	LOW-level output voltage	$V_{CC} = 4.5\text{ V}; I_{OL} = 64\text{ mA};$ $V_I = V_{IL}$ or $V_{IH}$	-	0.42	0.55	-	0.55	V
$I_I$	input leakage current	$V_{CC} = 5.5\text{ V}; V_I = \text{GND}$ or $5.5\text{ V}$	-	$\pm 0.01$	$\pm 1.0$	-	$\pm 1.0$	$\mu\text{A}$
$I_{OFF}$	power-off leakage current	$V_{CC} = 0.0\text{ V}; V_I$ or $V_O \leq 4.5\text{ V}$	-	$\pm 5.0$	$\pm 100$	-	$\pm 100$	$\mu\text{A}$
$I_{O(pu/pd)}$	power-up/power-down output current	$V_{CC} = 2.0\text{ V}; V_O = 0.5\text{ V};$ $V_I = \text{GND}$ or $V_{CC}; \overline{OE} = \text{don't care}$ <sup>[1]</sup>	-	$\pm 5.0$	$\pm 50$	-	$\pm 50$	$\mu\text{A}$
$I_{OZ}$	OFF-state output current	$V_{CC} = 5.5\text{ V}; V_I = V_{IL}$ or $V_{IH}$						
		$V_O = 2.7\text{ V}$	-	5.0	50	-	50	$\mu\text{A}$
		$V_O = 0.5\text{ V}$	-	-5.0	-50	-	-50	$\mu\text{A}$
$I_{LO}$	output leakage current	HIGH-state; $V_O = 5.5\text{ V};$ $V_{CC} = 5.5\text{ V}; V_I = \text{GND}$ or $V_{CC}$	-	5.0	50	-	50	$\mu\text{A}$
$I_O$	output current	$V_{CC} = 5.5\text{ V}; V_O = 2.5\text{ V}$ <sup>[2]</sup>	-40	-100	-180	-40	-180	mA
$I_{CC}$	supply current	$V_{CC} = 5.5\text{ V}; V_I = \text{GND}$ or $V_{CC}$						
		outputs HIGH-state	-	0.5	250	-	250	$\mu\text{A}$
		outputs LOW-state	-	24	30	-	30	mA
		outputs disabled	-	0.5	250	-	250	$\mu\text{A}$

**Table 6. Static characteristics ...continued**

At recommended operating conditions. Voltages are referenced to GND (ground = 0 V).

Symbol	Parameter	Conditions	25 °C			-40 °C to +85 °C		Unit
			Min	Typ	Max	Min	Max	
$\Delta I_{CC}$	additional supply current	per input pin; output enabled; <sup>[3]</sup> $V_{CC} = 5.5 \text{ V}$ ; one input at 3.4 V, other inputs at $V_{CC}$ or GND	-	0.5	1.5	-	1.5	mA
		per input pin; output disabled; $V_{CC} = 5.5 \text{ V}$ ; one data input at 3.4 V, other inputs at $V_{CC}$ or GND	-	0.5	50	-	50	$\mu\text{A}$
		per input pin; output disabled; $V_{CC} = 5.5 \text{ V}$ ; one enable input at 3.4 V, other inputs at $V_{CC}$ or GND	-	0.5	1.5	-	1.5	mA
$C_I$	input capacitance	$V_I = 0 \text{ V}$ or $V_{CC}$	-	4	-	-	-	pF
$C_O$	output capacitance	outputs disabled; $V_O = 0 \text{ V}$ or $V_{CC}$	-	7	-	-	-	pF

[1] This parameter is valid for any  $V_{CC}$  between 0 V and 2.1 V, with a transition time of up to 10 ms. From  $V_{CC} = 2.1 \text{ V}$  to  $V_{CC} = 5 \text{ V} \pm 10 \%$ , a transition time of up to 100  $\mu\text{s}$  is permitted.

[2] Not more than one output should be tested at a time, and the duration of the test should not exceed one second.

[3] This is the increase in supply current for each input at 3.4 V.

## 10. Dynamic characteristics

**Table 7. Dynamic characteristics**GND = 0 V. Test circuit is shown in [Figure 6](#).

Symbol	Parameter	Conditions	25 °C; $V_{CC} = 5.0 \text{ V}$			-40 °C to +85 °C; $V_{CC} = 5.0 \text{ V} \pm 0.5 \text{ V}$		Unit
			Min	Typ	Max	Min	Max	
$t_{PLH}$	LOW to HIGH propagation delay	$A_n$ to $Y_n$ , see <a href="#">Figure 4</a>	1.0	2.6	4.1	1.0	4.6	ns
$t_{PHL}$	HIGH to LOW propagation delay	$A_n$ to $Y_n$ , see <a href="#">Figure 4</a>	1.0	2.9	4.2	1.0	4.6	ns
$t_{PZH}$	OFF-state to HIGH propagation delay	$\overline{OEn}$ to $Y_n$ ; see <a href="#">Figure 5</a>	1.1	3.1	4.8	1.1	5.3	ns
$t_{PZL}$	OFF-state to LOW propagation delay	$\overline{OEn}$ to $Y_n$ ; see <a href="#">Figure 5</a>	2.1	4.4	5.9	2.1	6.4	ns
$t_{PHZ}$	HIGH to OFF-state propagation delay	$\overline{OEn}$ to $Y_n$ ; see <a href="#">Figure 5</a>	2.1	5.1	6.6	2.1	7.1	ns
$t_{PLZ}$	LOW to OFF-state propagation delay	$\overline{OEn}$ to $Y_n$ ; see <a href="#">Figure 5</a>	1.7	4.7	6.2	1.7	6.7	ns

11. AC waveforms

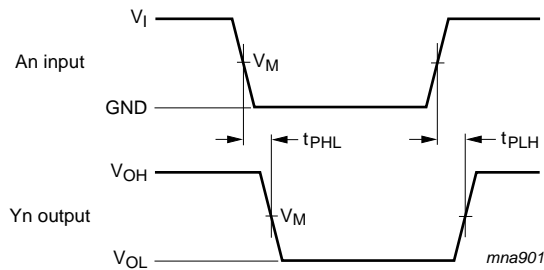

$V_M = 1.5\text{ V}$

$V_{OL}$  and  $V_{OH}$  are typical voltage output levels that occur with the output load.

**Fig 4. Input (An) to output (Yn) propagation delays**

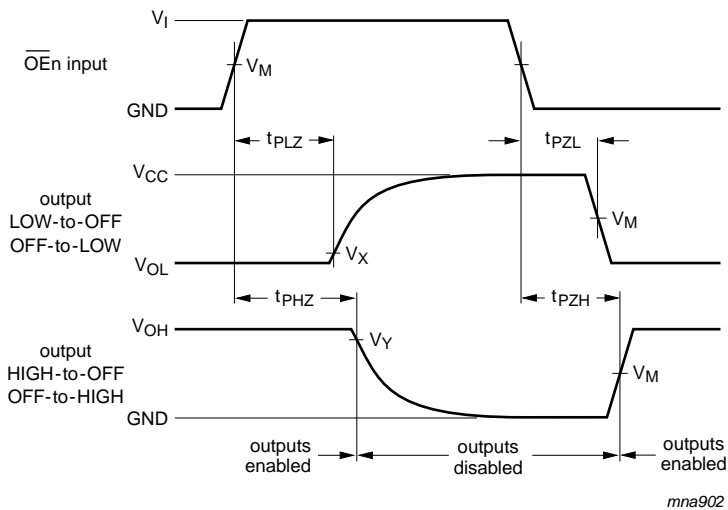

$V_M = 1.5\text{ V}$

$V_{OL}$  and  $V_{OH}$  are typical voltage output levels that occur with the output load.

**Fig 5. 3-state enable and disable times**

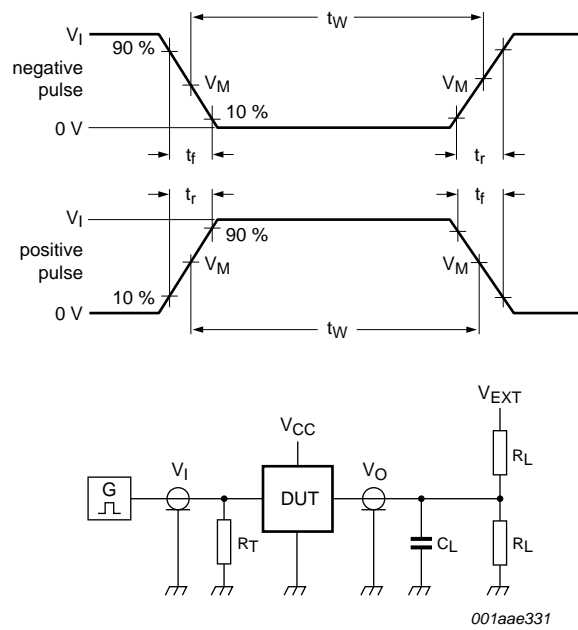

Test data is given in [Table 8](#).

Test circuit definitions:

$R_L$  = Load resistance.

$C_L$  = Load capacitance including jig and probe capacitance.

$R_T$  = Termination resistance should be equal to output impedance  $Z_o$  of the pulse generator.

$V_{EXT}$  = Test voltage for switching times.

**Fig 6. Test circuit for measuring switching times**

**Table 8. Test data**

Input				Load		$V_{EXT}$		
$V_I$	$f_I$	$t_W$	$t_r, t_f$	$C_L$	$R_L$	$t_{PHL}, t_{PLH}$	$t_{PZH}, t_{PHZ}$	$t_{PZL}, t_{PLZ}$
3.0 V	1 MHz	500 ns	$\leq 2.5$ ns	50 pF	500 $\Omega$	open	open	7.0 V

12. Package outline

DIP20: plastic dual in-line package; 20 leads (300 mil)

SOT146-1

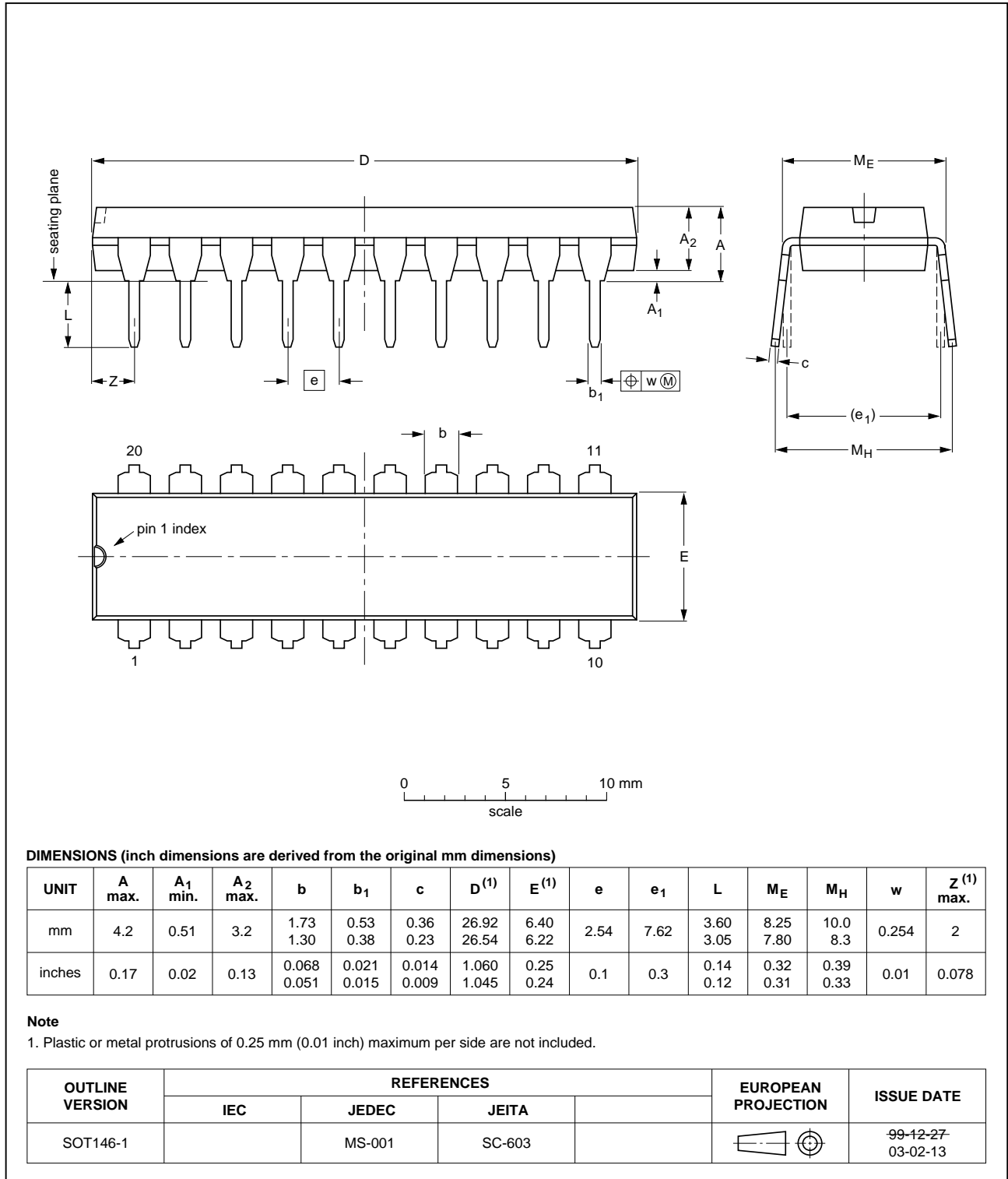

Fig 7. Package outline SOT146-1 (DIP20)



SO20: plastic small outline package; 20 leads; body width 7.5 mm

SOT163-1

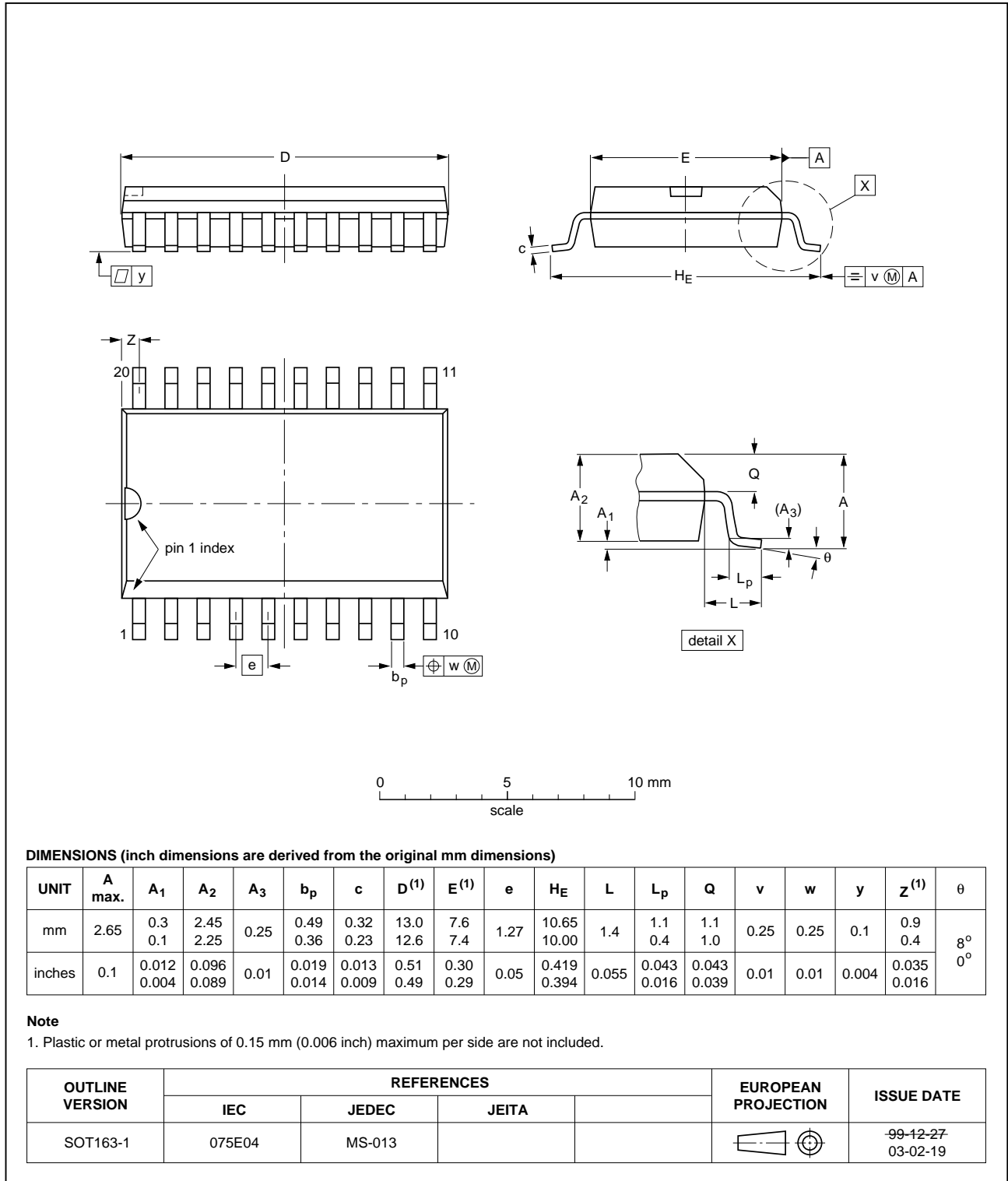

Fig 8. Package outline SOT163-1 (SO20)

SSOP20: plastic shrink small outline package; 20 leads; body width 5.3 mm

SOT339-1

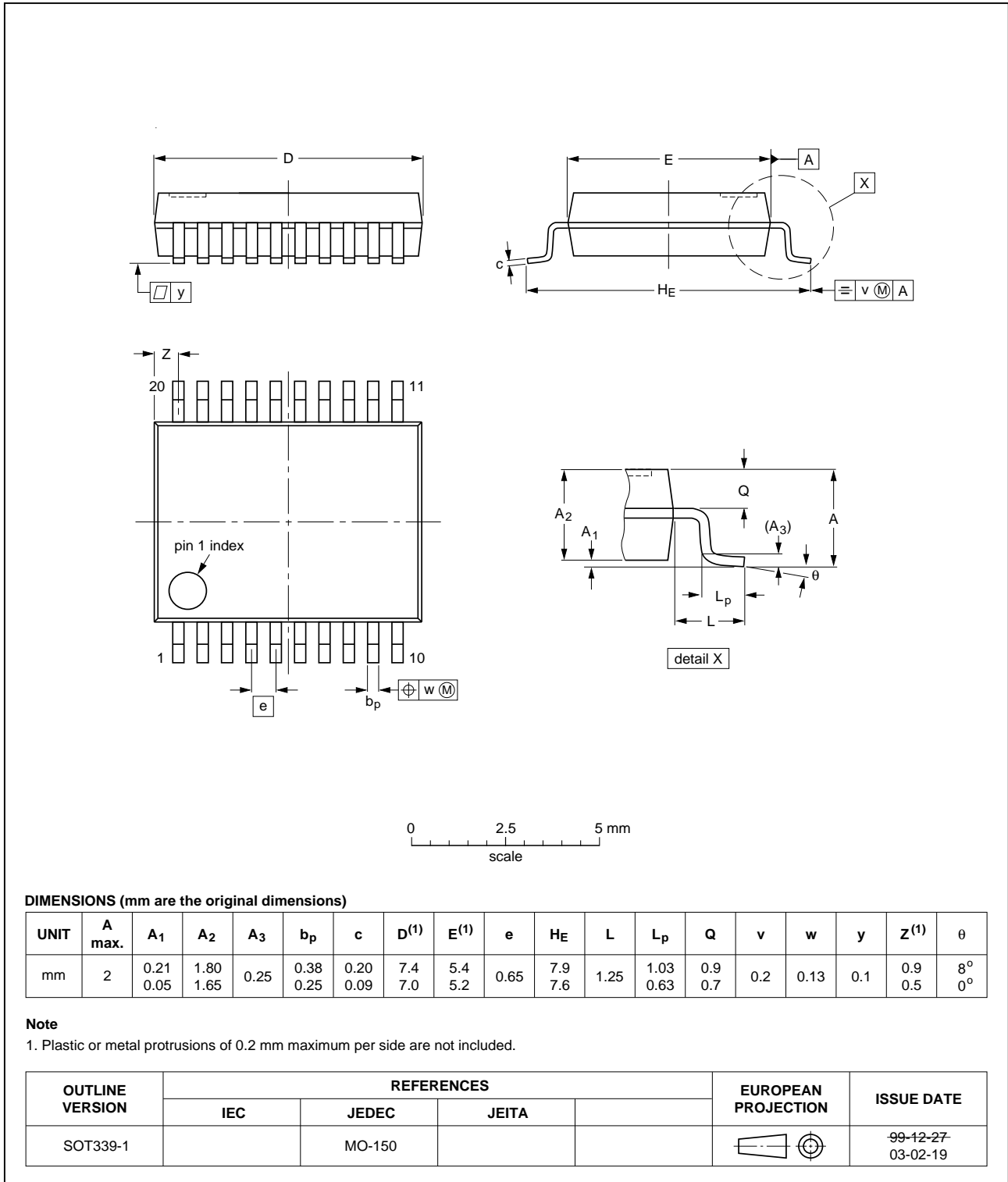

Fig 9. Package outline SOT339-1 (SSOP20)

TSSOP20: plastic thin shrink small outline package; 20 leads; body width 4.4 mm

SOT360-1

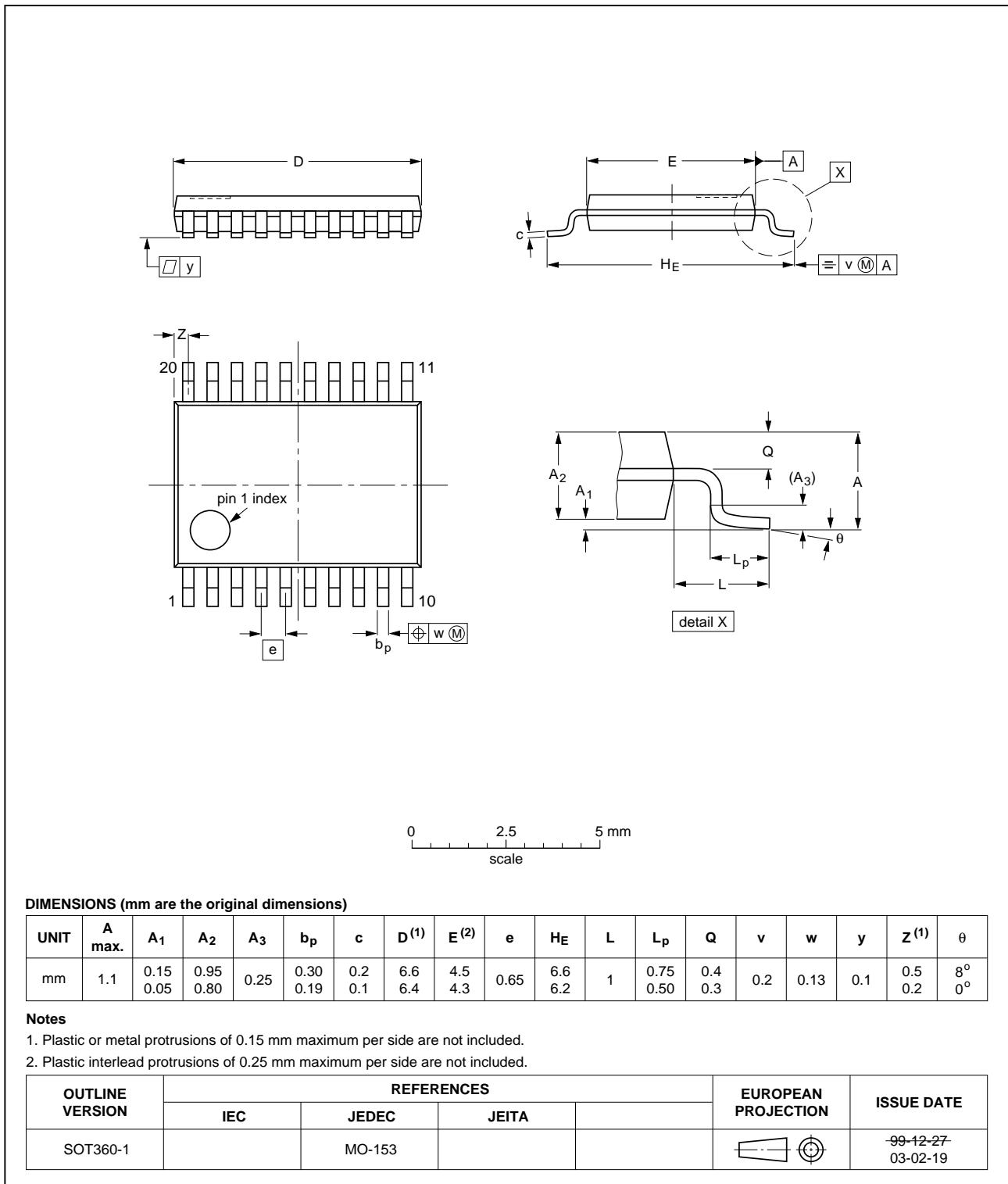

Fig 10. Package outline SOT360-1 (TSSOP20)

## 13. Abbreviations

Table 9. Abbreviations

Acronym	Description
BiCMOS	Bipolar Complementary Metal-Oxide Semiconductor
CDM	Charged Device Model
DUT	Device Under Test
ESD	ElectroStatic Discharge
HBM	Human Body Model
MM	Machine Model

## 14. Revision history

Table 10. Revision history

Document ID	Release date	Data sheet status	Change notice	Supersedes
74ABT541 v.3	20140811	Product data sheet	-	74ABT541 v.2
Modifications:	<ul style="list-style-type: none"> <li>The format of this data sheet has been redesigned to comply with the new identity guidelines of NXP Semiconductors.</li> <li>Legal texts have been adapted to the new company name where appropriate.</li> </ul>			
74ABT541 v.2	19980116	Product specification	-	74ABT541 v.1
74ABT541 v.1	19960110	Product specification	-	-

## 15. Legal information

### 15.1 Data sheet status

Document status <sup>[1][2]</sup>	Product status <sup>[3]</sup>	Definition
Objective [short] data sheet	Development	This document contains data from the objective specification for product development.
Preliminary [short] data sheet	Qualification	This document contains data from the preliminary specification.
Product [short] data sheet	Production	This document contains the product specification.

[1] Please consult the most recently issued document before initiating or completing a design.

[2] The term 'short data sheet' is explained in section "Definitions".

[3] The product status of device(s) described in this document may have changed since this document was published and may differ in case of multiple devices. The latest product status information is available on the Internet at URL <http://www.nxp.com>.

### 15.2 Definitions

**Draft** — The document is a draft version only. The content is still under internal review and subject to formal approval, which may result in modifications or additions. NXP Semiconductors does not give any representations or warranties as to the accuracy or completeness of information included herein and shall have no liability for the consequences of use of such information.

**Short data sheet** — A short data sheet is an extract from a full data sheet with the same product type number(s) and title. A short data sheet is intended for quick reference only and should not be relied upon to contain detailed and full information. For detailed and full information see the relevant full data sheet, which is available on request via the local NXP Semiconductors sales office. In case of any inconsistency or conflict with the short data sheet, the full data sheet shall prevail.

**Product specification** — The information and data provided in a Product data sheet shall define the specification of the product as agreed between NXP Semiconductors and its customer, unless NXP Semiconductors and customer have explicitly agreed otherwise in writing. In no event however, shall an agreement be valid in which the NXP Semiconductors product is deemed to offer functions and qualities beyond those described in the Product data sheet.

### 15.3 Disclaimers

**Limited warranty and liability** — Information in this document is believed to be accurate and reliable. However, NXP Semiconductors does not give any representations or warranties, expressed or implied, as to the accuracy or completeness of such information and shall have no liability for the consequences of use of such information. NXP Semiconductors takes no responsibility for the content in this document if provided by an information source outside of NXP Semiconductors.

In no event shall NXP Semiconductors be liable for any indirect, incidental, punitive, special or consequential damages (including - without limitation - lost profits, lost savings, business interruption, costs related to the removal or replacement of any products or rework charges) whether or not such damages are based on tort (including negligence), warranty, breach of contract or any other legal theory.

Notwithstanding any damages that customer might incur for any reason whatsoever, NXP Semiconductors' aggregate and cumulative liability towards customer for the products described herein shall be limited in accordance with the *Terms and conditions of commercial sale* of NXP Semiconductors.

**Right to make changes** — NXP Semiconductors reserves the right to make changes to information published in this document, including without limitation specifications and product descriptions, at any time and without notice. This document supersedes and replaces all information supplied prior to the publication hereof.

**Suitability for use** — NXP Semiconductors products are not designed, authorized or warranted to be suitable for use in life support, life-critical or safety-critical systems or equipment, nor in applications where failure or malfunction of an NXP Semiconductors product can reasonably be expected to result in personal injury, death or severe property or environmental damage. NXP Semiconductors and its suppliers accept no liability for inclusion and/or use of NXP Semiconductors products in such equipment or applications and therefore such inclusion and/or use is at the customer's own risk.

**Applications** — Applications that are described herein for any of these products are for illustrative purposes only. NXP Semiconductors makes no representation or warranty that such applications will be suitable for the specified use without further testing or modification.

Customers are responsible for the design and operation of their applications and products using NXP Semiconductors products, and NXP Semiconductors accepts no liability for any assistance with applications or customer product design. It is customer's sole responsibility to determine whether the NXP Semiconductors product is suitable and fit for the customer's applications and products planned, as well as for the planned application and use of customer's third party customer(s). Customers should provide appropriate design and operating safeguards to minimize the risks associated with their applications and products.

NXP Semiconductors does not accept any liability related to any default, damage, costs or problem which is based on any weakness or default in the customer's applications or products, or the application or use by customer's third party customer(s). Customer is responsible for doing all necessary testing for the customer's applications and products using NXP Semiconductors products in order to avoid a default of the applications and the products or of the application or use by customer's third party customer(s). NXP does not accept any liability in this respect.

**Limiting values** — Stress above one or more limiting values (as defined in the Absolute Maximum Ratings System of IEC 60134) will cause permanent damage to the device. Limiting values are stress ratings only and (proper) operation of the device at these or any other conditions above those given in the Recommended operating conditions section (if present) or the Characteristics sections of this document is not warranted. Constant or repeated exposure to limiting values will permanently and irreversibly affect the quality and reliability of the device.

**Terms and conditions of commercial sale** — NXP Semiconductors products are sold subject to the general terms and conditions of commercial sale, as published at <http://www.nxp.com/profile/terms>, unless otherwise agreed in a valid written individual agreement. In case an individual agreement is concluded only the terms and conditions of the respective agreement shall apply. NXP Semiconductors hereby expressly objects to applying the customer's general terms and conditions with regard to the purchase of NXP Semiconductors products by customer.

**No offer to sell or license** — Nothing in this document may be interpreted or construed as an offer to sell products that is open for acceptance or the grant, conveyance or implication of any license under any copyrights, patents or other industrial or intellectual property rights.

**Export control** — This document as well as the item(s) described herein may be subject to export control regulations. Export might require a prior authorization from competent authorities.

**Non-automotive qualified products** — Unless this data sheet expressly states that this specific NXP Semiconductors product is automotive qualified, the product is not suitable for automotive use. It is neither qualified nor tested in accordance with automotive testing or application requirements. NXP Semiconductors accepts no liability for inclusion and/or use of non-automotive qualified products in automotive equipment or applications.

In the event that customer uses the product for design-in and use in automotive applications to automotive specifications and standards, customer (a) shall use the product without NXP Semiconductors' warranty of the product for such automotive applications, use and specifications, and (b) whenever customer uses the product for automotive applications beyond

NXP Semiconductors' specifications such use shall be solely at customer's own risk, and (c) customer fully indemnifies NXP Semiconductors for any liability, damages or failed product claims resulting from customer design and use of the product for automotive applications beyond NXP Semiconductors' standard warranty and NXP Semiconductors' product specifications.

**Translations** — A non-English (translated) version of a document is for reference only. The English version shall prevail in case of any discrepancy between the translated and English versions.

## 15.4 Trademarks

Notice: All referenced brands, product names, service names and trademarks are the property of their respective owners.

## 16. Contact information

For more information, please visit: <http://www.nxp.com>

For sales office addresses, please send an email to: [salesaddresses@nxp.com](mailto:salesaddresses@nxp.com)

## 17. Contents

<b>1</b>	<b>General description</b> .....	<b>1</b>
<b>2</b>	<b>Features and benefits</b> .....	<b>1</b>
<b>3</b>	<b>Ordering information</b> .....	<b>1</b>
<b>4</b>	<b>Functional diagram</b> .....	<b>2</b>
<b>5</b>	<b>Pinning information</b> .....	<b>2</b>
5.1	Pinning .....	2
5.2	Pin description .....	3
<b>6</b>	<b>Functional description</b> .....	<b>3</b>
<b>7</b>	<b>Limiting values</b> .....	<b>3</b>
<b>8</b>	<b>Recommended operating conditions</b> .....	<b>4</b>
<b>9</b>	<b>Static characteristics</b> .....	<b>4</b>
<b>10</b>	<b>Dynamic characteristics</b> .....	<b>5</b>
<b>11</b>	<b>AC waveforms</b> .....	<b>6</b>
<b>12</b>	<b>Package outline</b> .....	<b>8</b>
<b>13</b>	<b>Abbreviations</b> .....	<b>12</b>
<b>14</b>	<b>Revision history</b> .....	<b>12</b>
<b>15</b>	<b>Legal information</b> .....	<b>13</b>
15.1	Data sheet status .....	13
15.2	Definitions .....	13
15.3	Disclaimers .....	13
15.4	Trademarks .....	14
<b>16</b>	<b>Contact information</b> .....	<b>14</b>
<b>17</b>	<b>Contents</b> .....	<b>15</b>

Please be aware that important notices concerning this document and the product(s) described herein, have been included in section 'Legal information'.

© NXP Semiconductors N.V. 2014.

All rights reserved.

For more information, please visit: <http://www.nxp.com>

For sales office addresses, please send an email to: [salesaddresses@nxp.com](mailto:salesaddresses@nxp.com)

Date of release: 11 August 2014

Document identifier: 74ABT541