

| | | | | |
|--------|-------------------|-----------------|------------|--|
| REV. B | EQN NO. E3-6C0092 | DATE 2006/11/22 | SIGN Cloud | DESCRIPTION Modify the Note and dimension. |
|--------|-------------------|-----------------|------------|--|

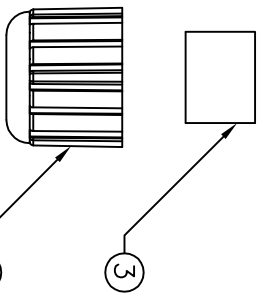
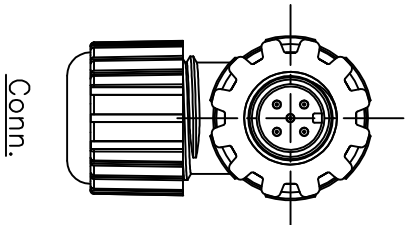
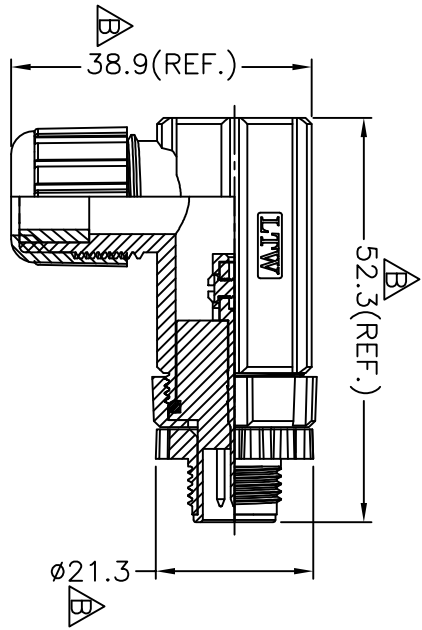
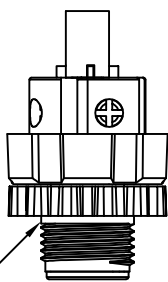
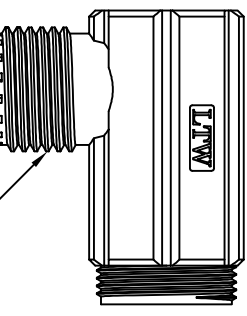
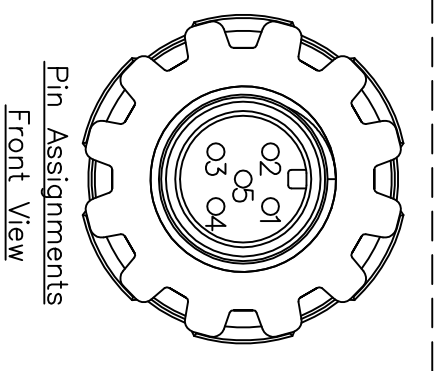
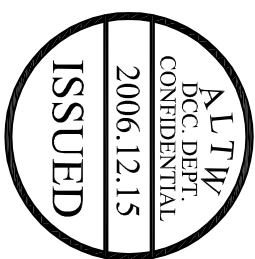
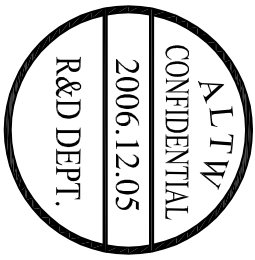

△Note:

- * Waterproof Rate : IP67
- * Connector:Black,Nylon+GF
- * Pin:Copper Alloy,Gold Plated
- * O-Ring:Black,EPDM.
- * Holder:Black,Nylon+GF
- * Insulator:Black,PVC
- * Clamp Ring:Black,Nylon 66.
- * Gasket:Black,EPDM.
- * Sealing Nut:Black,Nylon 66.
- * Nut:Black,Nylon+GF
- * Seals For Cable OD $\phi 4.5\text{mm} \sim \phi 6.0\text{mm}$
- * Temperature Range: $-40^{\circ}\text{C} \sim +85^{\circ}\text{C}$.

| | | | | | | | | | |
|-----------|--|------------------------|--|------------------|--|-------------|--|------------|--|
| UNIT:mm | | TITLE | | ITEM NO | | DRAWN BY | | DATE | |
| TOLERANCE | | M12 Screw In Male Conn | | 12P-05BMB-SR7001 | | Cloud | | 2006/12/05 | |
| .X | | 5Pin A Code | | DWG NO | | CHECKED BY | | DATE | |
| XX | | Free | | 12P-05BMB-SR7001 | | Simon Hung | | 2006/12/07 | |
| XXX | | SIZE | | CUSTOMER | | APPROVED BY | | DATE | |
| ANGLES | | A4 | | ALTW | | Max | | 2006/12/12 | |
| ±0.25 | | SHEET 1 OF 1 | | | | | | | |
| ±0.1 | | ⑩ :inspection item | | | | | | | |
| ±0.05 | | | | | | | | | |
| ±1° | | | | | | | | | |