

PCB terminal strip; 2 solder pins/pole; 4-pole; pin spacing 5/5.08 mm / 0.2 in; with push-button

Item No.: 255-404



PCB terminal strip; 2 solder pins/pole; 4-pole; pin spacing 5/5.08 mm / 0.2 in; with push-button

Marking

RoHS ✓
Compliant

Business data

Supplier	WAGO
Item no.	255-404
GTIN / EAN	4044918659048
Content	1
Order amount	50
Customer item number	

Notes

Terminal strips with push-button actuated CAGE CLAMP® Also available with Ex e approval Set to metric or inch pin spacing by compressing terminal strips together or pulling them apart Ideal for in-the-field wiring thanks to simplified push-button actuation Convenient, tool-free operation

Technical data

Miscellaneous

No. of poles	4
Pin spacing	5/5.08 mm / 0.2 in
Total number of connection points	4
Total number of potentials	4
Color	gray
Ratings according to 1	IEC/EN 60664-1
Overvoltage category EN 1	III

Technical data	
<i>Pollution degree (1)</i>	2
<i>Rated voltage EN (1) [V]</i>	320 [V]
<i>Rated surge voltage (1) [kV]</i>	4 [kV]
<i>Nominal current [A]</i>	24 [A]
<i>Overvoltage category EN 2</i>	II
<i>Degree of pollution (2)</i>	2
<i>Rated voltage EN (2) [V]</i>	630 [V]
<i>Rated surge voltage (2) [kV]</i>	4 [kV]
<i>Nominal current (2) [A]</i>	24 [A]
<i>Overvoltage category EN 3</i>	III
<i>Degree of pollution (3)</i>	3
<i>Rated voltage EN (3) [V]</i>	320 [V]
<i>Rated surge voltage (3) [kV]</i>	4 [kV]
<i>Nominal current (3) [A]</i>	24 [A]
<i>Number of individual connection objects at the product</i>	1
<i>Connection technology (1)</i>	CAGE CLAMP®
<i>Solid sizes 1</i>	0.08 ... 2.5 mm ² / 28 ... 12 AWG
<i>Fine-stranded wires 1</i>	0.08 ... 2.5 mm ² / 28 ... 12 AWG
<i>Fine-stranded wires with insulated ferrule 1</i>	0.25 ... 1.5 mm ² / ...
<i>Fine-stranded wires with uninsulated ferrule 1</i>	0.25 ... 1.5 mm ² / ...
<i>Strip length 1</i>	5 ... 6 mm / 0.2 ... 0.24 in
<i>Conductor entry angle to the PCB 1 [°]</i>	90 [°]
<i>Type of wiring</i>	Front-entry wiring
<i>Solder pin arrangement</i>	in line
<i>Solder pin length [mm]</i>	4 [mm]
<i>Solder pin width A [mm]</i>	0.7 [mm]
<i>Solder pin width B [mm]</i>	0.7 [mm]
<i>Drilled hole diameter (tolerance) [mm]</i>	1.1(+ 0.1) [mm]
<i>Material group</i>	I
<i>Insulating material</i>	Polyamide 66 (PA 66)
<i>Flammability rating per UL 94</i>	V0
<i>Limit temperature range</i>	-60 C ... 105 C
<i>Clamping spring material</i>	Chrome-nickel spring steel (CrNi)
<i>Contact material</i>	Electrolytic copper (Ecu)

Printview: PCB terminal strip; 2 solder pins/pole; 4-pole; pin spacing 5/5.08 mm / 0.2 in; with push-button -
Item No.: 255-404

Technical data	
<i>Contact plating</i>	<i>tin-plated</i>
<i>Fire load [MJ]</i>	<i>0.074 [MJ]</i>
<i>Weight [g]</i>	<i>4.78 [g]</i>
<i>Width</i>	<i>22.9 mm / 0.902 in</i>
<i>Height</i>	<i>18.2 mm / 0.717 in</i>
<i>Height from the surface</i>	<i>14.2 mm / 0.559 in</i>
<i>Length</i>	<i>18.3 mm / 0.72 in</i>

Images & drawings

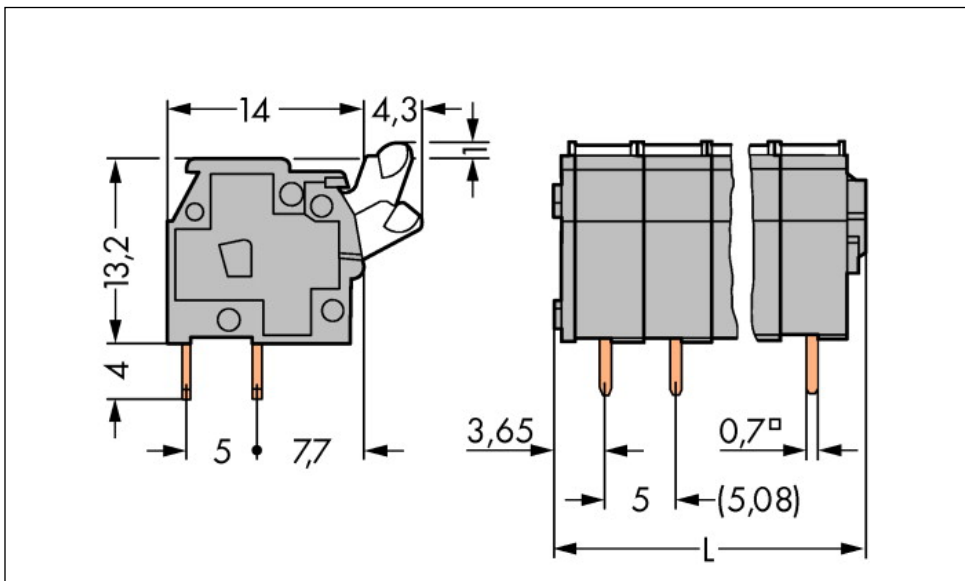
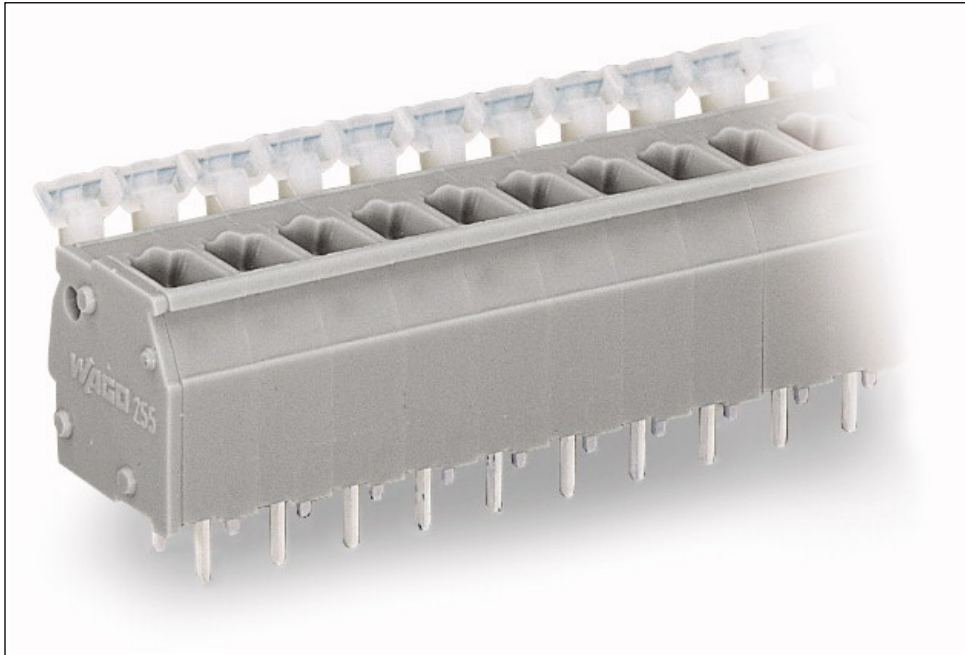

Address

WAGO Kontakttechnik GmbH & Co. KG

Hansastr. 27

32423 Minden

Telefon: 0571/887-0

Fax: 0571/887-169

<http://www.wago.com>

© WAGO Kontakttechnik GmbH & Co. KG

Technische Änderungen und Irrtümer vorbehalten.