

Mini-NPN-Silizium-Fototransistor Mini-Silicon NPN Phototransistor

SFH 305

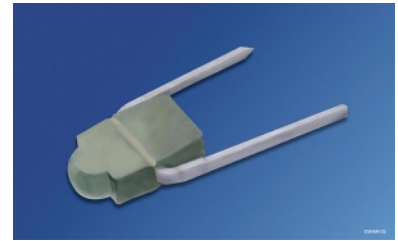

Wesentliche Merkmale

- Speziell geeignet für Anwendungen im Bereich von 460 nm bis 1060 nm
- Hohe Linearität
- Mini-Bauform
- Gruppiert lieferbar

Anwendungen

- Miniaturlichtschranken für Gleich- und Wechsellichtbetrieb
- Lochstreifenleser
- Industrieelektronik
- „Messen/Steuern/Regeln“

Features

- Especially suitable for applications from 460 nm to 1060 nm
- High linearity
- Mini-package
- Available in groups

Applications

- Miniature photointerrupters
- Punched tape reading
- Industrial electronics
- For control and drive circuits

Typ Type	Bestellnummer Ordering Code
SFH 305	Q62702-P836
SFH 305-2/3	Q62702-P3589

Grenzwerte
Maximum Ratings

Bezeichnung Parameter	Symbol Symbol	Wert Value	Einheit Unit
Betriebs- und Lagertemperatur Operating and storage temperature range	$T_{op}; T_{stg}$	- 40 ... + 80	°C
Löttemperatur bei Tauchlötung Lötstelle ≥ 2 mm vom Gehäuse, Lötzeit $t \leq 5$ s Dip soldering temperature ≥ 2 mm distance from case bottom, soldering time $t \leq 5$ s	T_S	230	°C
Löttemperatur bei Kolbenlötung Lötstelle ≥ 2 mm vom Gehäuse, Lötzeit $t \leq 3$ s Iron soldering temperature ≥ 2 mm distance from case bottom, soldering time $t \leq 3$ s	T_S	300	°C
Kollektor-Emitterspannung Collector-emitter voltage	V_{CE}	32	V
Kollektorstrom Collector current	I_C	50	mA
Kollektorspitzenstrom, $\tau < 10 \mu s$ Collector surge current	I_{CS}	200	mA
Verlustleistung, $T_A = 25 \text{ °C}$ Power dissipation	P_{tot}	70	mW
Wärmewiderstand Thermal resistance	R_{thJA}	950	K/W

Kennwerte ($T_A = 25\text{ °C}$, $\lambda = 950\text{ nm}$)

Characteristics

Bezeichnung Parameter	Symbol Symbol	Wert Value	Einheit Unit
Wellenlänge der max. Fotoempfindlichkeit Wavelength of max. sensitivity	$\lambda_{S\text{ max}}$	850	nm
Spektraler Bereich der Fotoempfindlichkeit $S = 10\%$ von S_{max} Spectral range of sensitivity $S = 10\%$ of S_{max}	λ	460 ... 1060	nm
Bestrahlungsempfindliche Fläche Radiant sensitive area	A	0.17	mm ²
Abmessungen der Chipfläche Dimensions of chip area	$L \times B$ $L \times W$	0.6×0.6	mm \times mm
Abstand Chipoberfläche zu Gehäuseoberfläche Distance chip front to case surface	H	1.3 ... 1.9	mm
Halbwinkel Half angle	φ	± 16	Grad deg.
Kapazität Capacitance $V_{\text{CE}} = 0\text{ V}$, $f = 1\text{ MHz}$, $E = 0$	C_{CE}	5.5	pF
Dunkelstrom Dark current $V_{\text{CE}} = 25\text{ V}$, $E = 0$	I_{CEO}	3 (≤ 20)	nA

Die Fototransistoren werden nach ihrer Fotoempfindlichkeit gruppiert und mit arabischen Ziffern gekennzeichnet.

The phototransistors are grouped according to their spectral sensitivity and distinguished by arabian figures.

Bezeichnung Parameter	Symbol Symbol	Wert Value		Einheit Unit
		-2	-3	
Fotostrom, $\lambda = 950 \text{ nm}$ Photocurrent $E_e = 0.5 \text{ mW/cm}^2$, $V_{CE} = 5 \text{ V}$ $E_v = 1000 \text{ lx}$, Normlicht/standard light A, $V_{CE} = 5 \text{ V}$	I_{PCE} I_{PCE}	0.25 ... 0.5 1.4	0.4 ... 0.8 2.2	mA mA
Anstiegszeit/Abfallzeit Rise and fall time $I_C = 1 \text{ mA}$, $V_{CC} = 5 \text{ V}$, $R_L = 1 \text{ k}\Omega$	t_r , t_f	5.5	6	μs
Kollektor-Emitter-Sättigungsspannung Collector-emitter saturation voltage $I_C = I_{PCEmin}^{1)} \times 0.3$, $E_e = 0.5 \text{ mW/cm}^2$	V_{CEsat}	150	150	mV

¹⁾ I_{PCEmin} ist der minimale Fotostrom der jeweiligen Gruppe.

¹⁾ I_{PCEmin} is the min. photocurrent of the specified group.

Relative Spectral Sensitivity

$S_{rel} = f(\lambda)$

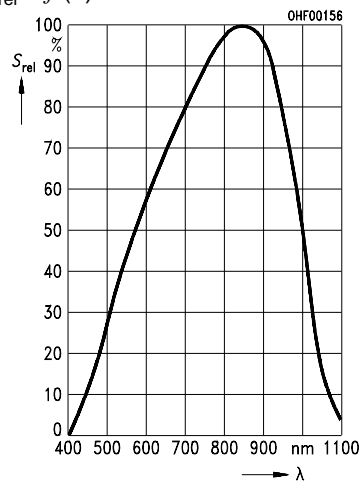

Photocurrent

$I_{PCE} = f(E_e), V_{CE} = 5 V$

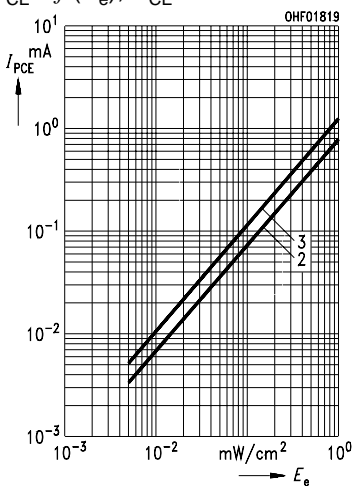

Total Power Dissipation

$P_{tot} = f(T_A)$

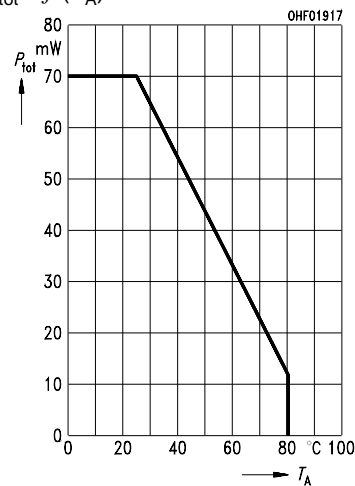

Photocurrent

$I_{PCE} / I_{PCE 25^\circ} = f(T_A), V_{CE} = 5 V$

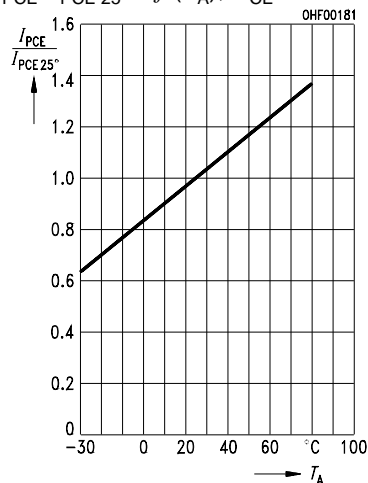

Collector-Emitter Capacitance

$C_{CE} = f(V_{CE}), f = 1 MHz, E = 0$

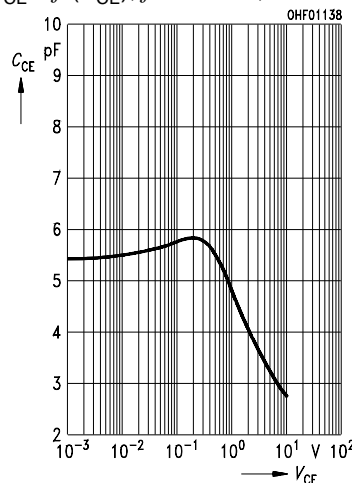

Dark Current

$I_{CEO} = f(T_A), V_{CE} = 25 V, E = 0$

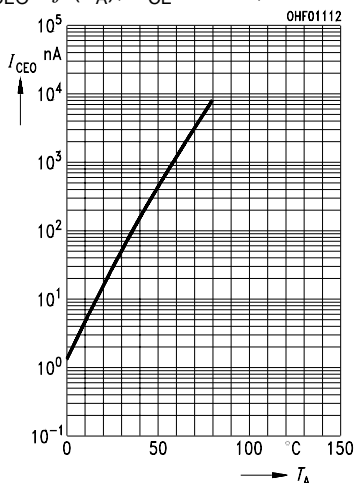

Directional Characteristics

$S_{rel} = f(\varphi)$

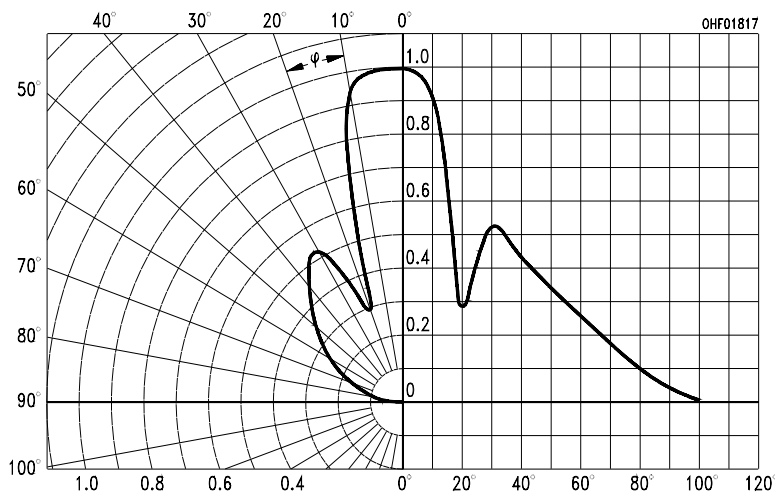

Maßzeichnung Package Outlines

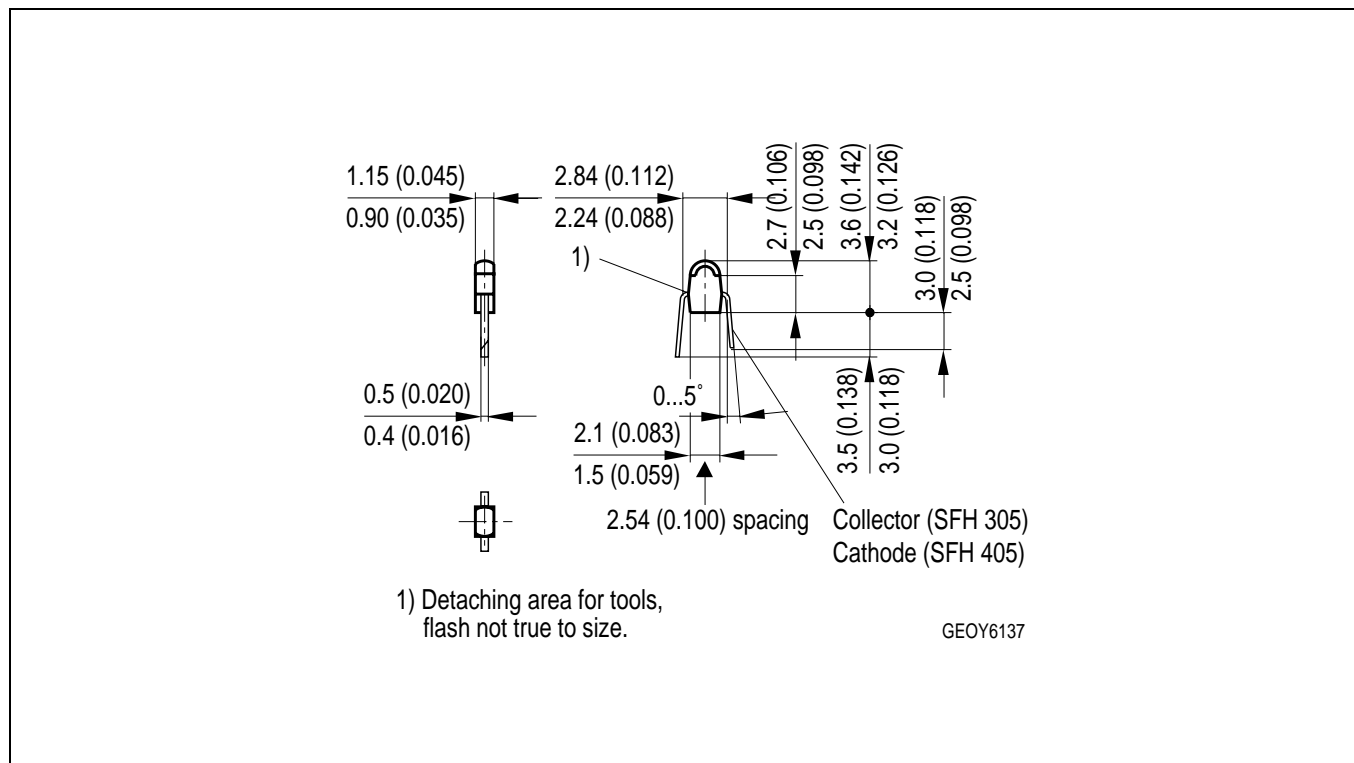

Maße werden wie folgt angegeben: mm (inch) / Dimensions are specified as follows: mm (inch).

Published by OSRAM Opto Semiconductors GmbH & Co. OHG

Wernerwerkstrasse 2, D-93049 Regensburg

© All Rights Reserved.

Attention please!

The information describes the type of component and shall not be considered as assured characteristics.

Terms of delivery and rights to change design reserved. Due to technical requirements components may contain dangerous substances. For information on the types in question please contact our Sales Organization.

Packing

Please use the recycling operators known to you. We can also help you – get in touch with your nearest sales office. By agreement we will take packing material back, if it is sorted. You must bear the costs of transport. For packing material that is returned to us unsorted or which we are not obliged to accept, we shall have to invoice you for any costs incurred.

Components used in life-support devices or systems must be expressly authorized for such purpose! Critical components¹, may only be used in life-support devices or systems² with the express written approval of OSRAM OS.

¹ A critical component is a component used in a life-support device or system whose failure can reasonably be expected to cause the failure of that life-support device or system, or to affect its safety or effectiveness of that device or system.

² Life support devices or systems are intended (a) to be implanted in the human body, or (b) to support and/or maintain and sustain human life. If they fail, it is reasonable to assume that the health of the user may be endangered.